

Instructor's Solutions Manual for

ELEMENTARY

Linear Algebra

Stanley I. Grossman

Fifth Edition

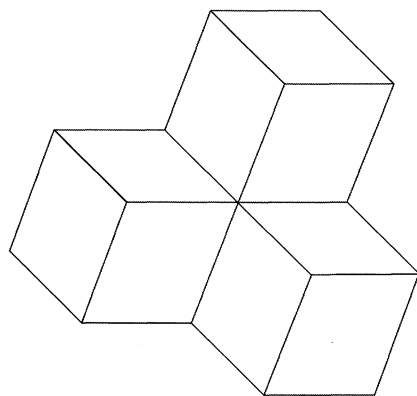

Andy Demetre
Fred Gyls-Colwell
David Ragozin

UNIVERSITY OF WASHINGTON

THOMSON
★
BROOKS/COLE

Australia • Canada • Mexico • Singapore
Spain • United Kingdom • United States

COPYRIGHT © 1994 Brooks/Cole, a division of Thomson Learning, Inc.
Thomson Learning™ is a trademark used herein under license.

ALL RIGHTS RESERVED. No part of this work covered by the copyright hereon may be reproduced or used in any form or by any means — graphic, electronic, or mechanical, including photocopying, recording, taping, Web distribution, or information storage or retrieval systems — without the written permission of the publisher.

MATLAB® is a registered trademark of The MathWorks, Inc.

Brooks/Cole — Thomson Learning
10 Davis Drive
Belmont CA 94002-3098
USA

For information about our products, contact us:
Thomson Learning Academic Resource Center
1-800-423-0563
<http://www.wadsworth.com>

For permission to use material from this text, contact us by
Web: <http://www.thomsonrights.com>
Fax: 1-800-730-2215
Phone: 1-800-730-2214

Ragozin: Instructor's Solutions Manual to accompany
Elementary Linear Algebra, 5e, by Grossman

ISBN 0-03-097355-4

Printed in the United States of America

10 9 8 7 6 5 4 3 2 1

Preface

This Instructor's Solutions Manual is an ancillary for the fifth edition of Grossman's *Elementary Linear Algebra*. It contains detailed solutions to all problems in the text—including the MATLAB and graphing calculator problems—and in the Applications Supplement. Below is an overview of all the ancillaries to accompany the main text.

Applications Supplement

- one chapter each on linear programming and on Markov chains and game theory
- available packaged with the text or for separate purchase
- numerous examples and problems
- answers to odd-numbered problems are at the back of the Applications Supplement

Student Solutions Manual

- complete solutions to all the odd-numbered problems in the text and the Applications Supplement

MATLAB Manual: Computer Laboratory Exercises and M-file disk

- computer laboratory exercises and applications using MATLAB. Each section lists objectives, prerequisites, and MATLAB features before the lab exercise is presented. The student is then encouraged to apply concepts interactively and create an edited diary session. An M-file disk containing programs of selected applications in the manual is available free upon request from The MathWorks, Inc., in either Mac or PC versions.

Elementary Linear Algebra Toolbox (M-file disk)

- MATLAB programs that accompany the main text in either PC or Mac version are available free upon request from The MathWorks, Inc.

HP-48G/GX Calculator Manual

- calculator enhancement for science and engineering mathematics using the high-level Hewlett-Packard calculator

Acknowledgments

This Instructor's Solutions Manual has been prepared with the help of many people. The solutions to the fourth edition problems were prepared by Rick Miranda of Colorado State University, with the assistance of Howard Thompson and John Symms. These provide the basis for much of the present work. Andy Demetre prepared the solutions for the new problems in the main body of the text. Fred Gylys-Colwell developed the solutions for the MATLAB problems in Chapters 1 and 4. David Ragozin provided the solutions for the MATLAB problems in Chapters 5 and 6, the CALCULATOR box solutions for the TI-85, and the editorial changes and updated solutions found throughout the rest of the manual. Michael Ragozin assisted with the TI-85 solutions.

Mary Sheets produced the TEX files for the manual. The new figures were produced by Fred Gylys-Colwell and David Ragozin using MATLAB, S-Plus, and TI-85 Graph Link.

Andy Demetre
Fred Gylys-Colwell
David L. Ragozin
Seattle, Washington
March 1994

Table of Contents

Chapter 1.	Systems of Linear Equations and Matrices	1
1.2	Two Linear Equations in Two Unknowns	1
1.3	m Equations in n unknowns: Gauss-Jordan and Gaussian Elimination	6
1.4	Homogeneous Systems of Equations	36
1.5	Vectors and Matrices	42
1.6	Vector and Matrix Products	49
1.7	Matrices and Linear Systems of Equations	78
1.8	The Inverse of a Square Matrix	88
1.9	The Transpose of a Matrix	113
1.10	Elementary Matrices and Matrix Inverses	120
1.11	LU-Factorizations of a Matrix	134
1.12	Graph Theory: An Application of Matrices	154
	Review Exercises for Chapter 1	156
Chapter 2.	Determinants	165
2.1	Definitions	165
2.2	Properties of Determinants	182
2.3	Proofs of Three Important Theorems and Some History	191
2.4	Determinants and Inverses	192
2.5	Cramer's Rule	198
	Review Exercises for Chapter 2	202
Chapter 3.	Vectors in \mathbb{R}^2 and \mathbb{R}^3	205
3.1	Vectors in the Plane	205
3.2	The Scalar Product and Projections in \mathbb{R}^2	215
3.3	Vectors in Space	223
3.4	The Cross Product of Two Vectors	226
3.5	Lines and Planes in Space	235
	Review Exercises for Chapter 3	240

Chapter 4.	Vector Spaces	245
4.2	Definition and Basic Properties	245
4.3	Subspaces	250
4.4	Linear Combination and Span	253
4.5	Linear Independence	268
4.6	Bases and Dimension	294
4.7	The Rank, Nullity, Row Space and Column Space of a Matrix	308
4.8	Change of Basis	350
4.9	Orthonormal Bases and Projections in \mathbb{R}^n	367
4.10	Least Squares Approximation	390
4.11	Inner Product Spaces and Projections	407
4.12	The Foundations of Vector Space Theory: The Existence of a Basis	416
	Review Exercises for Chapter 4	417
Chapter 5.	Linear Transformations	423
5.1	Definitions and Examples	423
5.2	Properties of a Linear Transformation: Range and Kernel	426
5.3	The Matrix Representation of a Linear Transformation	428
5.4	Isomorphisms	435
5.5	Isometries	437
	Review Exercises for Chapter 5	440
Chapter 6.	Eigenvalues, Eigenvectors and Canonical Forms	443
6.1	Eigenvalues and Eigenvectors	443
6.2	A Model of Population Growth	477
6.3	Similar Matrices and Diagonalization	488
6.4	Symmetric Matrices and Orthogonal Diagonalization	500
6.5	Quadratic Forms and Conic Sections	507
6.6	Jordan Canonical Form	515
6.7	An Important Application: Matrix Differential Equations	519
6.8	A Different Perspective: The Theorems of Cayley-Hamilton and Gershgorin	523
	Review Exercises for Chapter 6	535

Appendices	539
1. Mathematical Induction	539
2. Complex Numbers	543
3. The Error in Numerical Computations and Computational Complexity	545
4. Gaussian Elimination with Pivoting	547
Application 1. Linear Programming	551
1.1 Convex Sets and Linear Inequalities	551
1.2 Linear Programming, The Corner Point Method	559
1.3 Slack Variables	563
1.4 The Simplex Method I: The Standard Maximizing Problem	565
1.5 The Simplex Method II: The Dual Minimum Problem	572
1.6 The Simplex Method III: Finding a Feasible Solution	576
Review Exercises for Application 1	578
Application 2. Markov Chains and Game Theory	585
2.1 Two-Person Games: Pure Strategies	585
2.2 Two-Person Games: Mixed Strategies	587
2.3 Matrix Games and Linear Programming	590
2.4 Markov Chains	594
2.5 Absorbing Markov Chains	597
2.6 Queuing Theory and a Model in Psychology	600
Review Exercises for Application 2	602

Chapter 1. Systems of Linear Equations and Matrices

Section 1.2

$$1. \quad \begin{array}{r} 4x - 12y = 16 \\ -4x + 2y = 6 \\ \hline \end{array}$$

$$-10y = 22 \text{ hence, } y = -11/5 \text{ and } x = -13/5.$$

$$a_{11}a_{22} - a_{12}a_{21} = (1)(2) - (-3)(-4) = 2 - 12 = -10.$$

$$2. \quad \begin{array}{r} 14x - 7y = -21 \\ 5x + 7y = 4 \\ \hline \end{array}$$

$$19x = -17 \text{ hence, } x = -17/19 \text{ and } y = 3 + 2x = 3 - 34/19 = 23/19.$$

$$a_{11}a_{22} - a_{12}a_{21} = (2)(7) - (-1)(5) = 14 - (-5) = 19.$$

$$3. \quad \begin{array}{r} 6x - 24y = 15 \\ -6x + 24y = 16 \\ \hline \end{array}$$

$$0 = 31 \Rightarrow \text{no solution.}$$

$$a_{11}a_{22} - a_{12}a_{21} = (2)(12) - (-8)(-3) = 24 - 24 = 0.$$

$$4. \quad \begin{array}{r} 6x - 24y = 18 \\ -6x + 24y = -18 \\ \hline \end{array}$$

$$0 = 0 \Rightarrow \text{lines coincide.}$$

$$a_{11}a_{22} - a_{12}a_{21} = (2)(12) - (-8)(-3) = 24 - 24 = 0.$$

$$5. \quad \begin{array}{r} 6x + y = 3 \\ -4x - y = 8 \\ \hline \end{array}$$

$$2x = 11 \text{ hence, } x = 11/2 \text{ and } y = 3 - 6x = 3 - 33 = -30.$$

$$a_{11}a_{22} - a_{12}a_{21} = (6)(-1) - (1)(-4) = -6 - (-4) = -2.$$

$$6. \quad \begin{array}{r} 9x + 3y = 0 \\ 2x - 3y = 0 \\ \hline \end{array}$$

$$11x = 0 \text{ hence, } x = 0 \text{ and } y = -3x = 0.$$

$$a_{11}a_{22} - a_{12}a_{21} = (3)(-3) - (1)(2) = -9 - 2 = -11.$$

$$7. \quad \begin{array}{r} 4x - 6y = 0 \\ -4x + 6y = 0 \\ \hline \end{array}$$

$$0 = 0 \Rightarrow \text{lines coincide; } 4x - 6y = 0 \text{ implies } y = (2/3)x \text{ for arbitrary } x.$$

$$a_{11}a_{22} - a_{12}a_{21} = (4)(3) - (-6)(-2) = 12 - 12 = 0.$$

$$8. \quad \begin{array}{r} 25x + 10y = 15 \\ 4x + 10y = 6 \\ \hline \end{array}$$

$$21x = 9 \text{ hence, } x = 9/21 \text{ and } y = (3 - 5x)/2 = 9/21.$$

$$a_{11}a_{22} - a_{12}a_{21} = (5)(5) - (2)(2) = 25 - 4 = 21.$$

9. $8x + 12y = 16$

$9x + 12y = 15$

$$\begin{array}{r} -x \\ \hline \end{array} = 1 \text{ hence, } x = -1 \text{ and } y = (4 - 2x)/3 = 2.$$

$$a_{11}a_{22} - a_{12}a_{21} = (2)(4) - (3)(3) = 8 - 9 = -1.$$

10. $ax + by = c$

$ax - by = c$

$$\begin{array}{r} 2ax \\ \hline \end{array} = 2c \text{ hence, } x = c/a \text{ (assuming } a \neq 0) \text{ and } y = (c - ax)/b = 0$$

(assuming $b \neq 0$). If $a = 0$ and $b \neq 0$, then there are no solutions unless $c = 0$, in which case $y = 0$ and any x is a solution. If $a \neq 0$ and $b = 0$, then $x = c/a$ and any y is a solution. Finally, if both a and b are zero, then there are no solutions unless $c = 0$, too, in which case any x and y gives a solution. $a_{11}a_{22} - a_{12}a_{21} = a(-b) - ba = -2ab$.

11. $a^2x + aby = ac$

$b^2x + aby = bc$

$$\begin{array}{r} (a^2 - b^2)x = ac - bc \\ \hline \end{array} \text{ hence, } x = c(a - b)/(a^2 - b^2) = c/(a + b)$$

(assuming $a^2 - b^2 \neq 0$) and $y = (c - ax)/b = c/(a + b)$ also. If $a^2 - b^2 = 0$, then $a = \pm b$; if $a = b \neq 0$, then the equations are the same, and $y = (c/a) - x$ and any x gives a solution. If $a = -b$, then there are no solutions unless $c = 0$, in which case any x and y give a solution if $b = 0$, and if $b \neq 0$, $y = x$ with any x gives a solution. $a_{11}a_{22} - a_{12}a_{21} = aa - bb = a^2 - b^2$.

12. $a^2x - aby = ac$

$b^2x + aby = bd$

$$\begin{array}{r} (a^2 + b^2)x = ac + bc \\ \hline \end{array} \text{ hence, } x = (ac + bd)/(a^2 + b^2)$$

(assuming $a \neq 0$ and $b \neq 0$) and $y = (d - bx)/a = ad - bc$.

$$a_{11}a_{22} - a_{12}a_{21} = aa - (-b)b = a^2 + b^2.$$

13. We need $-ab - ab = -2ab \neq 0$. Therefore, we need $a \neq 0$ and $b \neq 0$.

14. We need $a^2 - b^2 = 0$. Therefore, $a = b$ or $a = -b$. If $a = b$, then c can be any real number; if $a = -b$, then only $c = 0$ gives a solution.

15. We need $a^2 + b^2 = 0$. Therefore, $a = 0$ and $b = 0$. We would also need either c or d to be non-zero.

16. $3x - 3y = 21$

$2x + 3y = 1$

$$\begin{array}{r} 5x \\ \hline \end{array} = 22 \text{ hence, } x = 22/5 \text{ and } y = (1 - 2x)/2 = -13/5.$$

$$17. \begin{array}{r} -4x + 2y = 8 \\ 4x - 2y = 6 \\ \hline \end{array}$$

$0 = 14 \Rightarrow$ no point of intersection.

$$18. \begin{array}{r} 12x - 18y = 21 \\ 12x - 18y = 24 \\ \hline \end{array}$$

$0 = -3 \Rightarrow$ no point of intersection.

$$19. \begin{array}{r} 12x - 18y = 30 \\ 12x - 18y = 30 \\ \hline \end{array}$$

$0 = 0 \Rightarrow$ lines coincide.

$$20. \begin{array}{r} 3x + y = 4 \\ -5x + y = 2 \\ \hline \end{array}$$

$8x = 2$ hence, $x = 1/4$ and $y = 4 - 3x = 13/4$.

$$21. \begin{array}{r} 6x + 8y = 10 \\ 6x - 7y = 8 \\ \hline \end{array}$$

$15y = 2$ hence, $y = 2/15$ and $x = (5 - 4y)/3 = 67/45$.

22. Let $m_1 =$ the slope of L and $m_2 =$ the slope of L_\perp .

$m_1 = 1; m_2 = -1$. $L : x - y = 6$, and $L_\perp : x + y = 0$

Point of intersection: $(3, -3)$. $d = \sqrt{(3-0)^2 + (-3-0)^2} = 3\sqrt{2}$

23. $m_1 = -2/3; m_2 = 3/2$. $L : 2x + 3y = -1$, and $L_\perp : 2x + 3y = 0$

Point of intersection: $(-2/13, -3/13)$

$d = \sqrt{(-2/13-0)^2 + (-3/13-0)^2} = \sqrt{1/13}$

24. $m_1 = -3; m_2 = 1/3$. $L : 3x + y = 7$, and $L_\perp : x - 3y = -5$

Point of intersection: $(8/5, 11/5)$

$d = \sqrt{(8/5-1)^2 + (11/5-2)^2} = \sqrt{2/5}$

25. $m_1 = 5/6; m_2 = -6/5$. $L : 5x - 6y = 3$, and $L_\perp : 6x + 5y = 28$

Point of intersection: $(3, 2)$

$d = \sqrt{(3-2)^2 + (2-16/5)^2} = \sqrt{61/25}$

26. $m_1 = 5/2; m_2 = -2/5$. $L : -5x + 2y = -2$, and $L_\perp : 2x + 5y = -5$

Point of intersection: $(0, -1)$

$d = \sqrt{(5-0)^2 + (-3+1)^2} = \sqrt{29}$

27. $m_1 = -1/2$; $m_2 = 2$. $L : 3x + 6y = 3$, and $L_\perp : 2x - y = 17$

Point of intersection: $(7, -3)$

$$d = \sqrt{(8-7)^2 + (-1+3)^2} = \sqrt{5}$$

28. $4x - 6y = 2$

$$\frac{3x + 6y = 12}{\quad}$$

$$7x = 14 \text{ hence, } x = 2 \text{ and } y = (12 - 3x)/6 = 1.$$

Then, we need the distance between $(2, 1)$ and $2x - y = 6$.

$$m_1 = 2; m_2 = -1/2. L : 2x - y = 6, \text{ and } L_\perp : x + 2y = 4$$

Point of intersection: $(16/5, 2/5)$

$$d = \sqrt{(6/5 - 2)^2 + (2/5 - 1)^2} = 3\sqrt{5}/5$$

29. $m_1 = -a/b$; $m_2 = b/a$. $L : ax + by = c$, and $L_\perp : ax + by = bx_1 - ay_1$

$$\text{Point of intersection: } \left(\frac{ac + b^2x_1 - aby_1}{a^2 + b^2}, \frac{bc - abx_1 + a_2^2y_1}{a^2 + b^2} \right)$$

Then $d = |ax_1 + by_1 - c|/\sqrt{a^2 + b^2}$ after a lot of algebra.

30. Let x = number of birds and y = number of beasts.

$$\text{Then } x + y = 60;$$

$$2x + 4y = 200. \text{ Hence } x = 20 \text{ and } y = 40.$$

31. If $a_{11}a_{22} - a_{12}a_{21} = 0$, then $a_{11}a_{22} = a_{12}a_{21}$. Assuming $a_{12}a_{22} \neq 0$, and dividing both sides of the equation by $a_{12}a_{22}$ we get $a_{11}/a_{12} = a_{21}/a_{22}$. This implies $-a_{11}/a_{12} = -a_{21}/a_{22}$. Solving each linear equation of system (1) for y we get $y = -a_{11}/a_{12}x + b_1/a_{12}$ and $y = -a_{21}/a_{22}x + b_2/a_{22}$. These lines have slope $-a_{11}/a_{12}$ and $-a_{21}/a_{22}$ respectively. Slopes are equal. Therefore the lines are parallel. If $a_{12} = 0$, then from $a_{11}a_{22} = 0$ and $a_{11} \neq 0$, we get $a_{22} = 0$. So the lines are parallel because they are both vertical. If $a_{22} = 0$ similar reasoning holds.

32. Suppose otherwise, i.e., suppose that $a_{11}a_{22} - a_{12}a_{21} = 0$. Then #31 shows that the lines given in system (1) are parallel. Thus system (1) either has an infinite number of solutions or no solution. This contradicts the assumption that the system has a unique solution. Result follows.

33. If $a_{11}a_{22} - a_{12}a_{21} \neq 0$ then $a_{11}a_{22} \neq a_{12}a_{21}$. Dividing both sides of the equation by $a_{12}a_{22}$ we get $a_{11}/a_{12} \neq a_{21}/a_{22}$. Thus $-a_{11}/a_{12} \neq -a_{21}/a_{22}$. Hence the slopes of the lines in system (1) are not equal (see solution to #31). Thus the lines are not parallel. Therefore system (1) has a unique solution.

34. Let x = number of cups and y = number of saucers.

$$\begin{aligned} \text{Then, } 3x + 2y &= 480 & \text{Eq. 2} - 10 \text{ Eq. 1: } -5x &= -400 \\ 25x + 20y &= 4400; \\ \text{hence, } x &= 80 \text{ and } y = 120. \end{aligned}$$

35. $3x + 2y = 480$ Eq. 2 -5 Eq. 1: $0 = 0$
 $15x + 10y = 2400$.

So, these two lines coincide; hence $y = (480 - 3x)/2$ where $0 \leq x \leq 160$, to force $y \geq 0$.

36. $3x + 2y = 480$. Eq. 2 -5 Eq. 1: $0 = 100$,
 $15x + 10y = 2500$
so this system of equations has no solution.

37. Let x = number of ice-cream sodas and y = number of milk shakes.

$$\begin{aligned} \text{Then, } x + y &= 160; & \text{Eq. 2} - 4 \text{ Eq. 1: } -y &= -128. \\ 4x + 3y &= 512 \\ \text{Hence, } y &= 128, x = 160 - y = 32. \end{aligned}$$

Section 1.3

$$1. \begin{pmatrix} 1 & -2 & 3 & | & 11 \\ 4 & 1 & -1 & | & 4 \\ 2 & -1 & 3 & | & 10 \end{pmatrix} \xrightarrow{\substack{R_2 \rightarrow -4R_1 + R_2 \\ R_3 \rightarrow -2R_1 + R_3}} \begin{pmatrix} 1 & -2 & 3 & | & 11 \\ 0 & 9 & -13 & | & -40 \\ 0 & 3 & -3 & | & -12 \end{pmatrix} \xrightarrow{R_3 \rightarrow \frac{1}{3}R_3} \begin{pmatrix} 1 & -2 & 3 & | & 11 \\ 0 & 1 & -1 & | & -4 \\ 0 & 9 & -13 & | & -40 \end{pmatrix}$$

$$\xrightarrow{\substack{R_1 \rightarrow 2R_2 + R_1 \\ R_3 \rightarrow -9R_1 + R_3}} \begin{pmatrix} 1 & 0 & 1 & | & 3 \\ 0 & 1 & -1 & | & -4 \\ 0 & 0 & -4 & | & -4 \end{pmatrix} \xrightarrow{\substack{R_3 \rightarrow -\frac{1}{4}R_3 \\ R_2 \rightarrow R_3 + R_2 \\ R_1 \rightarrow -R_3 + R_1}} \begin{pmatrix} 1 & 0 & 0 & | & 2 \\ 0 & 1 & 0 & | & -3 \\ 0 & 0 & 1 & | & 1 \end{pmatrix}. (2, -3, 1) \text{ is the unique solution.}$$

$$2. \begin{pmatrix} -2 & 1 & 6 & | & 18 \\ 5 & 0 & 8 & | & -16 \\ 3 & 2 & -10 & | & -3 \end{pmatrix} \xrightarrow{\substack{R_3 \rightarrow R_1 + R_3 \\ R_1 \leftrightarrow R_3}} \begin{pmatrix} 1 & 3 & -4 & | & 15 \\ 5 & 0 & 8 & | & -16 \\ -2 & 1 & 6 & | & 18 \end{pmatrix} \xrightarrow{\substack{R_2 \rightarrow -5R_1 + R_2 \\ R_3 \rightarrow 2R_1 + R_3}} \begin{pmatrix} 1 & 3 & -4 & | & 15 \\ 0 & -15 & 28 & | & -91 \\ 0 & 7 & -2 & | & 48 \end{pmatrix}$$

$$\xrightarrow{\substack{R_2 \rightarrow 2R_3 + R_2 \\ R_2 \leftrightarrow R_3}} \begin{pmatrix} 1 & 3 & -4 & | & 15 \\ 0 & 1 & -24 & | & -5 \\ 0 & 7 & -2 & | & 48 \end{pmatrix} \xrightarrow{R_3 \rightarrow -7R_2 + R_3} \begin{pmatrix} 1 & 3 & -4 & | & 15 \\ 0 & 1 & -24 & | & -5 \\ 0 & 0 & 1 & | & 0.5 \end{pmatrix}. \text{ Use back substitution to}$$

find the solution $(-4, 7, \frac{1}{2})$.

$$3. \begin{pmatrix} 3 & 6 & -6 & | & 9 \\ 2 & -5 & 4 & | & 6 \\ -1 & 16 & -14 & | & -3 \end{pmatrix} \xrightarrow{\substack{R_1 \rightarrow \frac{1}{3}R_1 \\ R_2 \rightarrow -2R_1 + R_2 \\ R_3 \rightarrow R_1 + R_3}} \begin{pmatrix} 1 & 2 & -2 & | & 3 \\ 0 & -9 & 8 & | & 0 \\ 0 & 18 & -16 & | & 0 \end{pmatrix} \xrightarrow{\substack{R_3 \rightarrow 2R_2 + R_3 \\ R_2 \rightarrow -\frac{1}{9}R_2}} \begin{pmatrix} 1 & 2 & -2 & | & 3 \\ 0 & 1 & -8/9 & | & 0 \\ 0 & 0 & 0 & | & 0 \end{pmatrix}. \text{ Let } x_3$$

be arbitrary. Use back substitution to find the solutions $(3 + \frac{2}{9}x_3, \frac{8}{9}x_3, x_3)$.

$$4. \begin{pmatrix} 3 & 6 & -6 & | & 9 \\ 2 & -5 & 4 & | & 6 \\ 5 & 28 & -26 & | & -8 \end{pmatrix} \xrightarrow{\substack{R_1 \rightarrow \frac{1}{3}R_1 \\ R_2 \rightarrow -2R_1 + R_2 \\ R_3 \rightarrow -5R_1 + R_3}} \begin{pmatrix} 1 & 2 & -2 & | & 3 \\ 0 & -9 & 8 & | & 0 \\ 0 & 18 & -16 & | & -23 \end{pmatrix} \xrightarrow{R_3 \rightarrow 2R_2 + R_3} \begin{pmatrix} 1 & 2 & -2 & | & 3 \\ 0 & -9 & 8 & | & 0 \\ 0 & 0 & 0 & | & -23 \end{pmatrix}. \text{ The bot-}$$

tom row is equivalent to the equation $0 = 23$, which is impossible. So the system has no solution.

$$5. \begin{pmatrix} 1 & 1 & -1 & | & 7 \\ 4 & -1 & 5 & | & 4 \\ 2 & 2 & -3 & | & 0 \end{pmatrix} \xrightarrow{\substack{R_2 \rightarrow -4R_1 + R_2 \\ R_3 \rightarrow -2R_1 + R_3}} \begin{pmatrix} 1 & 1 & -1 & | & 7 \\ 0 & -5 & 9 & | & -24 \\ 0 & 0 & -1 & | & -14 \end{pmatrix} \xrightarrow{\substack{R_3 \rightarrow -R_3 \\ R_2 \rightarrow -9R_3 + R_2 \\ R_1 \rightarrow R_3 + R_1}} \begin{pmatrix} 1 & 1 & 0 & | & 21 \\ 0 & -5 & 0 & | & -150 \\ 0 & 0 & 1 & | & 14 \end{pmatrix}$$

$$\xrightarrow{\substack{R_2 \rightarrow -\frac{1}{5}R_2 \\ R_1 \rightarrow -R_2 + R_1}} \begin{pmatrix} 1 & 0 & 0 & | & -9 \\ 0 & 1 & 0 & | & 30 \\ 0 & 0 & 1 & | & 14 \end{pmatrix}. (-9, 30, 14) \text{ is the unique solution.}$$

$$6. \begin{pmatrix} 1 & 1 & -1 & | & 7 \\ 4 & -1 & 5 & | & 4 \\ 6 & 1 & 3 & | & 18 \end{pmatrix} \xrightarrow{\substack{R_2 \rightarrow -4R_1 + R_2 \\ R_3 \rightarrow -6R_1 + R_3}} \begin{pmatrix} 1 & 1 & -1 & | & 7 \\ 0 & -5 & 9 & | & -24 \\ 0 & -5 & 9 & | & -24 \end{pmatrix} \xrightarrow{\substack{R_3 \rightarrow -R_2 + R_3 \\ R_2 \rightarrow -\frac{1}{5}R_2 \\ R_1 \rightarrow -R_2 + R_1}} \begin{pmatrix} 1 & 0 & 4/5 & | & 12/5 \\ 0 & 1 & -9/5 & | & 24/5 \\ 0 & 0 & 0 & | & 0 \end{pmatrix}. \text{ Let } x_3$$

be arbitrary. Then $(\frac{11}{5} - \frac{4}{5}x_3, \frac{24}{5} + \frac{9}{5}x_3, x_3)$ are the solutions.

7. $\left(\begin{array}{ccc|c} 1 & 1 & -1 & 7 \\ 4 & -1 & 5 & 4 \\ 6 & 1 & 3 & 20 \end{array}\right)$. The same row operations as in problem 6 gives the equivalent matrix $\left(\begin{array}{ccc|c} 1 & 0 & 4/5 & 0 \\ 0 & 1 & -9/5 & 0 \\ 0 & 0 & 0 & 1 \end{array}\right)$. Since $0 \neq 1$, the system has no solution.

8. $\left(\begin{array}{ccc|c} 1 & -2 & 3 & 0 \\ 4 & 1 & -1 & 0 \\ 2 & -1 & 3 & 0 \end{array}\right) \xrightarrow{\substack{R_2 \rightarrow -4R_1 + R_2 \\ R_3 \rightarrow -2R_1 + R_3}} \left(\begin{array}{ccc|c} 1 & -2 & 3 & 0 \\ 0 & 9 & -13 & 0 \\ 0 & 3 & -3 & 0 \end{array}\right) \xrightarrow{\substack{R_3 \rightarrow \frac{1}{3}R_3 \\ R_2 \leftrightarrow R_3}} \left(\begin{array}{ccc|c} 1 & -2 & 3 & 0 \\ 0 & 3 & -3 & 0 \\ 0 & 9 & -13 & 0 \end{array}\right) \xrightarrow{R_1 \rightarrow 2R_2 + R_1} \left(\begin{array}{ccc|c} 1 & -2 & 3 & 0 \\ 0 & 3 & -3 & 0 \\ 0 & 0 & 1 & 0 \end{array}\right)$. $(0, 0, 0)$ is the unique solution, by back substitution.

9. $\left(\begin{array}{ccc|c} 1 & 1 & -1 & 0 \\ 4 & -1 & 5 & 0 \\ 6 & 1 & 3 & 0 \end{array}\right) \xrightarrow{\substack{R_2 \rightarrow -4R_1 + R_2 \\ R_3 \rightarrow -6R_1 + R_3}} \left(\begin{array}{ccc|c} 1 & 1 & -1 & 0 \\ 0 & -5 & 9 & 0 \\ 0 & -5 & 9 & 0 \end{array}\right) \xrightarrow{R_2 \rightarrow -\frac{1}{5}R_2} \left(\begin{array}{ccc|c} 1 & 1 & -1 & 0 \\ 0 & 1 & -9/5 & 0 \\ 0 & 0 & 0 & 0 \end{array}\right)$. Let x_3 be arbitrary. Use back substitution to find the solutions $(-\frac{4}{5}x_3, \frac{9}{5}x_3, x_3)$.

10. $\left(\begin{array}{ccc|c} 0 & 2 & 5 & 6 \\ 1 & 0 & -2 & 4 \\ 2 & 4 & 0 & -2 \end{array}\right) \xrightarrow{\substack{R_1 \leftrightarrow R_2 \\ R_3 \rightarrow -2R_1 + R_3}} \left(\begin{array}{ccc|c} 1 & 0 & -2 & 4 \\ 0 & 2 & 5 & 6 \\ 0 & 4 & 4 & -10 \end{array}\right) \xrightarrow{\substack{R_2 \rightarrow \frac{1}{2}R_2 \\ R_3 \rightarrow -4R_2 + R_3}} \left(\begin{array}{ccc|c} 1 & 0 & -2 & 4 \\ 0 & 1 & 5/2 & 3 \\ 0 & 0 & -6 & -22 \end{array}\right) \xrightarrow{R_3 \rightarrow -\frac{1}{6}R_3} \left(\begin{array}{ccc|c} 1 & 0 & -2 & 4 \\ 0 & 1 & 5/2 & 3 \\ 0 & 0 & 1 & 11/3 \end{array}\right) \xrightarrow{\substack{R_1 \rightarrow 2R_3 + R_1 \\ R_2 \rightarrow -2.5R_3 + R_2}} \left(\begin{array}{ccc|c} 1 & 0 & 0 & 34/3 \\ 0 & 1 & 0 & -37/6 \\ 0 & 0 & 1 & 11/3 \end{array}\right)$. $(34/3, -37/6, 11/3)$ is the unique solution.

11. $\left(\begin{array}{ccc|c} 1 & 2 & -1 & 4 \\ 3 & 4 & -2 & 7 \end{array}\right) \xrightarrow{\substack{R_2 \rightarrow -3R_1 + R_2 \\ R_2 \rightarrow -\frac{1}{2}R_2}} \left(\begin{array}{ccc|c} 1 & 2 & -1 & 4 \\ 0 & 1 & -1/2 & 5/2 \end{array}\right) \xrightarrow{R_1 \rightarrow -2R_2 + R_1} \left(\begin{array}{ccc|c} 1 & 0 & 0 & -1 \\ 0 & 1 & -1/2 & 5/5/2 \end{array}\right)$. Let x_3 be arbitrary. Then $(-1, \frac{5}{2} + \frac{1}{2}x_3, x_3)$ are the solutions.

12. $\left(\begin{array}{ccc|c} 1 & 2 & -4 & 4 \\ -2 & -4 & 8 & -8 \end{array}\right) \xrightarrow{R_2 \rightarrow 2R_1 + R_2} \left(\begin{array}{ccc|c} 1 & 2 & -4 & 4 \\ 0 & 0 & 0 & 0 \end{array}\right)$. Let x_2 and x_3 be arbitrary. Then $(4 - 2x_2 + 4x_3, x_2, x_3)$ are the solutions.

13. $\left(\begin{array}{ccc|c} 1 & 2 & -4 & 4 \\ -2 & -4 & 8 & -9 \end{array}\right) \xrightarrow{R_2 \rightarrow 2R_1 + R_2} \left(\begin{array}{ccc|c} 1 & 2 & -4 & 4 \\ 0 & 0 & 0 & -1 \end{array}\right)$. Since $0 \neq -1$, the system has no solution.

14. $\left(\begin{array}{cccc|c} 1 & 2 & -1 & 1 & 7 \\ 3 & 6 & -3 & 3 & 21 \end{array}\right) \xrightarrow{R_2 \rightarrow -3R_1 + R_2} \left(\begin{array}{cccc|c} 1 & 2 & -1 & 1 & 7 \\ 0 & 0 & 0 & 0 & 0 \end{array}\right)$. Let $x_2, x_3,$ and x_4 be arbitrary. Then $(7 - 2x_2 + x_3 - x_4, x_2, x_3, x_4)$ are the solutions.

$$15. \left(\begin{array}{cccc|c} 2 & 6 & -4 & 2 & 4 \\ 1 & 0 & -1 & 1 & 5 \\ -3 & 2 & -2 & 0 & -2 \end{array} \right) \xrightarrow{\begin{array}{l} R_1 \rightarrow \frac{1}{2}R_1 \\ R_2 \rightarrow -R_1 + R_2 \\ R_3 \rightarrow 3R_1 + R_2 \end{array}} \left(\begin{array}{cccc|c} 1 & 3 & -2 & 1 & 2 \\ 0 & -3 & 1 & 0 & 3 \\ 0 & 11 & -8 & 3 & 4 \end{array} \right) \xrightarrow{\begin{array}{l} R_2 \rightarrow -\frac{1}{3}R_2 \\ R_1 \rightarrow -3R_2 + R_1 \\ R_3 \rightarrow -11R_2 + R_3 \end{array}} \left(\begin{array}{cccc|c} 1 & 0 & -1 & 1 & 5 \\ 0 & 1 & -1/3 & 0 & -1 \\ 0 & 0 & -13/3 & 3 & 15 \end{array} \right)$$

$$\xrightarrow{\begin{array}{l} R_3 \rightarrow -\frac{3}{13}R_3 \\ R_2 \rightarrow \frac{1}{3}R_3 + R_2 \\ R_1 \rightarrow R_3 + R_1 \end{array}} \left(\begin{array}{cccc|c} 1 & 0 & 0 & 4/13 & 20/13 \\ 0 & 1 & 0 & -3/13 & -28/13 \\ 0 & 0 & 1 & -9/13 & -45/13 \end{array} \right). \text{ Then } \left(\frac{20}{13} - \frac{4}{13}x_4, -\frac{28}{13} + \frac{3}{13}x_4, -\frac{45}{13} + \frac{9}{13}x_4, x_4 \right) \text{ are the}$$

solutions, where x_4 is arbitrary.

$$16. \left(\begin{array}{cccc|c} 1 & -2 & 1 & 1 & 2 \\ 3 & 0 & 2 & -2 & -8 \\ 0 & 4 & -1 & -1 & 1 \\ -1 & 6 & -2 & 0 & 7 \end{array} \right) \xrightarrow{\begin{array}{l} R_2 \rightarrow -3R_1 + R_2 \\ R_4 \rightarrow R_1 + R_4 \end{array}} \left(\begin{array}{cccc|c} 1 & -2 & 1 & 1 & 2 \\ 0 & 6 & -1 & -5 & -14 \\ 0 & 4 & -1 & -1 & 1 \\ 0 & 4 & -1 & 1 & 9 \end{array} \right) \xrightarrow{\begin{array}{l} R_2 \leftrightarrow R_3 \\ R_2 \rightarrow \frac{1}{4}R_2 \end{array}} \left(\begin{array}{cccc|c} 1 & -2 & 1 & 1 & 2 \\ 0 & 1 & -0.25 & -0.25 & 0.25 \\ 0 & 6 & -1 & -5 & -14 \\ 0 & 4 & -1 & 1 & 9 \end{array} \right)$$

$$\xrightarrow{\begin{array}{l} R_3 \rightarrow -6R_2 + R_3 \\ R_4 \rightarrow -4R_2 + R_4 \end{array}} \left(\begin{array}{cccc|c} 1 & -2 & 1 & 1 & 2 \\ 0 & 1 & -0.25 & -0.25 & 0.25 \\ 0 & 0 & 0.5 & -3.5 & -15.5 \\ 0 & 0 & 0 & 2 & 8 \end{array} \right) \xrightarrow{\begin{array}{l} R_3 \rightarrow 2R_3 \\ R_4 \rightarrow \frac{1}{2}R_4 \end{array}} \left(\begin{array}{cccc|c} 1 & -2 & 1 & 1 & 2 \\ 0 & 1 & -0.25 & -0.25 & 0.25 \\ 0 & 0 & 1 & -7 & -31 \\ 0 & 0 & 0 & 1 & 4 \end{array} \right). \text{ Use back sub-}$$

stitution to find the solution $(2, 1/2, -3, 4)$.

$$17. \left(\begin{array}{cccc|c} 1 & -2 & 1 & 1 & 2 \\ 3 & 0 & 2 & -2 & -8 \\ 0 & 4 & -1 & -1 & 1 \\ 5 & 0 & 3 & -1 & -3 \end{array} \right) \xrightarrow{\begin{array}{l} \text{As in} \\ \text{problem 16} \end{array}} \left(\begin{array}{cccc|c} 1 & -2 & 1 & 1 & 2 \\ 0 & 1 & -0.25 & -0.25 & 0.25 \\ 0 & 6 & -1 & -5 & -14 \\ 0 & 10 & -2 & -6 & -13 \end{array} \right) \xrightarrow{\begin{array}{l} R_3 \rightarrow -6R_2 + R_3 \\ R_4 \rightarrow -10R_2 + R_4 \end{array}}$$

$$\left(\begin{array}{cccc|c} 1 & -2 & 1 & 1 & 2 \\ 0 & 1 & -0.25 & -0.25 & 0.25 \\ 0 & 0 & 0.5 & -3.5 & -15.5 \\ 0 & 0 & 0.5 & -3.5 & -15.5 \end{array} \right) \xrightarrow{\begin{array}{l} R_4 \rightarrow -R_3 + R_4 \\ R_3 \rightarrow 2R_3 \end{array}} \left(\begin{array}{cccc|c} 1 & -2 & 1 & 1 & 2 \\ 0 & 1 & -0.25 & -0.25 & 0.25 \\ 0 & 0 & 1 & -7 & -31 \\ 0 & 0 & 0 & 0 & 0 \end{array} \right). \text{ Let } x_4 \text{ be arbitrary. Use}$$

back substitution to find the solutions $(18 - 4x_4, -15/2 + 2x_4, -31 + 7x_4, x_4)$.

$$18. \left(\begin{array}{cccc|c} 1 & -2 & 1 & 1 & 2 \\ 3 & 0 & 2 & -2 & -8 \\ 0 & 4 & -1 & -1 & 1 \\ 5 & 0 & 3 & -1 & 0 \end{array} \right) \xrightarrow{\begin{array}{l} \text{As in} \\ \text{problem 17} \end{array}} \left(\begin{array}{cccc|c} 1 & -2 & 1 & 1 & 2 \\ 0 & 1 & -0.25 & -0.25 & 0.25 \\ 0 & 0 & 0.5 & -3.5 & -15.5 \\ 0 & 0 & 0 & 0 & 3 \end{array} \right). \text{ (Just apply the row operations}$$

above to the changed last column). Since $0 \neq 3$, the system has no solution.

$$19. \left(\begin{array}{cc|c} 1 & 1 & 4 \\ 2 & -3 & 7 \\ 3 & 2 & 8 \end{array} \right) \xrightarrow{\begin{array}{l} R_2 \rightarrow -2R_1 + R_2 \\ R_3 \rightarrow -3R_1 + R_3 \end{array}} \left(\begin{array}{cc|c} 1 & 1 & 4 \\ 0 & -5 & -1 \\ 0 & -1 & -4 \end{array} \right) \xrightarrow{\begin{array}{l} R_2 \leftrightarrow R_3 \\ R_2 \rightarrow -R_2 \\ R_3 \rightarrow 5R_2 + R_3 \end{array}} \left(\begin{array}{cc|c} 1 & 1 & 4 \\ 0 & 1 & 4 \\ 0 & 0 & 19 \end{array} \right). \text{ Since } 0 \neq 19, \text{ the system}$$

has no solution.

$$20. \left(\begin{array}{cc|c} 1 & 1 & 4 \\ 2 & -3 & 7 \\ 3 & -2 & 11 \end{array} \right) \xrightarrow{\begin{array}{l} \text{As in} \\ \text{problem 19} \end{array}} \left(\begin{array}{cc|c} 1 & 1 & 4 \\ 0 & -5 & -1 \\ 0 & -5 & -1 \end{array} \right) \xrightarrow{\begin{array}{l} R_3 \rightarrow -R_2 + R_3 \\ R_2 \rightarrow -\frac{1}{5}R_2 \end{array}} \left(\begin{array}{cc|c} 1 & 1 & 4 \\ 0 & 1 & 0.2 \\ 0 & 0 & 0 \end{array} \right). \text{ Use back substitution to}$$

find the solution $(19/5, 1/5)$.

21. row echelon form 22. neither as the first nonzero in row 1 is not a 1.

23. reduced row echelon form

24. reduced row echelon form

25. neither as the first nonzero in row 2 is too far left.

26. reduced row echelon form

27. reduced row echelon form

28. neither as zero row 2 is not at "bottom".

29. neither as first nonzero in row 3 is too far left.

30. $\begin{pmatrix} 1 & 1 \\ 0 & 1 \end{pmatrix} \rightarrow \begin{pmatrix} 1 & 1.5 \\ 0 & 1 \end{pmatrix}$ row echelon form $\rightarrow \begin{pmatrix} 1 & 0 \\ 0 & 1 \end{pmatrix}$ reduced row echelon form

31. $\begin{pmatrix} -1 & 6 \\ 4 & 2 \end{pmatrix} \rightarrow \begin{pmatrix} 1 & -6 \\ 0 & 1 \end{pmatrix}$ row echelon form $\rightarrow \begin{pmatrix} 1 & 0 \\ 0 & 1 \end{pmatrix}$ reduced row echelon form

32. $\begin{pmatrix} 1 & -1 & 1 \\ 2 & 4 & 3 \\ 5 & 6 & -2 \end{pmatrix} \rightarrow \begin{pmatrix} 1 & -1 & 1 \\ 0 & 6 & 1 \\ 0 & 11 & -7 \end{pmatrix} \rightarrow \begin{pmatrix} 1 & -1 & 1 \\ 0 & 1 & 1/6 \\ 0 & 0 & 1 \end{pmatrix}$ row echelon form
 $\rightarrow \begin{pmatrix} 1 & 0 & 0 \\ 0 & 1 & 0 \\ 0 & 0 & 1 \end{pmatrix}$ reduced row echelon form

33. $\begin{pmatrix} 2 & -4 & 8 \\ 3 & 5 & 8 \\ -6 & 0 & 4 \end{pmatrix} \rightarrow \begin{pmatrix} 1 & -2 & 4 \\ 0 & 11 & -4 \\ 0 & -12 & 28 \end{pmatrix} \rightarrow \begin{pmatrix} 1 & -2 & 4 \\ 0 & 1 & -4/11 \\ 0 & 3 & -7 \end{pmatrix} \rightarrow \begin{pmatrix} 1 & -2 & 4 \\ 0 & 1 & -4/11 \\ 0 & 0 & 1 \end{pmatrix}$ row echelon form
 $\rightarrow \begin{pmatrix} 1 & 0 & 0 \\ 0 & 1 & 0 \\ 0 & 0 & 1 \end{pmatrix}$ reduced row echelon form

34. $\begin{pmatrix} 2 & -4 & -2 \\ 3 & 1 & 6 \end{pmatrix} \rightarrow \begin{pmatrix} 1 & -2 & -1 \\ 0 & 7 & 9 \end{pmatrix} \rightarrow \begin{pmatrix} 1 & -2 & -1 \\ 0 & 1 & 9/7 \end{pmatrix}$ row echelon form
 $\rightarrow \begin{pmatrix} 1 & 0 & 11/7 \\ 0 & 1 & 9/7 \end{pmatrix}$ reduced row echelon form

$$35. \begin{pmatrix} 2 & -7 \\ 3 & 5 \\ 4 & -3 \end{pmatrix} \rightarrow \begin{pmatrix} 1 & -7/2 \\ 0 & 31/2 \\ 0 & 11 \end{pmatrix} \rightarrow \begin{pmatrix} 1 & -7/2 \\ 0 & 1 \\ 0 & 0 \end{pmatrix} \text{ row echelon form}$$

$$\rightarrow \begin{pmatrix} 1 & 0 \\ 0 & 1 \\ 0 & 0 \end{pmatrix} \text{ reduced row echelon form}$$

36. We have $n = 3$, $1 - a_{11} = \frac{2}{3}$, $1 - a_{22} = \frac{3}{4}$, and $1 - a_{33} = \frac{5}{6}$. Then the system is

$$\begin{aligned} \frac{2}{3}x_1 - \frac{1}{2}x_2 - \frac{1}{6}x_3 &= 10 \\ -\frac{1}{4}x_1 + \frac{3}{4}x_2 - \frac{1}{8}x_3 &= 15 \\ -\frac{1}{12}x_1 - \frac{1}{3}x_2 + \frac{5}{6}x_3 &= 30 \end{aligned}$$

Using row reduction, we obtain

$$\left(\begin{array}{ccc|c} 2/3 & -1/2 & -1/6 & 10 \\ -1/4 & 3/4 & -1/8 & 15 \\ -1/12 & -1/3 & 5/6 & 30 \end{array} \right) \rightarrow \left(\begin{array}{ccc|c} 4 & -3 & -1 & 60 \\ -2 & 6 & -1 & 120 \\ 1 & 4 & -10 & -360 \end{array} \right) \rightarrow \left(\begin{array}{ccc|c} 1 & 4 & -10 & -360 \\ 0 & 14 & -21 & -600 \\ 0 & -19 & 39 & 1500 \end{array} \right) \rightarrow$$

$$\left(\begin{array}{ccc|c} 1 & 0 & -4 & -1320/7 \\ 0 & 1 & -3/2 & -300/7 \\ 0 & 0 & 21/2 & 4800/7 \end{array} \right) \rightarrow \left(\begin{array}{ccc|c} 1 & 0 & 0 & 3560/49 \\ 0 & 1 & 0 & 2700/49 \\ 0 & 0 & 1 & 3200/49 \end{array} \right).$$

Hence, the outputs needed for supply to equal demand are $x_1 = 3560/49$, $x_2 = 2700/49$, and $x_3 = 3200/49$.

37. As in example 10, we have the following system:

$$x_1 + 3x_2 + 2x_3 = 15,000$$

$$x_1 + 4x_2 + x_3 = 10,000$$

$$2x_1 + 5x_2 + 5x_3 = 35,000.$$

Writing an augmented matrix for the system and finding the reduced echelon form, we obtain

$$\left(\begin{array}{ccc|c} 1 & 3 & 2 & 15000 \\ 1 & 4 & 1 & 10000 \\ 2 & 5 & 5 & 35000 \end{array} \right) \rightarrow \left(\begin{array}{ccc|c} 1 & 3 & 2 & 15000 \\ 0 & 1 & -1 & -5000 \\ 0 & -1 & 1 & 5000 \end{array} \right) \rightarrow \left(\begin{array}{ccc|c} 1 & 0 & 5 & 30000 \\ 0 & 1 & -1 & -5000 \\ 0 & 0 & 0 & 0 \end{array} \right).$$

Since x_1 , x_2 , and x_3 must be greater than or equal to zero, we must have $x_1 = -5x_3 + 30,000 \geq 0$ and $x_2 = x_3 - 5000 \geq 0$. Hence, the populations that can be supported are $5,000 \leq x_3 \leq 6,000$, $x_1 = 30,000 - 5x_3$, and $x_2 = -5,000 + x_3$. The solution is not unique.

38. Let d_E , d_F , and d_S denote the number of days spent in the respective countries. The information gives the following system of equations:

$$30d_E + 20d_F + 20d_S = 340$$

$$20d_E + 30d_F + 20d_S = 320$$

$$10d_E + 10d_F + 10d_S = 140$$

Upon reducing, we obtain

$$\left(\begin{array}{ccc|c} 30 & 20 & 20 & 340 \\ 20 & 30 & 20 & 320 \\ 10 & 10 & 10 & 140 \end{array} \right) \rightarrow \left(\begin{array}{ccc|c} 1 & 1 & 1 & 14 \\ 2 & 3 & 2 & 32 \\ 3 & 2 & 2 & 34 \end{array} \right) \rightarrow \left(\begin{array}{ccc|c} 1 & 1 & 1 & 14 \\ 0 & 1 & 0 & 4 \\ 0 & -1 & -1 & -8 \end{array} \right) \rightarrow \left(\begin{array}{ccc|c} 1 & 0 & 1 & 10 \\ 0 & 1 & 0 & 4 \\ 0 & 0 & -1 & -4 \end{array} \right) \rightarrow \left(\begin{array}{ccc|c} 1 & 0 & 0 & 6 \\ 0 & 1 & 0 & 4 \\ 0 & 0 & 1 & 4 \end{array} \right).$$

Hence, $d_E = 6$, $d_F = 4$, and $d_S = 4$.

39. Let s_D , s_H , and s_M denote the respective number of shares. The information gives the following system of equations:

$$-s_D - 1.5s_H + 0.5s_M = -350$$

$$1.5s_D - 0.5s_H + s_M = 600$$

Writing the system as an augmented matrix and reducing to echelon form gives

$$\left(\begin{array}{ccc|c} -1 & -1.5 & 0.5 & -350 \\ 1.5 & -0.5 & 1 & 600 \end{array} \right) \rightarrow \left(\begin{array}{ccc|c} 1 & 1.5 & -0.5 & 350 \\ 0 & -2.75 & 1.75 & 75 \end{array} \right) \rightarrow \left(\begin{array}{ccc|c} 1 & 0 & 0.4545 & 390.9 \\ 0 & 1 & -0.6364 & -27.27 \end{array} \right).$$

Since s_M can be chosen arbitrarily, the broker does not have enough information. If $s_M = 200$, then $s_E = 300$ and $s_H = 100$.

40. Let f and b denote the number of fighter planes and bombers, respectively. The information gives the following equations:

$$f + b = 60$$

$$6f + 2b = 250$$

$$f - 2b = 0$$

Then $\left(\begin{array}{cc|c} 1 & 1 & 60 \\ 6 & 2 & 250 \\ 1 & -2 & 0 \end{array} \right) \rightarrow \left(\begin{array}{cc|c} 1 & 1 & 60 \\ 0 & -4 & -110 \\ 0 & -3 & -60 \end{array} \right) \rightarrow \left(\begin{array}{cc|c} 1 & 1 & 60 \\ 0 & 1 & 20 \\ 0 & -4 & -110 \end{array} \right) \rightarrow \left(\begin{array}{cc|c} 1 & 1 & 60 \\ 0 & 1 & 20 \\ 0 & 0 & -30 \end{array} \right)$. Since $0 \neq -30$, the system is inconsistent.

41. $\left(\begin{array}{ccc|c} 2 & -1 & 3 & a \\ 3 & 1 & -5 & b \\ -5 & -5 & 21 & c \end{array} \right) \rightarrow \left(\begin{array}{ccc|c} 1 & 2 & -8 & b-a \\ 2 & -1 & 3 & a \\ -5 & -5 & 21 & c \end{array} \right) \rightarrow \left(\begin{array}{ccc|c} 1 & 2 & -8 & b-a \\ 0 & -5 & 19 & -2b+3a \\ 0 & 5 & -19 & 5b-5a+c \end{array} \right) \xrightarrow{R_3 \rightarrow R_3 + R_2} \left(\begin{array}{ccc|c} 1 & 2 & -8 & b-a \\ 0 & -5 & 19 & -2b+3a \\ 0 & 0 & 0 & 3b-2a+c \end{array} \right)$.

Hence, the system is inconsistent if $3b - 2a + c \neq 0$.

42. $\left(\begin{array}{ccc|c} 2 & 3 & -1 & a \\ 1 & -1 & 3 & b \\ 3 & 7 & -5 & c \end{array} \right) \rightarrow \left(\begin{array}{ccc|c} 1 & -1 & 3 & b \\ 0 & 5 & -7 & a-2b \\ 0 & 10 & -14 & c-3b \end{array} \right) \xrightarrow{R_3 \rightarrow R_3 - 2R_2} \left(\begin{array}{ccc|c} 1 & -1 & 3 & b \\ 0 & 5 & -7 & a-2b \\ 0 & 0 & 0 & -2a+b+c \end{array} \right)$. For the system to

be consistent, we must have $-2a + b + c = 0$.

43. Either a_{11} , a_{21} , or a_{31} is nonzero, otherwise, the system is either inconsistent or has an infinite number of solutions. Without loss of generality, we may assume $a_{11} \neq 0$. Elementary row operations give $\left(\begin{array}{ccc|c} a_{11} & a_{12} & a_{13} & b_1 \\ a_{21} & a_{22} & a_{23} & b_2 \\ a_{31} & a_{32} & a_{33} & b_3 \end{array}\right) \rightarrow \left(\begin{array}{ccc|c} 1 & a_{12}/a_{11} & a_{13}/a_{11} & * \\ 0 & \alpha_{22} & \alpha_{23} & * \\ 0 & \alpha_{32} & \alpha_{33} & * \end{array}\right)$ where $\alpha_{22} = a_{22} - a_{21}a_{12}/a_{11}$, $\alpha_{23} = a_{23} - a_{21}a_{13}/a_{11}$, $\alpha_{32} = a_{32} - a_{31}a_{12}/a_{11}$, and $\alpha_{33} = a_{33} - a_{31}a_{13}/a_{11}$. As before, either α_{22} or α_{32} is nonzero. Assume $\alpha_{22} \neq 0$. Then $\left(\begin{array}{ccc|c} 1 & * & * & * \\ 0 & \alpha_{22} & \alpha_{23} & * \\ 0 & \alpha_{32} & \alpha_{33} & * \end{array}\right) \rightarrow \left(\begin{array}{ccc|c} 1 & * & * & * \\ 0 & 1 & * & * \\ 0 & 0 & \beta & * \end{array}\right)$. Where $\beta = \alpha_{32}\alpha_{23}/\alpha_{22} + \alpha_{33}$. For the system to have a unique solution, we must have $\beta \neq 0$. Simplify β to conclude $a_{11}a_{22}a_{33} - a_{11}a_{23}a_{32} - a_{12}a_{21}a_{33} + a_{12}a_{23}a_{31} + a_{13}a_{21}a_{32} - a_{13}a_{22}a_{31} \neq 0$.

CALCULATOR SOLUTIONS 1.3

All solutions to **CALCULATOR BOX** problems will be given for the TI-85. Each will include a summary of the input keystrokes which were used to solve each type of problem, the output from the calculator, and the derivation of the answer from the output. Usually the fullest explanation will accompany the first example of each type of problem.

Most problems will require calculations to be made on some matrix or vector. Each such input for a problem should be entered into a variable before the calculations for that problem are begun. Once it is input, its' value should be checked before the calculation for the problem is begun, since one of the most frequent causes of incorrect solutions is faulty input data. (We will not show the data input keystrokes in most cases, except in this first calculator solution section.) In order to allow the inputs (or outputs) for any problem to be reused or recalled in later problems, we shall tag the variable name(s) with numbers representing the chapter, section, and problem number; i.e. A1345 will be the name for the augmented matrix which is the input for chapter 1, section 3, problem 45.

Each summary of input keystrokes follows the practice of the main text by boxing each input function keystroke (except for character or number keys which are displayed in the *Courier* font, and for which it is assumed that the appropriate **ALPHA** or **2nd alpha** keystrokes have been entered to allow alphabetic input to start or stop). When a keystroke sequence has selected a **menu item**, the named equivalent of that item will be displayed in **Courier Bold** inside angle brackets. For example the keystrokes to compute the reduced row echelon form of a matrix stored in the variable A1345 are displayed as:

2nd **MATRX** **F4** <ops> **F5** <rref> A1345 **ENTER** .

We will use the form **MATRX ops rref** to abbreviate later occurrences of such a menu item entry.

There is an alternative to all menu item function references. Since the name of any function, such as *rref*, is recognized by the TI-85 (even the all caps version *RREF*), the result above can be produced by the (character) input *rref* A1345 **ENTER** or even *RREF* A1345 **ENTER** . We will often use this form of input in presenting solutions.

44. To solve on the TI-85 enter the augmented matrix for the system by [[2.6, -4.3, 9.6, 21.62] [-8.5, 3.6, 9.1, 14.23] [12.3, -8.4, -6, 12.61]] **STO>** A1344 **ENTER**

Then compute the reduced row echelon form of A1344 by using the **RREF** command from the **MATRX ops** menu via **2nd** **MATRX** **F4** <ops> **F5** <**RREF**> **ALPHA** A1344 **ENTER** ,

to produce:

```
[ [ 1 0 0 86.1806588556 ]
  [ 0 1 0 122.285821022 ]
  [ 0 0 1 33.6853455595 ] ]
```

which is the augmented matrix of the equivalent (solved) system:

$$x_1 = 86.1806588556, x_2 = 122.285821022, x_3 = 33.6853455595.$$

45. To solve, input the augmented matrix A1345 by [[0, 2, -1, -4, 2], [1, -1, 5, 2, -4], [3, 3, -7, -1, 4], [-1, -2, 3, 0, -7]] **STO>** A1345 **ENTER** , and verify that the matrix has been correctly entered by scrolling the display to examine all the entries of the input matrix. (Use the arrow keys: **▶** , **◀** , and **▼** , **▲** if needed.) Note that the "missing" x_1 in the first equation is entered as a 0 in the first row.

Now either use the **MATRX ops** menu, as described above, or literally enter *RREF* A1345 (which requires the keystrokes **ALPHA** **ALPHA** *RREF* A **ALPHA** 1345 **ENTER**) to get:

$$\begin{bmatrix} 1 & 0 & 0 & 0 & -3 \\ 0 & 1 & 0 & 0 & 5 \\ 0 & 0 & 1 & 0 & 2E-14 \\ 0 & 0 & 0 & 1 & 2 \end{bmatrix}$$

Since elementary row operations produce an augmented matrix of an equivalent system, the solutions to the original system can be read off from this equivalent (solved) system:

$$x_1 = -3, \quad x_2 = 5, \quad x_3 = 2E-14, \quad x_4 = 2.$$

(The calculator produced $2E-14$, rather than the exact answer 0, due to rounding "errors" in its computation; its accuracy is limited (internally) to 13 significant figures, and many computations, like division by 3, may result in loss of accuracy due to roundoff.)

46. Input the augmented matrix A1346: $[[12.47, -2.583, 7.161, 8.275, -1.205], [3.472, 9.283, 11.275, 3.606, 2.374], [-5.216, -12.816, 6.298, 1.877, 21.206], [6.812, 5.223, -9.725, -2.306, -11.466]]$ $\boxed{\text{STO}} \text{ A1346}$ and compute its reduced row echelon form R1346 by entering $\text{RREF A1346} \boxed{\text{STO}} \text{ R1346} \boxed{\text{ENTER}}$. Since we see the equations are consistent, the solutions are obtained from the last (5th) column: (see problem 47) $\text{R1346}(1, 5, 4, 5) \boxed{\text{ENTER}}$,

$$\begin{bmatrix} 2.22665461875 \\ -1.93595628754 \\ 3.36239929557 \\ -7.01511776944 \end{bmatrix} \begin{matrix} (= x_1) \\ (= x_2) \\ (= x_3) \\ (= x_4) \end{matrix}$$

47. Input the augmented matrix by $[[23.42, -16.89, 57.31, 82.6, 2158.36], [-14.77, 38.29, 92.36, -4.36, -1123.02], [-77.21, 71.26, -16.55, 43.09, 3248.71], [91.82, 81.43, 33.94, -57.22, 235.25]]$ $\boxed{\text{ENTER}}$, and store it in A1347 by entering:

$$\boxed{2\text{nd}} \boxed{\text{ANS}} \boxed{\text{STO}} \text{ A1347} \boxed{\text{ENTER}}.$$

Then either follow the 1.44 or 1.45 solutions or produce and store the reduced echelon form in R1347 ("R" for reduced) via:

$$\text{RREF A1347} \boxed{\text{STO}} \text{ R1347}$$

The reduced echelon form shows the equations are consistent, and the solution is the last (5th) column of R1347 which can be printed out by entering $\text{R1347}(1, 5, 4, 5) \boxed{\text{ENTER}}$, which yields the submatrix starting at (row=1,col=5) and ending at (row=4,col=5):

$$\begin{bmatrix} 11.5606292935 \\ 27.8933709005 \\ -19.8752502433 \\ 42.3460010642 \end{bmatrix} \begin{matrix} (= x_1) \\ (= x_2) \\ (= x_3) \\ (= x_4) \end{matrix}$$

48. From the input:

$$[[6.1, -2.4, 23.3, -16.4, -8.9, 121.7] [-14.2, -31.6, -5.8, 9.6, 23.1, -87.7]$$

$$[10.5, 46.1, -19.6, -8.8, -41.2, 10.8] [37.3, -14.2, 62, 14.7, -9.6, 61.3]$$

$[.8, 17.7, -47.5, -50.2, 29.8, -27.8]] \boxed{\text{STO}} \text{ A1348} \boxed{\text{ENTER}}$ compute and store the reduced echelon form by $\text{RREF A1348} \boxed{\text{STO}} \text{ O1348} \boxed{\text{ENTER}}$. From the equivalent (consistent) system corresponding to this new augmented matrix, read off solution from the last (6th) column: $\text{O1348}(1, 6, 5, 6) \boxed{\text{ENTER}}$

$$\begin{bmatrix} -4.19625216237 &] & (=x_1) \\ 3.39806581665 &] & (=x_2) \\ 5.02950855373 &] & (=x_3) \\ -2.68699108976 &] & (=x_4) \\ .651877193675 &] & (=x_5) \end{bmatrix}$$

Problems 49-53 ask for the **row echelon form** of the augmented matrices from the equations in the previous 5 problems. This will be computed by:

2nd **MATRIX** **F4** <ops> **F4** <ref> A **ENTER**

or using only alphabetic and numeric input:

REF A **ENTER** .

49. The row echelon form for A1345 (saved in 1.45) is given by REF A1345 **ENTER** :

$$\begin{bmatrix} 1 & 1 & -2.33333333333 & -.33333333333 & 1.33333333333 &] \\ 0 & 1 & -.5 & -2 & 1 &] \\ 0 & 0 & 1 & -.263157894737 & -.526315789474 &] \\ 0 & 0 & 0 & 1 & 2 &] \end{bmatrix}$$

50. The requested row echelon form is given by REF A1344 **ENTER** :

$$\begin{bmatrix} 1 & -.682926829268 & -.048780487805 & 1.02520325203 &] \\ 0 & 1 & -3.85314009662 & -7.50853462158 &] \\ 0 & 0 & 1 & 33.6853455595 &] \end{bmatrix}$$

51. REF A1347 **ENTER** yields:

$$\begin{bmatrix} 1 & .886843824875 & .369636244827 & -.623175778697 & 2.56207797865 &] \\ 0 & 1 & .085803613297 & -.035964262264 & 24.6650599263 &] \\ 0 & 0 & 1 & -.125426892275 & -25.1865775571 &] \\ 0 & 0 & 0 & 1 & 42.3460010642 &] \end{bmatrix}$$

52. REF A1346 **ENTER** yields:

$$\begin{bmatrix} 1 & -.20713712911 & .574258219727 & .663592622294 & -.096631916599 &] \\ 0 & 1 & -.668756846388 & -.384149034562 & -1.48973311827 &] \\ 0 & 0 & 1 & .322120802509 & 1.10268392998 &] \\ 0 & 0 & 0 & 1 & -7.01511776944 &] \end{bmatrix}$$

53. REF A1348 **ENTER** yields:

```
[ [ 1 -.380697050938 1.66219839142 .394101876676 -.257372654156 1.64343163539 ]
[ 0 1 -.739622076066 -.258258724306 -.768456034635 -.128869813714 ]
[ 0 0 1 1.29150456157 -1.23451620607 .754494344443 ]
[ 0 0 0 1 -.245789833397 -2.84721587659 ]
[ 0 0 0 0 1 .651877193675 ] ]
```

Problems 54-58 ask for all solutions, rounded to three decimal places, to certain systems with more unknowns than equations. To solve, first set the displayed precision to three decimal places by

`2nd` `MODE` `▼` `▶` `▶` `▶` `▶` `ENTER` `EXIT` .

Then compute the reduced echelon form of the augmented matrix via `RREF A` `ENTER` and write down the equivalent system for the resulting augmented matrix. If there is a new equation which says $0 =$ a non-zero number, then this impossible equation shows the original system is inconsistent, i.e. has no solutions. Other wise, we can see that if we assign arbitrary values to those variables which are **not** first in any of the resulting equations, then each equation can be solved for its first variable in terms of the arbitrary variables by bringing the terms involving the arbitrary variables to the right side of the new equations (after changing the signs of those terms). This gives all possible solutions.

54. The augmented matrix A1354 for the system is obtained by input of `[[2.1, 4.2, -3.5, 12.9] [-5.9, 2.7, 9.8, -1.6]]` `STO▶` A1354 `ENTER` . Then the reduced row echelon form `RREF A1354`:

```
[ [ 1 0 -1.662 1.365 ]
[ 0 1 -.002 2.389 ] ]
```

is the augmented matrix of a consistent system. In this equivalent system, we see that transposing the x_3 terms to the right side yields the solutions $(1.365 + 1.662x_3, 2.389 - .002x_3, x_3)$ with x_3 arbitrary.

55. Input the augmented matrix A1355 for the system with `[[-13.6, 71.8, 46.3, -19.5] [41.3, -75, -82.9, 46.4] [41.8, 65.4, -26.9, 34.3]]` `STO▶` A1355 `ENTER` . Then the reduced row echelon form `RREF A1355`:

```
[ [ 1 0 -1.275 .961 ]
[ 0 1 .403 -.009 ]
[ 0 0 0 0 ] ]
```

is the augmented matrix of the equivalent consistent system:

$$\begin{aligned} x_1 - 1.275x_3 &= .961 \\ x_2 + .403x_3 &= -.009 \end{aligned}$$

From this we see that transposing the x_3 terms to the right side yields the solutions $(.961 + 1.275x_3, -.009 - .403x_3, x_3)$ with x_3 arbitrary.

56. Since this system differs from the previous system only in two right hand side entries

19.5 instead of -19.5 and 35.3 instead of 34.3

the usual input can be omitted and the augmented matrix A1356 can be obtained by copying A1355 and editing the 4'th column of the copy. (The keystrokes to copy and get to the editing stage are: A1355 `STO▶` A1356 `2nd` `MATRX` `F2` `<EDIT>` . Then at the Name= prompt enter A1356 `ENTER` `ENTER` `ENTER` . Now the 4'th column is displayed; use the arrow keys to position the cursor and make the

changes: delete the "-" and change 34 to 35. Then enter **EXIT** and the new augmented matrix $[-13.6, 71.8, 46.3, 19.5] [41.3, -75, -82.9, 46.4] [41.8, 65.4, -26.9, 35.3]$ is stored in A1356.) Then the reduced row echelon form RREF A1356:

$$\begin{bmatrix} 1 & 0 & -1.275 & 0 \\ 0 & 1 & .403 & 0 \\ 0 & 0 & 0 & 1 \end{bmatrix}$$

is the augmented matrix of an *inconsistent* system as the last row yields the equation $0 = 1$. Thus there are no solutions.

57. Input the augmented matrix A1357 for the system with: $[[5, -2, 11, -16, 12, 105] [-6, 8, -14, -9, 26, -62] [7, -18, -12, 21, -2, 53]]$ **STO▶** A1357 **ENTER**. Then the reduced row echelon form RREF A1357:

$$\begin{bmatrix} 1 & 0 & 0 & -7.616 & 11.87 & 31.348 \\ 0 & 1 & 0 & -4.876 & 6.775 & 11.043 \\ 0 & 0 & 1 & 1.121 & -3.072 & -2.696 \end{bmatrix}$$

shows x_4 and x_5 can be chosen arbitrarily. If we bring the terms involving these variables to the right side we get solutions $(31.348+7.616x_4-11.87x_5, 11.043+4.876x_4-6.775x_5, -2.696-1.121x_4+3.072x_5, x_4, x_5)$.

58. (To illustrate an alternative way to reuse data, we present a solution based on the prior entry of A1359. See problem 59 for a way to enter A1359.) Just copy A1359 into A1358 and change the {4,6} element by -63 **STO▶** A1358(4,6). Then RREF A1358 yields:

$$\begin{bmatrix} 1 & 0 & 0 & 0 & 11.87 & 31.348 \\ 0 & 1 & 0 & 0 & 6.775 & 11.043 \\ 0 & 0 & 1 & 0 & -3.072 & -2.696 \\ 0 & 0 & 0 & 1 & 0 & 0 \end{bmatrix}$$

from which we read off the solutions $(31.348-11.87x_5, 11.043-6.775x_5, -2.696+3.072x_5, 0, x_5)$ with x_5 arbitrary.

59. An alternative to the usual input of A1359 is to add a new row to A1357. This is done by A1357 **STO▶** A1359 and then adding a new row (of zeros) by **2nd** **LIST** **<{>4,6<}** **STO▶** **2nd** **MATRIX** **<ops><dim>**A1359. Now use the **MATRIX<EDIT>** function to change the fourth row elements to -15, 42, 21, -17, 42, 63. Then the reduced row echelon form RREF A1359 is

$$\begin{bmatrix} 1 & 0 & 0 & 0 & 11.87 & 50.54 \\ 0 & 1 & 0 & 0 & 6.775 & 23.33 \\ 0 & 0 & 1 & 0 & -3.072 & -5.52 \\ 0 & 0 & 0 & 1 & 0 & 2.52 \end{bmatrix}$$

from which we read off the solutions $(50.54-11.87x_5, 23.33-6.775x_5, -5.52+3.072x_5, 2.52, x_5)$ with x_5 arbitrary.

MATLAB Tutorial

The MATLAB input and output for these problems will be printed in **this typewriter font**. The symbol `>>` is the MATLAB prompt. We will often suppress output by use of `;` although you should always check your input.

1. They can be entered as

```
>> A = [ 2 2 3 4 5; -6 -1 2 0 7; 1 2 -1 3 4], b = [-1; 2; 5];
```

or as

```
>> A = [ 2 2 3 4 5
        -6 -1 2 0 7
         1 2 -1 3 4 ];
>> b = [ -1
         2
         5 ];
```

2. The augmented matrix is:

```
>> C = [ A b]
C =
     2     2     3     4     5    -1
    -6    -1     2     0     7     2
     1     2    -1     3     4     5
```

3. Notice that since this problem uses `rand`, you will get different numbers than those printed here. This generates a random 3×4 matrix with values between -1 and 1, and then multiplies that by 2.

```
>> D = 2*( 2*rand(3,4) - 1 )
D =
   -1.1242    0.7172    0.0777   -1.7862
   -1.8118    1.7388    1.3239    0.1188
    0.7155   -0.4660   -1.8617    0.6846
```

4. This generates a random 4×4 matrix with entries between -10 and 10, and then rounds off to the nearest integer.

```
>> B = round( 10*( 2*rand(4,4) - 1 ) )
B =
   -10     4     1     4
    -2     2    -8     8
    -9     9     3     5
    -2     7    -2    -5
```

5. This first copies B into K , and then reverses the two rows in K .

```
>> K = B; K([ 1 4],:) = K([4 1],:)
K =
    -2     7     -2     -5
    -2     2     -8     8
    -9     9     3     5
   -10     4     1     4
```

3.

```
>> C(3,:) = C(3,:) + (-1/2)*C(1,:)
C =
    2.0000    2.0000    3.0000    4.0000    5.0000   -1.0000
   -6.0000   -1.0000    2.0000         0    7.0000    2.0000
         0    1.0000   -2.5000    1.0000    1.5000    5.5000
```

7.

```
>> B([2 4],[1 3]) % This is the 2x2 submatrix of B
>> % made from the second and fourth rows
>> % and the first and third columns.
ans =
    -2    -8
    -2    -2
```

3. Recall that D from problem 3 was a random matrix, so your values will be different.

```
>> U = D(:,[3 4])
U =
    0.0777   -1.7862
    1.3239    0.1188
   -1.8617    0.6846
```

1.

```
>> C(2,:) = C(2,:) + 3*C(1,:)
C =
    2.0000    2.0000    3.0000    4.0000    5.0000   -1.0000
         0    5.0000   11.0000   12.0000   22.0000   -1.0000
         0    1.0000   -2.5000    1.0000    1.5000    5.5000
```

10. This will generate a random matrix:

```
>> T = rand(8,7)
```

Notice that if you type

```
>> help :      % Use this in matlab version 3.5
```

or

```
>> help colon  % Use this in matlab version 4.0
```

that `3:8` is the same as `[3 4 5 6 7 8]`, so

```
>> S = T( 3:8 ,:)
```

will generate rows 3 through 8 of T .

11. The reduced row echelon form of C will be:

```
>> rref(C)
ans =
    1.0000         0         0   -0.1915   -1.4681   -1.1489
         0    1.0000         0    1.7447    3.0426    2.4681
         0         0    1.0000    0.2979    0.6170   -1.2128
```

So that an equivalent system of equations would be:

$$\begin{aligned} x_1 & -0.1915x_4 - 1.4681x_5 = -1.1489 \\ x_2 & +1.7447x_4 + 3.0426x_5 = 2.4681 \\ x_3 & +0.2979x_4 + 0.6170x_5 = -1.2128 \end{aligned}$$

MATLAB 1.3

- For each problem, first A is entered as the augmented matrix representing the system of equations. Next R is set to be the reduced row-echelon form of A . R represents a system whose solution, x , is just the last column of R . Since in each case, the system reduces to one where no variables may be chosen arbitrarily, there is a unique solution.

For problem 1:

```
>> A = [ 1 -2 3 11; 4 1 -1 4; 2 -1 3 10];
>> R = rref(A)
R =
    1     0     0     2
    0     1     0    -3
    0     0     1     1
>> x = R(:,4)           % Equivalent system says jth variable
x =                    % Equal to the jth entry in the last column.
    2
   -3
    1
```

For problem 2:

```
>> A = [-2 1 6 18; 5 0 8 -16; 3 2 -10 -3];
>> R = rref(A)
R =
    1.0000         0         0   -4.0000
         0    1.0000         0    7.0000
         0         0    1.0000    0.5000
>> x = R(:,4)
x =
   -4.0000
    7.0000
    0.5000
```

For problem 5:

```
>> A = [1 1 -1 7; 4 -1 5 4; 2 2 -3 0];
>> R = rref(A)
R =
    1     0     0    -9
    0     1     0    30
    0     0     1    14
>> x = R(:,4)
x =
   -9
   30
   14
```

For problem 8:

```
>> A = [1 -2 3 0; 4 1 -1 0; 2 -1 3 0];
>> R = rref(A)
R =
    1    0    0    0
    0    1    0    0
    0    0    1    0
>> x = R(:,4)
x =
    0
    0
    0
```

For problem 16:

```
>> A = [1 -2 1 1 2; 3 0 2 -2 -8; 0 4 -1 -1 1; -1 6 -2 0 7];
>> R = rref(A)
R =
    1.0000    0    0    0    2.0000
    0    1.0000    0    0    0.5000
    0    0    1.0000    0   -3.0000
    0    0    0    1.0000    4.0000
>> x = R(:,5)
x =
    2.0000
    0.5000
   -3.0000
    4.0000
```

2. For each problem, first A is entered as the augmented matrix representing the system of equations. Next R is set to be the reduced row-echelon form of A . Since the bottom row of R represents an equation $0 = 1$, there can be no solutions to this system.

For problem 4:

```
>> A = [3 6 -6 9; 2 -5 4 6; 5 28 -26 -8];
>> R = rref(A)
R =
    1.0000    0   -0.2222    0
    0    1.0000   -0.8889    0
    0    0    0    1.0000
```

For problem 7:

```
>> A = [1 1 -1 7; 4 -1 5 4; 6 1 3 20];
>> R = rref(A)
R =
    1.0000    0    0.8000    0
    0    1.0000   -1.8000    0
    0    0    0    1.0000
```

For problem 13:

```
>> A = [ 1 2 -4 4; -2 -4 8 -9];
>> R = rref(A)
R =
    1     2    -4     0
    0     0     0     1
```

For problem 18:

```
>> A = [1 -2 1 1 2; 3 0 2 -2 -8; 0 4 -1 -1 1; 5 0 3 -1 0];
>> R = rref(A)
R =
    1     0     0     4     0
    0     1     0    -2     0
    0     0     1    -7     0
    0     0     0     0     1
```

3. (i) (a) For the matrix we have

```
>> A = [ 3 5 1 0; 4 2 -8 0; 8 3 -18 0];
>> R = rref(A)
R =
    1     0    -3     0
    ---
    0     1     2     0
    ---
    0     0     0     0
```

(b) The pivots have been underlined. (c) An equivalent system of equations would be

$$\begin{aligned} x_1 - 3x_3 &= 0 \\ x_2 + 2x_3 &= 0 \end{aligned}$$

(d) No pivot in column 3, so the solution of this system has: x_3 arbitrary, $x_1 = 3x_3$, $x_2 = -2x_3$.

(ii) (a)

```
>> A = [ 9 27 3 3 12; 9 27 10 1 19; 1 3 5 9 6];
>> R = rref(A)
R =
    1     3     0     0     1
    ---
    0     0     1     0     1
    ---
    0     0     0     1     0
    ---
```

(c) An equivalent system of equations would be

$$\begin{aligned} x_1 + 3x_2 &= 1 \\ x_3 &= 1 \\ x_4 &= 1 \end{aligned}$$

(d) No pivot in column 2 so the solution of this system is: x_2 arbitrary, $x_1 = 1 - 3x_2$, $x_3 = 1$, $x_4 = 0$.

(iii) (a)

```
>> A = [ 1 0 1 -2 7 -4; 1 4 21 -2 2 5; 3 0 3 -6 7 2];
>> R = rref(A)
R =
  1      0      1     -2      0      3
  ---
  0      1      5      0      0      1
  ---
  0      0      0      0      1     -1
  ---
```

(c) An equivalent system of equations would be

$$\begin{aligned} x_1 + x_3 - 2x_4 &= 3 \\ x_2 + 5x_3 &= 1 \\ x_5 &= -1 \end{aligned}$$

(d) No pivots in columns 3 and 4 so the solution of this system is: x_3 and x_4 arbitrary, $x_1 = 3 - x_3 + 2x_4$, $x_2 = 1 - 5x_3$, $x_5 = -1$.

(iv) (a)

```
>> A = [ 6 4 7 5 15 9
         8 5 9 10 10 8
         4 5 7 7 -1 7
         8 3 7 6 22 8
         3 2 7/2 9 -12 -2];
>> R = rref(A)
R =
  1.0000      0  0.5000      0  5.0000  1.0000
  -----
  0  1.0000  1.0000      0      0  2.0000
  -----
  0      0      0  1.0000 -3.0000 -1.0000
  -----
  0      0      0      0      0      0
  0      0      0      0      0      0
```

(c) An equivalent system of equations would be

$$\begin{aligned} x_1 + .5x_3 + 5x_5 &= 1 \\ x_2 + 1x_3 &= 2 \\ x_4 - 3x_5 &= -1 \end{aligned}$$

(d) No pivots in columns 3 and 5 so the solution of this system is: x_3 and x_5 arbitrary, $x_1 = 1 - .5x_3 - 5x_5$, $x_2 = 2 - x_3$, and $x_4 = -1 + 3x_5$.

4. (i) Reduce the augmented matrix representing the equations:

```
>> rref( [ 1 2 3 -1; 0 -3 1 4; 4 1 -2 0] )
ans =
    1.0000         0         0    0.4694
         0    1.0000         0   -1.2245
         0         0    1.0000    0.3265
```

From this, the solution is $x_1 = 0.4694$, $x_2 = -1.2245$ and $x_3 = 0.3265$. Since there is only one solution, these three planes intersect in exactly one point.

(ii) Reduce the matrix as in (i):

```
>> rref( [ 2 -1 4 5; 1 2 -3 6; 4 3 -2 9] )
ans =
     1     0     1     0
     0     1    -2     0
     0     0     0     1
```

There are no solutions, i.e. the system is inconsistent. This means the three planes do not intersect.

(iii)

```
>> rref( [ 2 -1 4 5; 1 2 -3 6; 4 3 -2 17] )
ans =
    1.0000         0    1.0000    3.2000
         0    1.0000   -2.0000    1.4000
         0         0         0         0
```

The solution has x_3 arbitrary, $x_2 = 1.4 + 2x_3$, and $x_1 = 3.2 - x_3$. The planes intersect in a line.

(iv)

```
>> rref( [ 2 -4 2 4; 3 -6 3 6; -1 2 -1 -2] )
ans =
     1    -2     1     2
     0     0     0     0
     0     0     0     0
```

The solution has x_3 and x_2 arbitrary, and $x_1 = 2 + 2x_2 - x_3$. The three planes are identical.

5. (i)

```
>> A = [1 2 -1 2; 2 4 2 8; 3 4 -7 0];
>> D=A;
>> A(2,:) = A(2,:) - 2*A(1,:); % Subtract 2*R1 from R2.
>> A(3,:) = A(3,:) - 3*A(1,:); % Subtract 3*R1 from R3.
```

```
A =
     1     2    -1     2
     0     0     4     4
     0    -2    -4    -6
```

```
>> A([2 3],:) = A([3 2], :) % Interchange R2 and R3.
```

```
A =
     1     2    -1     2
     0    -2    -4    -6
     0     0     4     4
```

```

>> A(2,:) = A(2,:) / (-2);    % Normalize R2.
>> A(1,:) = A(1,:) - 2*A(2,:) % Subtract 2*R2 from R1.

A =
     1     0     -5     -4
     0     1     2     3
     0     0     4     4

>> A(3,:) = A(3,:) / 4;      % Normalize R3
>> A(2,:) = A(2,:) - 2*A(3,:); % Subtract 2*R3 from R2.
>> A(1,:) = A(1,:) + 5*A(3,:); % Subtract -5*R3 from R1.

A =
     1     0     0     1
     0     1     0     1
     0     0     1     1

```

Compare this with:

```

>> rref(D)
ans =
     1     0     0     1
     0     1     0     1
     0     0     1     1

```

(ii)

```

>> A = [1 2 3 2; 3 4 -1 -3; -2 1 0 4];
>> D = A;
>> A(2,:) = A(2,:) - 3*A(1,:); % Subtract 3*R1 from R2.
>> A(3,:) = A(3,:) + 2*A(1,:); % Subtract -2*R1 from R3.

A =
     1     2     3     2
     0    -2    -10    -9
     0     5     6     8

>> A(2,:) = A(2,:) / (-2);    % Normalize R2.
>> A(1,:) = A(1,:) - 2*A(2,:); % Subtract 2*R2 from R1.
>> A(3,:) = A(3,:) - 5*A(2,:); % Subtract 5*R2 from R3.

A =
  1.0000         0   -7.0000   -7.0000
         0  1.0000    5.0000    4.5000
         0         0  -19.0000  -14.5000

>> A(3,:) = A(3,:) / (-19);    % Normalize R3.
>> A(2,:) = A(2,:) - 5*A(3,:); % Subtract 5*R3 from R2.
>> A(1,:) = A(1,:) + 7*A(3,:); % Subtract -7*R3 from R1.

A =
  1.0000         0         0   -1.6579
         0  1.0000         0    0.6842
         0         0    1.0000    0.7632

```

Compare this with:

```
>> rref(D)
ans =
    1.0000         0         0   -1.6579
         0    1.0000         0    0.6842
         0         0    1.0000    0.7632
```

(iii)

```
>> A = [1  2 -2  0  1 -2
        2  4 -1  0 -4 -19
        -3 -6 12  2 -12 -8
         1  2 -2 -4 -5 -34];
```

```
>> D = A;
>> A(2,:) = A(2,:) - 2*A(1,:); % Subtract 2*R1 from R2.
>> A(3,:) = A(3,:) + 3*A(1,:); % Subtract -3*R1 from R3.
>> A(4,:) = A(4,:) - 1*A(1,:); % Subtract R1 from R4.
```

```
A =
     1     2    -2     0     1    -2
     0     0     3     0    -6   -15
     0     0     6     2    -9   -14
     0     0     0    -4    -6   -32
```

```
>> A(2,:) = A(2,:) / (3); % Normalize R2.
>> A(1,:) = A(1,:) + 2*A(2,:); % Subtract -2*R2 from R1.
>> A(3,:) = A(3,:) - 6*A(2,:); % Subtract 6*R2 from R3.
```

```
A =
     1     2     0     0    -3   -12
     0     0     1     0    -2    -5
     0     0     0     2     3    16
     0     0     0    -4    -6   -32
```

```
>> A(3,:) = A(3,:) / (2); % Normalize R3.
>> A(4,:) = A(4,:) + 4*A(3,:); % Subtract -4*R3 from R4.
```

```
A =
    1.0000    2.0000         0         0   -3.0000  -12.0000
         0         0    1.0000         0   -2.0000   -5.0000
         0         0         0    1.0000    1.5000    8.0000
         0         0         0         0         0         0
```

Compare this with:

```
>> rref(D)
ans =
    1.0000    2.0000         0         0   -3.0000  -12.0000
         0         0    1.0000         0   -2.0000   -5.0000
         0         0         0    1.0000    1.5000    8.0000
         0         0         0         0         0         0
```

6. (a) First enter A and b and then let C be the augmented matrix.

```
>> A = [ 1 2 -2 0; 2 4 -1 0; -3 -6 12 2; 1 2 -2 -4];
>> b = [ 1; -4; -12; 3];
>> C = [A b]
C =
     1     2    -2     0     1
     2     4    -1     0    -4
    -3    -6    12     2   -12
     1     2    -2    -4     3
>> rref(C) % Reduce the augmented matrix.
ans =
     1     2     0     0     0
     0     0     1     0     0
     0     0     0     1     0
     0     0     0     0     1
```

Since the bottom row represents the equation $0x_1 + 0x_2 + 0x_3 + 0x_4 = 1$, which has no solution, the system has no solutions.

- (b)

```
>> b = 2*A(:,1) + A(:,2) + 3*A(:,3) - 4*A(:,4)
b =
    -2
     5
    16
    14
>> rref([A b])
ans =
     1     2     0     0     4
     0     0     1     0     3
     0     0     0     1    -4
     0     0     0     0     0
```

The solution is $x_4 = -4$, $x_3 = 3$, x_2 is arbitrary, and $x_1 = 4 - 2x_2$.

- (c) For any choice of coefficients, there will be a solution.
 (d) No, it is not possible. The conjecture is true. For any choice of a_i if

$$\mathbf{b} = a_1A(:, 1) + a_2A(:, 2) + a_3A(:, 3) + a_4A(:, 4),$$

then $A\mathbf{x} = \mathbf{b}$ will have at least the one solution $\mathbf{x}_i = a_i$.

- (e) Repeating the experiment will generate a random singular matrix A . In each case, if \mathbf{b} is a sum of multiples of columns of A , the system $[A \mathbf{b}]$ will have a solution.

7. (a)

```
>> A = [ 1 1 1 ; 2 3 4; -2 0 3 ];
>> b= [4; 9; -7 ];
>> c = [4; 16; 11 ];
>> Aug = [A b c]
Aug =
     1     1     1     4     4
     2     3     4     9    16
    -2     0     3    -7    11
>> rref(Aug)
ans =
     1     0     0     2    -1
     0     1     0     3     2
     0     0     1    -1     3
```

The solution to the first system is $\mathbf{x} = (2, 3, -1)$ and to the second is $\mathbf{x} = (-1, 2, 3)$.

(b)

```
>> A = [ 2 3 -4; 1 2 -3; -1 5 -11];
>> b = [ 1; 0; -7];
>> c = [-1; -1; -6];
>> d = [ 1; 2; -7];
>> Aug = [A b c d]
Aug =
     2     3    -4     1    -1     1
     1     2    -3     0    -1     2
    -1     5   -11    -7    -6    -7
>> rref(Aug)
ans =
     1     0     1     2     1     0
     0     1    -2    -1    -1     0
     0     0     0     0     0     1
```

For the first system, x_3 may be chosen arbitrarily, $x_1 = 2 - x_3$, $x_2 = -1 + 2x_3$. For the second system, x_3 may be chosen arbitrarily, $x_1 = 1 - x_3$, $x_2 = -1 + 2x_3$. The third system is inconsistent, and has no solutions.

- (c) Any columns will generate solutions using the same method as above.
- (d) (i) No. Since the number of variables that may be chosen arbitrarily is not determined by the right hand side, a system cannot have a unique solution with one right hand side and infinitely many solutions with another.
- (ii) No. A system will have no solutions only when it reduces to a system with zeros on the left hand side, and nonzeros on the right hand side, so one of the columns on the left will not have a pivot. However, if a system will have a unique solution if every column on the left has a pivot. Both cases cannot happen for the same left hand side.
- (iii) Yes. In (b) above, there were infinitely many solutions for the first two systems, but no solution for the third. This happened because there was a column on the left hand side without a pivot. This missing pivot may or may not appear on the right hand side, causing the system to be inconsistent or consistent.

8. (a) If we consider each node in numerical order we find the equations:

$$\begin{aligned}
 T_1 &= (100 + T_2 + T_4 + 50)/4, & \text{or} & & 4T_1 - T_2 - T_4 &= 150 \\
 T_2 &= (100 + T_3 + T_5 + T_1)/4, & \text{or} & & -T_1 + 4T_2 - T_3 - T_5 &= 100 \\
 T_3 &= (100 + 50 + T_6 + T_2)/4, & \text{or} & & -T_2 + 4T_3 - T_6 &= 150 \\
 T_4 &= (T_1 + T_5 + T_7 + 50)/4, & \text{or} & & -T_1 + 4T_4 - T_5 - T_7 &= 50 \\
 T_5 &= (T_2 + T_6 + T_8 + T_4)/4, & \text{or} & & -T_2 + 4T_5 - T_6 - T_8 &= 0 \\
 T_6 &= (T_3 + 50 + T_9 + T_5)/4, & \text{or} & & -T_3 - T_5 + 4T_6 - T_9 &= 50 \\
 T_7 &= (T_4 + T_8 + 0 + 50)/4, & \text{or} & & -T_4 + 4T_7 - T_8 &= 50 \\
 T_8 &= (T_4 + T_9 + 0 + T_7)/4, & \text{or} & & -T_5 - T_7 + 4T_8 - T_9 &= 0 \\
 T_9 &= (T_6 + 50 + 0 + T_8)/4, & \text{or} & & -T_6 - T_8 + 4T_9 &= 0
 \end{aligned}$$

To express the equations on the right as $AT = b$ we see that we can form the coefficient matrix A and the righthand side b as follows:

```
>> A = 4*eye(9); % The diagonal terms are all 4 and the non-zero
>> A(1,[2 4]) = -[1 1]; A(2,[1 3 5]) = -[1 1 1]; % off diagonals are -1
>> A(3,[2 6]) = -[1 1]; A(4,[1 5 7]) = -[1 1 1];
>> A(5,[2 6 8]) = -[1 1 1]; A(6,[3 5 9]) = -[1 1 1];
>> A(7,[4 8]) = -[1 1]; A(8,[5 7 9]) = -[1 1 1];
>> A(9,[6 8]) = -[1 1];
>> b=[ 150; 100; 150; 50; 0; 50; 50; 0; 50];
>> [A b] % Here is the augmented matrix for the system.
ans =
  4   -1   0   -1   0   0   0   0   0   150
 -1   4   -1   0   -1   0   0   0   0   100
  0   -1   4   0   0   -1   0   0   0   150
 -1   0   0   4   -1   0   -1   0   0   50
  0   -1   0   0   4   -1   0   -1   0   0
  0   0   -1   0   -1   4   0   0   -1   50
  0   0   0   -1   0   0   4   -1   0   50
  0   0   0   0   -1   0   -1   4   -1   0
  0   0   0   0   0   -1   0   -1   4   50
```

Notice that the non-zero terms are (relatively) near the diagonal; specifically there is a diagonal band about the main diagonal containing all non-zero entries.

b.

```
>> R = rref([A b]); % The initial 9x9 in rref([A b]) is I so
>> R(:,10)' % The solution is just the 10'th column
ans =
Columns 1 through 7
 65.0794  65.8730  65.0794  44.4444  33.3333  44.4444  29.3651
Columns 8 through 9
 23.0159  29.3651
```

i.e. $T_1 = 65.0794, T_2 = 65.8730, T_3 = 65.0794, T_4 = 44.4444, T_5 = 33.3333, T_6 = 44.4444, T_7 = 29.3651, T_8 = 23.0159, T_9 = 29.3651$.

c.

```
>>
>> y = (A\b); y'
ans =
Columns 1 through 7
 65.0794  65.8730  65.0794  44.4444  33.3333  44.4444  29.3651
Columns 8 through 9
 23.0159  29.3651
```

9. (a) First set A to be the matrix, and b to be the right hand side:

```
>> A = [ 1-.2  -0.5  -0.15;  -0.4  1-.1  -0.3;  -0.25  -0.5  1-.15; ]
A =
    0.8000    -0.5000   -0.1500
   -0.4000    0.9000   -0.3000
   -0.2500   -0.5000    0.8500
>> b = [10; 25; 20]
b =
    10
    25
    20
>> A\b
ans =
   110.3058
   118.7429
   125.8211
```

(b) (i) The value $a_{32} = .05$ tells us that industry 2 needs .05 units of output from industry 3 in order to manufacture one unit. The value $a_{33} = 0$ tells us that industry 3 needs none of its own output.

(ii) The augmented matrix will be:

```
>> A = [ 1-.2  -0.1  -0.3  300000
         -0.15  1-.25  -0.25  200000
         -0.1  -0.05  1-0  200000]
A =
   1.0e+05 *
    0.0000    0.0000    0.0000    3.0000
    0.0000    0.0000    0.0000    2.0000
    0.0000    0.0000    0.0000    2.0000
```

MATLAB has printed only the most significant digits, .8 is very small compared to 300,000 so it is rounded off to 0. It does, however, keep the smaller numbers in memory:

```
>> A(:, 1:3)
ans =
    0.8000   -0.1000   -0.3000
   -0.1500    0.7500   -0.2500
   -0.1000   -0.0500    1.0000
```

Also, A is printed using “scientific notation”. The “ $1.0e+05 *$ ” tells us that we must multiply every number in A by 100,000.

(iii)

```

>> R = rref(A) % This reduces A to row echelon form.
R =
  1.0e+05 *
    0.0000         0         0    5.3720
         0    0.0000         0    4.6645
         0         0    0.0000    2.7704
>> R(:,1:3) % This is the reduced echelon form of the coefficient part:
ans =
     1     0     0
     0     1     0
     0     0     1
>> x = R(:,4) % The solution vector.
x =
  1.0e+05 *
    5.3720
    4.6645
    2.7704

```

In order to balance supply and demand, industry 1 should make 537,200 units, industry 2 should make 466,450 units, and industry 3 should make 277,040 units, to 5 significant digits.

(iv)

```

>> format long
>> x
x =
  1.0e+05 *
  5.37197626654496
  4.66453674121406
  2.77042446371520
>> format

```

10. (a) The equation for each intersection will be: (The negation of each is also a valid equation).

$$\begin{array}{rcll}
 \text{at [1]} & x_1 & -x_3 & +x_5 = 200 \\
 \text{at [2]} & -x_1 + x_2 & & = 0 \\
 \text{at [3]} & & -x_2 + x_3 - x_4 & = -100 \\
 \text{at [4]} & & & x_4 - x_5 = -100
 \end{array}$$

(b)

```

>> A = [1  0 -1  0  1  200
        -1 1  0  0  0   0
         0 -1 1 -1  0 -100
         0  0  0  1 -1 -100 ];
>> rref(A)
ans =
     1     0    -1     0     1    200
     0     1    -1     0     1    200
     0     0     0     1    -1   -100
     0     0     0     0     0     0

```

We may choose x_3 and x_5 arbitrarily, then $x_1 = x_3 - x_5 + 200$, $x_2 = x_3 - x_5 + 200$ and $x_4 = x_5 - 100$.

(c) If we set $x_5 = 0$, then $x_4 = -100$, i.e. the traffic from [3] to [4] would have to be reversed. The smallest x_5 can be chosen is 100, in order to keep all of the other numbers nonnegative.

11. (a) As in the example, the equations to solve will be $Ax = b$, with:

```
>> A = [ 1^2 1 1; 3^2 3 1; 4^2 4 1]
A =
    1    1    1
    9    3    1
   16    4    1
>> b = [-1; 3; -2];
>> x = A\b
x =
  -2.3333
  11.3333
 -10.0000
```

The parabola will be $y = -2.3333x^2 + 11.3333x - 10$.

```
>> x = [1; 3; 4];
>> V = vander(x)
V =
    1    1    1
    9    3    1
   16    4    1
```

V is the same matrix as A .

(b) This is similar to (a), except we now need a third degree polynomial to fit four points:

```
>> A = [ 0^3 0^2 0 1; 1^3 1^2 1 1; 3^3 3^2 3 1; 4^3 4^2 4 1]
A =
    0    0    0    1
    1    1    1    1
   27    9    3    1
   64   16    4    1
>> b = [5; -2; 3; -2];
>> x = A\b
x =
  -1.4167
   8.8333
 -14.4167
   5.0000
```

The cubic polynomial will be $y = -1.4167x^3 + 8.8333x^2 - 14.4167x + 5$.

```
>> x = [0; 1; 3; 4];
>> V = vander(x)
V =
    0    0    0    1
    1    1    1    1
   27    9    3    1
   64   16    4    1
```

V is the same matrix as A .

(c) For part (a):

```
>> x = [1; 3; 4];
>> y = [-1; 3; -2];
>> V = vander(x);
>> c= V\y
c =
   -2.3333
    11.3333
   -10.0000
>> s= min(x):.01:max(x);
>> yy = polyval(c,s);
>> plot(x,y,'*',s,yy)
```

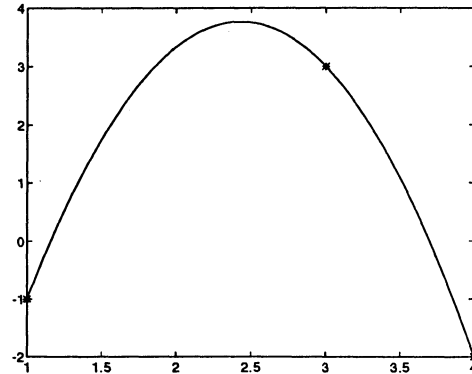

For part (b):

```
>> x = [0; 1; 3; 4];
>> y = [5; -2; 3; -2]
>> V = vander(x);
>> c= V\y
c =
   -1.4167
    8.8333
  -14.4167
    5.0000
>> s= min(x):.01:max(x);
>> yy = polyval(c,s);
>> plot(x,y,'*',s,yy)
```

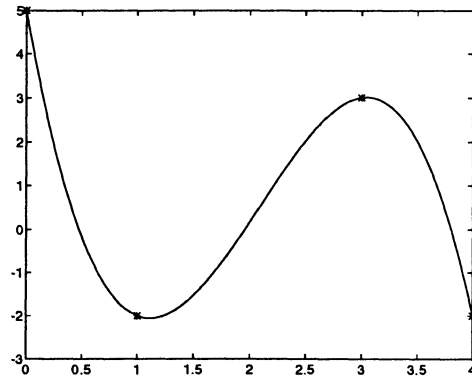

(d) This will generate a 7th degree polynomial, passing through each of the seven points.

```
>> x = rand(7,1)
x =
    0.0668
    0.4175
    0.6868
    0.5890
    0.9304
    0.8462
    0.5269
```

```
>> y = rand(7,1)
y =
    0.0920
    0.6539
    0.4160
    0.7012
    0.9103
    0.7622
    0.2625
```



```
>> V = vander(x);
>> c= V\y
c =
  1.0e+04 *
  -0.9529
   3.3259
  -4.6043
   3.1855
  -1.1279
   0.1808
  -0.0079
>> s= min(x):.01:max(x);
>> yy = polyval(c,s);
>> plot(x,y,'*',s,yy)
```

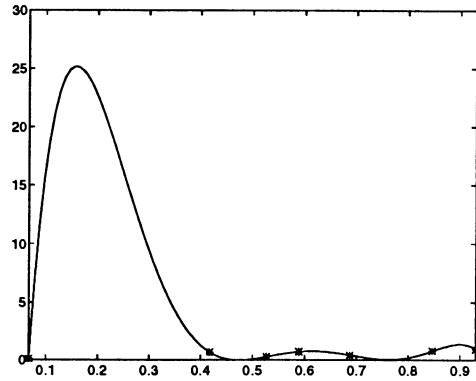

Notice that even though the y coordinates of the original points were all between 0 and 1, the resulting polynomial can oscillate dramatically.

Section 1.4

Note: Any variables appearing in a solution can take arbitrary values.

$$1. \begin{pmatrix} 2 & -1 & | & 0 \\ 3 & 4 & | & 0 \end{pmatrix} \rightarrow \begin{pmatrix} 1 & -1/2 & | & 0 \\ 0 & 11/2 & | & 0 \end{pmatrix} \rightarrow \begin{pmatrix} 1 & 0 & | & 0 \\ 0 & 1 & | & 0 \end{pmatrix}. \text{ Solution: } (0, 0).$$

$$2. \begin{pmatrix} 1 & -5 & | & 0 \\ -1 & 5 & | & 0 \end{pmatrix} \rightarrow \begin{pmatrix} 1 & -5 & | & 0 \\ 0 & 0 & | & 0 \end{pmatrix}. \text{ Solution: } (5x_2, x_2).$$

$$3. \begin{pmatrix} 1 & 1 & -1 & | & 0 \\ 2 & -4 & 3 & | & 0 \\ 3 & 7 & -1 & | & 0 \end{pmatrix} \rightarrow \begin{pmatrix} 1 & 1 & -1 & | & 0 \\ 0 & -6 & 5 & | & 0 \\ 0 & 4 & 2 & | & 0 \end{pmatrix} \rightarrow \begin{pmatrix} 1 & 0 & 1/6 & | & 0 \\ 0 & 1 & -5/6 & | & 0 \\ 0 & 0 & 16/3 & | & 0 \end{pmatrix} \rightarrow \begin{pmatrix} 1 & 0 & 0 & | & 0 \\ 0 & 1 & 0 & | & 0 \\ 0 & 0 & 1 & | & 0 \end{pmatrix}. \text{ Solution: } (0, 0, 0).$$

$$4. \begin{pmatrix} 1 & 1 & -1 & | & 0 \\ 2 & -4 & 3 & | & 0 \\ -1 & -7 & 6 & | & 0 \end{pmatrix} \rightarrow \begin{pmatrix} 1 & 1 & -1 & | & 0 \\ 0 & -6 & 5 & | & 0 \\ 0 & -6 & 5 & | & 0 \end{pmatrix} \rightarrow \begin{pmatrix} 1 & 0 & -1/6 & | & 0 \\ 0 & 1 & -5/6 & | & 0 \\ 0 & 0 & 0 & | & 0 \end{pmatrix}. \text{ Solution: } (x_3/6, 5x_3/6, x_3).$$

$$5. \begin{pmatrix} 1 & 1 & -1 & | & 0 \\ 2 & -4 & 3 & | & 0 \\ -5 & 13 & -10 & | & 0 \end{pmatrix} \rightarrow \begin{pmatrix} 1 & 1 & -1 & | & 0 \\ 0 & -6 & 5 & | & 0 \\ 0 & 18 & -15 & | & 0 \end{pmatrix} \rightarrow \begin{pmatrix} 1 & 0 & -1/6 & | & 0 \\ 0 & 1 & -5/6 & | & 0 \\ 0 & 0 & 0 & | & 0 \end{pmatrix}. \text{ Solution: } (x_3/6, 5x_3/6, x_3).$$

$$6. \begin{pmatrix} 2 & 3 & -1 & | & 0 \\ 6 & -5 & 7 & | & 0 \end{pmatrix} \rightarrow \begin{pmatrix} 1 & 3/2 & -1/2 & | & 0 \\ 0 & -14 & 10 & | & 0 \end{pmatrix} \rightarrow \begin{pmatrix} 1 & 0 & 4/7 & | & 0 \\ 0 & 1 & -5/7 & | & 0 \end{pmatrix}. \text{ Solution: } (-4x_3/7, 5x_3/7, x_3).$$

$$7. \begin{pmatrix} 4 & -1 & | & 0 \\ 7 & 3 & | & 0 \\ -8 & 6 & | & 0 \end{pmatrix} \rightarrow \begin{pmatrix} 1 & -1/4 & | & 0 \\ 0 & 19/4 & | & 0 \\ 0 & 4 & | & 0 \end{pmatrix} \rightarrow \begin{pmatrix} 1 & 0 & | & 0 \\ 0 & 1 & | & 0 \\ 0 & 0 & | & 0 \end{pmatrix}. \text{ Solution: } (0, 0).$$

$$8. \begin{pmatrix} 1 & -1 & 7 & -1 & | & 0 \\ 2 & 3 & -8 & 1 & | & 0 \end{pmatrix} \rightarrow \begin{pmatrix} 1 & -1 & 7 & -1 & | & 0 \\ 0 & 5 & -22 & 3 & | & 0 \end{pmatrix} \rightarrow \begin{pmatrix} 1 & 0 & 13/5 & -2/5 & | & 0 \\ 0 & 1 & -22/5 & 3/5 & | & 0 \end{pmatrix}.$$

Solution: $((-13x_3 + 2x_4)/5, (22x_3 - 3x_4)/5, x_3, x_4)$.

$$9. \begin{pmatrix} 1 & -2 & 1 & 1 & | & 0 \\ 3 & 0 & 2 & -2 & | & 0 \\ 0 & 4 & -1 & -1 & | & 0 \\ 5 & 0 & 3 & -1 & | & 0 \end{pmatrix} \rightarrow \begin{pmatrix} 1 & -2 & 1 & 1 & | & 0 \\ 0 & 6 & -1 & -5 & | & 0 \\ 0 & 4 & -1 & -1 & | & 0 \\ 0 & 10 & -2 & -6 & | & 0 \end{pmatrix} \rightarrow \begin{pmatrix} 1 & 0 & 2/3 & -2/3 & | & 0 \\ 0 & 1 & -1/6 & -5/6 & | & 0 \\ 0 & 0 & -1/3 & 7/3 & | & 0 \\ 0 & 0 & -1/3 & 7/3 & | & 0 \end{pmatrix} \rightarrow \begin{pmatrix} 1 & 0 & 0 & 4 & | & 0 \\ 0 & 1 & 0 & -2 & | & 0 \\ 0 & 0 & 1 & -7 & | & 0 \\ 0 & 0 & 0 & 0 & | & 0 \end{pmatrix}.$$

Solution: $(-4x_4, 2x_4, 7x_4, x_4)$.

$$10. \begin{pmatrix} -2 & 0 & 0 & 7 & | & 0 \\ 1 & 2 & -1 & 4 & | & 0 \\ 3 & 0 & -1 & 5 & | & 0 \\ 4 & 2 & 3 & 0 & | & 0 \end{pmatrix} \rightarrow \begin{pmatrix} 1 & 0 & 0 & -7/2 & | & 0 \\ 0 & -2 & 1 & -15/2 & | & 0 \\ 0 & 0 & -1 & 31/2 & | & 0 \\ 0 & 2 & 3 & 28/2 & | & 0 \end{pmatrix} \rightarrow \begin{pmatrix} 1 & 0 & 0 & -7/2 & | & 0 \\ 0 & -2 & -1/2 & 15/4 & | & 0 \\ 0 & 0 & -1 & 31/2 & | & 0 \\ 0 & 0 & 4 & 13/2 & | & 0 \end{pmatrix}$$

$$\rightarrow \begin{pmatrix} 1 & 0 & 0 & -7/2 & | & 0 \\ 0 & 1 & 0 & -4 & | & 0 \\ 0 & 0 & 1 & -31/2 & | & 0 \\ 0 & 0 & 0 & 155/2 & | & 0 \end{pmatrix} \rightarrow \begin{pmatrix} 1 & 0 & 0 & 0 & | & 0 \\ 0 & 1 & 0 & 0 & | & 0 \\ 0 & 0 & 1 & 0 & | & 0 \\ 0 & 0 & 0 & 1 & | & 0 \end{pmatrix}. \text{ Solution } (0, 0, 0, 0).$$

$$11. \left(\begin{array}{ccc|c} 2 & -1 & 0 & 0 \\ 3 & 5 & 0 & 0 \\ 7 & -3 & 0 & 0 \\ -2 & 3 & 0 & 0 \end{array} \right) \rightarrow \left(\begin{array}{ccc|c} 1 & -1/2 & 0 & 0 \\ 0 & 13/2 & 0 & 0 \\ 0 & 1/2 & 0 & 0 \\ 0 & 2 & 0 & 0 \end{array} \right) \rightarrow \left(\begin{array}{ccc|c} 1 & 0 & 0 & 0 \\ 0 & 1 & 0 & 0 \\ 0 & 0 & 0 & 0 \\ 0 & 0 & 0 & 0 \end{array} \right). \text{ Solution: } (0, 0).$$

$$12. \left(\begin{array}{ccc|c} 1 & -3 & 0 & 0 \\ -2 & 6 & 0 & 0 \\ 4 & -12 & 0 & 0 \end{array} \right) \rightarrow \left(\begin{array}{ccc|c} 1 & -3 & 0 & 0 \\ 0 & 0 & 0 & 0 \\ 0 & 0 & 0 & 0 \end{array} \right). \text{ Solution: } (3x_2, x_2).$$

$$13. \left(\begin{array}{ccc|c} 1 & 1 & -1 & 0 \\ 4 & -1 & 5 & 0 \\ -2 & 1 & -2 & 0 \\ 3 & 2 & -6 & 0 \end{array} \right) \rightarrow \left(\begin{array}{ccc|c} 1 & 1 & -1 & 0 \\ 0 & -5 & 9 & 0 \\ 0 & 3 & -4 & 0 \\ 0 & -1 & -3 & 0 \end{array} \right) \rightarrow \left(\begin{array}{ccc|c} 1 & 1 & -1 & 0 \\ 0 & -1 & -3 & 0 \\ 0 & 3 & -4 & 0 \\ 0 & -5 & 9 & 0 \end{array} \right) \rightarrow \left(\begin{array}{ccc|c} 1 & 0 & -4 & 0 \\ 0 & 1 & 3 & 0 \\ 0 & 0 & -13 & 0 \\ 0 & 0 & 24 & 0 \end{array} \right) \rightarrow \left(\begin{array}{ccc|c} 1 & 0 & 0 & 0 \\ 0 & 1 & 0 & 0 \\ 0 & 0 & 1 & 0 \\ 0 & 0 & 0 & 0 \end{array} \right).$$

Solution: $(0, 0, 0)$.

14. If $a_{11} = a_{21} = 0$, then x_1 is arbitrary and therefore infinitely many solutions and $a_{11}a_{22} - a_{12}a_{21} = 0$. If either a_{11} or a_{21} is non-zero, (say $a_{11} \neq 0$), then

$$\left(\begin{array}{cc|c} a_{11} & a_{12} & 0 \\ a_{21} & a_{22} & 0 \end{array} \right) \rightarrow \left(\begin{array}{cc|c} 1 & a_{12}/a_{11} & 0 \\ 0 & (a_{11}a_{22} - a_{12}a_{21})/a_{11} & 0 \end{array} \right)$$

There will be an infinite number of solutions when $a_{11} \neq 0$ if and only if $(a_{11}a_{22} - a_{12}a_{21})/a_{11} = 0$. This is true if and only if $a_{11}a_{22} - a_{12}a_{21} = 0$. Similarly $a_{22} \neq 0$, get infinite solutions if and only if $a_{11}a_{22} - a_{12}a_{21} = 0$.

$$15. \left(\begin{array}{ccc|c} 2 & -3 & 5 & 0 \\ -1 & 7 & -1 & 0 \\ 4 & -11 & k & 0 \end{array} \right) \rightarrow \left(\begin{array}{ccc|c} 1 & -3/2 & 5/2 & 0 \\ 0 & 11/2 & 3/2 & 0 \\ 0 & -5 & k-10 & 0 \end{array} \right) \rightarrow \left(\begin{array}{ccc|c} 1 & 0 & 32/11 & 0 \\ 0 & 1 & 3/11 & 0 \\ 0 & 0 & k-95/11 & 0 \end{array} \right). \text{ In order to have a non-trivial}$$

solution, we need $k - 95/11 = 0$. Therefore, $k = 95/11$.

16. Repeat the solution to Problem 43 in Section 1.3 to see that for a unique solution we need $a_{11}a_{22}a_{33} - a_{11}a_{23}a_{32} - a_{12}a_{21}a_{33} + a_{12}a_{23}a_{31} + a_{13}a_{21}a_{32} - a_{13}a_{22}a_{31} \neq 0$.

CALCULATOR SOLUTIONS 1.4

Refer to the CALCULATOR SOLUTIONS 1.3 to review the conventions followed in presenting TI-85 solutions. If the input for one of these homogeneous systems can be obtained by simple modifications to the (saved) input for a previous problem, the solution will outline how to do that. Sometimes the appropriate augmented matrix can be formed by extracting the coefficient submatrix (of a previous augmented matrix) and augmenting with a new right hand side, consisting of all zeros. At other times an entire new row will be added to an existing (augmented) matrix by first copying the previous matrix to a new variable and then editing the new matrix using the $\boxed{2\text{nd}}$ $\boxed{\text{MATRX}}$ $\langle\text{EDIT}\rangle$ menu entry, which allows changing dimensions and specifying specific elements of the matrix being edited. Also recall that the TI-85 recognizes both `rref` and `RREF` as a name for the `MATRX ops rref` reduced row echelon form function. (It is slightly easier to key in the all upper case version of most function names.)

17. This is the homogeneous system associated to Section 1.3, Problem 54. To solve it we form A1417 by $\boxed{2\text{nd}}$ $\boxed{\text{MATRX}}$ $\langle\text{ops}\rangle$ $\boxed{\text{MORE}}$ $\boxed{\text{F1}}$ $\langle\text{aug}\rangle$ A1354 (1, 1, 2, 3), [0,0] $\boxed{\text{STO}\blacktriangleright}$ A1417. Then from the equivalent system derived from `RREF A1417`:

$$\begin{bmatrix} 1 & 0 & -1.66206896552 & 0 \\ 0 & 1 & -.002298850575 & 0 \end{bmatrix}$$

we find that the solutions are $(1.66206896552x_3, 2.29885057472E-3x_3, x_3)$ with x_3 arbitrary.

18. This is the homogeneous system associated to Problem 55 in Section 1.3. We use

`RREF (AUG (A1355 (1, 1, 3, 4), [0, 0, 0]))` $\boxed{\text{ENTER}}$ to produce the reduced echelon form:

$$\begin{bmatrix} 1 & 0 & -1.27469748219 & 0 \\ 0 & 1 & .403399919808 & 0 \\ 0 & 0 & 0 & 0 \end{bmatrix}$$

from which we find the solutions are $(1.27469748219x_3, .403399919808x_3, x_3)$ with x_3 arbitrary.

19. We input the augmented matrix A1419 by $\llbracket [25, -16, 13, 33, -57, 0] [-16, 3, 1, 0, 12, 0] [0, -8, 0, 16, -26, 0] \rrbracket$ $\boxed{\text{STO}\blacktriangleright}$ A1419, being careful to get the zero's in the correct places to represent the missing variables. Then from `RREF A1419`:

$$\begin{bmatrix} 1 & 0 & 0 & -.330472103004 & -.146995708155 & 0 \\ 0 & 1 & 0 & -2 & 3.25 & 0 \\ 0 & 0 & 1 & .712446351931 & -.101931330472 & 0 \end{bmatrix}$$

we find both x_4 and x_5 arbitrary and the solutions are $(.330472103004x_4 + .146995708155x_5, 2x_4 - 3.25x_5, -.712446351931x_4 + .101931330472x_5, x_4, x_5)$.

20. The first three equations have the same coefficients as Section 53, Problem 57, so A1420 can be formed by A1357 $\boxed{\text{STO}\blacktriangleright}$ A1420, and using $\boxed{\text{MATRX}}$ $\langle\text{EDIT}\rangle$ A1420 $\boxed{\text{ENTER}}$ to edit this new augmented matrix. First we change the number of rows to 4 and leave the number of columns at 6 by 4 $\boxed{\text{ENTER}}$ $\boxed{\text{ENTER}}$ and then we use the arrow keys and $\langle\text{C}\blacktriangleright\text{1}\blacktriangleright\rangle$ to edit the bottom row to contain -1, 11, -9, 13, -20 and 0. Finally we make the last (6'th) column all zeros. Now from `RREF A1420`:

```
[ [ 1 0 0 0 -.288096195186 0 ]  
  [ 0 1 0 0 -1.00777740881 0 ]  
  [ 0 0 1 0 -1.28332488596 0 ]  
  [ 0 0 0 1 -1.59634374399 0 ] ]
```

we see the solutions are $(.288096195186x_5, 1.00777740881x_5, 1.28332488596x_5, 1.59634374399x_5, x_5)$ with x_5 arbitrary.

MATLAB 1.4

1. (a) One example: (your answer will differ).

```
>> A = rand(3,4)
A =
    0.0331    0.9554    0.8907    0.1598
    0.5344    0.7483    0.6248    0.2128
    0.4985    0.5546    0.8420    0.7147
```

- (b)

```
>> rref(A)
ans =
    1.0000         0         0    0.3685
         0    1.0000         0   -1.1232
         0         0    1.0000    1.3704
```

- (c) The solution of this system has x_4 arbitrary, $x_1 = -0.3685x_4$, $x_2 = 1.1232x_4$, and $x_3 = -1.3704x_4$, since $Ax = 0$ is equivalent to $\text{ans} * x = 0$. The associated homogeneous equation has more unknowns than equations, which gives a non-pivot column. Since a variable can be chosen arbitrarily, there are an infinite number of solutions, as predicted in Theorem 1.
2. *Most* matrices with more rows than columns will have only one solution to the homogeneous system. However, it is not true that *all* of them do. The matrix in (ii), for example, does not.

- (i)

```
>> A = [ 1 2 3 0; -1 4 5 -1; 0 2 -6 2; 1 1 1 3; 0 2 0 1]
A =
     1     2     3     0
    -1     4     5    -1
     0     2    -6     2
     1     1     1     3
     0     2     0     1

>> rref(A)
ans =
     1     0     0     0
     0     1     0     0
     0     0     1     0
     0     0     0     1
     0     0     0     0
```

There is a unique solution, $x = 0$, to $Ax = 0$.

- (ii)

```
>> A = [ 1 -1 3; 2 1 3; 0 2 -2; 4 4 4]
A =
     1    -1     3
     2     1     3
     0     2    -2
     4     4     4

>> rref(A)
ans =
     1     0     2
     0     1    -1
     0     0     0
     0     0     0
```

Since column 3 has no pivot, the solution will have x_3 arbitrary, $x_1 = -2x_3$, and $x_2 = 1x_3$. There are an infinite number of solutions to the homogeneous equation.

3. "Balancing" will lead to a homogeneous system because any solution, x will lead to another solution by scaling rx . In order to get a unique solution, we must require that x is made of positive integers with no common divisor.

(a) The solution for the example will be:

```
>> A = [ 1 0 -6 0
         2 1 -6 -2
         0 2 -12 0 ];
>> R = rref(A)
R =
    1.0000         0         0   -1.0000
         0    1.0000         0   -1.0000
         0         0    1.0000  -0.1667
>> format rat % Use this in version 4.0 in order to view
              % output as rational numbers.
>> z = R(:,4)
z =
    -1
    -1
   -1/6
>> format % This returns to the standard output format.
```

From this, we can see that if x_4 is chosen to be 6, then $x_3 = 1$, $x_2 = 6$ and $x_1 = 6$. With this choice, there will be no common divisors, and all of the variables are positive integers.

- (b) First we set up the equations, x_1 and x_2 will correspond to the compounds on the left and x_3 through x_6 for those on the right. Once we subtract the right from the left, all of the coefficients from the right will be negative:

```
>> format rat % as above, use rational numbers in the output.
>> A = [ 1 0 -0 -0 -3 0 % Those with Pb.
         3*2 0 -0 -0 -0 -1 % Those with N.
         0 1 -2 -0 -0 -0 % Those with Cr.
         0 2 -0 -1 -0 -0 % Those with Mn.
         0 4*2 -3 -2 -4 -1 ] % Those with O.
A =
    1         0         0         0        -3         0
    6         0         0         0         0        -1
    0         1        -2         0         0         0
    0         2         0        -1         0         0
    0         8        -3        -2        -4        -1
>> rref(A)
ans =
    1         0         0         0         0        -1/6
    0         1         0         0         0       -22/45
    0         0         1         0         0       -11/45
    0         0         0         1         0       -44/45
    0         0         0         0         1       -1/18
>> format % As above, it is a good idea to return to the default format.
```

From the reduced echelon form of A , we can see that in order to make all of the variables integers, x_6 must be chosen to be the least common multiple of 45, 6, and 18, which is 90. With this we get the answer: $x_1 = 15$, $x_2 = 44$, $x_3 = 22$, $x_4 = 88$, $x_5 = 5$, $x_6 = 90$.

Section 1.5

$$1. \begin{pmatrix} -3 \\ 1 \\ 4 \end{pmatrix} + \begin{pmatrix} 5 \\ -4 \\ 7 \end{pmatrix} = \begin{pmatrix} 2 \\ -3 \\ 11 \end{pmatrix} \quad 2. 3 \begin{pmatrix} 5 \\ -4 \\ 7 \end{pmatrix} = \begin{pmatrix} 15 \\ -12 \\ 21 \end{pmatrix} \quad 3. -2 \begin{pmatrix} 2 \\ 0 \\ -2 \end{pmatrix} = \begin{pmatrix} -4 \\ 0 \\ 4 \end{pmatrix}$$

$$4. \begin{pmatrix} 5 \\ -4 \\ 7 \end{pmatrix} + \begin{pmatrix} 6 \\ 0 \\ -6 \end{pmatrix} = \begin{pmatrix} 11 \\ -4 \\ 1 \end{pmatrix} \quad 5. 2 \begin{pmatrix} -3 \\ 1 \\ 4 \end{pmatrix} - 5 \begin{pmatrix} 5 \\ -4 \\ 7 \end{pmatrix} = \begin{pmatrix} -31 \\ 22 \\ -27 \end{pmatrix}$$

$$6. \begin{pmatrix} -15 \\ 12 \\ -21 \end{pmatrix} + \begin{pmatrix} 4 \\ 0 \\ -4 \end{pmatrix} = \begin{pmatrix} -11 \\ 12 \\ -25 \end{pmatrix} \quad 7. 0 \begin{pmatrix} 2 \\ 0 \\ -2 \end{pmatrix} = \begin{pmatrix} 0 \\ 0 \\ 0 \end{pmatrix} = \mathbf{0} \quad 8. \begin{pmatrix} 4 \\ -3 \\ 9 \end{pmatrix}$$

$$9. \begin{pmatrix} -9 \\ 3 \\ 12 \end{pmatrix} - \begin{pmatrix} 10 \\ -8 \\ 14 \end{pmatrix} + \begin{pmatrix} 8 \\ 0 \\ -8 \end{pmatrix} = \begin{pmatrix} -11 \\ 11 \\ -10 \end{pmatrix} \quad 10. \begin{pmatrix} 15 \\ -12 \\ 21 \end{pmatrix} - \begin{pmatrix} 14 \\ 0 \\ -14 \end{pmatrix} + \begin{pmatrix} -6 \\ 2 \\ 8 \end{pmatrix} = \begin{pmatrix} -5 \\ -10 \\ 43 \end{pmatrix}$$

$$11. (3, -1, 4, 2) + (-2, 3, 1, 5) = (1, 2, 5, 7) \quad 12. (6, 0, -1, 4) - (3, -1, 4, 2) = (3, 1, -5, 2)$$

$$13. 4(-2, 3, 1, 5) = (-8, 12, 4, 20) \quad 14. (-12, 0, 2, -8) \quad 15. (6, -2, 8, 4) - (-2, 3, 1, 5) = (8, -5, 7, -1)$$

$$16. (24, 0, -4, 16) - (21, -7, 28, 14) = (3, 7, -32, 2)$$

$$17. (7, 2, 4, 11) \quad 18. (-2, 1, 10, 5) \quad 19. (-11, 9, 18, 18)$$

$$20. (3\alpha + 6\beta - 2\gamma, -\alpha + 3\gamma, 4\alpha - \beta + \gamma, 2\alpha + 4\beta + 5\gamma)$$

$$21. 3 \begin{pmatrix} 1 & 3 \\ 2 & 5 \\ -1 & 2 \end{pmatrix} = \begin{pmatrix} 3 & 9 \\ 6 & 16 \\ -3 & 6 \end{pmatrix}$$

$$22. \begin{pmatrix} 1 & 3 \\ 2 & 5 \\ -1 & 2 \end{pmatrix} + \begin{pmatrix} -2 & 0 \\ 1 & 4 \\ -7 & 5 \end{pmatrix} = \begin{pmatrix} -1 & 3 \\ 3 & 9 \\ -8 & 7 \end{pmatrix}$$

$$23. \begin{pmatrix} 1 & 3 \\ 2 & 5 \\ -1 & 2 \end{pmatrix} - \begin{pmatrix} -1 & 1 \\ 4 & 6 \\ -7 & 3 \end{pmatrix} = \begin{pmatrix} 2 & 2 \\ -2 & -1 \\ 6 & -1 \end{pmatrix}$$

$$24. 2 \begin{pmatrix} -1 & 1 \\ 4 & 6 \\ -7 & 3 \end{pmatrix} - 5 \begin{pmatrix} 1 & 3 \\ 2 & 5 \\ -1 & 2 \end{pmatrix} = \begin{pmatrix} -2 & 2 \\ 8 & 12 \\ -14 & 6 \end{pmatrix} - \begin{pmatrix} 5 & 15 \\ 10 & 25 \\ -5 & 10 \end{pmatrix} = \begin{pmatrix} -7 & -13 \\ -2 & -13 \\ -9 & -4 \end{pmatrix}$$

$$25. 0 \begin{pmatrix} -2 & 0 \\ 1 & 4 \\ -7 & 5 \end{pmatrix} = \begin{pmatrix} 0 & 0 \\ 0 & 0 \\ 0 & 0 \end{pmatrix}$$

$$26. -7 \begin{pmatrix} 1 & 3 \\ 2 & 5 \\ -1 & 2 \end{pmatrix} + 3 \begin{pmatrix} -2 & 0 \\ 1 & 4 \\ -7 & 5 \end{pmatrix} = \begin{pmatrix} -7 & -21 \\ -14 & -35 \\ 7 & -14 \end{pmatrix} + \begin{pmatrix} -6 & 0 \\ 3 & 12 \\ -21 & 15 \end{pmatrix} = \begin{pmatrix} -13 & -21 \\ -11 & -23 \\ -14 & 1 \end{pmatrix}$$

$$27. \begin{pmatrix} 1 & 3 \\ 2 & 5 \\ -1 & 2 \end{pmatrix} + \begin{pmatrix} -2 & 0 \\ 1 & 4 \\ -7 & 5 \end{pmatrix} + \begin{pmatrix} -1 & 1 \\ 4 & 6 \\ -7 & 3 \end{pmatrix} = \begin{pmatrix} -2 & 4 \\ 7 & 15 \\ -15 & 10 \end{pmatrix}$$

$$28. \begin{pmatrix} -1 & 1 \\ 4 & 6 \\ -7 & 3 \end{pmatrix} - \begin{pmatrix} 1 & 3 \\ 2 & 5 \\ -1 & 2 \end{pmatrix} - \begin{pmatrix} -2 & 0 \\ 1 & 4 \\ -7 & 5 \end{pmatrix} = \begin{pmatrix} 0 & -2 \\ 1 & -3 \\ 1 & -4 \end{pmatrix}$$

$$29. 2 \begin{pmatrix} 1 & 3 \\ 2 & 5 \\ -1 & 2 \end{pmatrix} - 3 \begin{pmatrix} -2 & 0 \\ 1 & 4 \\ -7 & 5 \end{pmatrix} + 4 \begin{pmatrix} -1 & 1 \\ 4 & 6 \\ -7 & 3 \end{pmatrix} = \begin{pmatrix} 2 & 6 \\ 4 & 10 \\ -2 & 4 \end{pmatrix} - \begin{pmatrix} -6 & 0 \\ 3 & 12 \\ -21 & 15 \end{pmatrix} + \begin{pmatrix} -4 & 4 \\ 16 & 24 \\ -28 & 12 \end{pmatrix} \\ = \begin{pmatrix} 4 & 10 \\ 17 & 22 \\ -9 & 1 \end{pmatrix}$$

$$30. 7 \begin{pmatrix} -1 & 1 \\ 4 & 6 \\ -7 & 3 \end{pmatrix} - \begin{pmatrix} -2 & 0 \\ 1 & 4 \\ -7 & 5 \end{pmatrix} + 2 \begin{pmatrix} 1 & 3 \\ 2 & 5 \\ -1 & 2 \end{pmatrix} = \begin{pmatrix} -7 & 7 \\ 28 & 42 \\ -49 & 21 \end{pmatrix} - \begin{pmatrix} -2 & 0 \\ 1 & 4 \\ -7 & 5 \end{pmatrix} + \begin{pmatrix} 2 & 6 \\ 4 & 10 \\ -2 & 4 \end{pmatrix}$$

$$31. 2A + B - D = O, \text{ says } D = 2A + B = \begin{pmatrix} 0 & 6 \\ 5 & 14 \\ -9 & 9 \end{pmatrix}$$

$$32. A + 2B - 3C + E = O \text{ says } E = 3C - 2B - A = \begin{pmatrix} 0 & 0 \\ 8 & 5 \\ -6 & -3 \end{pmatrix}$$

$$33. \begin{pmatrix} 1 & -1 & 2 \\ 3 & 4 & 5 \\ 0 & 1 & -1 \end{pmatrix} - 2 \begin{pmatrix} 0 & 2 & 1 \\ 3 & 0 & 5 \\ 7 & -6 & 0 \end{pmatrix} = \begin{pmatrix} 1 & -1 & 2 \\ 3 & 4 & 5 \\ 0 & 1 & -1 \end{pmatrix} - \begin{pmatrix} 0 & 4 & 2 \\ 6 & 0 & 10 \\ 14 & -12 & 0 \end{pmatrix} = \begin{pmatrix} 1 & -5 & 0 \\ -3 & 4 & -5 \\ -14 & 13 & -1 \end{pmatrix}$$

$$34. 3 \begin{pmatrix} 1 & -1 & 2 \\ 3 & 4 & 5 \\ 0 & 1 & -1 \end{pmatrix} - \begin{pmatrix} 0 & 0 & 2 \\ 3 & 1 & 0 \\ 0 & -2 & 4 \end{pmatrix} = \begin{pmatrix} 3 & -3 & 6 \\ 9 & 12 & 15 \\ 0 & 3 & -3 \end{pmatrix} - \begin{pmatrix} 0 & 0 & 2 \\ 3 & 1 & 0 \\ 0 & -2 & 4 \end{pmatrix} = \begin{pmatrix} 3 & -3 & 4 \\ 6 & 11 & 15 \\ 0 & 5 & -7 \end{pmatrix}$$

$$35. \begin{pmatrix} 1 & -1 & 2 \\ 3 & 4 & 5 \\ 0 & 1 & -1 \end{pmatrix} + \begin{pmatrix} 0 & 2 & 1 \\ 3 & 0 & 5 \\ 7 & -6 & 0 \end{pmatrix} + \begin{pmatrix} 0 & 0 & 2 \\ 3 & 1 & 0 \\ 0 & -2 & 4 \end{pmatrix} = \begin{pmatrix} 1 & 1 & 5 \\ 9 & 5 & 10 \\ 7 & -7 & 3 \end{pmatrix}$$

$$\begin{aligned}
 36. \quad & 2 \begin{pmatrix} 1 & -1 & 2 \\ 3 & 4 & 5 \\ 0 & 1 & -1 \end{pmatrix} - \begin{pmatrix} 0 & 2 & 1 \\ 3 & 0 & 5 \\ 7 & -6 & 0 \end{pmatrix} + 2 \begin{pmatrix} 0 & 0 & 2 \\ 3 & 1 & 0 \\ 0 & -2 & 4 \end{pmatrix} \\
 & = \begin{pmatrix} 2 & -2 & 4 \\ 6 & 8 & 10 \\ 0 & 2 & -2 \end{pmatrix} - \begin{pmatrix} 0 & 2 & 1 \\ 3 & 0 & 5 \\ 7 & -6 & 0 \end{pmatrix} + \begin{pmatrix} 0 & 0 & 4 \\ 6 & 2 & 0 \\ 0 & -4 & 4 \end{pmatrix} = \begin{pmatrix} 2 & -4 & 7 \\ 9 & 10 & 5 \\ -7 & 4 & 2 \end{pmatrix}
 \end{aligned}$$

$$37. \quad \begin{pmatrix} 0 & 0 & 2 \\ 3 & 1 & 0 \\ 0 & -2 & 4 \end{pmatrix} - \begin{pmatrix} 1 & -1 & 2 \\ 3 & 4 & 5 \\ 0 & 1 & -1 \end{pmatrix} - \begin{pmatrix} 0 & 2 & 1 \\ 3 & 0 & 5 \\ 7 & -6 & 0 \end{pmatrix} = \begin{pmatrix} -1 & -1 & -1 \\ -3 & -3 & -10 \\ -7 & 3 & 5 \end{pmatrix}$$

$$\begin{aligned}
 38. \quad & 4 \begin{pmatrix} 0 & 0 & 2 \\ 3 & 1 & 0 \\ 0 & -2 & 4 \end{pmatrix} - 2 \begin{pmatrix} 0 & 2 & 1 \\ 3 & 0 & 5 \\ 7 & -6 & 0 \end{pmatrix} + 3 \begin{pmatrix} 1 & -1 & 2 \\ 3 & 4 & 5 \\ 0 & 1 & -1 \end{pmatrix} \\
 & = \begin{pmatrix} 0 & 0 & 8 \\ 12 & 4 & 0 \\ 0 & -8 & 16 \end{pmatrix} - \begin{pmatrix} 0 & 4 & 2 \\ 6 & 0 & 10 \\ 14 & -12 & 0 \end{pmatrix} + \begin{pmatrix} 3 & -3 & 6 \\ 9 & 12 & 15 \\ 0 & 3 & -3 \end{pmatrix} = \begin{pmatrix} 3 & -7 & 12 \\ 15 & 16 & 5 \\ -14 & 7 & 13 \end{pmatrix}
 \end{aligned}$$

$$39. \quad D = -A - B - C = \begin{pmatrix} -1 & -1 & -5 \\ -9 & -5 & -10 \\ -7 & 7 & -3 \end{pmatrix}$$

$$40. \quad A + 2B - 3C - 4E = O \text{ says } 4E = 3C - 2B + 8A. \text{ Divide by 4 to get } E = \frac{1}{4}[3C - 2B + 8A]$$

$$\begin{aligned}
 & = \frac{1}{4} \left[\begin{pmatrix} 0 & 0 & 6 \\ 9 & 3 & 0 \\ 0 & -6 & 12 \end{pmatrix} - \begin{pmatrix} 0 & 4 & 2 \\ 6 & 0 & 10 \\ 14 & -12 & 0 \end{pmatrix} + \begin{pmatrix} 8 & -8 & 16 \\ 24 & 32 & 40 \\ 0 & 8 & -8 \end{pmatrix} \right] \\
 & = \begin{pmatrix} 2 & -3 & 5 \\ 27/4 & 35/4 & 15/2 \\ -7/2 & 7/2 & 1 \end{pmatrix}
 \end{aligned}$$

$$41. \quad 0 \begin{pmatrix} a_{11} & a_{12} & \cdots & a_{1n} \\ \vdots & & & \vdots \\ a_{m1} & a_{m2} & \cdots & a_{mn} \end{pmatrix} = \begin{pmatrix} 0 \cdot a_{11} & 0 \cdot a_{12} & \cdots & 0 \cdot a_{1n} \\ \vdots & & & \vdots \\ 0 \cdot a_{m1} & 0 \cdot a_{m2} & \cdots & 0 \cdot a_{mn} \end{pmatrix} = \begin{pmatrix} 0 & \cdots & 0 \\ \vdots & & \vdots \\ 0 & \cdots & 0 \end{pmatrix} = \bar{0}$$

$$\begin{pmatrix} 0 & \cdots & 0 \\ \vdots & & \vdots \\ 0 & \cdots & 0 \end{pmatrix} + \begin{pmatrix} a_{11} & a_{12} & \cdots & a_{1n} \\ \vdots & & & \vdots \\ a_{m1} & a_{m2} & \cdots & a_{mn} \end{pmatrix} = \begin{pmatrix} 0 + a_{11} & 0 + a_{12} & \cdots & 0 + a_{1n} \\ \vdots & & & \vdots \\ 0 + a_{m1} & 0 + a_{m2} & \cdots & 0 + a_{mn} \end{pmatrix}$$

$$= \begin{pmatrix} a_{11} & a_{12} & \cdots & a_{1n} \\ \vdots & & & \vdots \\ a_{m1} & a_{m2} & \cdots & a_{mn} \end{pmatrix} = A$$

$$1 \begin{pmatrix} a_{11} & a_{12} & \cdots & a_{1n} \\ \vdots & & & \vdots \\ a_{m1} & a_{m2} & \cdots & a_{mn} \end{pmatrix} = \begin{pmatrix} 1 \cdot a_{11} & 1 \cdot a_{12} & \cdots & 1 \cdot a_{1n} \\ \vdots & & & \vdots \\ 1 \cdot a_{m1} & 1 \cdot a_{m2} & \cdots & 1 \cdot a_{mn} \end{pmatrix} = \begin{pmatrix} a_{11} & a_{12} & \cdots & a_{1n} \\ \vdots & & & \vdots \\ a_{m1} & a_{m2} & \cdots & a_{mn} \end{pmatrix} = A$$

$$\begin{aligned}
 42. (A + B) + C &= \left[\begin{pmatrix} a_{11} & a_{12} & \cdots & a_{1n} \\ \vdots & & & \vdots \\ a_{m1} & a_{m2} & \cdots & a_{mn} \end{pmatrix} + \begin{pmatrix} b_{11} & b_{12} & \cdots & b_{1n} \\ \vdots & & & \vdots \\ b_{m1} & b_{m2} & \cdots & b_{mn} \end{pmatrix} \right] + \begin{pmatrix} c_{11} & c_{12} & \cdots & c_{1n} \\ \vdots & & & \vdots \\ c_{m1} & c_{m2} & \cdots & c_{mn} \end{pmatrix} \\
 &= \begin{pmatrix} (a_{11} + b_{11}) + c_{11} & (a_{12} + b_{12}) + c_{12} & \cdots & (a_{1n} + b_{1n}) + c_{1n} \\ \vdots & & & \vdots \\ (a_{m1} + b_{m1}) + c_{m1} & (a_{m2} + b_{m2}) + c_{m2} & \cdots & (a_{mn} + b_{mn}) + c_{mn} \end{pmatrix} \\
 &= \begin{pmatrix} a_{11} + (b_{11} + c_{11}) & a_{12} + (b_{12} + c_{12}) & \cdots & a_{1n} + (b_{1n} + c_{1n}) \\ \vdots & & & \vdots \\ a_{m1} + (b_{m1} + c_{m1}) & a_{m2} + (b_{m2} + c_{m2}) & \cdots & a_{mn} + (b_{mn} + c_{mn}) \end{pmatrix} \\
 &= A + (B + C)
 \end{aligned}$$

43. If $A = (a_{ij})$ and $B = (b_{ij})$, then $\alpha(A + B) = \alpha((a_{ij}) + (b_{ij})) = \alpha(a_{ij} + b_{ij}) = (\alpha(a_{ij} + b_{ij}))$.

$$\alpha A + \alpha B = \alpha(a_{ij}) + \alpha(b_{ij}) = (\alpha a_{ij}) + (\alpha b_{ij}) = (\alpha a_{ij} + \alpha b_{ij}) = (\alpha(a_{ij} + b_{ij})), \text{ and}$$

Therefore $\alpha(A + B) = \alpha A + \alpha B$. Similarly,

$$(\alpha + \beta)A = (\alpha + \beta)(a_{ij}) = ((\alpha + \beta)a_{ij}) = (\alpha a_{ij} + \beta a_{ij}).$$

$$\alpha A + \beta A = \alpha(a_{ij}) + \beta(a_{ij}) = (\alpha a_{ij}) + (\beta a_{ij}) = (\alpha a_{ij} + \beta a_{ij})$$

Therefore $(\alpha + \beta)A = \alpha A + \beta A$.

$$44. \begin{pmatrix} 0 & 1 & 1 & 0 \\ 1 & 0 & 1 & 0 \\ 1 & 1 & 0 & 1 \\ 0 & 0 & 1 & 0 \end{pmatrix} \qquad 45. \begin{pmatrix} 0 & 1 & 0 & 1 & 0 \\ 1 & 0 & 1 & 1 & 0 \\ 0 & 1 & 0 & 0 & 1 \\ 1 & 1 & 0 & 0 & 0 \\ 0 & 0 & 1 & 0 & 0 \end{pmatrix}$$

46. The entries of $\mathbf{d} + \mathbf{e}$ represent the demand for all four raw materials if each factory is to produce 1 unit. $2\mathbf{d}$ gives the total raw material needs for factory 1 to produce 2 units.

MATLAB 1.5

1. (a)

```

>> A = [ 1  2 -2  0  1
         2  4 -1  0 -4
        -3 -6 12  2 -12
         1  2 -2 -4 -5 ]
A =
     1     2    -2     0     1
     2     4    -1     0    -4
    -3    -6    12     2   -12
     1     2    -2    -4    -5
>> % Choose A(1,1) as the first pivot.
>> c = -A(2,1)/A(1,1); A(2,:) = A(2,:) + c*A(1,:);
>> c = -A(3,1)/A(1,1); A(3,:) = A(3,:) + c*A(1,:);
>> c = -A(4,1)/A(1,1); A(4,:) = A(4,:) + c*A(1,:);
A =
     1     2    -2     0     1
     0     0     3     0    -6
     0     0     6     2    -9
     0     0     0    -4    -6
>> % Now let A(2,3) be the pivot.
>> c = -A(3,3)/A(2,3); A(3,:) = A(3,:) + c*A(2,:);
A =
     1     2    -2     0     1
     0     0     3     0    -6
     0     0     0     2     3
     0     0     0    -4    -6
>> % Now let A(3,4) be the pivot.
>> c = -A(4,4)/A(3,4); A(4,:) = A(4,:) + c*A(3,:);
A =
     1     2    -2     0     1
     0     0     3     0    -6
     0     0     0     2     3
     0     0     0     0     0

```

This matrix is now in echelon form.

(b) Recall that `rand` generates a random matrix, so your answer will be different.

```

>> A = rand(4,5);
>> A(:,3) = 2*A(:,1) + 4*A(:,2);
A =
    0.5269    0.7012    3.8586    0.7564    0.9826
    0.0920    0.9103    3.8252    0.9910    0.7227
    0.6539    0.7622    4.3566    0.3653    0.7534
    0.4160    0.2625    1.8818    0.2470    0.6515
>> % Choose A(1,1) as the first pivot.
>> c = -A(2,1)/A(1,1); A(2,:) = A(2,:) + c*A(1,:);
>> c = -A(3,1)/A(1,1); A(3,:) = A(3,:) + c*A(1,:);
>> c = -A(4,1)/A(1,1); A(4,:) = A(4,:) + c*A(1,:);

```

```

A =
    0.5269    0.7012    3.8586    0.7564    0.9826
    0.0000    0.7879    3.1518    0.8590    0.5512
         0   -0.1080   -0.4319   -0.5734   -0.4660
         0   -0.2911   -1.1645   -0.3501   -0.1242
>> % Now let A(2,2) be the pivot.
>> c = -A(3,2)/A(2,2); A(3,:) = A(3,:) + c*A(2,:);
>> c = -A(4,2)/A(2,2); A(4,:) = A(4,:) + c*A(2,:);
A =
    0.5269    0.7012    3.8586    0.7564    0.9826
    0.0000    0.7879    3.1518    0.8590    0.5512
    0.0000         0    0.0000   -0.4556   -0.3905
    0.0000         0         0   -0.0327    0.0795
>> % Now choose A(3,4) as the pivot.
>> c = -A(4,4)/A(3,4); A(4,:) = A(4,:) + c*A(3,:);
A =
    0.5269    0.7012    3.8586    0.7564    0.9826
    0.0000    0.7879    3.1518    0.8590    0.5512
    0.0000         0    0.0000   -0.4556   -0.3905
    0.0000         0    0.0000         0    0.1075
    
```

It is worth noticing that we have introduced some small round-off error. For example:

```

>> A(2,1)
ans =
    1.3878e-17
    
```

This is not exactly zero. However, up to the 14 significant digits that MATLAB can print out, the matrix we have above is in row echelon form.

2. (a)

```

>> a = zeros(5);
>> a(1,[2 4]) = [1 1];
>> a(2,[1 3 4]) = [1 1 1];
>> a(3,[2 5]) = [1 1];
>> a(4,[1 2]) = [1 1];
>> a(5,3) = 1
a =
     0     1     0     1     0
     1     0     1     1     0
     0     1     0     0     1
     1     1     0     0     0
     0     0     1     0     0
    
```

(b) A will have 5 rows, since there are 5 nodes, and 8 columns, since there are 8 edges.

```

>> A = zeros(5,8);
>> A([1 2], 1) = [-1; 1] ;
>> A([2 4], 2) = [-1; 1] ;
>> A([4 1], 3) = [-1; 1] ;
>> A([1 3], 4) = [-1; 1] ;
>> A([3 5], 5) = [-1; 1] ;
>> A([5 1], 6) = [-1; 1] ;
>> A([3 4], 7) = [-1; 1] ;
>> A([5 4], 8) = [-1; 1]
    
```

```
A =
-1    0    1   -1    0    1    0    0
 1   -1    0    0    0    0    0    0
 0    0    0    1   -1    0   -1    0
 0    1   -1    0    0    0    1    1
 0    0    0    0    1   -1    0   -1
```

3. (a)

```
>> A = [ 1 2 3; 4 5 6]; %2 x 3
>> B = [ 1 2; 3 4; 5 6]; %3 x 2
>> A + B
??? Error using ==> +
Matrix dimensions must agree.
```

(b) In general, if A and B are the same size,

$$sA + sB = s(A + B).$$

We can check this on random matrices as follows:

```
>> A = rand(3)
A =
 0.9866    0.0907    0.5007
 0.4940    0.9478    0.3841
 0.2661    0.0737    0.2771
>> B = rand(3)
B =
 0.9138    0.9410    0.7702
 0.5297    0.0501    0.8278
 0.4644    0.7615    0.1254
>> s = rand(1)
s =
 0.0159
>> C = s*A + s*B
C =
 0.0302    0.0164    0.0202
 0.0162    0.0158    0.0192
 0.0116    0.0133    0.0064
>> D = s*(A+B)
D =
 0.0302    0.0164    0.0202
 0.0162    0.0158    0.0192
 0.0116    0.0133    0.0064
>> C - D
ans =
 1.0e-17 *
 0.3469     0     0
 0         0     0
 0         0     0
```

We see that $C - D$ is not exactly zero, but the difference between C and D can be accounted for by round off error in the computer. This process can be repeated with any matrices A and B , and the same results will occur.

Section 1.6

1. $2 \cdot 3 + 3 \cdot 0 + (-5) \cdot 4 = -14$ 2. $1 \cdot 3 + 2 \cdot (-7) + (-1) \cdot 4 + 0 \cdot (-2) = -15$

3. $5 \cdot 3 + 7 \cdot (-2) = 1$ 4. $8 \cdot 7 + 3 \cdot (-4) + 1 \cdot 3 = 47$ 5. $ac + bd$

6. $xy + yz + zx$ 7. $(-1)^2 + (-3)^2 + 4^2 + 5^2 = 51$

8. Since $a_i^2 \geq 0$ then $\mathbf{a} \cdot \mathbf{a} = a_1^2 + a_2^2 + \cdots + a_n^2 \geq 0$

9. If $\mathbf{a} = 0$, then $\mathbf{a} \cdot \mathbf{a} = 0$. Conversely, if $\mathbf{a} \neq 0$, then $a_i^2 > 0$ for some i , and hence $\mathbf{a} \cdot \mathbf{a} > 0$. Thus, $\mathbf{a} = 0$ if and only if $\mathbf{a} \cdot \mathbf{a} = 0$.

10. $2 \cdot 0 + (-4) \cdot (-9) + 8 \cdot (-21) = -132$ 11. $\mathbf{a} \cdot \begin{pmatrix} 4 \\ -4 \\ -2 \end{pmatrix} = 4 + 8 - 8 = 4$

12. $\mathbf{c} \cdot \begin{pmatrix} 1 \\ 1 \\ 11 \end{pmatrix} = 4 - 1 + 55 = 58$ 13. $\begin{pmatrix} 0 \\ -6 \\ -14 \end{pmatrix} \cdot \left(\begin{pmatrix} 12 \\ -3 \\ 15 \end{pmatrix} - \begin{pmatrix} 5 \\ -10 \\ 20 \end{pmatrix} \right) = 0 - 42 + 70 = 28$

14. $\begin{pmatrix} -3 \\ -1 \\ -1 \end{pmatrix} \cdot \left(\begin{pmatrix} 0 \\ -9 \\ -21 \end{pmatrix} - \begin{pmatrix} 4 \\ -8 \\ 16 \end{pmatrix} \right) = 12 + 1 + 37 = 50$

15. $\begin{pmatrix} 8+0 & 2+18 \\ -4+0 & -1+12 \end{pmatrix} = \begin{pmatrix} 8 & 20 \\ -4 & 11 \end{pmatrix}$ 16. $\begin{pmatrix} -15-2 & 18-6 \\ -5+4 & 6+12 \end{pmatrix} = \begin{pmatrix} -17 & 12 \\ -1 & 18 \end{pmatrix}$

17. $\begin{pmatrix} -1-2 & 0-3 \\ -1+2 & 0+3 \end{pmatrix} = \begin{pmatrix} -3 & -3 \\ 1 & 3 \end{pmatrix}$ 18. $\begin{pmatrix} -15+6 & 10+24 \\ 3+3 & -2+12 \end{pmatrix} = \begin{pmatrix} -9 & 34 \\ 6 & 10 \end{pmatrix}$

19. $\begin{pmatrix} -12+25+0 & 4+30+1 & -4+20+2 \\ 0+20+0 & 0+24+2 & 0+16+4 \end{pmatrix} = \begin{pmatrix} 13 & 35 & 18 \\ 20 & 26 & 20 \end{pmatrix}$

20. $\begin{pmatrix} 7+0-8 & 42+4+12 \\ 2+0-10 & 12-12+15 \end{pmatrix} = \begin{pmatrix} -1 & 58 \\ -8 & 15 \end{pmatrix}$

21. $\begin{pmatrix} 7+12 & 1-18 & 4+30 \\ 0+8 & 0-12 & 0+20 \\ -14+6 & -2-9 & -8+15 \end{pmatrix} = \begin{pmatrix} 19 & -17 & 34 \\ 8 & -12 & 20 \\ -8 & -11 & 7 \end{pmatrix}$ 22. not defined

23. $\begin{pmatrix} 2+4+12 & -3+0+18 & 5+24+6 \\ -4+3+10 & 6+0+15 & -10+18+5 \\ 2+0+8 & -3+0+12 & 5+0+4 \end{pmatrix} = \begin{pmatrix} 18 & 15 & 35 \\ 9 & 21 & 13 \\ 10 & 9 & 9 \end{pmatrix}$

$$24. \begin{pmatrix} 2+6+5 & 8-9+0 & 12-15+20 \\ 1+0+6 & 4+0+0 & 6+0+24 \\ 2-6+1 & 8+9+0 & 12+15+4 \end{pmatrix} = \begin{pmatrix} 13 & -1 & 17 \\ 7 & 4 & 30 \\ -3 & 17 & 31 \end{pmatrix}$$

$$25. (3+8+0-4 \quad -6+16+0+6) = (7 \ 16)$$

$$26. \begin{pmatrix} 3+8+0-4 \\ -6+16+0+6 \end{pmatrix} = \begin{pmatrix} 7 \\ 16 \end{pmatrix} \quad 27. \begin{pmatrix} 3 & -2 & 1 \\ 4 & 0 & 6 \\ 5 & 1 & 9 \end{pmatrix} \quad 28. \begin{pmatrix} 3 & -2 & 1 \\ 4 & 0 & 6 \\ 5 & 1 & 9 \end{pmatrix}$$

$$29. \begin{pmatrix} a \cdot 1 + b \cdot 0 + c \cdot 0 & a \cdot 0 + b \cdot 1 + c \cdot 0 & a \cdot 0 + b \cdot 0 + c \cdot 1 \\ d \cdot 1 + e \cdot 0 + f \cdot 0 & d \cdot 0 + e \cdot 1 + f \cdot 0 & d \cdot 0 + e \cdot 0 + f \cdot 1 \\ g \cdot 1 + h \cdot 0 + i \cdot 0 & g \cdot 0 + h \cdot 1 + i \cdot 0 & g \cdot 0 + h \cdot 0 + i \cdot 1 \end{pmatrix} = \begin{pmatrix} a & b & c \\ d & e & f \\ g & h & i \end{pmatrix}$$

30. We want $\begin{pmatrix} 2a+b & 3a+2b \\ 2c+d & 3c+2d \end{pmatrix} = \begin{pmatrix} 1 & 0 \\ 0 & 1 \end{pmatrix}$. This gives two systems of equations:

$$\begin{array}{l} 2a+b=1 \quad 2c+d=0 \\ 3a+2b=0 \quad 3c+2d=1 \end{array} \text{ Solving for } a \text{ and } b \text{ we find } \left(\begin{array}{cc|c} 2 & 1 & 1 \\ 3 & 2 & 0 \end{array} \right) \rightarrow \left(\begin{array}{cc|c} 1 & 1/2 & 1/2 \\ 0 & 1/2 & -3/2 \end{array} \right) \\ \rightarrow \left(\begin{array}{cc|c} 1 & 0 & 2 \\ 0 & 1 & -3 \end{array} \right). \text{ Hence, } a=2 \text{ and } b=-3. \text{ Similarly, one can show } c=-1 \text{ and } d=2.$$

31. We want $\begin{pmatrix} a_{11}b_{11} + a_{12}b_{12} & a_{11}b_{12} + a_{12}b_{22} \\ a_{21}b_{11} + a_{22}b_{21} & a_{21}b_{12} + a_{22}b_{22} \end{pmatrix} = \begin{pmatrix} 1 & 0 \\ 0 & 1 \end{pmatrix}$. As in problem 30, this gives two systems of equations:

$$\begin{array}{ll} a_{11}b_{11} + a_{12}b_{21} = 1 & a_{11}b_{12} + a_{12}b_{22} = 0 \\ a_{21}b_{11} + a_{22}b_{21} = 0 & a_{21}b_{12} + a_{22}b_{22} = 1 \end{array}$$

Since $a_{11}a_{22} - a_{12}a_{21} \neq 0$, then either a_{11} or a_{21} is nonzero. Without loss of generality, we may assume

$$a_{11} \neq 0. \text{ Solving for } b_{11} \text{ and } b_{21} \text{ we obtain } \left(\begin{array}{cc|c} a_{11} & a_{12} & 1 \\ a_{21} & a_{22} & 0 \end{array} \right) \rightarrow \left(\begin{array}{cc|c} 1 & a_{12}/a_{11} & 1/a_{11} \\ 0 & a_{22} - a_{21}a_{12}/a_{11} & -a_{21}/a_{11} \end{array} \right).$$

Solving for b_{21} gives $b_{21} = -a_{21}/(a_{11}a_{22} - a_{21}a_{12})$. Use back substitution to find $b_{11} = a_{22}/(a_{11}a_{22} - a_{21}a_{12})$. Similarly, solving the second set of equations for b_{12} , b_{22} , gives $b_{12} = -a_{12}/(a_{11}a_{22} - a_{21}a_{12})$, and $b_{22} = a_{11}/(a_{11}a_{22} - a_{21}a_{12})$.

$$32. A(BC) = A \cdot \begin{pmatrix} 1 & 11 \\ 4 & 18 \\ 7 & 10 \end{pmatrix} = \begin{pmatrix} 26 & 44 \\ 43 & 71 \end{pmatrix} \quad (AB)C = \begin{pmatrix} 12 & -7 & 0 \\ 19 & -12 & 1 \end{pmatrix} \cdot C = \begin{pmatrix} 26 & 44 \\ 43 & 71 \end{pmatrix}$$

33. (a) There are 3 people in group 1, 4 in group 2, and 5 in group 3.

$$(b) AB = \begin{pmatrix} 2 & 1 & 1 & 0 & 0 \\ 1 & 1 & 0 & 1 & 0 \\ 1 & 0 & 2 & 0 & 1 \end{pmatrix}$$

34. (a) There are 2 people in group 1, 5 in group 2, and 7 in group 3.

$$(b) AB = \begin{pmatrix} 2 & 1 & 0 & 1 & 2 & 1 & 3 \\ 0 & 2 & 0 & 2 & 1 & 0 & 1 \end{pmatrix}$$

35. $\mathbf{a} \cdot \mathbf{b} = 2 \cdot 3 + (-3) \cdot 2 = 0$ orthogonal

36. $\mathbf{a} \cdot \mathbf{b} = 2 \cdot (-3) + (-3) \cdot 2 = -12 \neq 0$ not orthogonal.

37. $\mathbf{a} \cdot \mathbf{b} = 1 \cdot 2 + 4 \cdot 3 + (-7) \cdot 2 = 0$ orthogonal.

38. $\mathbf{a} \cdot \mathbf{b} = 1 \cdot 0 + 0 \cdot 1 + 1 \cdot 0 + 0 \cdot 1 = 0$ orthogonal.

39. $\mathbf{a} \cdot \mathbf{b} = a \cdot 0 + 0 \cdot d + b \cdot 0 + 0 \cdot e + c \cdot 0 = 0$ orthogonal.

40. We want $(1, -2, 3, 5) \cdot (-4, \alpha, 6, -1) = -4 - 2\alpha + 18 - 5 = 0$. Hence, $\alpha = 9/2$.

$$41. \text{ We want } \begin{pmatrix} 1 \\ -\alpha \\ 2 \\ 3 \end{pmatrix} \cdot \begin{pmatrix} 4 \\ 5 \\ -2\beta \\ 7 \end{pmatrix} = 4 - 5\alpha - 4\beta + 21 = 0. \text{ Let } \beta \text{ be arbitrary. Then } \alpha = 5 - \frac{4}{5}\beta.$$

42. (i) $\mathbf{a} \cdot \mathbf{0} = a_1 \cdot 0 + a_2 \cdot 0 + \cdots + a_n \cdot 0 = 0$ (ii) in text

$$\begin{aligned} \text{(iii) } \mathbf{a} \cdot (\mathbf{b} + \mathbf{c}) &= \mathbf{a} \cdot (b_1 + c_1, b_2 + c_2, \dots, b_n + c_n) \\ &= a_1(b_1 + c_1) + a_2(b_2 + c_2) + \cdots + a_n(b_n + c_n) \\ &= a_1b_1 + a_2b_2 + \cdots + a_nb_n + a_1c_1 + a_2c_2 + \cdots + a_nc_n \\ &= \mathbf{a} \cdot \mathbf{b} + \mathbf{a} \cdot \mathbf{c} \end{aligned}$$

$$\begin{aligned} \text{(iv) } (\alpha \mathbf{a}) \cdot \mathbf{b} &= (\alpha a_1, \alpha a_2, \dots, \alpha a_n) \cdot \mathbf{b} \\ &= \alpha a_1 b_1 + \alpha a_2 b_2 + \cdots + \alpha a_n b_n \\ &= \alpha (a_1 b_1 + a_2 b_2 + \cdots + a_n b_n) \\ &= \alpha (\mathbf{a} \cdot \mathbf{b}) \end{aligned}$$

$$43. (a) (2, 3, 5, 1) \quad (b) \begin{pmatrix} 1 \\ 1.5 \\ 0.5 \\ 2 \end{pmatrix} \quad (c) \text{ total hours} = 2 + 4.5 + 2.5 + 2 = 11$$

$$44. (a) (1000, 20, 100, 5000, 50) \quad (b) \begin{pmatrix} 0.055 \\ 1.80 \\ 0.20 \\ 0.001 \\ 0.40 \end{pmatrix} \quad (c) \$136.00$$

45. (a) $\begin{pmatrix} 80,000 & 45,000 & 40,000 \\ & 50 & 20 & 10 \end{pmatrix}$ (b) $\begin{pmatrix} 1 \\ 3 \\ 1 \end{pmatrix}$ (c) $\begin{pmatrix} 255,000 \\ 120 \end{pmatrix}$

46. Express the sales of each item in each month as the 4×3 matrix $A = \begin{pmatrix} 4 & 2 & 20 \\ 6 & 1 & 9 \\ 5 & 3 & 12 \\ 8 & 2.5 & 20 \end{pmatrix}$. Express the unit

profit and unit taxes as the 3×2 matrix $B = \begin{pmatrix} 3.5 & 1.5 \\ 2.75 & 2 \\ 1.5 & 0.6 \end{pmatrix}$. Then $AB = \begin{pmatrix} 49.5 & 22 \\ 37.25 & 16.4 \\ 43.75 & 20.7 \\ 64.875 & 29 \end{pmatrix}$ shows the total profits and taxes in each of the four months.

47. $\begin{pmatrix} 4-4 & -2-6 \\ 8+24 & -4+36 \end{pmatrix} = \begin{pmatrix} 0 & -8 \\ 32 & 32 \end{pmatrix}$ 48. $\begin{pmatrix} 1 & 2 & 18 \\ 5 & -1 & 23 \\ 8 & 3 & 32 \end{pmatrix}$

49. $A^2 = \begin{pmatrix} 7 & 6 \\ 9 & 22 \end{pmatrix}$ $A^3 = AA^2 = \begin{pmatrix} -1 & 2 \\ 3 & 4 \end{pmatrix} \begin{pmatrix} 7 & 6 \\ 9 & 22 \end{pmatrix} = \begin{pmatrix} 11 & 38 \\ 57 & 106 \end{pmatrix}$

50. $A^2 = \begin{pmatrix} 0 & 0 & 1 & 0 \\ 0 & 0 & 0 & 1 \\ 0 & 0 & 0 & 0 \\ 0 & 0 & 0 & 0 \end{pmatrix}$ $A^3 = \begin{pmatrix} 0 & 0 & 0 & 1 \\ 0 & 0 & 0 & 0 \\ 0 & 0 & 0 & 0 \\ 0 & 0 & 0 & 0 \end{pmatrix}$ $A^4 = A^5 = 0$

51. $A^2 = \begin{pmatrix} 0 & 0 & 1 & 0 & 0 \\ 0 & 0 & 0 & 1 & 0 \\ 0 & 0 & 0 & 0 & 1 \\ 0 & 0 & 0 & 0 & 0 \\ 0 & 0 & 0 & 0 & 0 \end{pmatrix}$ $A^3 = \begin{pmatrix} 0 & 0 & 0 & 1 & 0 \\ 0 & 0 & 0 & 0 & 1 \\ 0 & 0 & 0 & 0 & 0 \\ 0 & 0 & 0 & 0 & 0 \\ 0 & 0 & 0 & 0 & 0 \end{pmatrix}$ $A^4 = \begin{pmatrix} 0 & 0 & 0 & 0 & 1 \\ 0 & 0 & 0 & 0 & 0 \\ 0 & 0 & 0 & 0 & 0 \\ 0 & 0 & 0 & 0 & 0 \\ 0 & 0 & 0 & 0 & 0 \end{pmatrix}$ $A^5 = 0$

52. Let a_{ij} be an element of A . Let B be an $n \times n$ matrix with $b_{j1} = 1$ and 0's everywhere else. Let $AB = C$. $C = 0$ implies $c_{i1} = a_{ij} = 0$. Since a_{ij} was arbitrary, then A is the zero matrix.

53. $PQ = \begin{pmatrix} \frac{11}{90} & \frac{41}{90} & \frac{19}{45} \\ \frac{11}{120} & \frac{71}{120} & \frac{19}{60} \\ \frac{1}{5} & \frac{1}{5} & \frac{3}{5} \end{pmatrix}$. Each component is ≥ 0 and the sum of the elements in each row is 1.

54. Clearly, the elements of P^2 are positive. If P is $n \times n$, let \mathbf{v} be a column n -vector with 1 as its elements. Note that if A is an $n \times n$ matrix, then the sum of the elements in each row of A is 1 if and only if $A\mathbf{v} = \mathbf{v}$. We have $P^2\mathbf{v} = P(P\mathbf{v}) = P\mathbf{v} = \mathbf{v}$. Hence, P^2 is a probability matrix.

55. Since every entry of P and of Q is positive, the entries of PQ are all positive. If p and Q are $n \times n$ matrices, let \mathbf{v} be the column n -vector with every element 1; note that if A is an $n \times n$ matrix, the sum of its entries along any row is 1 if and only if $A\mathbf{v} = \mathbf{v}$. Since $(PQ)\mathbf{v} = P(Q\mathbf{v}) = P\mathbf{v} = \mathbf{v}$, we see that PQ is a probability matrix.

$$56. ABCD = AB(CD) = A(B(CD)) = A(BC)D = (AB)CD = ((AB)C)D = (AB)(CD)$$

$$57. R^2 = \begin{pmatrix} 0 & 0 & 1 & 1 \\ 2 & 0 & 1 & 0 \\ 0 & 1 & 0 & 0 \\ 1 & 1 & 0 & 0 \end{pmatrix} \quad S_1 = 1 + \frac{1}{2}(1 + 1) = 2 \quad S_2 = 1 + 1 + \frac{1}{2}(2 + 1) = 3.5 \\ S_3 = 1 + \frac{1}{2}(1) = 1.5 \quad S_4 = 1 + 1 + \frac{1}{2}(1 + 1) = 3$$

(a) $S_2 > S_4 > S_1 > S_3$ (b) The score is the number of games won by player i plus half the number of games won by players who player i beat.

58. $OA = O_1$. The ij^{th} component of OA , c_{ij} , can be written $c_{ij} = \sum_{k=1}^n o_{ik} a_{kj}$. Since each element of O is 0, then $c_{ij} = 0$. Hence, O_1 is the $m \times p$ zero matrix.

$$59. A(B + C) = A \cdot \begin{pmatrix} 1 & 9 \\ 2 & 11 \\ 10 & 1 \end{pmatrix} = \begin{pmatrix} 45 & 35 \\ 1 & 16 \end{pmatrix} = AB + AC = \begin{pmatrix} 24 & 15 \\ 7 & 17 \end{pmatrix} + \begin{pmatrix} 21 & 20 \\ -6 & -1 \end{pmatrix}$$

$$60. \left(\begin{array}{cc|cc} 2 & 3 & 1 & 5 \\ 0 & 1 & -4 & 2 \\ \hline 3 & 1 & 6 & 4 \end{array} \right) \left(\begin{array}{c} 1 & 4 \\ -1 & 0 \\ \hline 2 & 3 \\ 1 & 5 \end{array} \right) = \left(\begin{array}{cc|cc} (2 \ 3) & (1 \ 4) & & \\ (0 \ 1) & (-1 \ 0) & & \\ \hline (3 \ 1) & (1 \ 4) & (1 \ 5) & (2 \ 3) \\ & (-1 \ 0) & (6 \ 4) & (1 \ 5) \end{array} \right) \\ = \left(\begin{array}{cc|cc} (-1 \ 8) & (7 \ 28) & & \\ (-1 \ 0) & (-6 \ -2) & & \\ \hline (2 \ 12) & (16 \ 38) & & \end{array} \right) = \begin{pmatrix} 6 & 36 \\ -7 & -2 \\ 18 & 50 \end{pmatrix}$$

$$61. \left(\begin{array}{c} 1 \\ 6 \\ 2 \end{array} \right) (3 \mid 7 \mid 1 \mid 5) = \left(\begin{array}{c|c|c|c} 3 & 7 & 1 & 5 \\ \hline 18 & 42 & 6 & 30 \\ \hline 6 & 14 & 2 & 10 \end{array} \right).$$

$$62. \left(\begin{array}{cc|cc} 1 & 0 & -1 & 1 \\ 2 & 1 & -3 & 4 \\ -2 & 1 & 4 & 6 \\ \hline 0 & 2 & 3 & 5 \end{array} \right) \left(\begin{array}{cc|cc} 2 & 4 & 1 & 6 \\ 3 & 0 & -2 & 5 \\ \hline 2 & 1 & -1 & 0 \\ -2 & -4 & 1 & 3 \end{array} \right) \\ = \left(\begin{array}{cc|cc} (1 \ 0) & (2 \ 4) & & \\ (2 \ 1) & (3 \ 0) & & \\ \hline (-2 \ 1) & (2 \ 4) & (1 \ 6) & (2 \ 3) \\ (0 \ 2) & (3 \ 0) & (-2 \ 5) & (-1 \ 0) \end{array} \right) \\ = \left(\begin{array}{cc|cc} (2 \ 4) & (-4 \ -5) & & \\ (7 \ 8) & (-14 \ -19) & & \\ \hline (-1 \ -8) & (-4 \ -20) & (1 \ 6) & (2 \ 3) \\ (6 \ 0) & (-4 \ -17) & (0 \ 17) & (7 \ 12) \end{array} \right) \\ = \left(\begin{array}{cc|cc} (-2 \ -1) & (3 \ 9) & & \\ (-7 \ -11) & (7 \ 29) & & \\ -5 & -28 & -2 & 11 \\ \hline 2 & -17 & -2 & 25 \end{array} \right).$$

$$\begin{aligned}
63. & \left(\begin{array}{cc|cc} 1 & 0 & 0 & 0 \\ 0 & 1 & 0 & 0 \\ \hline 0 & 0 & a & b \\ 0 & 0 & c & d \end{array} \right) \left(\begin{array}{cc|cc} e & f & 0 & 0 \\ g & h & 0 & 0 \\ \hline 0 & 0 & 1 & 0 \\ 0 & 0 & 0 & 1 \end{array} \right) \\
& = \left(\begin{array}{cc|cc} \left(\begin{array}{cc} 1 & 0 \\ 0 & 1 \end{array} \right) \left(\begin{array}{cc} e & f \\ g & h \end{array} \right) + \left(\begin{array}{cc} 0 & 0 \\ 0 & 0 \end{array} \right) \left(\begin{array}{cc} 0 & 0 \\ 0 & 0 \end{array} \right) & \left(\begin{array}{cc} 1 & 0 \\ 0 & 1 \end{array} \right) \left(\begin{array}{cc} 0 & 0 \\ 0 & 0 \end{array} \right) + \left(\begin{array}{cc} 0 & 0 \\ 0 & 0 \end{array} \right) \left(\begin{array}{cc} 1 & 0 \\ 0 & 1 \end{array} \right) \\ \hline \left(\begin{array}{cc} 0 & 0 \\ 0 & 0 \end{array} \right) \left(\begin{array}{cc} e & f \\ g & h \end{array} \right) + \left(\begin{array}{cc} a & b \\ c & d \end{array} \right) \left(\begin{array}{cc} 0 & 0 \\ 0 & 0 \end{array} \right) & \left(\begin{array}{cc} 0 & 0 \\ 0 & 0 \end{array} \right) \left(\begin{array}{cc} 0 & 0 \\ 0 & 0 \end{array} \right) + \left(\begin{array}{cc} a & b \\ c & d \end{array} \right) \left(\begin{array}{cc} 1 & 0 \\ 0 & 1 \end{array} \right) \end{array} \right) \\
& = \left(\begin{array}{cc|cc} e & f & 0 & 0 \\ g & h & 0 & 0 \\ \hline 0 & 0 & a & b \\ 0 & 0 & c & d \end{array} \right)
\end{aligned}$$

$$64. \left(\frac{I_2 \begin{pmatrix} -1 & 1 & 4 \\ 0 & 4 & -3 \end{pmatrix} + \begin{pmatrix} 2 & 3 & 1 \\ 5 & 2 & 6 \end{pmatrix} I_3}{0 \begin{pmatrix} -1 & 1 & 4 \\ 0 & 4 & -3 \end{pmatrix} + \begin{pmatrix} -1 & 2 & 4 \\ 2 & 1 & 3 \end{pmatrix} I_3} \right) = \begin{pmatrix} 1 & 4 & 5 \\ 5 & 6 & 3 \\ -1 & 2 & 4 \\ 2 & 1 & 3 \end{pmatrix}$$

$$\begin{aligned}
65. \quad AB &= \begin{pmatrix} I & O \\ C & I \end{pmatrix} \begin{pmatrix} I & O \\ D & I \end{pmatrix} = \begin{pmatrix} I^2 + OD & I \cdot O + O \cdot I \\ CI + ID & C \cdot O + I^2 \end{pmatrix} = \begin{pmatrix} I^2 & O \\ C + D & I^2 \end{pmatrix} \\
BA &= \begin{pmatrix} I & O \\ D & I \end{pmatrix} \begin{pmatrix} I & O \\ C & I \end{pmatrix} = \begin{pmatrix} I^2 + OC & I \cdot O + O \cdot I \\ DI + IC & D \cdot O + I^2 \end{pmatrix} \\
&= \begin{pmatrix} I^2 & O \\ D + C & I^2 \end{pmatrix} = \begin{pmatrix} I^2 & O \\ C + D & I^2 \end{pmatrix} = AB.
\end{aligned}$$

$$66. \sum_{i=1}^3 (i + 2i + 3i + 4i) = 10 \sum_{i=1}^3 i = 60 \qquad 67. \sum_{k=1}^3 99k^2 = 1,386$$

$$68. 2^0 + 2^1 + 2^2 + 2^3 + 2^4 = \sum_{k=0}^4 2^k$$

$$69. (-3)^0 + (-3)^1 + (-3)^2 + (-3)^3 + (-3)^4 + (-3)^5 = \sum_{i=0}^5 (-3)^i$$

$$70. \sum_{k=2}^n k/(k+1) \qquad 71. \sum_{i=1}^n i^{1/i}$$

$$72. \sum_{i=1}^3 (i + 2i + 3i + 4i) = 10 \sum_{i=1}^3 i = 60 \qquad 73. \sum_{k=1}^3 99k^2 = 1,386$$

$$74. 2^0 + 2^1 + 2^2 + 2^3 + 2^4 = \sum_{k=0}^4 2^k$$

$$75. (-3)^0 + (-3)^1 + (-3)^2 + (-3)^3 + (-3)^4 + (-3)^5 = \sum_{i=0}^5 (-3)^i$$

$$76. \sum_{k=2}^n k/(k+1) \\ 64 = 99.$$

$$77. \sum_{i=1}^n i^{1/i}$$

$$78. \sum_{k=0}^7 x^{3k}$$

$$79. \sum_{i=0}^9 (-1)^{i+1} a^{-i} \text{ as } \sum_{j=2}^4 j^3 = 8 + 27 +$$

$$80. (2 \cdot 1 - 1)(2 \cdot 1 + 1) + \cdots + (2 \cdot 8 - 1)(2 \cdot 8 + 1) = \sum_{k=1}^8 (2k - 1)(2k + 1)$$

$$81. 2^2(2 \cdot 2) + 3^2(2 \cdot 3) + \cdots + 7^2(2 \cdot 7) = \sum_{k=2}^7 k^2(2k) = \sum_{k=2}^7 2k^3$$

$$82. \sum_{j=1}^3 (a_{1j} + a_{2j}) = \sum_{i=1}^7 \sum_{j=1}^3 a_{ij}$$

$$83. \sum_{j=1}^2 (a_{1j} + a_{2j} + a_{3j}) = \sum_{i=1}^3 \sum_{j=1}^2 a_{ij}$$

$$84. \sum_{j=1}^4 (a_{2j} + a_{3j} + a_{4j}) = \sum_{i=2}^4 \sum_{j=1}^4 a_{ij}$$

$$85. \sum_{i=1}^5 a_{3i} b_{i2}$$

$$86. \sum_{j=1}^4 (a_{21} b_{1j} c_{j5} + a_{22} b_{2j} c_{j5} + a_{23} b_{3j} c_{j5}) = \sum_{i=1}^3 \sum_{j=1}^4 a_{2i} b_{ij} c_{j5}$$

$$87. \sum_{k=M}^N (a_k + b_k) = a_M + b_M + a_{M+1} + b_{M+1} + \cdots + a_N + b_N$$

$$= a_M + a_{M+1} + \cdots + a_N + b_M + b_{M+1} + \cdots + b_N$$

$$= \sum_{k=M}^N a_k = \sum_{k=M}^N b_k$$

$$88. \sum_{k=M}^N (a_k - b_k) = \sum_{k=M}^N (a_k + (-1)b_k) \stackrel{(14)}{=} \sum_{k=M}^N a_k + \sum_{k=M}^N (-1)b_k \stackrel{(13)}{=} \sum_{k=M}^N a_k - \sum_{k=M}^N b_k$$

$$89. \sum_{k=M}^N a_k = a_M + a_{M+1} + \cdots + a_N$$

$$= a_M + a_{M+1} + \cdots + a_{m-1} + a_m + a_{m+1} + \cdots + a_N$$

$$= \sum_{k=M}^m a_k + \sum_{k=m+1}^N a_k$$

CALCULATOR SOLUTIONS 1.6

In this section many of the problems have two input matrices, and we append the problem number to the matrix name; for instance we use $A16nn$ and $B16nn$ to refer to the left and right factors in the products in problem nn , $nn=90,91,92$. We assume that the matrices have been entered and we will only show how to obtain the solutions from these input matrices.

90. $A1690$ $B1690$ gives the product:

$$\begin{bmatrix} -12.0704 & -26.8412 \\ 44.4207 & -45.0695 \\ 91.7485 & 4.2242 \end{bmatrix}$$

91. $A1691$ $B1691$ gives the product:

$$\begin{bmatrix} 34192 & 38621 \\ 50408 & 44115 \\ 62661 & 71731 \\ 59190 & 55046 \end{bmatrix}$$

92. $A1692$ $B1692$ gives the product:

$$\begin{bmatrix} -.6557 & -3.3655 \\ .6907 & 3.4072 \\ -1.4255 & 5.5459 \end{bmatrix}$$

93. (a) To see $P1693$ and $Q1693$ are probability matrices compute their row sums by computing their products with

the column of all ones: $[[1][1][1][1]]$ ONES

$$P1693 \text{ ONES : \begin{bmatrix} [1] \\ [1] \\ [1] \\ [1] \end{bmatrix} \text{ and } Q1693 \text{ ONES : \begin{bmatrix} [1] \\ [1] \\ [1] \\ [1] \end{bmatrix} .$$

(b)

The product $P1693$ $Q1693$:

$$\begin{bmatrix} .31118 & .18444 & .14174 & .36264 \\ .32625 & .27585 & .08454 & .31336 \\ .17955 & .22651 & .19619 & .39775 \\ .30047 & .15251 & .33558 & .21144 \end{bmatrix}$$

can be saved as $PQ1693$ via $PQ1693$. Then you see the product is a probability matrix

by showing its row sums are all 1 by $PQ1693$ ONES which yields:

$$\begin{bmatrix} [1] \\ [1] \\ [1] \\ [1] \end{bmatrix}$$

94. Entering $A1694$ n , $n = 2, 5, 10, 50, 100$ gives:

$A1694^2$	$A1694^5$	$A1694^{10}$	$A1694^{50}$	$A1694^{100}$
is	is	is	is	is
$\begin{bmatrix} [1] & 9 \\ [0] & 4 \end{bmatrix}$	$\begin{bmatrix} [1] & 93 \\ [0] & 32 \end{bmatrix}$	$\begin{bmatrix} [1] & 3069 \\ [0] & 1024 \end{bmatrix}$	$\begin{bmatrix} [1] & 3.378E15 \\ [0] & 1.126E15 \end{bmatrix}$	$\begin{bmatrix} [1] & 3.803E30 \\ [0] & 1.268E30 \end{bmatrix}$

95. From the A^2 , A^5 , A^{10} results in Problem 94, where the diagonal components are $\{1^2, 2^2\}$, $\{1^5, 2^5\}$ and $\{1^{10}, 2^{10}\}$, it appears that the diagonal components of A^n are just a^n, b^n, c^n .

MATLAB 1.6

1.

```

>> A = rand(3,4)
A =
    0.6885    0.7362    0.8886    0.3510
    0.8682    0.7254    0.2332    0.5133
    0.6295    0.9995    0.3063    0.5911

>> B = rand(4,2)
B =
    0.8460    0.4154
    0.4121    0.5373
    0.8415    0.4679
    0.2693    0.2872

>> A*B
ans =
    1.7281    1.1982
    1.3679    1.0070
    1.3614    1.1116

>> B*A
??? Error using ==> *
Inner matrix dimensions must agree.

```

The product of a 3×4 with a 4×2 will be a 3×2 matrix, so AB is a 3×2 matrix. However, the product of a 4×2 with a 3×4 is not defined since 2, the number of columns of left factor, is not 3, the number of rows of the right factor.

2.

```

>> A = round(10*(2*rand(3)-1))
A =
   -9   -10   -2
    1    -2    4
    3    -9    2

>> B = round(10*(2*rand(3)-1))
B =
    9   -8    4
    7    3    8
    1   -2    5

>> A*B
ans =
  -153    46  -126
    -1   -22     8
   -34  -55   -50

>> B*A
ans =
  -77  -110   -42
  -36  -148    14
    4   -51     0

```

The probability that for two random matrices, $AB = BA$ is very small.

3. (a)

```

>> A = [ 2 9 -23 0
         0 4 -12 4
         7 5 -1 1
         7 8 -10 4 ];

>> b = [ 34; 24; 15; 33 ];
>> z = [ -2; 3; 1; 0];
>> x = [ -5; 10; 2; 2];
>> A*x    % This will be b.
ans =
    34
    24
    15
    33

>> A*z    % This will be zero.
ans =
     0
     0
     0
     0

```

(b) For any scalar s ,

$$A(x + sz) = Ax + sAz = Ax + 0 = Ax.$$

This can be tested by computing the following:

```

>>s = rand(1)
s =
    0.7529

>> A * (x+s*z) % This will be b
ans =
    34.0000
    24.0000
    15.0000
    33.0000

```

4.

```

>>% Generate Random matrices:
>> A = round( 10*( 2*rand(2,4)-1) )
A =
    -3     3     0     4
    -5     4     5     9

>> B = round( 10*( 2*rand(4,5)-1) )
B =
    -1     0    10     1    -5
     9     3    -7     0     3
    -4    -2     3     7     1
    -1     2    -3    -10     8

```

```

>> B(:,2) = B(:,3)
B =
   -1    10    10     1    -5
     9    -7    -7     0     3
    -4     3     3     7     1
    -1    -3    -3   -10     8

>> % part (b):
>> A*B
ans =
    26   -63   -63   -43    56
    12   -90   -90   -60   114

```

Since columns 2 and 3 were the same in B , they will also be the same in AB .

(c) The above can be repeated several times.

(d) Proof: Assume that the columns m and n are the same in B . This implies that $b_{im} = b_{in}$ for any i . If $C = AB$, what we wish to show is that $c_{jm} = c_{jn}$ for any j , i.e., that the m and n th columns of C are the same. To do this, we will write c_{jm} using \sum notation. Assume that the width of A is p , then:

$$c_{jm} = \sum_{i=1}^p a_{ji}b_{im} = \sum_{i=1}^p a_{ji}b_{in} = c_{jn}.$$

Which concludes the proof.

5.

```

>> A = round( 10*( 2*rand(5,6) - 1) )
A =
   -5    -1     4     4     0     5
     9     6    -1    -4    -8    -1
    -5   -10     2     5    -7   -10
     7    -7     5    -7     8     2
     4     4    10   -10     6     0

>> x = round( 10*( 2*rand(6,1) - 1) )
x =
   -9
     1
    -2
    -6
    -2
     3

>> A*x - ( x(1)*A(:,1) + x(2)*A(:,2) + x(3)*A(:,3) + ...
           x(4)*A(:,4) + x(5)*A(:,5) + x(6)*A(:,6) )
ans =
     0
     0
     0
     0
     0

```

This is essentially the same as expression (10) in the text. The expression inside the parentheses is the definition of matrix multiplication.

6. (a) We can write $AB = BA$ as $AB - BA = 0$. Then, with this choice of A and B ,

$$\begin{aligned} 0 &= AB - BA \\ &= \begin{pmatrix} ax_1 + bx_3 & ax_2 + bx_4 \\ cx_1 + dx_3 & cx_2 + dx_4 \end{pmatrix} - \begin{pmatrix} ax_1 + cx_2 & bx_1 + dx_2 \\ ax_3 + cx_4 & bx_3 + dx_4 \end{pmatrix} \\ &= \begin{pmatrix} & -cx_2 + bx_3 & -bx_1 + (a-d)x_2 + bx_4 \\ cx_1 + (d-a)x_3 - cx_4 & & cx_2 - bx_3 \end{pmatrix} \end{aligned}$$

If we use each of the 4 entries in this matrix as one equation in our system, we will get a 4×4 system with coefficient matrix R and variables \mathbf{x} .

(b) (i)

```
>> a = 1; b = -1; c = 5; d = -4;
>> R = [ 0   -c   b   0
        -b  a-d   0   b
         c   0  d-a  -c
         0   c  -b   0]
```

```
R =
     0     -5     -1     0
     1      5      0     -1
     5      0     -5     -5
     0      5      1      0
```

```
>> rref(R)
ans =
  1.0000         0  -1.0000  -1.0000
         0  1.0000  0.2000         0
         0         0         0         0
         0         0         0         0
```

So $x_1 = x_3 + x_4$, $x_2 = \frac{1}{5}x_3$ or $B = \begin{pmatrix} x_3 + x_4 & \frac{1}{5}x_3 \\ x_3 & x_4 \end{pmatrix} = x_3 \begin{pmatrix} 1 & 1/5 \\ 1 & 0 \end{pmatrix} + x_4 \begin{pmatrix} 1 & 0 \\ 0 & 1 \end{pmatrix}$. Notice

that the matrices $x_4 \begin{pmatrix} 1 & 0 \\ 0 & 1 \end{pmatrix} = x_4 I$ commute with all matrices, and so there will always be infinitely many solutions for *any* A .

(ii)

```
>> format rat % Use rat(rref(R), 's') in Matlab 3.5
>> rref(R)
ans =
     1         0         -1         -1
     0         1        1/5         0
     0         0         0         0
     0         0         0         0
```

If we choose $x_3 = 5$, and $x_4 = 1$ we will get $x_1 = 6$, and $x_2 = -1$. You may choose any other integers, as long as x_3 is divisible by 5.

(iii) The matrix B will be

```
>> B = [6 -1; 5 1]
B =
     6     -1
     5      1
```

```

>> A = [a b; c d]
A =
     1     -1
     5     -4

>> A*B - B*A
ans =
     0     0
     0     0

```

Since $AB - BA$ is zero, we have verified that $AB = BA$.

- (iv) This can be repeated for any other choice of x_3 and x_4 .
(c) We can repeat the above, using the new matrix A :

```

>> a = 1; b = 2; c = 3; d = 4;
>> R = [ 0  -c  b  0
        -b  a-d  0  b
         c   0  d-a  -c
         0   c  -b  0]

R =
     0    -3     2     0
    -2    -3     0     2
     3     0     3    -3
     0     3    -2     0

```

```

>> format rat % This gives rational numbers in the output, for Matlab 4.0.
>> rref(R) % Use rat(rref(R), 1'1) in Matlab 3.5.
ans =
     1     0     1    -1
     0     1    -2/3    0
     0     0     0     0
     0     0     0     0

```

As above, we may choose x_3 and x_4 arbitrarily and $B = x_3 \begin{bmatrix} -1 & \frac{2}{3} \\ 1 & 0 \end{bmatrix} + x_4 \begin{bmatrix} 1 & 0 \\ 0 & 1 \end{bmatrix}$. (Again $x_4 I$ are possible B 's.) If we choose $x_3 = 3$, and $x_4 = 1$ we will get $x_1 = -2$, and $x_2 = 2$. The matrix B will be

```

>> B = [-2 2; 3 1]
B =
    -2     2
     3     1

>> A = [a b; c d]
A =
     1     2
     3     4

>> A*B - B*A
ans =
     0     0
     0     0

```

Since $AB - BA$ is zero, we have verified that $AB = BA$. (d) The above may be repeated using any matrix for A . To avoid round off error, you should use an integer matrix.

7.

```

>> A = round( 10*( 2*rand(2,2) -1) )
A =
    -6     4
    -9     4

>> B = round( 10*( 2*rand(2,2) -1) )
B =
     9     0
    -2     7

>> C = (A+B)^2
C =
   -35    56
  -154    77

>> D = A^2 + 2*A*B + B^2
D =
   -43    48
  -192    85

>> C-D
ans =
     8     8
    38    -8

```

In general, it is not true that $C = D$. However, they will be equal when we use A and B from problem 6:

```

>> A = [1 -1; 5 -4];
>> B = [6 -1; 5 1];
>> C = (A+B)^2
C =
    29    -8
    40   -11

>> D = A^2 + 2*A*B + B^2
D =
    29    -8
    40   -11

>> C-D
ans =
     0     0
     0     0

```

When this is repeated with the matrices from 6(c), C will again be the same as D . In fact the statement

$$(A + B)^2 = A^2 + 2AB + B^2$$

if and only if

$$AB = BA.$$

Proof: We may expand $(A + B)^2$ as follows:

$$\begin{aligned}
 (A + B)^2 &= (A + B)(A + B) \\
 &= A(A + B) + B(A + B) \\
 &= AA + AB + BA + BB \\
 &= A^2 + AB + BA + B^2.
 \end{aligned}$$

If we subtract this from $A^2 + 2AB + B^2$, we get $AB - BA$, which is zero whenever $AB = BA$. Thus we may say that $(A + B)^2$ is $A^2 + 2AB + B^2$ exactly when AB is BA .

8. (a)

```
>> A = round( 10*(2*rand(6,5)-1))
```

```
A =
     4     3    -9    -3    -9
     2    -2     5    -5     3
     9     4    -3    10     8
     7     8     3     4    -5
     1     5     5     5    -1
    -8    -5    10     3     5
```

```
>> E = [1 0 0 0 0 0]
```

```
E =
     1     0     0     0     0     0
```

```
>> E*A
```

```
ans =
     4     3    -9    -3    -9
```

```
>> E = [0 0 1 0 0 0]
```

```
E =
     0     0     1     0     0     0
```

```
>> E*A
```

```
ans =
     9     4    -3    10     8
```

In the first case, EA was the first row of A , in the second case, EA was the third row of A . In general if E is all zeros except a 1 in the i th column, EA will be the i th row of A .

(b)

```
>> E = [2 0 0 0 0 0];
```

```
>> E*A
```

```
ans =
     8     6   -18    -6   -18
```

```
>> E = [ 0 0 2 0 0 0 ];
```

```
>> E*A
```

```
ans =
    18     8    -6    20    16
```

As above, EA will be the i th row of A , but this time it will be multiplied by 2.

(c) (i)

```
>> E = [1 0 1 0 0 0];
```

```
>> E*A
```

```
ans =
    13     7   -12     7    -1
```

(ii) Here EA is the sum of the first and third rows.

```
>> E = [ 2 0 1 0 0 0 ];
```

```
>> E*A
```

```
ans =
    17    10   -21     4   -10
```

Here, EA is the twice the first row plus the third row. In general EA will be made up by multiplying the i th row of A by the i th element of E , and then adding these rows together.

- (d) In general, if E is zero except for a p in the k th entry, then EA will be the k th row of A multiplied by p . To test this,

```
>> A = round( 10*(2*rand(3,5)-1))
A =
   -5   -9   -4   -1    5
   -8    0    8    9    5
    9   -2    1   -9    7

>> E = [ 0 3 0]; % A 3 in the 2nd entry.
>> E*A      % This will be the 2nd row of A, multiplied by 3.
ans =
  -24    0   24   27   15
```

This may be repeated with a different choice of E and A .

- (e) In general, if E has a p in the k th entry and a q in the j th entry, and zeros elsewhere, EA will be the k th row of A times p plus the j th row of A times q .

```
>> E = [0 3 1]; % 3 in the 2nd entry. 1 in the 3rd entry.
>> E*A      % This will be 3*(2nd row) + 1*(3rd row).
ans =
  -15   -2   25   18   22
```

This may be repeated with a different choice of E and A .

- (f) You should find the same results as in (d) and (e), except using columns instead of rows:

```
>> F = [0; 0; 2; 0; 0] % A 2 in the 3rd entry.
F =
    0
    0
    2
    0
    0

>> A*F % This will be 2 times the 3rd column of A.
ans =
   -8
   16
    2
```

This may be repeated with different A 's and F 's.

9. (a)

```
>> A = round( 10*(2*rand(3)-1))
A =
   -7    7    5
  -10    3   10
    4    5    8

>> B = round( 10*(2*rand(3)-1))
B =
   -5    0   -2
   -4    2    7
   -3    7   -5
```



```

>> UA = triu(A) % The upper triangular part of A.
UA =
    -7     7     5
     0     3    10
     0     0     8

>> UB = triu(B) % The upper triangular part of B.
UB =
    -5     0    -2
     0     2     7
     0     0    -5

>> UA*UB
ans =
    35    14    38
     0     6   -29
     0     0   -40

```

This has the property that $UA*UB$ is also upper triangular. When this is repeated for larger matrices, $UA*UB$ will still be upper triangular.

(b) If A and B are upper triangular matrices, then $C = AB$ is also an upper triangular matrix.

Proof: The matrix A is upper triangular when $a_{ij} = 0$ for any $i > j$. Since B is also upper triangular, $b_{ij} = 0$ when $i > j$. What we wish to show is that $c_{ij} = 0$ for $i > j$. If we use summation notation,

$$c_{ij} = \sum_{k=1}^n a_{ik}b_{kj}.$$

Split this sum into two sums: $k < i$ and $k \geq i$:

$$c_{ij} = \sum_{k=1}^{i-1} a_{ik}b_{kj} + \sum_{k=i}^n a_{ik}b_{kj}.$$

In the first sum, we have $i > k$ so $a_{ik} = 0$. In the second sum, we have $k \geq i > j$, so $b_{kj} = 0$. In either sum, we are just adding up 0, so $c_{ij} = 0$. Which implies that C is upper triangular.

(c) The product of two lower triangular matrices is also lower triangular. To test this, generate two random lower triangular matrices.:

```

>> A = tril( round( 10*(2*rand(3)-1)) )
A =
    -2     0     0
     0     7     0
    -7     2    -7

>> B = tril( round( 10*(2*rand(3)-1)) )
B =
    10     0     0
    -2    -5     0
    -7     0    -7

>> A*B % This is also lower triangular.
ans =
   -20     0     0
   -14   -35     0
   -25   -10    49

```

10. (a)

```
>> A = round( 10*(2*rand(5)-1))
A =
   -2   -7   -8   -7    6
   -6    9   -7    6    9
   -9   -2   -9   -1    3
    8   -7   -3   -3   -6
   -1    8   -5   -1    4
```

```
>> B = triu(A,1)
B =
    0   -7   -8   -7    6
    0    0   -7    6    9
    0    0    0   -1    3
    0    0    0    0   -6
    0    0    0    0    0
```

B is the matrix made from A with nonzero elements above the main diagonal. If we call the diagonal above the main diagonal the first diagonal and the one above that the second, and so on, B has zeros below the first diagonal. Type `help triu` for more information about `triu`.

```
>> B^2
ans =
    0    0   49  -34  -45
    0    0    0    7  -57
    0    0    0    0    6
    0    0    0    0    0
    0    0    0    0    0
```

B^2 has zeros below the second diagonal. Similarly, B^3 will have zeros below the third diagonal. $B^5 = 0$, so B is nilpotent with index 5.

(b)

```
>> B = triu(A,2)
B =
    0    0   -8   -7    6
    0    0    0    6    9
    0    0    0    0    3
    0    0    0    0    0
    0    0    0    0    0
```

This time, B has zeros below the second diagonal.

```
>> B^2
ans =
    0    0    0    0  -24
    0    0    0    0    0
    0    0    0    0    0
    0    0    0    0    0
    0    0    0    0    0
```

B^2 has zeros below the fourth diagonal. B^3 will be zero, so B is nilpotent with index 3.

(c) If we repeat (a) with a 7×7 matrix, we will find that B^k will have zeros below the k th diagonal. This means that B will be nilpotent with index 7. If we repeat (b) with a 7×7 matrix, we will

find that B^k will have zeros below the $2k$ th diagonal. This means that B will be nilpotent with index 4.

- (d) If we choose $B = \text{triu}(A, j)$, then B^k will have zeros below the $j \cdot k$ th diagonal. For a 6×6 matrix, B will be nilpotent with index 3 when we choose j to be the smallest number so that $j \cdot 3 \geq 6$, which is 2.

```
>> A = round( 10*(2*rand(6)-1))
A =
    7    -6    -5    -4     6    -7
   -8    -8     4    -6    -7    10
   -8    -2    -4   -10    -2    -5
    5     9     6    -6     2    -5
    3     9     6    10    -6    -8
   -6    -2    -2    -5     7    -6

>> C = triu(A,2)
C =
    0     0    -5    -4     6    -7
    0     0     0    -6    -7    10
    0     0     0     0    -2    -5
    0     0     0     0     0    -5
    0     0     0     0     0     0
    0     0     0     0     0     0

>> C^2 % This is not zero.
ans =
    0     0     0     0    10    45
    0     0     0     0     0    30
    0     0     0     0     0     0
    0     0     0     0     0     0
    0     0     0     0     0     0
    0     0     0     0     0     0

>> C^3 % This is zero. So index of nilpotency of C is 3.
ans =
    0     0     0     0     0     0
    0     0     0     0     0     0
    0     0     0     0     0     0
    0     0     0     0     0     0
    0     0     0     0     0     0
    0     0     0     0     0     0
```

11. First generate the eight matrices:

```
>> A = round( 6*( 2*rand(2) - 1))
A =
     3    -2
     6    -3

>> B = round( 6*( 2*rand(2) - 1))
B =
    -5     5
     2    -3
```

```

>> C = round( 6*( 2*rand(2) - 1))
C =
    -1     0
     3    -3

>> D = round( 6*( 2*rand(2) - 1))
D =
    -3    -4
    -2     0

>> E = round( 6*( 2*rand(2) - 1))
E =
     5    -5
     5     5

>> F = round( 6*( 2*rand(2) - 1))
F =
     0    -2
     0     6

>> G = round( 6*( 2*rand(2) - 1))
G =
     0    -5
    -3     5

>> H = round( 6*( 2*rand(2) - 1))
H =
    -5    -1
     0    -3

>> AA = [ A B; C D] % The block matrix.
AA =
     3    -2    -5     5
     6    -3     2    -3
    -1     0    -3    -4
     3    -3    -2     0

>> BB = [ E F; G H] % Another block matrix.
BB =
     5    -5     0    -2
     5     5     0     6
     0    -5    -5    -1
    -3     5     0    -3

>> AA*BB
ans =
    -10    25    25   -28
     24   -70   -10   -23
     7     0    15    17
     0   -20    10   -22

>> K = [ A*E+B*G  A*F+B*H;  C*E+D*G  C*F+D*H]
K =
    -10    25    25   -28
     24   -70   -10   -23
     7     0    15    17
     0   -20    10   -22

```

```
>> AA*BB - K
ans =
    0    0    0    0
    0    0    0    0
    0    0    0    0
    0    0    0    0
```

In fact, $AA*BB$ will always be the same as K .

12.

```
>> A = round( 10*(2*rand(3,4)-1))
A =
     8     9     5    -10
     1    -9     7     4
    -1     5    -7     7

>> B = round( 10*(2*rand(4,5)-1))
B =
     7    -1     1     0     8
    -5    -4     6     9     2
    -2    -6    -9     5     7
     1    -7     1     1    -7

>> D = A(:,1)*B(1,:) + A(:,2)*B(2,:) + ...
      A(:,3)*B(3,:) + A(:,4)*B(4,:)
D =
    -9    -4     7    96   187
    42   -35  -112  -42    11
   -11   -26    99    17   -96

>> D - A*B
ans =
     0     0     0     0     0
     0     0     0     0     0
     0     0     0     0     0
```

In general, D will be AB . To see this, notice that the k th term in this sum is the product of the k th column of A and the k th row of B . The ij th entry in this matrix will be: $a_{ik}b_{kj}$. When we add together all of the matrices, the ij th entry will be $\sum_{k=1}^n a_{ik}b_{kj}$, which is the ij th entry of AB .

13. (a)

```
>> AB = zeros(3,5);
>> AB(1,[1 2]) = [1 1];
>> AB(2,[2 3]) = [1 1];
>> AB(3,[1 4 5]) = [1 1 1]
AB =
     1     1     0     0     0
     0     1     1     0     0
     1     0     0     1     1
```

```

>> BC = zeros(5,8);
>> BC(1,[1 3 5]) = [1 1 1];
>> BC(2,[3 4 7]) = [1 1 1];
>> BC(3,[1 5 6 8]) = [1 1 1 1];
>> BC(4,8) = 1;
>> BC(5,[5 6 7]) = [1 1 1]
BC =
     1     0     1     0     1     0     0     0
     0     0     1     1     0     0     1     0
     1     0     0     0     1     1     0     1
     0     0     0     0     0     0     0     1
     0     0     0     0     1     1     1     0

>> CD = zeros(8,10);
>> CD(1,[1 2 3]) = [1 1 1];
>> CD(2,[3 4 6]) = [1 1 1];
>> CD(3,[8 9 10]) = [1 1 1];
>> CD(4,[4 5 7]) = [1 1 1];
>> CD(5,[1 4 6 8]) = [1 1 1 1];
>> CD(6,[2 4]) = [1 1];
>> CD(7,[1 5 9]) = [1 1 1];
>> CD(8,[1 2 4 6 7 9 10]) = [1 1 1 1 1 1 1]
CD =
     1     1     1     0     0     0     0     0     0     0
     0     0     1     1     0     1     0     0     0     0
     0     0     0     0     0     0     0     1     1     1
     0     0     0     1     1     0     1     0     0     0
     1     0     0     1     0     1     0     1     0     0
     0     1     0     1     0     0     0     0     0     0
     1     0     0     0     1     0     0     0     1     0
     1     1     0     1     0     1     1     0     1     1

```

- (b) Person i in group 1 will have contact through person j in group 3 through person k in group 2 if $AB_{ik} = 1$ and $BC_{kj} = 1$, or in other words $AB_{ik}BC_{kj} = 1$. If we sum over k , this will tell us how many indirect contacts person i has with person j . So the indirect contact matrix will be $AB \cdot BC$. Similarly, to get from group 1 to group 4 via groups 2 and 3, we will multiply all three matrices together:

```

>> AD = AB*BC*CD
AD =
     3     1     1     2     2     1     1     3     3     2
     4     3     1     4     2     2     2     2     3     2
     5     3     1     4     1     3     1     3     3     2

```

None of the entries are zero. This signifies that everybody in group 1 has some indirect contact with each person in group 4. Since the (1,5) entry is 2, there are 2 different paths that connect person 1 in group 1 with person 5 in group 4. Similarly, since the (2,1) entry is 4, there are 4 different paths connecting person 2 in group 1 with person 1 in group 4.

- (c) In order to find the total number of contacts a person in group 4 has, we add the rows of the indirect contact matrix. From problem 12, we see that a simple way to do this is to multiply by $[1 \ 1 \ 1]$.

```

>> ones(1,3) * AD
ans =
    12     7     3    10     5     6     4     8     9     6

```

The person with the most indirect contacts is person 1, with 12 contacts. Person 3 has 3 contacts, which is the least. Similarly, we can add the columns together to find out how many indirect contacts each person in group 1 has.

```
>> AD * ones(10,1)
ans =
    19
    25
    26
```

Person 3 has the most indirect contacts with people in group 4, and so is the most dangerous.

14. (a) Column one means that of the households using product 1, after one month 80/switch to product 3. Column two means that of the households using product 2, after one month 75/switch to product 3. Column three means that of the households using product 3, after one month 90/switch to product 2.
- (b) Since x is the distribution of households using the products after 0 months, Px will be the distribution of households using the products after 1 month. Similarly, $P^k x$ will be how many households use each product after k months.
- (c)

```
>> x = [10000; 10000; 10000];
>> P = [ .8 .2 .05
         .05 .75 .05
         .15 .05 .9 ]
P =
    0.8000    0.2000    0.0500
    0.0500    0.7500    0.0500
    0.1500    0.0500    0.9000
```

It may be convenient to round off your answers. One way to do this is to set the output format to `bank`. This rounds numbers to the nearest hundredth.

```
>> format bank
>> P^5 * x
ans =
    10275.83
     5840.35
    13883.83

>> P^10 * x
ans =
     9477.30
     5141.24
    15381.46

>> P^15 * x
ans =
     9142.60
     5023.74
    15833.66

>> P^20 * x
ans =
     9038.77
     5003.99
    15957.24
```

```

>> P^25 * x
ans =
    9010.03
    5000.67
   15989.30

>> P^30 * x
ans =
    9002.52
    5000.11
   15997.37

>> P^35 * x
ans =
    9000.62
    5000.02
   15999.36

>> P^40 * x
ans =
    9000.15
    5000.00
   15999.85

>> P^45 * x
ans =
    9000.04
    5000.00
   15999.96

>> P^50 * x
ans =
    9000.01
    5000.00
   15999.99

```

As n gets larger, $P^n \mathbf{x}$ tends to $(900, 500, 1600)$. This may be interpreted by saying that eventually every month the same number of households switch to product i , as switch from product i , for $i = 1, 2, 3$.

(d)

```

>> x = [0; 30000; 0];
>> P^5 * x
ans =
   12056.86
    9201.75
    8741.39

>> P^50 * x
ans =
    9000.04
    5000.00
   15999.96

```

Although for small n , $P^n \mathbf{x}$ is different from that in (c), for large n , $P^n \mathbf{x}$ tends to the same value: $(9000, 5000, 16000)$.

(e) For any choice of \mathbf{x} , $P^n \mathbf{x}$ will tend to the same vector: $P^n \mathbf{x} \rightarrow (9000, 5000, 16000)$.

(f)

```
>> P^50
ans =
    0.30    0.30    0.30
    0.17    0.17    0.17
    0.53    0.53    0.53

>> 30000 * P^50
ans =
    9000.00    9000.04    8999.99
    5000.00    5000.00    5000.00
   16000.00   15999.96   16000.01
```

When n is large, the columns of $30000P^n$ are very close to each other, and to the vector $(9000, 5000, 15000)$. So that when $30000P^n$ is multiplied by any vector \mathbf{x} , it will be close to $(x_1 + x_2 + x_3)$ times this vector.

(g)

```
>> P = [.8 .1 .1; .05 .75 .1; .15 .15 .8];
>> n = 50; % Try this for n= 5,10,15,25...
>> 1000 * P^n
ans =
    333.33    333.33    333.33
    238.10    238.10    238.10
    428.57    428.57    428.57

>> format % Don't forget to return to normal output format at
>> % the end of this problem.
```

In the limit, the columns of $1000P^n$ tend to the vector $(333.33, 238.1, 428.57)$. This will be the long term distribution of cars no matter what the starting distribution is. A car rental agency could use this information by planning to have a larger parking lot at office 3 than at office 1, or by planning to hire more mechanics at office 3 than at office 1.

15. (a) Column 1 says that 40% of the fish in group 1 survive to belong to group 2 the next year. Column 2 says that 20% of the fish in group 2 stay in group 2, and 50% of the fish in group 2 survive to be in group 3 the next year. This would happen if group 2 covers fish in an age range of more than 1 year. Column 3 says that each fish in group 3 has 2 babies, and that 20% survive and stay in group 3, and 50% survive and enter group 4. Column 4 says that each fish in group 4 has 2 babies, and then 20% survive to stay in group 4 and 40% survive to enter group 5. Column 5 says that each fish in group 5 has a 10% chance of survival to stay in group 5.

- (b) If \mathbf{x} is the distribution of fish at this moment, then $\mathbf{y} = S\mathbf{x}$ will be the number of fish after one year. Since \mathbf{y} is also a distribution of fish, $S\mathbf{y} = S \cdot S\mathbf{x} = S^2\mathbf{x}$ will be the number of fish one year later, or two years from now.

(c)

```
>> S = [ 0  0  2  2  0
        .4 .2  0  0  0
         0 .5 .2  0  0
         0  0 .5 .2  0
         0  0  0 .4 .1 ];
```

```

>> x = [5000; 10000; 20000; 20000; 5000];
>> n = 10; floor(S^n*x)
ans =
    41016
    21666
    12949
     7754
     3709

>> % repeat for n=20,30, ...
>> n = 50; floor(S^n*x)
ans =
    49063
    24412
    15183
     9443
     4179

```

After about 10 years, the population grows steadily. The growth rate will be exponential.

(d)

```

>> S(1,3) = 1;
>> n = 10; floor(S^n*x)
ans =
    15774
     8573
     5572
     4100
     2105

>> % repeat for n=20,30, ...
>> n = 50; floor(S^n*x)
ans =
     550
     305
     212
     147
      71

```

This time, the population decays exponentially. Not enough new fish are being born to keep the population steady.

```

>> S(1,3) = 2; S(3,2) = .3;
>> n = 10; floor(S^n*x)
ans =
    13280
     8007
     3334
     2438
     1321

>> % repeat for n=20,30, ...
>> n = 50; floor(S^n*x)
ans =
     100
      58
      25
      18
       9

```

Again, the total population decays when the survival rate from group 2 into group 3 is dropped from 50% down to 30%. Not enough fish survive to be group 3 in order to create new fish.

- (e) At the end of the first year, the number of fish that have survived will be Sx . If we harvest h of these fish, we will end up with $u = Sx - h$ fish. Similarly, Su will be the number of these remaining fish that survive to the end of the second year. If we harvest h of these, we will have $Su - h$ fish remaining.
- (f)

```
>> S(1,3) = 2; S(3,2) = .5;
>> h = [0;0;0;0;2000];
>> u = S*x - h
u =
    80000
     4000
     9000
    14000
     6500

>> u = S*u - h % This command should be repeated several times.
u =
    46000
    32800
     3800
     7300
     4250
```

After two more iterations of the last command, the vector u will have a negative number in the last entry. This means that we may harvest this many fish for 3 years, and at the end of the fourth year, there will be less than 2000 mature fish to be harvested.

- (g) After repeating the following experiment, for different values of n , you will find that u begins to drop for the first few years, and then begins to increase after about 5 years. If n is chosen to be 1530 or smaller, u will never be negative.

```
>> n = 1530;
>> h = [0;0;0;0;n];
>> u = S*x - h
u =
    80000
     4000
     9000
    14000
     6970

>> u = S*u - h % This step should be repeated several times, until
>> % u begins to rise again.
u =
    46000
    32800
     3800
     7300
     4767
```

- (h) If the above experiment is repeated using nonzero values in the last two entries of h , the total harvest can be improved. For example, if $h = (0, 0, 0, 1500, 790)$, the total harvest will be 2290, and the population of fish will not become negative over 15 years. These values can be improved by slightly changing h .

Section 1.7

1.
$$\begin{pmatrix} 2 & -1 \\ 4 & 5 \end{pmatrix} \begin{pmatrix} x_1 \\ x_2 \end{pmatrix} = \begin{pmatrix} 3 \\ 7 \end{pmatrix}$$

2.
$$\begin{pmatrix} 1 & -1 & 3 \\ 4 & 1 & -1 \\ 2 & -1 & 3 \end{pmatrix} \begin{pmatrix} x_1 \\ x_2 \\ x_3 \end{pmatrix} = \begin{pmatrix} 11 \\ -4 \\ 10 \end{pmatrix}$$

3.
$$\begin{pmatrix} 3 & 6 & -7 \\ 2 & -1 & 3 \end{pmatrix} \begin{pmatrix} x_1 \\ x_2 \\ x_3 \end{pmatrix} = \begin{pmatrix} 0 \\ 1 \end{pmatrix}$$

4.
$$\begin{pmatrix} 4 & -1 & 1 & -1 \\ 3 & 1 & -5 & 6 \\ 2 & -1 & 1 & 0 \end{pmatrix} \begin{pmatrix} x_1 \\ x_2 \\ x_3 \\ x_4 \end{pmatrix} = \begin{pmatrix} -7 \\ 8 \\ 9 \end{pmatrix}$$

5.
$$\begin{pmatrix} 0 & 1 & -1 \\ 1 & 0 & 1 \\ 3 & 2 & 0 \end{pmatrix} \begin{pmatrix} x_1 \\ x_2 \\ x_3 \end{pmatrix} = \begin{pmatrix} 7 \\ 2 \\ -5 \end{pmatrix}$$

6.
$$\begin{pmatrix} 2 & 3 & -1 \\ -4 & 2 & 1 \\ 7 & 3 & -9 \end{pmatrix} \begin{pmatrix} x_1 \\ x_2 \\ x_3 \end{pmatrix} = \begin{pmatrix} 0 \\ 0 \\ 0 \end{pmatrix}$$

7.
$$\begin{aligned} x_1 + x_2 - x_3 &= 7 \\ 4x_1 - x_2 + 5x_3 &= 4 \\ 6x_1 + x_2 + 3x_3 &= 20 \end{aligned}$$

8.
$$\begin{aligned} x_2 &= 2 \\ x_1 &= 3 \end{aligned}$$

9.
$$\begin{aligned} 2x_1 + x_3 &= 2 \\ -3x_1 + 4x_2 &= 3 \\ 5x_2 + 5x_3 &= 5 \end{aligned}$$

10.
$$\begin{aligned} 2x_1 + 3x_2 + x_3 &= 2 \\ 4x_2 + x_3 &= 3 \end{aligned}$$

11.
$$\begin{aligned} x_1 &= 2 \\ x_2 &= 3 \\ x_3 &= -5 \\ x_4 &= 6 \end{aligned}$$

12.
$$\begin{aligned} 2x_1 + 3x_2 + x_3 &= 0 \\ 4x_1 - x_2 + 5x_3 &= 0 \\ 3x_1 + 6x_2 - 7x_3 &= 0 \end{aligned}$$

13.
$$\begin{aligned} 6x_1 + 2x_2 + x_3 &= 2 \\ -2x_1 + 3x_2 + x_3 &= 4 \\ 0 &= 2 \end{aligned}$$

14.
$$\begin{aligned} 3x_1 + x_2 + 5x_3 &= 6 \\ 2x_1 + 3x_2 + 2x_3 &= 4 \end{aligned}$$

15.
$$\begin{aligned} 7x_1 + 2x_2 &= 1 \\ 3x_1 + x_2 &= 2 \\ 6x_1 + 9x_2 &= 3 \end{aligned}$$

16.
$$A = \begin{pmatrix} 2 & 0 & 0 \\ 0 & 4 & 0 \\ 0 & 0 & -5 \end{pmatrix}, \mathbf{x} = \begin{pmatrix} x_1 \\ x_2 \\ x_3 \end{pmatrix}, \mathbf{b} = \begin{pmatrix} 3 \\ 5 \\ 2 \end{pmatrix}, x_1 = 3/2, x_2 = 5/4, x_3 = -2/5$$

17.
$$\left(\begin{array}{cc|c} 1 & -3 & 2 \\ -2 & 6 & -4 \end{array} \right) \rightarrow \left(\begin{array}{cc|c} 1 & -3 & 2 \\ 0 & 0 & 0 \end{array} \right), \mathbf{x}_p = (2, 0); \left(\begin{array}{cc|c} 1 & -3 & 0 \\ -2 & 6 & 0 \end{array} \right) \rightarrow \left(\begin{array}{cc|c} 1 & -3 & 0 \\ 0 & 0 & 0 \end{array} \right), \mathbf{x}_h = x_2(3, 1),$$

$$\mathbf{x} = (2, 0) + x_2(3, 1)$$

18.
$$\left(\begin{array}{ccc|c} 1 & -1 & 1 & 6 \\ 3 & -3 & 3 & 18 \end{array} \right) \rightarrow \left(\begin{array}{ccc|c} 1 & -1 & 1 & 6 \\ 0 & 0 & 0 & 0 \end{array} \right) \quad \mathbf{x}_p = (6, 0, 0)$$

$$\left(\begin{array}{ccc|c} 1 & -1 & 1 & 0 \\ 3 & -3 & 3 & 0 \end{array} \right) \rightarrow \left(\begin{array}{ccc|c} 1 & -1 & 1 & 0 \\ 0 & 0 & 0 & 0 \end{array} \right) \quad \mathbf{x}_h = (x_2 - x_3, x_2, x_3)$$

$$\mathbf{x} = (6, 0, 0) + (x_2 - x_3, x_2, x_3)$$

19.
$$\left(\begin{array}{ccc|c} 1 & -1 & -1 & 2 \\ 2 & 1 & 2 & 4 \\ 1 & -4 & -5 & 2 \end{array} \right) \rightarrow \left(\begin{array}{ccc|c} 1 & -1 & -1 & 2 \\ 0 & 3 & 4 & 0 \\ 0 & -3 & -4 & 0 \end{array} \right) \rightarrow \left(\begin{array}{ccc|c} 1 & 0 & 1/3 & 2 \\ 0 & 1 & 4/3 & 0 \\ 0 & 0 & 0 & 0 \end{array} \right) \quad \mathbf{x}_p = (2, 0, 0)$$

$$\left(\begin{array}{ccc|c} 1 & -1 & -1 & 0 \\ 2 & 1 & 2 & 0 \\ 1 & -4 & -5 & 0 \end{array} \right) \rightarrow \left(\begin{array}{ccc|c} 1 & -1 & -1 & 0 \\ 0 & 3 & 4 & 0 \\ 0 & -3 & -4 & 0 \end{array} \right) \rightarrow \left(\begin{array}{ccc|c} 1 & 0 & 1/3 & 0 \\ 0 & 1 & 4/3 & 0 \\ 0 & 0 & 0 & 0 \end{array} \right) \quad \mathbf{x}_h = x_3(-1/3, -4/3, 1)$$

$$\mathbf{x} = (2, 0, 0) + x_3(-1/3, -4/3, 1)$$

$$20. \left(\begin{array}{ccc|c} 1 & -1 & -1 & 2 \\ 2 & 1 & 2 & 4 \\ 1 & -4 & -5 & 2 \end{array} \right) \rightarrow \left(\begin{array}{ccc|c} 1 & -1 & -1 & 2 \\ 0 & 3 & 4 & 0 \\ 0 & -3 & -4 & 0 \end{array} \right) \rightarrow \left(\begin{array}{ccc|c} 1 & 0 & 1/3 & 2 \\ 0 & 1 & 4/3 & 0 \\ 0 & 0 & 0 & 0 \end{array} \right) \quad \mathbf{x}_p = (2, 0, 0)$$

$$\left(\begin{array}{ccc|c} 1 & -1 & -1 & 0 \\ 2 & 1 & 2 & 0 \\ 1 & -4 & -5 & 0 \end{array} \right) \rightarrow \left(\begin{array}{ccc|c} 1 & -1 & -1 & 0 \\ 0 & 3 & 4 & 0 \\ 0 & -3 & -4 & 0 \end{array} \right) \rightarrow \left(\begin{array}{ccc|c} 1 & 0 & 1/3 & 0 \\ 0 & 1 & 4/3 & 0 \\ 0 & 0 & 0 & 0 \end{array} \right) \quad \mathbf{x}_h = x_3(-1/3, -4/3, 1)$$

$$\mathbf{x} = (2, 0, 0) + x_3(-1/3, -4/3, 1)$$

$$21. \left(\begin{array}{cccc|c} 1 & 1 & -1 & 2 & 3 \\ 3 & 2 & 1 & -1 & 5 \end{array} \right) \rightarrow \left(\begin{array}{cccc|c} 1 & 1 & -1 & 2 & 3 \\ 0 & -1 & 4 & -7 & -4 \end{array} \right) \rightarrow \left(\begin{array}{cccc|c} 1 & 0 & 3 & -5 & -1 \\ 0 & 1 & -4 & 7 & 4 \end{array} \right) \quad \mathbf{x}_p = (-1, 4, 0, 0)$$

$$\left(\begin{array}{cccc|c} 1 & 1 & 0 & 1 & 2 & 3 \\ 3 & 2 & 1 & -1 & 5 \end{array} \right) \rightarrow \left(\begin{array}{cccc|c} 1 & 1 & -1 & 2 & 3 \\ 0 & -1 & 4 & -7 & -4 \end{array} \right) \rightarrow \left(\begin{array}{cccc|c} 1 & 0 & 3 & -5 & -1 \\ 0 & 1 & -4 & 7 & 4 \end{array} \right)$$

$$\mathbf{x}_h = (-3x_3 + 5x_4, 4x_3 - 7x_4, x_3, x_4)$$

$$\mathbf{x} = (-1, 4, 0, 0) + (-3x_3 + 5x_4, 4x_3 - 7x_4, x_3, x_4)$$

$$22. \left(\begin{array}{cccc|c} 1 & -1 & 1 & -1 & -2 \\ -2 & 3 & -1 & 2 & 5 \\ 4 & -2 & 2 & -3 & 6 \end{array} \right) \rightarrow \left(\begin{array}{cccc|c} 1 & -1 & 1 & -1 & -2 \\ 0 & 1 & 1 & 0 & 1 \\ 0 & 2 & 2 & 1 & 14 \end{array} \right) \rightarrow \left(\begin{array}{cccc|c} 1 & 0 & 2 & -1 & -1 \\ 0 & 1 & 1 & 0 & 1 \\ 0 & 0 & -4 & 1 & 12 \end{array} \right) \rightarrow \left(\begin{array}{cccc|c} 1 & 0 & 0 & -1/2 & 5 \\ 0 & 1 & 0 & 1/4 & 4 \\ 0 & 0 & 1 & -1/4 & -3 \end{array} \right)$$

$$\mathbf{x}_p = (5, 4, -3, 0)$$

$$\left(\begin{array}{cccc|c} 1 & -1 & 1 & -1 & 0 \\ -2 & 3 & -1 & 2 & 0 \\ 4 & -2 & 2 & -3 & 0 \end{array} \right) \rightarrow \left(\begin{array}{cccc|c} 1 & -1 & 1 & -1 & 0 \\ 0 & 1 & 1 & 0 & 0 \\ 0 & 2 & 2 & 1 & 0 \end{array} \right) \rightarrow \left(\begin{array}{cccc|c} 1 & 0 & 2 & -1 & 0 \\ 0 & 1 & 1 & 0 & 0 \\ 0 & 0 & -4 & 1 & 0 \end{array} \right) \rightarrow \left(\begin{array}{cccc|c} 1 & 0 & 0 & -1/2 & 0 \\ 0 & 1 & 0 & 1/4 & 0 \\ 0 & 0 & 1 & -1/4 & 0 \end{array} \right)$$

$$\mathbf{x}_h = x_4(1/2, -1/4, 1/4, 1)$$

$$\mathbf{x} = (5, 4, -3, 0) + x(1/2, -1/4, 1/4, 1)$$

23. Plugging $y = c_1y_1 + c_2y_2$ into the left side of the differential equation gives, since $(cy)'' = cy''$ and $(y_1 + y_2)'' = y_1'' + y_2''$

$$\begin{aligned} c_1y_1'' + c_2y_2'' + a(x)(c_1y_1' + c_2y_2') + b(x)(c_1y_1 + c_2y_2) &= c_1(y_1'' + a(x)y_1' + b(x)y_1) + c_2(y_2'' + a(x)y_2' + b(x)y_2) \\ &= c_1(0) + c_2(0) = 0 \end{aligned}$$

$$\begin{aligned} 24. \quad y_p'' - y_q'' + a(x)(y_p' - y_q') + b(x)(y_p - y_q) \\ &= (y_p'' + a(x)y_p' + b(x)y_p) - (y_q'' + a(x)y_q' + b(x)y_q) \\ &= f(x) - f(x) = 0 \end{aligned}$$

Thus, $y_p(x) - y_q(x)$ solves $y''(x) + a(x)y'(x) + b(x)y(x) = 0$.

MATLAB 1.7

1. (a)

```

>> A = round(10*( 2*rand(3)-1))
A =
   -6     4     0
   -9     9     7
    4    -2    -9

>> b = round(10*(2*rand(3,1)-1))
b =
   -9
    1
    3

>> R = rref([A b])
R =
   1.0000         0         0   3.8053
         0   1.0000         0   3.4579
         0         0   1.0000   0.5895

>> x = R(:,4)
x =
   3.8053
   3.4579
   0.5895

>> A*x % First find A*x
ans =
  -9.0000
   1.0000
   3.0000

>> A*x - b % Compare Ax with b.
ans =
  1.0e-14 *
         0
  -0.2665
   0.0888

```

In theory, $Ax - b$ should be zero, but in practice, the computer will have some round-off error. Here the error is on the order of 10^{-14} .

```

>> y = x(1)*A(:,1) + x(2)*A(:,2) + x(3)*A(:,3)
y =
  -9.0000
   1.0000
   3.0000

>> y-b
ans =
  1.0e-14 *
         0
  -0.2665
   0.0888

```

Again, y is the same as $A * x$, so it will be b up to some round-off error.

(b) (i)

```
>> A = [4 9 17 5
        2 1 5 -1
        5 9 19 4
        9 5 23 -4 ]
```

```
>> b = [11; 9; 16; 40];
```

```
>> R = rref([A b])
```

```
R =
    1     0     2    -1     5
    0     1     1     1    -1
    0     0     0     0     0
    0     0     0     0     0
```

The general solution will have x_3 and x_4 arbitrary, $x_1 = -2x_3 + x_4 + 5$, and $x_2 = -x_3 - x_4 - 1$. We may pick, for example, $x_3 = 1$ and $x_4 = 0$, to get the particular solution:

```
>> x = [3; -2; 1; 0];
```

(ii)

```
>> A*x % This should be the same as b.
```

```
ans =
    11
     9
    16
    40
```

```
>> y = x(1)*A(:,1) + x(2)*A(:,2) + x(3)*A(:,3) + x(4)*A(:,4)
```

```
y =
    11
     9
    16
    40
```

As in (a), if \mathbf{x} is a solution of the system with $[A \ \mathbf{b}]$ as augmented matrix, $A\mathbf{x} = \mathbf{b}$, then $A\mathbf{x}$ and $x_1A(:,1) + \dots + x_4A(:,4) = \mathbf{y}$ are both \mathbf{b} .

(iii) If this is repeated with other choices of x_3 and x_4 , the same results will occur: $A\mathbf{x} = \mathbf{b}$ and $\mathbf{y} = \mathbf{b}$. For example:

```
>> x = [ 4; -3; 1; 1];
```

```
>> A*x
```

```
ans =
    11
     9
    16
    40
```

(iv)

```
>> y = x(1)*A(:,1) + x(2)*A(:,2) + x(3)*A(:,3) + x(4)*A(:,4)
```

```
y =
    11
     9
    16
    40
```

(c) The solution of a system of equations represented by $[A \ \mathbf{b}]$ is the same as the solution of the matrix equation $A\mathbf{x} = \mathbf{b}$. Also, multiplying a matrix by a single column is equivalent to adding multiples of the columns of this matrix.

2. (a) The ij entry of Ax is the inner product of the i th row of A with the j th column of x . Since x has only one column, j must always be 1, and the first column of x is just x itself. Since $Ax = 0$, the inner product of the i th row of A with x is zero. This means that the i th row is orthogonal to x .
- (b) This can be done by solving $Ax = 0$ where A is the matrix whose rows are the given vectors.

```
>> A = [1 2 -3 0 4; 5 -5 2 0 1];
>> rref(A)
ans =
    1.0000         0   -0.7333         0    1.4667
         0    1.0000   -1.1333         0    1.2667
```

For a solution, we may choose x_3 , x_4 , and x_5 arbitrarily, and then set $x_1 = .7333x_3 - 1.4667x_5$ and $x_2 = 1.1333x_3 - 1.2667x_5$.

3. (a) The matrix x solves the nonhomogeneous system $Ax = b$. The matrix z was a solution of the homogeneous system $Az = 0$. If we set $y = x + sz$, then we found that y was also a solution of the nonhomogeneous system $Ay = b$. The corollary tells us the converse, i.e. that any such solution can be written as $y = x + sh$ where H is a solution of $Ah = 0$.
- (b) (i) Refer to the solution of 1(b) above. The matrix R is the reduced echelon form of $[A \ b]$. Since two variables can be chosen arbitrarily in the solution of $Ax = b$, there are infinitely many solutions.
- (ii)

```
>> x = A\b

Warning: Matrix is singular to working precision.

x =
    Inf
    Inf
    Inf
    Inf

>> % Since A is singular, it has no inverse. Instead, enter a solution
>> % from the answer to 1(b).
>> x = [ 5; -1; 0; 0];
```

(iii)

```
>> rref(A)
ans =
     1     0     2    -1
     0     1     1     1
     0     0     0     0
     0     0     0     0
```

Solutions of $Ax = 0$ are of the form x_3 and x_4 are arbitrary, $x_1 = -2x_3 + x_4$, and $x_2 = -x_3 - x_4$.

Pick one solution, with $x_3 = 1, x_4 = 0$

```
>> z = [-2; -1; 1; 0];
>> A*(x+z) % This should yield b.
ans =
    11
     9
    16
    40
```

Another solution, with $x_3 = 0$, $x_4 = 1$.

```
>> z = [1; -1; 0; 1];
>> A*(x+z) % Again, this should be b.
ans =
    11
     9
    16
    40
```

This can be repeated two more times by choosing other values for x_3 and x_4 .

4. (a)

```
>> A = [ 5 5 8 0
         4 5 8 7
         3 9 8 9
         9 1 1 6];
```

```
>> rref(A)
ans =
     1     0     0     0
     0     1     0     0
     0     0     1     0
     0     0     0     1
```

If we were to reduce $[A \ b]$ for any b , we would still have the same left hand side. Since there is a pivot in every row, the system will be consistent, and there will be a unique solution.

(b) If we solve $Ax = b$, for x , then we may write b as

$$b = c_1x_1 + c_2x_2 + c_3x_3 + c_4x_4$$

where c_i is the i th column of A . For example:

```
>> b = round( 10*(2*rand(4,1)-1))
b =
    -6
    -9
     4
     4

>> R = rref([A b])
R =
    1.0000     0     0     0    0.6476
     0    1.0000     0     0    3.5799
     0     0    1.0000     0   -3.3922
     0     0     0     1    -0.3361

>> x = R(:,5)
x =
    0.6476
    3.5799
   -3.3922
   -0.3361
```

```
>> % Now we may write b as a combination of columns of A:
>> y = A(:,1)*x(1) + A(:,2)*x(2) + A(:,3)*x(3) +A(:,4)*x(4)
y =
-6.0000
-9.0001
 3.9999
 3.9999
```

Up to round off error, y is the same as b . This can be repeated two more times.

(c)

```
>> A = [ 5 5 -5 0
        4 5 -6 7
        3 9 -15 9
        9 1 7 6];

>> rref(A)
ans =
 1 0 1 0
 0 1 -2 0
 0 0 0 1
 0 0 0 0
```

It is possible that there is a b for which the reduced form of $[A \ b]$ does not have a zero in the (4,5) entry. Since the left hand side has all zeros in the fourth row, this would mean the system is inconsistent. By experimenting with several possible b you can find that if $b = (1, 0, 0, 0)^t$, there will be no solution:

```
>> b = [1; 0; 0; 0];
>> rref([A b])
ans =
 1 0 1 0 0
 0 1 -2 0 0
 0 0 0 1 0
 0 0 0 0 1
```

Notice that the above solution is inconsistent.

(d) If you start with a vector b which is a combination of columns of A , then there will always be a solution of $Ax = b$.

```
>> k = round( 10*(2*rand(4,1)-1)) % generate 4 random numbers.
k =
 9
-2
 0
 7

>> % Write b as a combination of columns of A:
>> b = A(:,1)*k(1) + A(:,2)*k(2) + A(:,3)*k(3) +A(:,4)*k(4)
b =
35.0000
23.6475
 5.9754
76.9836
```

```
>> rref([ A b])
ans =
    1.0000         0    1.0000         0    9.0000
         0    1.0000   -2.0000         0   -2.0000
         0         0         0    1.0000   -0.3361
         0         0         0         0         0
```

This system is consistent.

- (e) To see that this system will always have a solution, we only need to show that it has at least one solution. However, writing \mathbf{b} as a combination of columns of A using the scalars k_i , is equivalent to the matrix multiplication $A\mathbf{k} = \mathbf{b}$. This means that the vector \mathbf{k} will be a solution of $A\mathbf{x} = \mathbf{b}$. Since the system has a solution, it is consistent.

5. (a) (i) For A from 4(c):

```
>> A = [ 5 5 -5 0
         4 5 -6 7
         3 9 -15 9
         9 1 7 6];
```

```
>> rref(A)
ans =
    1     0     1     0
    0     1    -2     0
    0     0     0     1
    0     0     0     0
```

- (ii) The solutions of this homogeneous system have x_3 arbitrary, and $x_1 = -x_3$, $x_2 = 2x_3$, and $x_4 = 0$.
- (iii) If we set $x_3 = 1$, then we have $x_1 = -1$ and $x_2 = 2$. This corresponds to

$$0 = A\mathbf{x} = -1\mathbf{c}_1 + 2\mathbf{c}_2 + 1\mathbf{c}_3 + 0\mathbf{c}_4,$$

where \mathbf{c}_i is the i th column of A . Which can be rewritten as

$$\mathbf{c}_3 = 1\mathbf{c}_1 - 2\mathbf{c}_2.$$

To check this:

```
>> 1*A(:,1) - 2*A(:,2) % This should be the same as A(:,3).
ans =
    -5
    -6
   -15
     7

>> A(:,3) % This is the third column.
ans =
    -5
    -6
   -15
     7
```

- (iv) This system only allows one arbitrary variable.
- (v) If we let \mathbf{x} be the third column of $\mathbf{rref}(A)$ then $A\mathbf{x}$ will be the third column of A .

(b)

```
>> A = [4 9 17 5
        2 1 5 -1
        5 9 19 4
        9 5 23 -4];
```

```
>> rref(A)
ans =
    1     0     2    -1
    0     1     1     1
    0     0     0     0
    0     0     0     0
```

The solution of this system will have x_3 and x_4 arbitrary, and $x_1 = -2x_3 + x_4$, and $x_2 = -x_3 - x_4$. If $x_3 = 1$ and $x_4 = 0$, then we have $x_1 = -2$ and $x_2 = -1$. This corresponds to

$$c_3 = 2c_1 + 1c_2.$$

Similarly, if $x_3 = 0$ and $x_4 = 1$, then we have $x_1 = 1$ and $x_2 = -1$. This corresponds to

$$c_4 = -1c_1 + 1c_2.$$

As above, if x is the third column of $\text{rref}(A)$ then Ax will be the third column of A . Similarly, if x is fourth column of $\text{rref}(A)$ then Ax will be the fourth column of A . To check this:

```
>> R = rref(A);
>> x = R(:,3)
x =
    2
    1
    0
    0

>> A*x % This will be the 3rd column of A.
ans =
    17
     5
    19
    23

>> x = R(:,4)
x =
   -1
     1
     0
     0

>> A*x % This is the 4th column of A.
ans =
     5
    -1
     4
    -4
```

(c) First we generate a random matrix and modify it as directed.

```
>> A = round( 10*(2*rand(6,6)-1));
>> A(:,3) = 2*A(:,2) - 3*A(:,1);
>> A(:,5) = -A(:,1) + 2*A(:,2) - 3*A(:,4);
>> A(:,6) = A(:,2) + 4*A(:,4)
```

```
A =
    10     8    -14    -9    33   -28
     4    -5   -22     8   -38    27
     5    -1   -17     0    -7    -1
     3     5     1     0     7     5
    -9     0    27    -4    21   -16
     3    -5   -19    10   -43    35
```

```
>> R = rref(A)
```

```
R =
     1     0    -3     0    -1     0
     0     1     2     0     2     1
     0     0     0     1    -3     4
     0     0     0     0     0     0
     0     0     0     0     0     0
     0     0     0     0     0     0
```

This will be the same, for almost every random matrix that we start with. The solution of this system has x_3 , x_5 , and x_6 arbitrary and $x_1 = 3x_3 + x_5$, $x_2 = -2x_3 - 2x_5 - x_6$, and $x_4 = 3x_5 - 4x_6$. As in (b) above, if we set one of the three arbitrary variables to 1 and the others to 0, and write out \mathbf{x} we will get:

$$\mathbf{x} = \begin{pmatrix} -3 \\ 2 \\ 0 \\ 0 \\ 0 \\ 0 \end{pmatrix}, \mathbf{x} = \begin{pmatrix} -1 \\ 2 \\ 0 \\ -3 \\ 0 \\ 0 \end{pmatrix}, \text{ or } \mathbf{x} = \begin{pmatrix} 0 \\ 1 \\ 0 \\ 4 \\ 0 \\ 0 \end{pmatrix}.$$

Writing out $A\mathbf{x} = 0$ as a linear combination of columns of A , we will get the original equations:

```
>> A(:,3) = 2*A(:,2) - 3*A(:,1);
>> A(:,5) = -A(:,1) + 2*A(:,2) - 3*A(:,4);
>> A(:,6) = A(:,2) + 4*A(:,4)
```

Section 1.8

1. Since $\det A = 2 \cdot 2 - 3 \cdot 1 = 1 \neq 0$, A^{-1} exists. $A^{-1} = \frac{1}{1} \begin{pmatrix} 2 & -1 \\ -3 & 2 \end{pmatrix}$

Or $\left(\begin{array}{cc|cc} 2 & 1 & 1 & 0 \\ 3 & 2 & 0 & 1 \end{array} \right) \rightarrow \left(\begin{array}{cc|cc} 2 & 1 & 1 & 0 \\ 0 & \frac{1}{2} & -\frac{3}{2} & 1 \end{array} \right) \rightarrow \left(\begin{array}{cc|cc} 2 & 1 & 1 & 0 \\ 0 & 1 & -3 & 2 \end{array} \right)$

$\left(\begin{array}{cc|cc} 2 & 0 & 4 & -2 \\ 0 & 1 & -3 & 2 \end{array} \right) \rightarrow \left(\begin{array}{cc|cc} 1 & 0 & 2 & -1 \\ 0 & 1 & -3 & 2 \end{array} \right)$. So $A^{-1} = \begin{pmatrix} 2 & -1 \\ -3 & 2 \end{pmatrix}$.

2. Since $\det A = (-1) \cdot (-12) - 1 \cdot 12 = 0$, A is not invertible.

3. $\det A = 0 - 1 = -1 \neq 0$ $A^{-1} = (-1) \begin{pmatrix} 0 & -1 \\ -1 & 0 \end{pmatrix} = \begin{pmatrix} 0 & 1 \\ 1 & 0 \end{pmatrix}$

4. Since $\det A = 3 - 3 = 0$, A^{-1} does not exist.

5. A is not invertible since $\det A = ab - ba = 0$.

6. $\left(\begin{array}{ccc|ccc} 1 & 1 & 1 & 1 & 0 & 0 \\ 0 & 2 & 3 & 0 & 1 & 0 \\ 5 & 5 & 1 & 0 & 0 & 1 \end{array} \right) \rightarrow \left(\begin{array}{ccc|ccc} 1 & 1 & 1 & 1 & 0 & 0 \\ 0 & 1 & 3/2 & 0 & 1/2 & 0 \\ 0 & 0 & -4 & -5 & 0 & 1 \end{array} \right) \rightarrow \left(\begin{array}{ccc|ccc} 1 & 0 & -1/2 & 1 & -1/2 & 0 \\ 0 & 1 & 3/2 & 0 & 1/2 & 0 \\ 0 & 0 & 1 & 5/4 & 0 & -1/4 \end{array} \right)$
 $\rightarrow \left(\begin{array}{ccc|ccc} 1 & 0 & 0 & 13/8 & -1/2 & -1/8 \\ 0 & 1 & 0 & -15/8 & 1/2 & 3/8 \\ 0 & 0 & 1 & 5/4 & 0 & -1/4 \end{array} \right)$ $A^{-1} = \begin{pmatrix} 13/8 & -1/2 & -1/8 \\ -15/8 & 1/2 & 3/8 \\ 5/4 & 0 & -1/4 \end{pmatrix}$

7. $\left(\begin{array}{ccc|ccc} 3 & 2 & 1 & 1 & 0 & 0 \\ 0 & 2 & 2 & 0 & 1 & 0 \\ 0 & 0 & -1 & 0 & 0 & 1 \end{array} \right) \rightarrow \left(\begin{array}{ccc|ccc} 1 & 2/3 & 1/3 & 1/3 & 0 & 0 \\ 0 & 1 & 1 & 0 & 1/2 & 0 \\ 0 & 0 & 1 & 0 & 0 & 1 \end{array} \right) \rightarrow \left(\begin{array}{ccc|ccc} 1 & 0 & -1/3 & 1/3 & -1/3 & 0 \\ 0 & 1 & 1 & 0 & 1/2 & 0 \\ 0 & 0 & 1 & 0 & 0 & 1 \end{array} \right)$
 $\rightarrow \left(\begin{array}{ccc|ccc} 1 & 0 & 0 & 1/3 & -1/3 & -1/3 \\ 0 & 1 & 0 & 0 & 1/2 & 1 \\ 0 & 0 & 1 & 0 & 0 & -1 \end{array} \right)$ $A^{-1} = \begin{pmatrix} 1/3 & -1/3 & -1/3 \\ 0 & 1/2 & 1 \\ 0 & 0 & -1 \end{pmatrix}$

8. $\left(\begin{array}{ccc|ccc} 1 & 1 & 1 & 1 & 0 & 0 \\ 0 & 1 & 1 & 0 & 1 & 0 \\ 0 & 0 & 1 & 0 & 0 & 1 \end{array} \right) \rightarrow \left(\begin{array}{ccc|ccc} 1 & 0 & 0 & 1 & -1 & 0 \\ 0 & 1 & 0 & 0 & 1 & -1 \\ 0 & 0 & 1 & 0 & 0 & 1 \end{array} \right)$ $A^{-1} = \begin{pmatrix} 1 & -1 & 0 \\ 0 & 1 & -1 \\ 0 & 0 & 1 \end{pmatrix}$

9. $\left(\begin{array}{ccc|ccc} 1 & 6 & 2 & 1 & 0 & 0 \\ -2 & 3 & 5 & 0 & 1 & 0 \\ 7 & 12 & -4 & 0 & 0 & 1 \end{array} \right) \rightarrow \left(\begin{array}{ccc|ccc} 1 & 6 & 2 & 1 & 0 & 0 \\ 0 & 15 & 9 & 2 & 1 & 0 \\ 0 & -30 & -18 & -7 & 0 & 1 \end{array} \right) \rightarrow \left(\begin{array}{ccc|ccc} 1 & 6 & 2 & 1 & 0 & 0 \\ 0 & 1 & 0.6 & 0.1333 & 0.0667 & 0 \\ 0 & 0 & 0 & -3 & 2 & 1 \end{array} \right)$

A is not invertible.

10. $\left(\begin{array}{ccc|ccc} 3 & 1 & 0 & 1 & 0 & 0 \\ 1 & -1 & 2 & 0 & 1 & 0 \\ 1 & 1 & 1 & 0 & 0 & 1 \end{array} \right) \rightarrow \left(\begin{array}{ccc|ccc} 1 & -1 & 2 & 0 & 1 & 0 \\ 0 & 4 & -6 & 1 & -3 & 0 \\ 0 & 2 & -1 & 0 & -1 & 1 \end{array} \right) \rightarrow \left(\begin{array}{ccc|ccc} 1 & 0 & 1/2 & 1/4 & 1/4 & 0 \\ 0 & 1 & -3/2 & 1/4 & -3/4 & 0 \\ 0 & 0 & 2 & -1/2 & 1/2 & 1 \end{array} \right)$
 $\rightarrow \left(\begin{array}{ccc|ccc} 1 & 0 & 0 & 3/8 & 1/8 & -1/4 \\ 0 & 1 & 0 & -1/8 & -3/8 & 3/4 \\ 0 & 0 & 1 & -1/4 & 1/4 & 1/2 \end{array} \right)$ $A^{-1} = \begin{pmatrix} 3/8 & 1/8 & -1/4 \\ -1/8 & -3/8 & 3/4 \\ -1/4 & 1/4 & 1/2 \end{pmatrix}$

$$\begin{aligned}
 11. \quad & \left(\begin{array}{ccc|ccc} 2 & -1 & 4 & 1 & 0 & 0 \\ -1 & 0 & 5 & 0 & 1 & 0 \\ 19 & -7 & 3 & 0 & 0 & 1 \end{array} \right) \rightarrow \left(\begin{array}{ccc|ccc} 1 & 0 & -5 & 0 & -1 & 0 \\ 2 & -1 & 4 & 1 & 0 & 0 \\ 19 & -7 & 3 & 0 & 0 & 1 \end{array} \right) \rightarrow \left(\begin{array}{ccc|ccc} 1 & 0 & -5 & 0 & -1 & 0 \\ 0 & -1 & 14 & 1 & 2 & 0 \\ 0 & -7 & 98 & 0 & 19 & 1 \end{array} \right) \\
 & \rightarrow \left(\begin{array}{ccc|ccc} 1 & 0 & -5 & 0 & -1 & 0 \\ 0 & 1 & -14 & -1 & -2 & 0 \\ 0 & 0 & 0 & -7 & 5 & 1 \end{array} \right) \quad A \text{ is not invertible.}
 \end{aligned}$$

$$\begin{aligned}
 12. \quad & \left(\begin{array}{ccc|ccc} 1 & 2 & 3 & 1 & 0 & 0 \\ 1 & 1 & 2 & 0 & 1 & 0 \\ 0 & 1 & 2 & 0 & 0 & 1 \end{array} \right) \rightarrow \left(\begin{array}{ccc|ccc} 1 & 2 & 3 & 1 & 0 & 0 \\ 0 & 1 & 1 & 1 & -1 & 0 \\ 0 & 1 & 2 & 0 & 0 & 1 \end{array} \right) \rightarrow \left(\begin{array}{ccc|ccc} 1 & 0 & 1 & -1 & 2 & 0 \\ 0 & 1 & 1 & 1 & -1 & 0 \\ 0 & 0 & 1 & -1 & 1 & 1 \end{array} \right) \rightarrow \left(\begin{array}{ccc|ccc} 1 & 0 & 0 & 0 & 1 & -1 \\ 0 & 1 & 0 & 2 & -2 & -1 \\ 0 & 0 & 1 & -1 & 1 & 1 \end{array} \right) \\
 & A^{-1} = \begin{pmatrix} 0 & 1 & -1 \\ 2 & -2 & -1 \\ -1 & 1 & 1 \end{pmatrix}
 \end{aligned}$$

$$\begin{aligned}
 13. \quad & \left(\begin{array}{cccc|cccc} 1 & 1 & 1 & 1 & 1 & 0 & 0 & 0 \\ 1 & 2 & -1 & 2 & 0 & 1 & 0 & 0 \\ 1 & -1 & 2 & 1 & 0 & 0 & 1 & 0 \\ 1 & 3 & 3 & 2 & 0 & 0 & 0 & 1 \end{array} \right) \rightarrow \left(\begin{array}{cccc|cccc} 1 & 1 & 1 & 1 & 1 & 0 & 0 & 0 \\ 0 & 1 & -2 & 1 & -1 & 1 & 0 & 0 \\ 0 & -2 & 1 & 0 & -1 & 0 & 1 & 0 \\ 0 & 2 & 2 & 1 & -1 & 0 & 0 & 1 \end{array} \right) \rightarrow \left(\begin{array}{cccc|cccc} 1 & 0 & 3 & 0 & 2 & -1 & 0 & 0 \\ 0 & 1 & -2 & 1 & -1 & 1 & 0 & 0 \\ 0 & 0 & -3 & 2 & -3 & 2 & 1 & 0 \\ 0 & 0 & 6 & -1 & 1 & -2 & 0 & 1 \end{array} \right) \rightarrow \\
 & \left(\begin{array}{cccc|cccc} 1 & 0 & 0 & 2 & -1 & 1 & 1 & 0 \\ 0 & 1 & 0 & -1/3 & 1 & -1/3 & -2/3 & 0 \\ 0 & 0 & 1 & -2/3 & 1 & -2/3 & -1/3 & 0 \\ 0 & 0 & 0 & 3 & -5 & 2 & 2 & 1 \end{array} \right) \rightarrow \left(\begin{array}{cccc|cccc} 1 & 0 & 0 & 0 & 7/3 & -1/3 & -1/3 & -2/3 \\ 0 & 1 & 0 & 0 & 4/9 & -1/9 & -4/9 & 1/9 \\ 0 & 0 & 1 & 0 & -1/9 & -2/9 & 1/9 & 2/9 \\ 0 & 0 & 0 & 1 & -5/3 & 2/3 & 2/3 & 1/3 \end{array} \right) \\
 & A^{-1} = \begin{pmatrix} 7/3 & -1/3 & -1/3 & -2/3 \\ 4/9 & -1/9 & -4/9 & 1/9 \\ -1/9 & -2/9 & 1/9 & 2/9 \\ -5/3 & 2/3 & 2/3 & 1/3 \end{pmatrix}
 \end{aligned}$$

$$\begin{aligned}
 14. \quad & \left(\begin{array}{ccc|ccc} 1 & 0 & 2 & 3 & 1 & 0 & 0 & 0 \\ -1 & 1 & 0 & 4 & 0 & 1 & 0 & 0 \\ 2 & 1 & -1 & 3 & 0 & 0 & 1 & 0 \\ -1 & 0 & 5 & 7 & 0 & 0 & 0 & 1 \end{array} \right) \rightarrow \left(\begin{array}{ccc|ccc} 1 & 0 & 2 & 3 & 1 & 0 & 0 & 0 \\ 0 & 1 & 2 & 7 & 1 & 1 & 0 & 0 \\ 0 & 1 & -5 & -3 & -2 & 0 & 1 & 0 \\ 0 & 0 & 7 & 10 & 1 & 0 & 0 & 1 \end{array} \right) \rightarrow \left(\begin{array}{ccc|ccc} 1 & 0 & 2 & 3 & 1 & 0 & 0 & 0 \\ 0 & 1 & 2 & 7 & 1 & 1 & 0 & 0 \\ 0 & 0 & -7 & -10 & -3 & -1 & 1 & 0 \\ 0 & 0 & 0 & 0 & -2 & -1 & 1 & 1 \end{array} \right) \\
 & A \text{ is not invertible.}
 \end{aligned}$$

$$\begin{aligned}
 15. \quad & \left(\begin{array}{cccc|cccc} 1 & -3 & 0 & 2 & 1 & 0 & 0 & 0 \\ 3 & -12 & -2 & -6 & 0 & 1 & 0 & 0 \\ -2 & 10 & 2 & 5 & 0 & 0 & 1 & 0 \\ -1 & 6 & 1 & 3 & 0 & 0 & 0 & 1 \end{array} \right) \rightarrow \left(\begin{array}{cccc|cccc} 1 & -3 & 0 & -2 & 1 & 0 & 0 & 0 \\ 0 & -3 & -2 & 0 & -3 & 1 & 0 & 0 \\ 0 & 4 & 2 & 1 & 2 & 0 & 1 & 0 \\ 0 & 3 & 1 & 1 & 1 & 0 & 0 & 1 \end{array} \right) \\
 & \rightarrow \left(\begin{array}{cccc|cccc} 1 & 0 & 3/2 & -5/4 & 5/2 & 0 & 3/4 & 0 \\ 0 & 1 & 1/2 & 1/4 & 1/2 & 0 & 1/4 & 0 \\ 0 & 0 & -1/2 & 3/4 & -3/2 & 1 & 3/4 & 0 \\ 0 & 0 & -1/2 & 1/4 & -1/2 & 0 & -3/4 & 1 \end{array} \right) \rightarrow \left(\begin{array}{cccc|cccc} 1 & 0 & 0 & 1 & -2 & 3 & 3 & 0 \\ 0 & 1 & 0 & 1 & -1 & 1 & 1 & 0 \\ 0 & 0 & 1 & -3/2 & 3 & -2 & -3/2 & 0 \\ 0 & 0 & 0 & -1/2 & 1 & -1 & -3/2 & 1 \end{array} \right) \\
 & \rightarrow \left(\begin{array}{cccc|cccc} 1 & 0 & 0 & 0 & 0 & 1 & 0 & 2 \\ 0 & 1 & 0 & 0 & 1 & -1 & -2 & 2 \\ 0 & 0 & 1 & 0 & 0 & 1 & 3 & -3 \\ 0 & 0 & 0 & 1 & -2 & 2 & 3 & -2 \end{array} \right) \\
 & A^{-1} = \begin{pmatrix} 0 & 1 & 0 & 2 \\ 1 & -1 & -2 & 2 \\ 0 & 1 & 3 & -3 \\ -2 & 2 & 3 & -2 \end{pmatrix}
 \end{aligned}$$

16. $ABCC^{-1}B^{-1}A^{-1} = ABIB^{-1}A^{-1} = ABB^{-1}A^{-1} = AIA^{-1} = AA^{-1} = I$. Hence, by theorem 8, ABC is invertible and $(ABC)^{-1} = A^{-1}B^{-1}C^{-1}$.

17. Show $A_1A_2 \cdots A_m A_m^{-1} \cdots A_2^{-1}A_1^{-1} = I$. Then by theorem 8, $A_1A_2 \cdots A_m$ is invertible with inverse $A_m^{-1} \cdots A_2^{-1}A_1^{-1}$.

$$18. \begin{pmatrix} 3 & 4 \\ -2 & -3 \end{pmatrix} \begin{pmatrix} 3 & 4 \\ -2 & -3 \end{pmatrix} = \begin{pmatrix} 9-8 & 12-12 \\ -6+6 & -8+9 \end{pmatrix} = I$$

$$19. \text{ If } A = \pm I \text{ then } A^2 = I. \text{ If } a_{11} = -a_{22} \text{ and } a_{21}a_{12} = 1 - a_{11}^2 \text{ then } \begin{pmatrix} -a_{22} & a_{12} \\ a_{21} & a_{22} \end{pmatrix}^2 = \begin{pmatrix} a_{22}^2 + a_{12}a_{21} & -a_{22}a_{12} + a_{12}a_{22} \\ -a_{22}a_{21} + a_{22}a_{21} & a_{21}a_{12} + a_{22}^2 \end{pmatrix} = I$$

$$20. I - A = \begin{pmatrix} 4/5 & -1/5 & 0 \\ -2/5 & 3/5 & -3/5 \\ -1/5 & -1/10 & 3/5 \end{pmatrix} \quad (I - A)^{-1} = \begin{pmatrix} 1.7857 & 0.7143 & 0.7143 \\ 2.1492 & 2.8571 & 2.8571 \\ 0.9524 & 0.7143 & 2.3810 \end{pmatrix}$$

$$\mathbf{x} = (I - A)^{-1}\mathbf{e} \approx \begin{pmatrix} 96.4 \\ 235.7 \\ 138.1 \end{pmatrix}$$

21. $B\mathbf{x} = 0$ gives m equations in n unknowns. Since $m < n$, there are an infinite number of solutions. In particular, there exists a nonzero solution. Hence, there exists a nonzero vector \mathbf{x} such that $AB\mathbf{x} = 0$. By theorem 6, AB is not invertible.

$$22. (a) \det A = -i^2 - 2 = -1 \quad A^{-1} = -1 \begin{pmatrix} -i & -2 \\ -1 & i \end{pmatrix} = \begin{pmatrix} i & 2 \\ 1 & -i \end{pmatrix}$$

$$(b) \det A = 1 - i^2 = 2 \quad A^{-1} = \frac{1}{2} \begin{pmatrix} 1+i & 0 \\ 0 & 1-i \end{pmatrix} = \begin{pmatrix} (1+i)/2 & 0 \\ 0 & (1-i)/2 \end{pmatrix}$$

$$(c) \left(\begin{array}{ccc|ccc} 1 & i & 0 & 1 & 0 & 0 \\ -i & 0 & 1 & 0 & 1 & 0 \\ 0 & 1+i & 1-i & 0 & 0 & 1 \end{array} \right) \rightarrow \left(\begin{array}{ccc|ccc} 1 & i & 0 & 1 & 0 & 0 \\ 0 & 1 & -1 & -i & -1 & 0 \\ 0 & 1+i & 1-i & 0 & 0 & 1 \end{array} \right) \rightarrow \left(\begin{array}{ccc|ccc} 1 & 0 & i & 0 & i & 0 \\ 0 & 1 & -1 & -i & -1 & 0 \\ 0 & 0 & 2 & -1+i & 1+i & 1 \end{array} \right)$$

$$\rightarrow \left(\begin{array}{ccc|ccc} 1 & 0 & 0 & (1+i)/2 & (1+i)/2 & -i/2 \\ 0 & 1 & 0 & -(1+i)/2 & -(1+i)/2 & 1/2 \\ 0 & 0 & 1 & (-1+i)/2 & (1+i)/2 & 1/2 \end{array} \right) \quad A^{-1} = \begin{pmatrix} (1+i)/2 & (1+i)/2 & -i/2 \\ -(1+i)/2 & -(1+i)/2 & 1/2 \\ (-1+i)/2 & (1+i)/2 & 1/2 \end{pmatrix}$$

23. $\begin{pmatrix} \sin \theta & \cos \theta & 0 \\ \cos \theta & -\sin \theta & 0 \\ 0 & 0 & 1 \end{pmatrix}^2 = I$; this matrix is its own inverse. You can discover this by trying to do row elimination or by finding the inverse of the upper left 2×2 block using (12) in Theorem 4.

$$24. A^{-1} = \begin{pmatrix} 1/2 & 0 & 0 \\ 0 & 1/3 & 0 \\ 0 & 0 & 1/4 \end{pmatrix}, \text{ from } (A | I) \rightarrow (I | A^{-1}).$$

25. Let D be a diagonal matrix. Suppose D is invertible with inverse A . Since $AD = I$, then $a_{ii}d_{ii} = 1$ for each i . Hence, the diagonal components of D are nonzero. Conversely, suppose $d_{ii} \neq 0$ for each i . Then the only solution to $D\mathbf{x} = \mathbf{0}$ is the trivial solution. By theorem 6, D is invertible. Or you can write down D^{-1} directly as in Problem 26.

$$26. A^{-1} = \begin{pmatrix} a_{11}^{-1} & 0 & \cdots & 0 \\ 0 & a_{22}^{-1} & \cdots & 0 \\ \vdots & \vdots & \ddots & \vdots \\ 0 & 0 & \cdots & a_{nn}^{-1} \end{pmatrix}, \text{ from } (A | I) \rightarrow (I | A^{-1}).$$

$$27. \left(\begin{array}{ccc|ccc} 2 & 1 & -1 & 1 & 0 & 0 \\ 0 & 3 & 4 & 0 & 1 & 0 \\ 0 & 0 & 5 & 0 & 0 & 1 \end{array} \right) \rightarrow \left(\begin{array}{ccc|ccc} 1 & 0 & -7/6 & 1/2 & -1/6 & 0 \\ 0 & 1 & 4/3 & 0 & 1/3 & 0 \\ 0 & 0 & 5 & 0 & 0 & 1 \end{array} \right) \rightarrow \left(\begin{array}{ccc|ccc} 1 & 0 & 0 & 1/2 & -1/6 & 7/30 \\ 0 & 1 & 0 & 0 & 1/3 & -4/15 \\ 0 & 0 & 1 & 0 & 0 & 1/5 \end{array} \right)$$

$$A^{-1} = \begin{pmatrix} 1/2 & -1/6 & 7/30 \\ 0 & 1/3 & -4/15 \\ 0 & 0 & 1/5 \end{pmatrix}$$

$$28. \left(\begin{array}{ccc|ccc} 1 & 0 & 0 & 1 & 0 & 0 \\ -2 & 0 & 0 & 0 & 1 & 0 \\ 4 & 6 & 1 & 0 & 0 & 1 \end{array} \right) \rightarrow \left(\begin{array}{ccc|ccc} 1 & 0 & 0 & 1 & 0 & 0 \\ 4 & 6 & 1 & 0 & 0 & 1 \\ 0 & 0 & 0 & 2 & 1 & 0 \end{array} \right) \quad A \text{ does not have an inverse.}$$

29. If U is upper triangular with all diagonals nonzero, then divide each row by its diagonal entry. The result is an echelon form of U with n pivots. So by Theorem 6.v, U is invertible. Conversely, if U has some diagonal zero, let j be such that $u_{jj} = 0$ is the first zero on the diagonal. Then form $\mathbf{x} = (x_k)$, with $x_k = 0$ for $k > j$ and $x_j = 1$, but the $x_k, k < j$ unknown. Then the nonzero equations $U\mathbf{x} = \mathbf{0}$ formed from the first $j - 1$ rows of U and this \mathbf{x} can be backsolved to get the remaining x_k , since they have the form

$$a_{kk}x_k + \cdots + a_{kj} = 0, a_{kk} \neq 0, k < j.$$

Thus $U\mathbf{x} = \mathbf{0}$ has a nonzero solution and so U is not invertible.

30. Row reducing $(U | I)$ to $(I | U^{-1})$ requires only dividing through by the diagonals of U and then adding multiples of lower rows to higher rows, i.e. only backsolving is needed as U is already essentially in echelon form. But both these types of row operations only change the elements on or above the diagonal of the right hand block. Thus when this reduction is done $A = U^{-1}$ will be upper triangular. (You can also solve this using partitioned matrices. To get an idea look at the solution to Problem 49.)

$$31. \left(\begin{array}{cc|c} 2 & -1 & 0 \\ -4 & 2 & 0 \end{array} \right) \rightarrow \left(\begin{array}{cc|c} 1 & -1/2 & 0 \\ 0 & 0 & 0 \end{array} \right). \text{ If } \mathbf{x} = \begin{pmatrix} \frac{1}{2}x \\ x \end{pmatrix} \text{ then } A\mathbf{x} = \mathbf{0}. \text{ For example, } \begin{pmatrix} 1 \\ 2 \end{pmatrix} \text{ is one such vector.}$$

$$32. \left(\begin{array}{ccc|c} 1 & -1 & 3 & 0 \\ 0 & 4 & -2 & 0 \\ 2 & -6 & 8 & 0 \end{array} \right) \rightarrow \left(\begin{array}{ccc|c} 1 & 0 & 5/2 & 0 \\ 0 & 1 & -1/2 & 0 \\ 0 & 0 & 0 & 0 \end{array} \right). \text{ If } \mathbf{x} = \begin{pmatrix} -2.5x \\ 0.5x \\ x \end{pmatrix} \text{ then } A\mathbf{x} = \mathbf{0}. \text{ For example, } \begin{pmatrix} -5 \\ 1 \\ 2 \end{pmatrix} \text{ is such a vector.}$$

33. Let c be the number of chairs and t the number of tables produced each day. We have $8 \cdot 12 = 96$ labor hours per day in the machine shop. Hence, for the machine shop we must have $\frac{384}{17} \cdot c + \frac{240}{17} \cdot t = 96$. Similarly, $\frac{480}{17} \cdot c + \frac{640}{17} \cdot t = 8 \cdot 20 = 160$ for the assembly and finishing division. Write this system

$$\text{as } A\mathbf{x} = \mathbf{b} \text{ where } A = \begin{pmatrix} \frac{384}{17} & \frac{240}{17} \\ \frac{480}{17} & \frac{640}{17} \end{pmatrix}, \mathbf{x} = \begin{pmatrix} c \\ t \end{pmatrix}, \text{ and } \mathbf{b} = \begin{pmatrix} 96 \\ 160 \end{pmatrix}. \text{ Since } \det A = \frac{130,560}{289} \neq 0, \text{ then}$$

$$\mathbf{x} = A^{-1}\mathbf{b} = \frac{289}{130,560} \begin{pmatrix} \frac{640}{17} & \frac{240}{17} \\ \frac{480}{17} & \frac{384}{17} \end{pmatrix} \begin{pmatrix} 96 \\ 160 \end{pmatrix} = \begin{pmatrix} 3 \\ 2 \end{pmatrix}. \text{ Hence, 3 chairs and 2 tables can be produced}$$

each day.

34. Let l be the amount of love potion and c be the amount of cold remedy needed. The witch wants to

$$\text{find } \mathbf{x} = \begin{pmatrix} l \\ c \end{pmatrix} \text{ such that } A\mathbf{x} = \mathbf{b} \text{ where } A = \begin{pmatrix} 3\frac{1}{13} & 5\frac{5}{13} \\ 2\frac{2}{13} & 10\frac{10}{13} \end{pmatrix} \text{ and } \mathbf{b} = \begin{pmatrix} 10 \\ 14 \end{pmatrix}. \text{ Since } \det A = \frac{1}{169}(40 \cdot$$

$$140 - 28 \cdot 70) = \frac{280}{13} \neq 0, \text{ then } \mathbf{x} = A^{-1}\mathbf{b} = \frac{13}{280} \begin{pmatrix} \frac{140}{13} & \frac{70}{13} \\ \frac{28}{13} & \frac{40}{13} \end{pmatrix} \begin{pmatrix} 10 \\ 14 \end{pmatrix} = \begin{pmatrix} 3/2 \\ 1 \end{pmatrix}. \text{ Hence, } 1\frac{1}{2} \text{ batches}$$

of love potion and 1 batch of cold remedy are needed.

35. The farmer needs $A\mathbf{x} = \mathbf{b}$ where $A = \begin{pmatrix} 0.10 & 0.12 \\ 0.15 & 0.08 \end{pmatrix}$, $\mathbf{x} = \begin{pmatrix} a \\ b \end{pmatrix}$, and $\mathbf{b} = \begin{pmatrix} 1 \\ 1 \end{pmatrix}$. Since $\det A = -0.01 \neq 0$ then $\mathbf{x} = A^{-1}\mathbf{b} = -100 \begin{pmatrix} 0.08 & -0.12 \\ -0.15 & 0.10 \end{pmatrix} \begin{pmatrix} 1 \\ 1 \end{pmatrix} = \begin{pmatrix} 4 \\ 5 \end{pmatrix}$. Thus, 4 units of type A and 5 units of type B are needed.

36. (a) 0.293 (b) $200,000 \cdot 0.293 = 58,600$ (c) 0
(d) $50,000 \cdot 0.044 = 2,200$

37. (a) technology matrix $A = \begin{pmatrix} 0.293 & 0 & 0 \\ 0.014 & 0.207 & 0.017 \\ 0.044 & 0.010 & 0.216 \end{pmatrix}$

$$\text{Leontief matrix} = I - A = \begin{pmatrix} 0.707 & 0 & 0 \\ -0.014 & 0.793 & -0.017 \\ -0.044 & -0.010 & 0.784 \end{pmatrix}$$

(b) $(I - A)^{-1} = \begin{pmatrix} 1.414 & 0 & 0 \\ 0.027 & 1.261 & 0.027 \\ 0.080 & 0.016 & 1.276 \end{pmatrix}$ $\mathbf{x} = (I - A)^{-1} \begin{pmatrix} 13,213 \\ 17,597 \\ 1,786 \end{pmatrix} = \begin{pmatrix} 18,689 \\ 22,598 \\ 3,615 \end{pmatrix}$

It would require 18,689 pounds of agricultural products, 22,598 pounds of manufactured goods, and 3,615 pounds of energy.

$$38. \begin{pmatrix} 1 & 0 \\ 0 & 1 \end{pmatrix} \text{ invertible} \qquad 39. \begin{pmatrix} 2 & 1 \\ 3 & 2 \end{pmatrix} \rightarrow \begin{pmatrix} 1 & 1/2 \\ 0 & 1 \end{pmatrix} \text{ invertible}$$

$$40. \begin{pmatrix} 1 & 1 \\ 3 & 3 \end{pmatrix} \rightarrow \begin{pmatrix} 1 & 1 \\ 0 & 0 \end{pmatrix} \text{ not invertible}$$

$$41. \begin{pmatrix} 3 & 2 & 1 \\ 0 & 2 & 2 \\ 0 & 0 & -1 \end{pmatrix} \rightarrow \begin{pmatrix} 1 & 2/3 & 1/3 \\ 0 & 1 & 1 \\ 0 & 0 & 1 \end{pmatrix} \text{ invertible}$$

$$42. \begin{pmatrix} 1 & 6 & 2 \\ -2 & 3 & 5 \\ 7 & 12 & -4 \end{pmatrix} \rightarrow \begin{pmatrix} 1 & 6 & 2 \\ 0 & 15 & 9 \\ 0 & -30 & -18 \end{pmatrix} \rightarrow \begin{pmatrix} 1 & 6 & 2 \\ 0 & 1 & 3/5 \\ 0 & 0 & 0 \end{pmatrix} \text{ not invertible}$$

$$43. \begin{pmatrix} 2 & -1 & 4 \\ -1 & 0 & 5 \\ 19 & -7 & 3 \end{pmatrix} \rightarrow \begin{pmatrix} 1 & -1/2 & 2 \\ 0 & 1 & -14 \\ 0 & 0 & 0 \end{pmatrix} \text{ not invertible}$$

$$44. \begin{pmatrix} 1 & 1 & 1 & 1 \\ 1 & 2 & -1 & 2 \\ 1 & -1 & 2 & 1 \\ 1 & 3 & 3 & 2 \end{pmatrix} \rightarrow \begin{pmatrix} 1 & 1 & 1 & 1 \\ 0 & 1 & -2 & 1 \\ 0 & 0 & -3 & 2 \\ 0 & 0 & 6 & -1 \end{pmatrix} \rightarrow \begin{pmatrix} 1 & 1 & 1 & 1 \\ 0 & 1 & -2 & 1 \\ 0 & 0 & 1 & -2/3 \\ 0 & 0 & 0 & 1 \end{pmatrix} \text{ invertible}$$

$$45. \begin{pmatrix} 1 & 0 & 2 & 3 \\ -1 & 1 & 0 & 4 \\ 2 & 1 & -1 & 3 \\ -1 & 0 & 5 & 7 \end{pmatrix} \rightarrow \begin{pmatrix} 1 & 0 & 2 & 3 \\ 0 & 1 & 2 & 7 \\ 0 & 0 & 1 & 10/7 \\ 0 & 0 & 0 & 0 \end{pmatrix} \text{ not invertible}$$

46. Since $a_{11}a_{22} - a_{12}a_{21} \neq 0$, then either a_{11} or a_{12} is nonzero. We may assume without loss of generality that $a_{11} \neq 0$.

$$\begin{aligned} \left(\begin{array}{cc|cc} a_{11} & a_{12} & 1 & 0 \\ a_{21} & a_{22} & 0 & 1 \end{array} \right) &\rightarrow \left(\begin{array}{cc|cc} 1 & a_{12}/a_{11} & 1/a_{11} & 0 \\ 0 & a_{22} - a_{12}a_{21}/a_{11} & -a_{21}/a_{11} & 1 \end{array} \right) \\ &\rightarrow \left(\begin{array}{cc|cc} 1 & 0 & a_{22}/\det A & -a_{21}/\det A \\ 0 & 1 & -a_{21}/\det A & a_{11}/\det A \end{array} \right) \end{aligned}$$

47. (i) Suppose A is invertible. Then $A\mathbf{x} = \mathbf{0}$ implies $\mathbf{x} = A^{-1}\mathbf{0} = \mathbf{0}$. When reducing the augmented matrix $(A|\mathbf{0})$ to reduced row echelon form, we must have $(A|\mathbf{0}) \rightarrow (I|\mathbf{0})$. Using the same elementary row operations will give $A \rightarrow I$. Conversely, suppose A is row equivalent to I . Write $(A|I)$ and row reduce A to I . Then we will have $(A|I) \rightarrow (I|B)$. Hence, $AB = I$. We want to show $BA = I$. It will suffice to show $BAX = \mathbf{x}$ for every n -vector \mathbf{x} . Note that B is row equivalent to I . Hence, for every \mathbf{x} , we can find a \mathbf{y} such that $B\mathbf{y} = \mathbf{x}$. Thus, $BAX = BA(B\mathbf{y}) = B(AB)\mathbf{y} = BI\mathbf{y} = B\mathbf{y} = \mathbf{x}$. Therefore, A is invertible.

(ii) Suppose A is invertible. Suppose $A\mathbf{x} = \mathbf{b} = A\mathbf{y}$. Multiplying by A^{-1} we obtain $A^{-1}(A\mathbf{x}) = A^{-1}(A\mathbf{y})$. It follows that $\mathbf{x} = \mathbf{y}$. Conversely, suppose the system $A\mathbf{x} = \mathbf{b}$ has a unique solution for every n -vector \mathbf{b} . This implies A is row equivalent to I . Therefore, by part (i), A is invertible.

(iv) Suppose A is invertible. By (i) A is row equivalent to the identity matrix I_n . I_n is in row echelon form and has n -pivots. Conversely, suppose that an echelon form of A has n pivots. Then the reduced echelon form of A is the identity matrix I_n . Thus A is row equivalent to the identity matrix I_n . By (i) A is invertible.

48. From $\begin{pmatrix} I & A \\ O & I \end{pmatrix} \begin{pmatrix} A_{11} & A_{12} \\ A_{21} & A_{22} \end{pmatrix} = \begin{pmatrix} I & O \\ O & I \end{pmatrix}$ we obtain the following equations:

$$A_{11} + AA_{21} = I, A_{12} + AA_{22} = 0, A_{21} = 0 \text{ and } A_{22} = I.$$

Solving for A_{11} and A_{12} we get $A_{11} = I$ and $A_{12} = -A$.

$$\text{Thus } \begin{pmatrix} I & A \\ O & I \end{pmatrix}^{-1} = \begin{pmatrix} I & -A \\ O & I \end{pmatrix}.$$

49. From $\begin{pmatrix} A_{11} & O \\ A_{21} & A_{22} \end{pmatrix} \begin{pmatrix} B_{11} & B_{12} \\ B_{21} & B_{22} \end{pmatrix} = \begin{pmatrix} I & O \\ O & I \end{pmatrix}$ we obtain the following equations: $A_{11}B_{11} = I$, $A_{11}B_{12} = O$, $A_{21}B_{11} + A_{22}B_{21} = O$ and $A_{21}B_{12} + A_{22}B_{22} = I$. Solving for the B_{ij} we get

$$B_{11} = A_{11}^{-1}, B_{12} = O, B_{21} = A_{22}^{-1}(-A_{21}A_{11}^{-1}) \text{ and } B_{22} = A_{22}^{-1}.$$

$$\text{Thus } \begin{pmatrix} A_{11} & O \\ A_{21} & A_{22} \end{pmatrix}^{-1} = \begin{pmatrix} A_{11}^{-1} & O \\ A_{22}^{-1}(-A_{21}A_{11}^{-1}) & A_{22}^{-1} \end{pmatrix}.$$

CALCULATOR SOLUTIONS 1.8

The solution for Problem nn assumes the data has been entered into the matrix A18nn.

50. The inverse of A1850, calculated by A1850 $\boxed{2nd}$ $\boxed{x^{-1}}$ \boxed{ENTER} is

```
[ [ .099858156028  -.076501182033  -.076312056738  ]
  [ -.101843971631  .272151300236  -.192056737589  ] .
  [ .143262411348  -.067139479905  .075177304965  ] ]
```

51. The inverse A1851, calculated by A1851 $\boxed{2nd}$ $\boxed{x^{-1}}$ \boxed{ENTER} is

```
[ [ -1.40754039497  .456014362657  .303411131059  ]
  [ .657091561939  -.166965888689  -.154398563734  ] .
  [ .439856373429  -.26750448833  -.03231597846  ] ]
```

52. The inverse of A1852, calculated by A1852 $\boxed{2nd}$ $\boxed{x^{-1}}$ \boxed{ENTER} is

```
[ [ -1.69701053654  1.60958317276  2.30794647641  1.41376091667  ]
  [ -.793941492883  1.67786019382  .951949895801  .261501231662  ]
  [ 1.95621257025  -.200637557471  -.462876267722  .357416829406  ]
  [ -.654423076042  .641726876009  -.249248482807  .536103553562  ] ]
```

53. The inverse A1853, calculated by A1853 $\boxed{2nd}$ $\boxed{x^{-1}}$ \boxed{ENTER} is

```
[ [ .03984485542  .00954069806  .035197499863  .010590297574  ]
  [ -.003683920834  .00460111628  4.2629849506E-4  -.005608453127  ]
  [ .018345358489  .009413418129  .008529325192  .00297300599  ]
  [ .019410170095  .007025671643  .025503332841  .015762697722  ] ]
```

54. The inverse of A1854, calculated by A1854 $\boxed{2nd}$ $\boxed{x^{-1}}$ \boxed{ENTER} is

```
[ [ .333333333333  -.208333333333  1.675  -1.42142857143  ]
  [ 0  .125  -.325  .578571428571  ]
  [ 0  0  .2  -.114285714286  ]
  [ 0  0  0  -.142857142857  ] ]
```

which has zeros below the diagonal.

55. The inverse of A1855, calculated by A1855 $\boxed{2nd}$ $\boxed{x^{-1}}$ \boxed{ENTER} is

```
[ [ .04329004329  -.125690401552  -.196440007897  .126871293496  .203412258426  ]
  [ 0  -.068965517241  -.067111605488  .035660968327  .113274788336  ]
  [ 0  0  -.02688172043  .019100169779  .007849426165  ]
  [ 0  0  0  .010964912281  -.003226349456  ]
  [ 0  0  0  0  0  .02132196162  ] ]
```

which has zeros below the diagonal.

56. The results in Problem 54 and 55 suggest that the inverse of an upper triangular matrix is upper triangular.

MATLAB 1.8

1. (a) (i)

```
>> A = [1 2 3; 2 5 4; 1 -1 10];
>> R = [A eye(3)]
R =
     1     2     3     1     0     0
     2     5     4     0     1     0
     1    -1    10     0     0     1

>> rref(R)
ans =
     1     0     0    54   -23   -7
     0     1     0   -16     7     2
     0     0     1    -7     3     1

>> S = ans(:, [4:6])
S =
    54   -23   -7
   -16     7     2
    -7     3     1
```

(ii)

```
>> S*A
ans =
     1     0     0
     0     1     0
     0     0     1

>> A*S
ans =
     1     0     0
     0     1     0
     0     0     1
```

Both SA and AS are the identity matrix. Hence, S is the inverse of A .

(iii)

```
>> inv(A)
ans =
    54.0000   -23.0000   -7.0000
   -16.0000     7.0000     2.0000
    -7.0000     3.0000     1.0000
```

This seems to be the same as S although $S - \text{inv}(A)$ may not be exactly zero due to round off. The command `inv(A)` computes the inverse of the matrix A .

(b)

```
>> A = 2*rand(5)-1
A =
    0.8206   -0.3435   -0.5059   -0.8546    0.5330
    0.5244    0.2653    0.9651    0.2633   -0.0445
   -0.4751    0.5128    0.4453    0.7694   -0.5245
   -0.9051    0.9821    0.5067   -0.4546   -0.4502
    0.4722   -0.2693    0.3030   -0.1272   -0.2815
```

```

>> R = [A eye(5)];
>> rref(R)
ans =
Columns 1 through 7
    1.0000         0         0         0         0     1.6785     0.1073
         0     1.0000         0         0         0     2.0062     0.1332
         0         0     1.0000         0         0    -1.5142     0.9549
         0         0         0     1.0000         0     0.0574     0.1234
         0         0         0         0     1.0000    -0.7602     1.0249
Columns 8 through 10
    1.7333    -0.2542     0.3383
    2.2202     0.2963    -0.8329
   -1.8634     0.2153     0.1091
    0.8678    -0.6154    -0.5434
   -1.6150    -0.2000    -1.8254

>> S = ans(:, [6:10])
S =
    1.6785     0.1073     1.7333    -0.2542     0.3383
    2.0062     0.1332     2.2202     0.2963    -0.8329
   -1.5142     0.9549    -1.8634     0.2153     0.1091
    0.0574     0.1234     0.8678    -0.6154    -0.5434
   -0.7602     1.0249    -1.6150    -0.2000    -1.8254

>> A*S
ans =
    1.0000         0     0.0000     0.0000     0.0000
    0.0000     1.0000     0.0000     0.0000     0.0000
    0.0000     0.0000     1.0000     0.0000     0.0000
    0.0000     0.0000     0.0000     1.0000     0.0000
    0.0000     0.0000     0.0000     0.0000     1.0000

>> S*A
ans =
    1.0000     0.0000     0.0000     0.0000     0.0000
    0.0000     1.0000     0.0000     0.0000     0.0000
    0.0000     0.0000     1.0000     0.0000     0.0000
    0.0000     0.0000     0.0000     1.0000     0.0000
    0.0000     0.0000     0.0000     0.0000     1.0000

>> inv(A) - S % This should be zero up to round off error.
ans =
    1.0e-15 *
   -0.4441     0.1943         0     0.3886    -0.2220
         0    -0.0278         0     0.4996    -0.1110
   -0.2220    -0.1110         0    -0.1943     0.1943
    0.0278    -0.0416     0.1110         0         0
    0.1110    -0.2220     0.2220    -0.1388     0.2220

```

2. (i)

```

>> A = (1/13)* [2 7 5; 0 9 8; 7 4 0];

>> rref(A) % part (a)
ans =
     1     0     0
     0     1     0
     0     0     1

>> B = inv(A) % This will exist since there are no zero rows above
B =
   -32.0000    20.0000    11.0000
    56.0000   -35.0000   -16.0000
   -63.0000    41.0000    18.0000

>> % For part (c):
>> A*B % This should be I.
ans =
     1.0000     0.0000     0.0000
         0     1.0000     0.0000
         0     0.0000     1.0000

>> B*A % This should also be I.
ans =
     1.0000     0.0000         0
         0     1.0000     0.0000
         0     0.0000     1.0000

>> b = 2*rand(3,1) - 1 % Choose a random b, with 3 rows.
b =
     0.0090
     0.0326
    -0.3619

>> rref([A b]) % Solve Ax=b.
ans =
     1.0000         0         0    -3.6191
         0     1.0000         0     5.1571
         0         0     1.0000    -5.7488

>> x = ans(:,4); % Set x equal to the solution.
>> y = inv(A)*b % Solve Ax=b using inverses.
y =
    -3.6191
     5.1571
    -5.7488

>> x-y % This should be zero up to round off error.
ans =
    1.0e-15 *
     0.4441
     0.8882
    -0.8882

```

(ii)

```

>> A = [2 -4 5; 0 0 8; 7 -14 0];
>> rref(A) % part (a)
ans =
     1     -2     0
     0      0     1
     0      0     0

>> B = inv(A) % This will not exist since there are zero rows above.
Warning: Matrix is singular to working precision.
B =
     Inf     Inf     Inf
     Inf     Inf     Inf
     Inf     Inf     Inf

>> % For part (b): "singular" means that the matrix is not invertible.

```

(iii)

```

>> A = [1 4 -2 1; 5 1 9 7; 7 4 10 4; 0 7 -7 7];
>> rref(A) % part (a)
ans =
     1     0     2     0
     0     1    -1     0
     0     0     0     1
     0     0     0     0

>> B = inv(A) % This will not exist since there are zero rows above.
Warning: Matrix is close to singular or badly scaled.
Results may be inaccurate. RCOND = 7.178166e-18
B =
 1.0e+15 *
 -3.6029  -1.8014   1.8014   1.2867
  1.8014   0.9007  -0.9007  -0.6434
  1.8014   0.9007  -0.9007  -0.6434
  0.0000         0   0.0000   0.0000

```

For part (b): From the command `rref`, we see that A is actually singular. However, MATLAB gives us an answer since round off error during the computation makes A seem to be invertible. However, MATLAB gives a warning since it could tell “nonsingularity” might be due to round off error.

(iv)

```

>> A = [1 4 6 1; 5 1 9 7; 7 4 8 4; 0 7 5 7];
>> rref(A) % part (a)
ans =
     1     0     0     0
     0     1     0     0
     0     0     1     0
     0     0     0     1

>> B = inv(A) % This will exist since there are no zero rows.
B =
 -0.1558  -0.0779   0.2208  -0.0260
  0.0115  -0.1609   0.1133   0.0945
  0.2121   0.1061  -0.1061  -0.0758
 -0.1631   0.0851  -0.0375   0.1025

```

```

>> % For part (c):
>> A*B % This should be I.
ans =
    1.0000    0.0000    0.0000    0.0000
         0    1.0000    0.0000    0.0000
    0.0000         0    1.0000    0.0000
    0.0000    0.0000         0    1.0000

>> B*A % This should also be I.
ans =
    1.0000    0.0000    0.0000    0.0000
         0    1.0000    0.0000         0
         0         0    1.0000    0.0000
    0.0000    0.0000    0.0000    1.0000

>> b = 2*rand(4,1) - 1 % Choose a random b.
b =
    0.9733
   -0.0120
   -0.4677
   -0.8185

>> rref([A b]) % Solve Ax=b.
ans =
    1.0000         0         0         0   -0.2327
         0    1.0000         0         0   -0.1172
         0         0    1.0000         0    0.3168
         0         0         0    1.0000   -0.2260

>> x = ans(:,5); % Set x equal to the solution.
>> y = inv(A)*b % Solve Ax=b using inverses.
y =
   -0.2327
   -0.1172
    0.3168
   -0.2260

>> x-y % This should be zero up to round off error.
ans =
    1.0e-16 *
         0
   -0.5551
         0
    0.2776

```

(v)

```

>> A = (-1/56) * [1 2 3 4 5
                  0 -1 2 -1 2
                  1 0 0 2 -1
                  1 1 -1 1 1
                  0 0 0 0 4];

```

```

>> rref(A) % part (a)
ans =
    1    0    0    0    0
    0    1    0    0    0
    0    0    1    0    0
    0    0    0    1    0
    0    0    0    0    1

>> B = inv(A) % This will exist since there are no zero rows above.
B =
    8.0000   -40.0000   -8.0000   -56.0000    22.0000
   -12.0000    4.0000    40.0000   -28.0000    30.0000
   -8.0000   -16.0000    8.0000    0.0000    20.0000
   -4.0000    20.0000   -24.0000    28.0000   -18.0000
    0.0000    0.0000    0.0000    0.0000   -14.0000

>> % For part (c):
>> A*B % This should be I.
ans =
    1.0000    0.0000    0.0000    0.0000    0.0000
    0.0000    1.0000    0.0000    0.0000    0.0000
    0.0000    0.0000    1.0000    0.0000    0.0000
    0.0000    0.0000    0.0000    1.0000    0.0000
    0.0000    0.0000    0.0000    0.0000    1.0000

>> B*A % This should also be I.
ans =
    1.0000    0.0000    0.0000    0.0000    0.0000
    0.0000    1.0000    0.0000    0.0000    0.0000
    0.0000    0.0000    1.0000    0.0000    0.0000
    0.0000    0.0000    0.0000    1.0000    0.0000
    0.0000    0.0000    0.0000    0.0000    1.0000

>> b = 2*rand(5,1) - 1 % Choose a random b.
b =
    0.5230
    0.5404
    0.6556
   -0.7493
   -0.9683

>> rref([A b]) % Solve Ax=b.
ans =
    1.0000    0.0000    0.0000    0.0000    0.0000   -2.0200
    0.0000    1.0000    0.0000    0.0000    0.0000   14.0423
    0.0000    0.0000    1.0000    0.0000    0.0000  -26.9510
    0.0000    0.0000    0.0000    1.0000    0.0000 -10.5699
    0.0000    0.0000    0.0000    0.0000    1.0000   13.5557

>> x = ans(:,6); % Set x equal to the solution.
>> y = inv(A)*b % Solve Ax=b using inverses.
y =
   -2.0200
   14.0423
  -26.9510
  -10.5699
   13.5557

```

```

>> x-y          % This should be zero up to round off error.
ans =
  1.0e-13 *
  -0.1066
   0.0355
   0
   0
   0.0178

>> A = [ 1 2 -1 7 5          % Matrix for (vi)
         0 -1 2 -3 2
         1 0 3 1 -1
         1 1 1 4 1
         0 0 0 0 4 ];

>> rref(A) % part (a)
ans =
   1         0         3         1         0
   0         1        -2         3         0
   0         0         0         0         1
   0         0         0         0         0
   0         0         0         0         0

>> B = inv(A) % This will not exist since there are zero rows.
Warning: Matrix is singular to working precision.
B =
   Inf   Inf   Inf   Inf   Inf
   Inf   Inf   Inf   Inf   Inf
   Inf   Inf   Inf   Inf   Inf
   Inf   Inf   Inf   Inf   Inf
   Inf   Inf   Inf   Inf   Inf

>> % This is the same warning as in (ii).

```

3. (a)

```

>> A = round(10*(2*rand(5)-1))
A =
   4   10   0   -5   -6
   7    8   2   -2   -7
   3   -5   7    1    1
   5   -4  -2   -1    6
   5   -3   7   -4   -9

>> B = A;
>> B(3,:) = 3*B(1,:) + 5*B(2,:)
B =
   1    8    4   -2   -6
   0    2   -7   -9   -4
   3   34  -23  -51  -38
   5   -7   -5    9    3
   1   -6  -10   -5   -7

```

```
>> rref(B)
ans =
    1.0000    0    0    0   -6.8037
    0    1.0000    0    0    3.2398
    0    0    1.0000    0   -4.1014
    0    0    0    1.0000    4.3544
    0    0    0    0    0
```

Since the bottom row of the reduced matrix is zero, B will not be invertible.

(b)

```
>> B = A;
>> B(4,:) = 2*B(2,:) - B(1,:);
B =
    1    8    4   -2   -6
    0    2   -7   -9   -4
    9    7   -8    4    8
   -1   -4  -18  -16   -2
    1   -6  -10   -5   -7

>> rref(B)
ans =
    1.0000    0    0    0   -6.6780
    0    1.0000    0    0    3.0199
    0    0    1.0000    0   -3.8251
    0    0    0    1.0000    4.0906
    0    0    0    0    0
```

Again, the bottom row is zero, so B is not invertible.

- (c) Assume that row i is a linear combination of the other rows. Since one of the valid operations in Gaussian Elimination is to add a multiple of one row to another, we may subtract this linear combination of the other rows from row i . This will leave a matrix with zeros in row i . By rearranging the rows, we may put this zero row at the bottom. After continuing the Gaussian Elimination, this bottom row will still be zero, so the matrix will be singular.

4.

```
>> A = round(10*(2*rand(7)-1))
A =
    4    2    1   -4    0    9   -3
   -2    9   -5    3   -2   -2   -5
   -2    1    0   -7   -6   -7   -7
    0   -7   -1    3   -9    8    6
   -7   10    9    2    8   -8   -1
    2   -2   -7    6   -1   -7   -3
    7   -7   -6   -5   -7   -9   -1

>> B = A;
>> B(:,3) = 2*B(:,1) - B(:,2);
B =
    4    2    6   -4    0    9   -3
   -2    9  -13    3   -2   -2   -5
   -2    1   -5   -7   -6   -7   -7
    0   -7    7    3   -9    8    6
   -7   10  -24    2    8   -8   -1
    2   -2    6    6   -1   -7   -3
    7   -7   21   -5   -7   -9   -1
```

```

>> C = A;
>> C(:,4) = C(:,1)+C(:,2)-C(:,3);
>> C(:,6) = 3*C(:,2)
C =
     4     2     1     5     0     6    -3
    -2     9    -5    12    -2    27    -5
    -2     1     0     -1    -6     3    -7
     0    -7    -1    -6    -9   -21     6
    -7    10     9    -6     8    30    -1
     2    -2    -7     7    -1    -6    -3
     7    -7    -6     6    -7   -21    -1

>> D = A;
>> D(:,2) = 3*D(:,1);
>> D(:,4) = 2*D(:,1)-D(:,2)+4*D(:,3);
>> D(:,5) = D(:,2) - 5*D(:,3)
D =
     4    12     1     0     7     9    -3
    -2    -6    -5   -18    19    -2    -5
    -2    -6     0     2    -6    -7    -7
     0     0    -1    -4     5     8     6
    -7   -21     9    43   -66    -8    -1
     2     6    -7   -30    41    -7    -3
     7    21    -6   -31    51    -9    -1

>> rref(B)
ans =
     1     0     2     0     0     0     0
     0     1    -1     0     0     0     0
     0     0     0     1     0     0     0
     0     0     0     0     1     0     0
     0     0     0     0     0     1     0
     0     0     0     0     0     0     1
     0     0     0     0     0     0     0

>> rref(C)
ans =
     1     0     0     1     0     0     0
     0     1     0     1     0     3     0
     0     0     1    -1     0     0     0
     0     0     0     0     1     0     0
     0     0     0     0     0     0     1
     0     0     0     0     0     0     0
     0     0     0     0     0     0     0

>> rref(D)
ans =
     1     3     0    -1     3     0     0
     0     0     1     4    -5     0     0
     0     0     0     0     0     1     0
     0     0     0     0     0     0     1
     0     0     0     0     0     0     0
     0     0     0     0     0     0     0
     0     0     0     0     0     0     0

```

Each `rref` has a row of zeros so the original matrices are not invertible. So we conjecture any matrix with some columns equal to linear combinations of other columns will not be invertible.

- (b) Repeat with your own E . (The example $E = A$; $E(:,3) = 3*E(:,2)$; $E(:,4) = 2*E(:,1) + 4*E(:,3)$ is interesting.)
- (c) If column j of A is a linear combination of columns preceding it, then there will be no pivot in column j of $\text{rref}(A)$, and the non-zero entries in column j of $\text{rref}(A)$ may be the coefficients in the linear combination which represents the j th column. For instance column 4 in $\text{rref}(D)$ has -1 in row 1, 4 in row 2 and $D(:,4) = -1D(:,1) + 4D(:,2)$. (However, for the E suggested in (b), $\text{rref}(E)$ will not recover the (2,4) coefficients for column 4 since column 3 will not be a pivot column.)
- (d) This is the converse of Problem 5, Section 1.7. There we saw that if column j of $\text{rref}(A)$ had no pivot, then column j of A is a linear combination of the preceding (pivot) columns of A with coefficients given by the entries in column j of $\text{rref}(A)$.

5. (a) (i)

```
>> A = triu( round(10*(2*rand(5)-1)) );
>> A(2,2) = 0
A =
    1    -1    -1    -7     5
    0     0     6     3     5
    0     0    -3     2    -4
    0     0     0   -10    -2
    0     0     0     0     4
```

```
>> rref(A) % part (i)
ans =
    1    -1     0     0     0
    0     0     1     0     0
    0     0     0     1     0
    0     0     0     0     1
    0     0     0     0     0
```

Since the bottom row is zero, A is not invertible. This can be repeated 4 more times. In general, if A is upper triangular, and there is a zero on the diagonal, A will not be invertible. However, if there is not a zero, it will be invertible:

```
>> A = triu( round(10*(2*rand(5)-1)) )
A =
   -6    -2    10     3     3
    0     2    -5     4     3
    0     0    -5     6    -9
    0     0     0     4     2
    0     0     0     0    -5

>> rref(A)
ans =
    1     0     0     0     0
    0     1     0     0     0
    0     0     1     0     0
    0     0     0     1     0
    0     0     0     0     1
```

This matrix is invertible.

(ii)

```
>> B = inv(A) % part (ii)
B =
   -0.1667   -0.1667   -0.1667    0.5417    0.3167
         0    0.5000   -0.5000    0.2500    1.3000
         0         0   -0.2000    0.3000    0.4800
         0         0         0    0.2500    0.1000
         0         0         0         0   -0.2000
```

The inverse of an upper triangular matrix is also upper triangular. Also, if the diagonal entries of A are a_{ii} , then the diagonal entries of A^{-1} will be $1/a_{ii}$. Since one of the diagonal entries in (i) was 0, the matrix will not be invertible since $1/0$ is not defined.

(iii) Part (iii): To reduce the matrix $[A \ I]$ to echelon form, we would divide row one by a , row two by d , and row three by f . After this step, we would have $1/a$, $1/d$, and $1/f$ on the diagonal of the right hand side. We would then add multiples of row three to rows one and two, which will not change the diagonal on the right. Finally, we would add a multiple of row two to row one, which again will not change the diagonal on the right. This will leave the I on the left, and A^{-1} on the right. As predicted in (ii) the diagonal entries of A^{-1} are the inverses of those in A . Also, as predicted in (i), the first step of this process will fail if a , d , or f is zero. (See the solution to Problem 29.)

(b)

```
>> A = [1 2 3; 4 5 6; 7 8 9];
>> rref(A)
ans =
     1     0    -1
     0     1     2
     0     0     0
```

A is not invertible.

```
>> B = [1 2 3 4; 5 6 7 8; 9 10 11 12; 13 14 15 16];
>> rref(B)
ans =
     1     0    -1    -2
     0     1     2     3
     0     0     0     0
     0     0     0     0
```

B is also not invertible. In general, a matrix of this form will not be invertible. If $C = (c_{ij})$ is an $n \times n$ matrix with $c_{ij} = j + (i-1)n$, then $c_{3j} = 2 * c_{2j} - 1 * c_{1j}$. This means that the third row is 2 times the second row minus the first row.

(c) The assertion that there is a unique n th degree polynomial that fits $n + 1$ points is the same as saying that the coefficient matrix is invertible.

```
>> x = 2*rand(5,1)-1
x =
   -0.2330
    0.0388
    0.6619
   -0.9309
   -0.8931
```



```

>> V= vander(x)
V =
    0.0029   -0.0126    0.0543   -0.2330    1.0000
    0.0000    0.0001    0.0015    0.0388    1.0000
    0.1920    0.2900    0.4382    0.6619    1.0000
    0.7508   -0.8066    0.8665   -0.9309    1.0000
    0.6361   -0.7123    0.7976   -0.8931    1.0000

>> inv(V)
ans =
    8.9238   -6.5334    0.7240   24.5579  -27.6723
   10.0230   -9.1141    1.4612   10.4447  -12.8147
   -3.7580    0.6876    0.8518  -13.6375   15.8561
   -4.7803    4.1676    0.1049   -2.8701    3.3779
    0.1907    0.8377   -0.0054    0.1314   -0.1543

```

This may be repeated several times. As long as the points in x are distinct, the Vandermonde matrix V will be invertible.

6. (a) Enter $A1$, $A2$, ... $A5$. Then

```

>> rref(A1)
ans =
    1     0     0     0     0
    0     1     0     0     0
    0     0     1     0     0
    0     0     0     1     0
    0     0     0     0     1

```

We see $A1$ is invertible. The same result will come from $\text{rref}(A3)$ and $\text{rref}(A4)$, so both $A3$ and $A4$ are invertible.

```

>> rref(A2)
ans =
    1     0     3     1     0
    0     1    -2     3     0
    0     0     0     0     1
    0     0     0     0     0
    0     0     0     0     0

```

```

>> rref(A5)
ans =
    1    -2     0     0     1
    0     0     1     0    -2
    0     0     0     1     1
    0     0     0     0     0
    0     0     0     0     0

```

Both $A2$ and $A5$ are not invertible.

```

>> rref(A1*A2)
ans =
    1     0     3     1     0
    0     1    -2     3     0
    0     0     0     0     1
    0     0     0     0     0
    0     0     0     0     0

```

```
>> rref(A1*A3)
ans =
    1     0     0     0     0
    0     1     0     0     0
    0     0     1     0     0
    0     0     0     1     0
    0     0     0     0     1
```

$A1 \cdot A2$ is not invertible, and $A1 \cdot A3$ is invertible. From the list given $A1 \cdot A3$, $A1 \cdot A4$, and $A3 \cdot A4$ are invertible, while the others are not:

```
>> rref(A1*A5)
ans =
    1    -2     0     0     1
    0     0     1     0    -2
    0     0     0     1     1
    0     0     0     0     0
    0     0     0     0     0
```

```
>> rref(A2*A3)
ans =
    1    -2     0     0     1
    0     0     1     0    -2
    0     0     0     1     1
    0     0     0     0     0
    0     0     0     0     0
```

```
>> rref(A2*A4)
ans =
    1.0000     0    1.2857   -0.0621     0
           0    1.0000    0.2857    0.8509     0
           0     0         0         0    1.0000
           0     0         0         0         0
           0     0         0         0         0
```

```
>> rref(A2*A5)
ans =
    1    -2     0     0     1
    0     0     1     0    -2
    0     0     0     1     1
    0     0     0     0     0
    0     0     0     0     0
```

```
>> rref(A3*A5)
ans =
    1    -2     0     0     1
    0     0     1     0    -2
    0     0     0     1     1
    0     0     0     0     0
    0     0     0     0     0
```

```
>> rref(A4*A5)
ans =
    1    -2     0     0     1
    0     0     1     0    -2
    0     0     0     1     1
    0     0     0     0     0
    0     0     0     0     0
```

A product of two matrices will be invertible only if both of the original two matrices are invertible. In the above, since A_2 and A_5 were not invertible, any product involving either of these is not invertible.

(b) For $A_1 \cdot A_3$:

```
>> inv(A1*A3) - inv(A1)*inv(A3)
ans =
    4.8095  -20.8571  -3.3810  -15.8571    8.0857
   16.5833  -7.8690  16.5238  -4.7976    0.7357
    1.0238  13.0238    7.0476  10.0238   -5.7357
   -5.8452  -4.7024  -9.1190  -3.9881    2.9500
         0         0         0         0         0

>> inv(A1*A3) - inv(A3)*inv(A1)
ans =
  1.0e-14 *
   -0.0444         0    0.2665         0    0.0888
         0    0.1776   -0.0333    0.0888   -0.1332
    0.1332   -0.1776   -0.2665   -0.3553   -0.2665
   -0.1554    0.1776    0.1332    0.1776    0.0888
         0         0         0         0         0
```

The second result is 0 to within round off error. Similarly:

```
>> inv(A1*A4) - inv(A1)*inv(A4)
ans =
  -16.3571  13.5714    3.8571  10.4286    6.4286
    3.0000    9.5714    9.5000  18.3571  -14.1786
   -9.7143    9.2857    6.7143    8.5714    0.7500
    1.5000   -1.6429   -1.5000   -0.7143   -1.3929
    0.7857   -1.4286   -0.2857   -2.0000    0.7857

>> inv(A1*A4) - inv(A4)*inv(A1)
ans =
  1.0e-13 *
    0.0089   -0.3730    0.2087   -0.6040    0.3730
   -0.1066   -0.0355    0.3908   -0.1243    0.1599
   -0.0488   -0.0355    0.2309   -0.1599    0.1332
    0.0155   -0.0644   -0.0266   -0.0822    0.0389
    0.0006    0.0600   -0.0377    0.0977   -0.0622

>> inv(A3*A4) - inv(A3)*inv(A4)
ans =
  -74.6667  223.3333 -265.0000  117.6667  -63.7333
 -531.2333  320.8333 -435.5000  214.5000  -48.5667
 -435.0667  153.6667 -228.0000  119.0000   -1.9333
  158.9667  -20.3333  38.0000  -22.1667  -16.2667
   33.6000  -22.6667  30.0000  -14.6667    4.0000

>> inv(A3*A4) - inv(A4)*inv(A3)
ans =
  1.0e-11 *
   -0.1478    0.0284   -0.2160    0.1180   -0.0142
    0.0284   -0.1364   -0.1307    0.0796    0.0092
   -0.0114   -0.0625   -0.0966    0.0554    0.0014
    0.0014    0.0135    0.0199   -0.0117   -0.0001
    0.0092    0.0025    0.0181   -0.0107    0.0006
```

From these, we may conjecture that

$$(AB)^{-1} - B^{-1}A^{-1} = 0 \quad \text{or} \quad (AB)^{-1} = B^{-1}A^{-1}.$$

In fact, this will be true: see theorem 3 in this section.

7.

```
>> A = [ 1 2 3; 4 5 6; 7 8 9];
>> rref(A)
ans =
     1     0    -1
     0     1     2
     0     0     0
```

Since the bottom row is all zeros, A isn't invertible.

(a)

```
>> format short e % Use scientific notation.
>> f = 1.e-5; C = A; C(3,3) = A(3,3) + f;
>> inv(C)
ans =
 9.9998e+04 -2.0000e+05 1.0000e+05
-2.0000e+05 4.0000e+05 -2.0000e+05
 1.0000e+05 -2.0000e+05 1.0000e+05
```

(b)

```
>> f = 1.e-7; C = A; C(3,3) = A(3,3) + f;
>> inv(C)
ans =
 1.0000e+07 -2.0000e+07 1.0000e+07
-2.0000e+07 4.0000e+07 -2.0000e+07
 1.0000e+07 -2.0000e+07 1.0000e+07

>> f = 1.e-10; C = A; C(3,3) = A(3,3) + f;
>> inv(C)
ans =
 1.0000e+10 -2.0000e+10 1.0000e+10
-2.0000e+10 4.0000e+10 -2.0000e+10
 1.0000e+10 -2.0000e+10 1.0000e+10
```

(c) The entries in C^{-1} are roughly the same size as $1/f$.

(d)

```
>> x = [1;1;1];
>> f = 1.e-5; C = A; C(3,3) = A(3,3) + f; b = [6; 15; 24+f];
>> y = inv(C) * b
y =
 1.0000e+00
 1.0000e+00
 1.0000e+00

>> z = x-y
z =
     0
     0
 4.6566e-10
```

```

>> f = 1.e-7; C = A; C(3,3) = A(3,3) + f; b = [6; 15; 24+f];
>> y = inv(C) * b
y =
    1.0000e+00
    1.0000e+00
    1.0000e+00
>> z = x-y
z =
         0
   -5.9605e-08
   -5.9605e-08
>> f = 1.e-10; C = A; C(3,3) = A(3,3) + f; b = [6; 15; 24+f];
>> y = inv(C) * b
y =
    9.9997e-01
    1.0001e+00
    9.9997e-01
>> z = x-y
z =
    3.0518e-05
   -6.1035e-05
    3.0518e-05
>> format % Return to standard format for the next problem.

```

As f gets smaller, the error term z becomes larger. This means that the closer C is to a noninvertible matrix, the more error there is in the computation of C^{-1} . In fact the sum of the exponents in f and z is always -15 . This is related to the fact that there are about 15 significant digits in MATLAB's internal computations.

8. (a) Problem 37:

```

>> A = [ 0.293 0.014 0.044; 0 0.207 0.010; 0 0.017 0.216];
>> L = eye(3) -A % This is the Leontief matrix.
L =
    7.0700e-01  -1.4000e-02  -4.4000e-02
         0      7.9300e-01  -1.0000e-02
         0     -1.7000e-02   7.8400e-01
>> x = inv(L) * [ 13216; 17597; 1786]
x =
    1.0e+04 *
    1.9305
    2.2225
    0.2760

```

Israel needs 19,305 pounds for Agriculture, 22,225 for Manufacturing, and 2,760 for Energy to export the given amounts.

(b)

```

>> A = [ .2 .1 .3; .15 .25 .25; .1 .05 0];
>> L = eye(3) - A
>> format long
>> x = inv(L) * [300000; 200000; 200000]
x =
  1.0e+05 *
    5.37197626654496
    4.66453674121406
    2.77042446371520
>> format

```

This is the same answer as the one to 9(b) in Section 1.3.

9. If we arrange the message as a sequence of rows, then we need to multiply each row by the encoding matrix. Since these are rows, and not columns, the encoding matrix must be on the right. Write M for the message and C for the coded message. If encoding the message is done by multiplying by A then $C = M \cdot A$. Multiplying C by A^{-1} will decode the message because

$$C \cdot A^{-1} = (M \cdot A) \cdot A^{-1} = M \cdot (A \cdot A^{-1}) = M \cdot I = M.$$

```

>> A = [1 2 -3 4 5; -2 -5 8 -8 -9; 1 2 -2 7 9; 1 1 0 6 12; 2 4 -6 8 11]
>> C = [47 49 -19 257 487
        10 -9 63 137 236
        79 142 -184 372 536
        59 70 -40 332 588];
>> M = round(C * inv(A)) % use round to get rid of any small error term.
M =
     1     18     5     27     25
    15     21     27     8     1
    22     9     14     7     27
     6     21     14     27     27

>>setstr(M + 'A' - 1) % setstr(1:27 + 'A' - 1) is 'ABC...XYZ['
ans = % So given command prints the message
ARE[Y % but with '[' instead of ' '.
OU[HA
VING[
FUN[[

```

The message decodes to "ARE YOU HAVING FUN".

Section 1.9

$$1. \begin{pmatrix} -1 & 6 \\ 4 & 5 \end{pmatrix} \quad 2. \begin{pmatrix} 3 & 1 \\ 0 & 2 \end{pmatrix} \quad 3. \begin{pmatrix} 2 & -1 & 1 \\ 3 & 2 & 4 \end{pmatrix} \quad 4. \begin{pmatrix} 2 & 1 \\ -1 & 5 \\ 0 & 6 \end{pmatrix}$$

$$5. \begin{pmatrix} 1 & -1 & 1 \\ 2 & 0 & 5 \\ 3 & 4 & 5 \end{pmatrix} \quad 6. \begin{pmatrix} 1 & 2 & 3 \\ 2 & 4 & -5 \\ 3 & -5 & 7 \end{pmatrix} \quad 7. \begin{pmatrix} 1 & 0 \\ 0 & 1 \\ 1 & 0 \\ 0 & 1 \end{pmatrix}$$

$$8. \begin{pmatrix} 2 & 2 & 1 & 1 \\ -1 & 4 & 6 & 5 \end{pmatrix} \quad 9. \begin{pmatrix} a & d & g \\ b & e & h \\ c & f & j \end{pmatrix} \quad 10. \begin{pmatrix} 0 & 0 \\ 0 & 0 \\ 0 & 0 \end{pmatrix}$$

$$11. \text{ Let } A = \begin{pmatrix} a_{11} & a_{12} & \cdots & a_{1m} \\ a_{21} & a_{22} & \cdots & a_{2m} \\ \vdots & \vdots & & \vdots \\ a_{n1} & a_{n2} & \cdots & a_{nm} \end{pmatrix} \text{ and } B = \begin{pmatrix} b_{11} & b_{12} & \cdots & b_{1m} \\ b_{21} & b_{22} & \cdots & b_{2m} \\ \vdots & \vdots & & \vdots \\ b_{n1} & b_{n2} & \cdots & b_{nm} \end{pmatrix}$$

$$\text{Then } (A+B)^t = \begin{pmatrix} a_{11} + b_{11} & a_{21} + b_{21} & \cdots & a_{n1} + b_{n1} \\ a_{12} + b_{12} & a_{22} + b_{22} & \cdots & a_{n2} + b_{n2} \\ \vdots & \vdots & & \vdots \\ a_{1m} + b_{1m} & a_{2m} + b_{2m} & \cdots & a_{nm} + b_{nm} \end{pmatrix} = A^t + B^t$$

$$12. \alpha = 5; \beta = 3$$

13. $a_{ij} = a_{ji}$ and $b_{ij} = b_{ji}$ for $1 \leq i \leq n$ and $1 \leq j \leq n$. Then, $a_{ij} + b_{ij} = a_{ji} + b_{ji}$. Thus, $A + B$ is symmetric.

14. Since A is symmetric, $a_{jk} = a_{kj}$ for $1 \leq j \leq n, 1 \leq k \leq n$. And since B is symmetric, $b_{ki} = b_{ik}$ for $1 \leq i \leq n, 1 \leq k \leq n$. Therefore, $\sum_{k=1}^n a_{jk} b_{ki} = \sum_{k=1}^n b_{ik} a_{kj}$. Thus, $(AB)^t = BA$.

15. Suppose A is $m \times n$. Then A^t is $n \times m$. Then AA^t is defined and is an $m \times m$ matrix. Note that

$$\sum_{k=1}^n a_{ik} a_{jk} = \sum_{k=1}^n a_{jk} a_{ik}. \text{ That is, the } ij^{\text{th}} \text{ component of } AA^t \text{ is equal to the } ji^{\text{th}} \text{ component of } AA^t.$$

Thus, AA^t is symmetric. Another proof is that $(AA^t)^t = (A^t)^t A^t = AA^t$, so AA^t is equal to its own transpose, hence is symmetric.

16. If $i = j$ then clearly $a_{ij} = a_{ji}$. If $i \neq j$ then $a_{ij} = 0$ and $a_{ji} = 0$. Thus, $a_{ij} = a_{ji}$. Thus, A is symmetric.

17. Let $U = \begin{pmatrix} u_{11} & u_{12} & \cdots & u_{1n} \\ 0 & u_{22} & \cdots & u_{2n} \\ \vdots & & & \vdots \\ 0 & 0 & \cdots & 0 & u_{nn} \end{pmatrix}$ be upper triangular.

Then $U^t = \begin{pmatrix} u_{11} & 0 & \cdots & 0 \\ u_{12} & u_{22} & 0 & \cdots & 0 \\ \vdots & & & & \vdots \\ u_{1n} & u_{2n} & \cdots & 0 \end{pmatrix}$ is lower triangular.

18. (a) No (b) Yes (c) No (d) Yes

19. $A^t = -A$ and $B^t = -B$. Then $(A + B)^t = A^t + B^t = -A - B = -(A + B)$. Thus, $A + B$ is skew-symmetric.

20. $A^t = -A$. $a_{ij} = -a_{ji}$. Elements on the main diagonal are of the form a_{ii} . $a_{ii} = -a_{ii}$. It follows that $a_{ii} = 0$.

21. $(AB)^t = B^t A^t = (-B)(-A) = BA$. AB is symmetric if and only if $(AB)^t = AB$. But $(AB)^t = BA$. Thus AB is symmetric if and only if A and B commute.

22. The ij^{th} component of $(A + A^t)/2 = (a_{ij} + a_{ji})/2$ and the ji^{th} component of $(A + A^t)/2 = (a_{ji} + a_{ij})/2$. Thus $(A + A^t)/2$ is symmetric.

23. The ij^{th} component of $(A - A^t)/2 = (a_{ij} - a_{ji})/2$ and the ji^{th} component is $(a_{ji} - a_{ij})/2 = -(a_{ij} - a_{ji})/2$. Thus $(A - A^t)/2$ is skew-symmetric.

24. Let A , B , and C be $n \times n$ matrices. Suppose $A = B + C$ where B is symmetric and C is skew-symmetric. Then $a_{ij} = b_{ij} + c_{ij}$ and $a_{ji} = b_{ji} + c_{ji}$. But $b_{ij} = b_{ji}$ and $c_{ji} = -c_{ij}$.

$$\text{Then } b_{ij} + c_{ij} = a_{ij}$$

$$b_{ij} - c_{ij} = a_{ji}$$

Then $b_{ij} = (a_{ij} + a_{ji})/2$ and $c_{ij} = (a_{ij} - a_{ji})/2$. Note that these solutions are unique. Thus, any square matrix can be written in a unique way as the sum of the symmetric matrix $(A + A^t)/2$ and the skew-symmetric matrix $(A - A^t)/2$. (This uses the results of Problems 22 and 23.)

25. $AA^t = \begin{pmatrix} a_{11} & a_{12} \\ a_{21} & a_{22} \end{pmatrix} \begin{pmatrix} a_{11} & a_{21} \\ a_{12} & a_{22} \end{pmatrix} = \begin{pmatrix} a_{11}^2 + a_{12}^2 & a_{11}a_{21} + a_{12}a_{22} \\ a_{11}a_{21} + a_{12}a_{22} & a_{21}^2 + a_{22}^2 \end{pmatrix} = \begin{pmatrix} 1 & 0 \\ 0 & 1 \end{pmatrix}$. Thus A is invertible and $A^{-1} = A^t$.

$$26. A^t = \begin{pmatrix} 1 & 3 \\ 2 & 4 \end{pmatrix} \quad A^{-1} = -\frac{1}{2} \begin{pmatrix} 4 & -2 \\ -3 & 1 \end{pmatrix} \quad (A^t)^{-1} = -\frac{1}{2} \begin{pmatrix} 4 & -3 \\ -2 & 1 \end{pmatrix} = \begin{pmatrix} -2 & 3/2 \\ 1 & -1/2 \end{pmatrix} = (A^{-1})^t$$

$$27. A^t = \begin{pmatrix} 2 & 3 \\ 1 & 2 \end{pmatrix} \quad A^{-1} = \begin{pmatrix} 2 & -1 \\ -3 & 2 \end{pmatrix} \quad (A^t)^{-1} = \begin{pmatrix} 2 & -3 \\ -1 & 2 \end{pmatrix} = (A^{-1})^t$$

$$28. A^t = \begin{pmatrix} 3 & 0 & 0 \\ 2 & 2 & 0 \\ 1 & 2 & -1 \end{pmatrix} \quad A^{-1} = \begin{pmatrix} 1/3 & -1/3 & -1/3 \\ 0 & 1/2 & 1 \\ 0 & 0 & -1 \end{pmatrix} \quad (A^{-1})^t = \begin{pmatrix} 1/3 & 0 & 0 \\ -1/3 & 1/2 & 0 \\ -1/3 & 1 & -1 \end{pmatrix} = (A^t)^{-1}$$

$$29. A^t = \begin{pmatrix} 1 & 0 & 5 \\ 1 & 2 & 5 \\ 1 & 3 & 1 \end{pmatrix} \quad (A^{-1})^t = \begin{pmatrix} 13/8 & -15/8 & 5/4 \\ -1/2 & 1/2 & 0 \\ -1/8 & 3/8 & -1/4 \end{pmatrix} = (A^t)^{-1}$$

MATLAB 1.9

1.

```

>> A = round( 5*(2*rand(4,3)-1))
A =
   -3     4    -5
   -5    -1    -4
    2     0     0
    2     3     2

>> B = round( 5*(2*rand(3,2)-1))
B =
   -5    -1
   -1     2
   -4     1

>> (A*B)' - A' * B'
??? Error using ==> *
Inner matrix dimensions must agree.

>> (A*B)' - B' * A'
ans =
    0     0     0     0
    0     0     0     0

```

It is possible that $A^t B^t$ is not always defined. However $(AB)^t$ is always the same as $B^t A^t$.

2.

```

>> A = [1 2 3; 2 5 4; 1 -1 10]; % This was invertible.
>> inv(A')
ans =
   54.0000  -16.0000  -7.0000
  -23.0000   7.0000   3.0000
   -7.0000   2.0000   1.0000

>> inv(A)'
ans =
   54.0000  -16.0000  -7.0000
  -23.0000   7.0000   3.0000
   -7.0000   2.0000   1.0000

```

This should be repeated for each of the other matrices. In each case A^t is invertible if and only if A is invertible. Also, $(A^t)^{-1} = (A^{-1})^t$.

3. (a)

```

>> A = round( 10*(2*rand(4) -1) )
A =
    9     3     5    -3
    7    -2    -5     3
    1     4    -9     5
   -8     8     5    10

```

```
>> B = A' + A
B =
    18    10     6   -11
    10    -4    -1    11
     6    -1   -18    10
   -11    11    10    20
```

For any matrix A , B will be symmetric.

(b)

```
>> C = A' - A
C =
     0     4    -4    -5
    -4     0     9     5
     4    -9     0     0
     5    -5     0     0
```

For any A , C will be antisymmetric: $C^t = -C$.

(c)

```
>> G = A*A'    % For the matrix above.
G =
   124    23   -39   -53
    23    87    59   -67
   -39    59   123    29
   -53   -67    29   253

>> A = round( 10*(2*rand(3,4) - 1) )    % A non-square matrix.
A =
    -3     4    -9    -5
    -5     5     3    -1
    10     3     8     5

>> G = A*A'
G =
   131    13  -115
    13    60  -16
  -115   -16   198
```

For any matrix A , G will be symmetric.

- (d) If the ij entry of A is a_{ij} then the ij entry of A^t is a_{ji} . The ij entry of B is $b_{ij} = a_{ij} + a_{ji}$ which is the same as $b_{ji} = a_{ji} + a_{ij}$, so B is symmetric.
 The ij entry of C is $a_{ij} - a_{ji}$, while the ij entry of C^t is $a_{ji} - a_{ij} = -c_{ij}$, so $C^t = -C$.
 The ij entry of G will be $g_{ij} = \sum_k a_{ik}a_{jk}$. The ji entry of G will be $\sum_k a_{jk}a_{ik}$ which is the same as g_{ij} . Hence G is symmetric.

4. (a) In problem 2 from section 1.7, it was shown that the solution of $Ax = 0$ produces all vectors x that are perpendicular to the rows of A . Since the columns of A are the same as the rows of A^t , the solution of $A^t x = 0$ will produce all vectors x that are perpendicular to the columns of A .

(b) (i)

```
>> A = [2 0 1; 0 2 1; 1 1 1; -1 1 1; 1 1 1];
>> rref(A')
ans =
    1.0000     0    0.5000     0    0.5000
         0    1.0000    0.5000     0    0.5000
         0     0         0    1.0000     0
```

(ii) The solutions have x_3 and x_5 arbitrary, and $x_1 = -.5x_3 - .5x_5$, $x_2 = -.5x_3 - .5x_5$, and $x_4 = 0$.

```
>> A = [2 4 5; 0 5 7; 7 8 0; 7 0 4; 9 1 1];
>> rref(A')
ans =
    1.0000         0         0    5.8462    5.3846
         0    1.0000         0   -3.6044   -3.7033
         0         0    1.0000   -0.6703   -0.2527
```

(iii) The solutions have x_4 and x_5 arbitrary, and $x_1 = -5.8462x_4 - 5.3846x_5$, $x_2 = 3.6044x_4 + 3.7033x_5$, and $x_3 = .6703x_4 + .2527x_5$.

```
>> A = rand(5,3)
A =
    0.2661    0.3841    0.9410
    0.0907    0.2771    0.0501
    0.9478    0.9138    0.7615
    0.0737    0.5297    0.7702
    0.5007    0.4644    0.8278

>> rref(A')
ans =
    1.0000         0         0    1.0319    0.5701
         0    1.0000         0    1.7249   -0.4801
         0         0    1.0000   -0.3771    0.4142
```

The solutions have x_4 and x_5 arbitrary, and $x_1 = -1.0319x_4 - 0.5701x_5$, $x_2 = -1.7249x_4 + 0.4801x_5$, and $x_3 = 0.3771x_4 - 0.4142x_5$.

5.

```
>> A = 2*rand(4)-1
A =
   -0.7493    0.2591    0.7771    0.0265
   -0.9683    0.4724   -0.5336    0.1822
    0.3769    0.4508   -0.3874    0.6920
    0.7365    0.9989   -0.2980   -0.1758

>> Q = orth(A)
Q =
    0.5071    0.2864    0.7859   -0.2077
    0.6553    0.4839   -0.5678    0.1184
   -0.2551    0.3366   -0.1922   -0.8858
   -0.4984    0.7553    0.1515    0.3977
```

(a)

```
>> x = 2*rand(4,1)-1
x =
    0.6830
   -0.4614
   -0.1692
    0.0746
```

```

>> y = 2*rand(4,1)-1
y =
   -0.0642
   -0.4256
   -0.6433
   -0.6926

>> s = x' * y % The scalar product of x and y.
s =
    0.2097

>> r = ( Q*x )' * (Q*y) % The scalar product of Qx and Qy.
s =
    0.2097

>> format short e
>> s-r
ans =
   5.5511e-17

```

Since Q is orthogonal, $\mathbf{x} \cdot \mathbf{y}$ is the same as $(Q\mathbf{x}) \cdot (Q\mathbf{y})$.

- (b) If the above steps are repeated, even if A is complex, the inner product of \mathbf{x} and \mathbf{y} will always be the same as that of $Q\mathbf{x}$ and $Q\mathbf{y}$. (For complex A this depends on the fact that $A' = (\bar{A})^t$. Also you should reverse the \mathbf{x}, \mathbf{y} variables as $\mathbf{x} \cdot \mathbf{y} = \mathbf{y}' \cdot \mathbf{x}$ for complex vectors.)
- (c)

```

>> x = Q(:,1); y = Q(:,2); % Let x be the 1st column, and y the 2nd.
>> sqrt(x' * x) % the length of the 1st column.
ans =
    1.0000

>> x' * y % The inner product of the 1st and 2nd column.
ans =
   5.5511e-17

```

This is zero up to round off and the same results follow for all the other columns.

- (d)

```

>> inv(Q)
ans =
    0.5071    0.6553   -0.2551   -0.4984
    0.2864    0.4839    0.3366    0.7553
    0.7859   -0.5678   -0.1923    0.1515
   -0.2078    0.1184   -0.8858    0.3976

```

Q^{-1} and Q' are the same for any orthogonal matrix.

- (e) To show that $\mathbf{x} \cdot \mathbf{y} = Q\mathbf{x} \cdot Q\mathbf{y}$, we will use $Q^{-1} = Q^t$. (If Q is complex replace t with $'$.)

$$Q\mathbf{x} \cdot Q\mathbf{y} = (Q\mathbf{x})^t Q\mathbf{y} = \mathbf{x}^t Q^t Q\mathbf{y} = \mathbf{x}^t Q^{-1} Q\mathbf{y} = \mathbf{x}^t I\mathbf{y} = \mathbf{x}^t \mathbf{y} = \mathbf{x} \cdot \mathbf{y}.$$

The i th column of Q is $Q\mathbf{e}_i$ where \mathbf{e}_i is a vector with a 1 in the i th position and zeros elsewhere. This means that the inner product of the i th column of Q with the j th column can be written as $Q\mathbf{e}_i \cdot Q\mathbf{e}_j$. Using (b) we have that $Q\mathbf{e}_i \cdot Q\mathbf{e}_j = \mathbf{e}_i \cdot \mathbf{e}_j$, which is 1 if $i = j$ and is 0 if $i \neq j$. The statement in (c) follows immediately.

Section 1.10

1. $R_1 \rightleftharpoons R_2$ is an elementary matrix
2. $R_2 + R_1$ is an elementary matrix
3. Since two operations $R_1 \rightleftharpoons R_2$, $R_2 \rightarrow R_2 + R_1$ are needed, this is not an elementary matrix
4. $2R_2$ is an elementary matrix
5. Two operations needed: $R_1 \rightarrow 3R_1$, $R_2 \rightarrow 3R_2$, so not an elementary matrix
6. $R_1 \rightleftharpoons R_2$ is an elementary matrix
7. Two operations, $R_1 \rightleftharpoons R_2$, $R_2 \rightleftharpoons R_3$, so not an elementary matrix
8. Two operations needed, $R_2 \rightarrow R_2 + 2R_1$, $R_3 \rightarrow R_3 + 3R_1$, so not an elementary matrix
9. $R_2 + 2R_1$ is an elementary matrix
10. $R_4 + R_2$ is an elementary matrix
11. Two operations needed. $R_2 \rightarrow R_2 + R_1$, $R_4 \rightarrow R_4 + R_3$, so not an elementary matrix
12. $R_1 - R_2$ is an elementary matrix

13.
$$\begin{pmatrix} 1 & 0 & 0 \\ 0 & 4 & 0 \\ 0 & 0 & 1 \end{pmatrix}$$

14.
$$\begin{pmatrix} 1 & 0 & 0 \\ 2 & 1 & 0 \\ 0 & 0 & 1 \end{pmatrix}$$

15.
$$\begin{pmatrix} 1 & -3 & 0 \\ 0 & 1 & 0 \\ 0 & 0 & 1 \end{pmatrix}$$

16.
$$\begin{pmatrix} 1 & 0 & 4 \\ 0 & 1 & 0 \\ 0 & 0 & 1 \end{pmatrix}$$

17.
$$\begin{pmatrix} 0 & 0 & 1 \\ 0 & 1 & 0 \\ 1 & 0 & 0 \end{pmatrix}$$

18.
$$\begin{pmatrix} 1 & 0 & 0 \\ 0 & 0 & 1 \\ 0 & 1 & 0 \end{pmatrix}$$

19.
$$\begin{pmatrix} 1 & 0 & 0 \\ 0 & 1 & 1 \\ 0 & 0 & 1 \end{pmatrix}$$

20.
$$\begin{pmatrix} 1 & 0 & 0 \\ 0 & 1 & 0 \\ 0 & 0 & -1 \end{pmatrix}$$

21.
$$\begin{pmatrix} 1 & 0 \\ 0 & -2 \end{pmatrix}$$

22.
$$\begin{pmatrix} 1 & 0 \\ -2 & 1 \end{pmatrix}$$

23.
$$\begin{pmatrix} 1 & 2 \\ 0 & 1 \end{pmatrix}$$

24.
$$\begin{pmatrix} 0 & 1 \\ 1 & 0 \end{pmatrix}$$

25.
$$\begin{pmatrix} 0 & 0 & 1 \\ 0 & 1 & 0 \\ 1 & 0 & 0 \end{pmatrix}$$

26.
$$\begin{pmatrix} 1 & 0 & 0 \\ -3 & 1 & 0 \\ 0 & 0 & 1 \end{pmatrix}$$

27.
$$\begin{pmatrix} -1 & 0 & 0 \\ 0 & 1 & 0 \\ 0 & 0 & 1 \end{pmatrix}$$

28.
$$\begin{pmatrix} 1 & -2 & 0 \\ 0 & 1 & 0 \\ 0 & 0 & 1 \end{pmatrix}$$

29.
$$\begin{pmatrix} 1 & 0 & 0 \\ 0 & 1 & 0 \\ -5 & 0 & 1 \end{pmatrix}$$

30.
$$\begin{pmatrix} 1 & 2 & 0 \\ 0 & 1 & 0 \\ 0 & 0 & 1 \end{pmatrix}$$

31.
$$\begin{pmatrix} 0 & 1 \\ 1 & 0 \end{pmatrix}$$

32.
$$\begin{pmatrix} 1 & -3 \\ 0 & 1 \end{pmatrix}$$

33.
$$\begin{pmatrix} 1 & 0 \\ 0 & 1/4 \end{pmatrix}$$

34.
$$\begin{pmatrix} 0 & 1 & 0 \\ 1 & 0 & 0 \\ 0 & 0 & 1 \end{pmatrix}$$

35.
$$\begin{pmatrix} 1 & 2 & 0 \\ 0 & 1 & 0 \\ 0 & 0 & 1 \end{pmatrix}$$

36.
$$\begin{pmatrix} 1 & 0 & 0 \\ 0 & 1 & 0 \\ 2 & 0 & 1 \end{pmatrix}$$

37.
$$\begin{pmatrix} 1 & 0 & 0 \\ 0 & -2 & 0 \\ 0 & 0 & 1 \end{pmatrix}$$

38.
$$\begin{pmatrix} 1 & 0 & -1 & 0 \\ 0 & 1 & 0 & 0 \\ 0 & 0 & 1 & 0 \\ 0 & 0 & 0 & 1 \end{pmatrix}$$

39.
$$\begin{pmatrix} 1 & 0 & 0 & -5 \\ 0 & 1 & 0 & 0 \\ 0 & 0 & 1 & 0 \\ 0 & 0 & 0 & 1 \end{pmatrix}$$

40.
$$\begin{pmatrix} 1 & 0 & 0 & 0 \\ 0 & 1 & 0 & 0 \\ 0 & 3 & 1 & 0 \\ 0 & 0 & 0 & 1 \end{pmatrix}$$

$$41. \begin{pmatrix} 2 & 1 \\ 3 & 2 \end{pmatrix} \xrightarrow{\substack{R_1 \rightarrow \frac{1}{2}R_1 \\ R_2 \rightarrow R_2 - 3R_1}} \begin{pmatrix} 1 & 1/2 \\ 0 & 1/2 \end{pmatrix} \xrightarrow{\substack{R_2 \rightarrow 2R_2 \\ R_1 \rightarrow R_1 - \frac{1}{2}R_2}} \begin{pmatrix} 1 & 0 \\ 0 & 1 \end{pmatrix}$$

$$A = \begin{pmatrix} 2 & 0 \\ 0 & 1 \end{pmatrix} \begin{pmatrix} 1 & 0 \\ 3 & 1 \end{pmatrix} \begin{pmatrix} 1 & 0 \\ 0 & 1/2 \end{pmatrix} \begin{pmatrix} 1 & 1/2 \\ 0 & 1 \end{pmatrix}$$

$$42. \begin{pmatrix} 1 & 2 \\ 3 & 4 \end{pmatrix} \xrightarrow{R_2 \rightarrow R_2 - 3R_1} \begin{pmatrix} 1 & 2 \\ 0 & -2 \end{pmatrix} \xrightarrow{\substack{R_2 \rightarrow -\frac{1}{2}R_2 \\ R_1 \rightarrow R_1 - 2R_2}} \begin{pmatrix} 1 & 0 \\ 0 & 1 \end{pmatrix}$$

$$A = \begin{pmatrix} 1 & 0 \\ 3 & 1 \end{pmatrix} \begin{pmatrix} 1 & 0 \\ 0 & -2 \end{pmatrix} \begin{pmatrix} 1 & 2 \\ 0 & 1 \end{pmatrix}$$

$$43. \begin{pmatrix} 1 & 1 & 1 \\ 0 & 2 & 3 \\ 5 & 5 & 1 \end{pmatrix} \xrightarrow{\substack{R_3 \rightarrow R_3 - 5R_1 \\ R_2 \rightarrow \frac{1}{2}R_2 \\ R_1 \rightarrow R_1 - R_2}} \begin{pmatrix} 1 & 0 & -1/2 \\ 0 & 1 & 3/2 \\ 0 & 0 & -4 \end{pmatrix} \xrightarrow{\substack{R_3 \rightarrow -\frac{1}{4}R_3 \\ R_2 \rightarrow R_2 - 1.5R_3 \\ R_1 \rightarrow R_1 + 0.5R_3}} \begin{pmatrix} 1 & 0 & 0 \\ 0 & 1 & 0 \\ 0 & 0 & 1 \end{pmatrix}$$

$$A = \begin{pmatrix} 1 & 0 & 0 \\ 0 & 1 & 0 \\ 5 & 0 & 1 \end{pmatrix} \begin{pmatrix} 1 & 0 & 0 \\ 0 & 2 & 0 \\ 0 & 0 & 1 \end{pmatrix} \begin{pmatrix} 1 & 1 & 0 \\ 0 & 1 & 0 \\ 0 & 0 & 1 \end{pmatrix} \begin{pmatrix} 1 & 0 & 0 \\ 0 & 1 & 0 \\ 0 & 0 & -4 \end{pmatrix} \begin{pmatrix} 1 & 0 & -1/2 \\ 0 & 1 & 0 \\ 0 & 0 & 1 \end{pmatrix} \begin{pmatrix} 1 & 0 & 0 \\ 0 & 1 & 3/2 \\ 0 & 0 & 1 \end{pmatrix}$$

$$44. \begin{pmatrix} 3 & 2 & 1 \\ 0 & 2 & 2 \\ 0 & 0 & -1 \end{pmatrix} \xrightarrow{\substack{R_1 \rightarrow \frac{1}{3}R_1 \\ R_2 \rightarrow 0.5R_2 \\ R_1 \rightarrow R_1 - \frac{2}{3}R_2}} \begin{pmatrix} 1 & 0 & -1/3 \\ 0 & 1 & 1 \\ 0 & 0 & -1 \end{pmatrix} \xrightarrow{\substack{R_3 \rightarrow -R_3 \\ R_2 \rightarrow R_2 - R_3 \\ R_1 \rightarrow R_1 + \frac{1}{3}R_3}} \begin{pmatrix} 1 & 0 & 0 \\ 0 & 1 & 0 \\ 0 & 0 & 1 \end{pmatrix}$$

$$A = \begin{pmatrix} 3 & 0 & 0 \\ 0 & 1 & 0 \\ 0 & 0 & 1 \end{pmatrix} \begin{pmatrix} 1 & 0 & 0 \\ 0 & 2 & 0 \\ 0 & 0 & 1 \end{pmatrix} \begin{pmatrix} 1 & 2/3 & 0 \\ 0 & 1 & 0 \\ 0 & 0 & 1 \end{pmatrix} \begin{pmatrix} 1 & 0 & 0 \\ 0 & 1 & 0 \\ 0 & 0 & -1 \end{pmatrix} \begin{pmatrix} 1 & 0 & 0 \\ 0 & 1 & 1 \\ 0 & 0 & 1 \end{pmatrix} \begin{pmatrix} 1 & 0 & -1/3 \\ 0 & 1 & 0 \\ 0 & 0 & 1 \end{pmatrix}$$

$$45. \begin{pmatrix} 0 & -1 & 0 \\ 0 & 1 & -1 \\ 1 & 0 & 1 \end{pmatrix} \xrightarrow{\substack{R_1 \leftrightarrow R_3 \\ R_3 \rightarrow R_3 + R_2}} \begin{pmatrix} 1 & 0 & 1 \\ 0 & 1 & -1 \\ 0 & 0 & -1 \end{pmatrix} \xrightarrow{\substack{R_3 \rightarrow -R_3 \\ R_2 \rightarrow R_2 + R_3 \\ R_1 \rightarrow R_1 - R_3}} \begin{pmatrix} 1 & 0 & 0 \\ 0 & 1 & 0 \\ 0 & 0 & 1 \end{pmatrix}$$

$$A = \begin{pmatrix} 0 & 0 & 1 \\ 0 & 1 & 0 \\ 1 & 0 & 0 \end{pmatrix} \begin{pmatrix} 1 & 0 & 0 \\ 0 & 1 & 0 \\ 0 & -1 & 1 \end{pmatrix} \begin{pmatrix} 1 & 0 & 0 \\ 0 & 1 & 0 \\ 0 & 0 & -1 \end{pmatrix} \begin{pmatrix} 1 & 0 & 1 \\ 0 & 1 & 0 \\ 0 & 0 & 1 \end{pmatrix} \begin{pmatrix} 1 & 0 & 0 \\ 0 & 1 & -1 \\ 0 & 0 & 1 \end{pmatrix}$$

$$46. \begin{pmatrix} 2 & 0 & 4 \\ 0 & 1 & 1 \\ 3 & -1 & 1 \end{pmatrix} \xrightarrow{\substack{R_1 \rightarrow \frac{1}{2}R_1 \\ R_3 \rightarrow R_3 - 3R_1 \\ R_3 \rightarrow R_3 + R_2}} \begin{pmatrix} 1 & 0 & 2 \\ 0 & 1 & 1 \\ 0 & 0 & -4 \end{pmatrix} \xrightarrow{\substack{R_3 \rightarrow -\frac{1}{4}R_3 \\ R_2 \rightarrow R_2 - R_3 \\ R_1 \rightarrow R_1 - 2R_3}} \begin{pmatrix} 1 & 0 & 0 \\ 0 & 1 & 0 \\ 0 & 0 & 1 \end{pmatrix}$$

$$A = \begin{pmatrix} 2 & 0 & 0 \\ 0 & 1 & 0 \\ 0 & 0 & 1 \end{pmatrix} \begin{pmatrix} 1 & 0 & 0 \\ 0 & 1 & 0 \\ 3 & 0 & 1 \end{pmatrix} \begin{pmatrix} 1 & 0 & 0 \\ 0 & 1 & 0 \\ 0 & -1 & 1 \end{pmatrix} \begin{pmatrix} 1 & 0 & 0 \\ 0 & 1 & 0 \\ 0 & 0 & -4 \end{pmatrix} \begin{pmatrix} 1 & 0 & 0 \\ 0 & 1 & 1 \\ 0 & 0 & 1 \end{pmatrix} \begin{pmatrix} 1 & 0 & 2 \\ 0 & 1 & 0 \\ 0 & 0 & 1 \end{pmatrix}$$

$$47. A = \begin{pmatrix} 2 & 0 & 0 & 0 \\ 0 & 1 & 0 & 0 \\ 0 & 0 & 1 & 0 \\ 0 & 0 & 0 & 1 \end{pmatrix} \begin{pmatrix} 1 & 0 & 0 & 0 \\ 0 & 3 & 0 & 0 \\ 0 & 0 & 1 & 0 \\ 0 & 0 & 0 & 1 \end{pmatrix} \begin{pmatrix} 1 & 0 & 0 & 0 \\ 0 & 1 & 0 & 0 \\ 0 & 0 & -4 & 0 \\ 0 & 0 & 0 & 1 \end{pmatrix} \begin{pmatrix} 1 & 0 & 0 & 0 \\ 0 & 1 & 0 & 0 \\ 0 & 0 & 1 & 0 \\ 0 & 0 & 0 & 5 \end{pmatrix}$$

$$48. \begin{pmatrix} 2 & 1 & 0 & 0 \\ 0 & 2 & 1 & 0 \\ 0 & 0 & 2 & 1 \\ 0 & 0 & 0 & 2 \end{pmatrix} \xrightarrow{\begin{matrix} R_1 \rightarrow 0.5R_1 \\ R_2 \rightarrow 0.5R_2 \\ R_1 \rightarrow R_1 - 0.5R_2 \end{matrix}} \begin{pmatrix} 1 & 0 & -1/4 & 0 \\ 0 & 1 & 1/2 & 0 \\ 0 & 0 & 2 & 1 \\ 0 & 0 & 0 & 2 \end{pmatrix} \xrightarrow{\begin{matrix} R_3 \rightarrow 0.5R_3 \\ R_2 \rightarrow R_2 - 0.5R_3 \\ R_1 \rightarrow R_1 + \frac{1}{4}R_3 \end{matrix}}$$

$$\begin{pmatrix} 1 & 0 & 1/8 & 0 \\ 0 & 1 & 0 & -1/4 \\ 0 & 0 & 1 & 1/2 \\ 0 & 0 & 0 & 2 \end{pmatrix} \xrightarrow{\begin{matrix} R_4 \rightarrow 0.5R_4 \\ R_3 \rightarrow R_3 - 0.5R_4 \\ R_2 \rightarrow R_2 + 0.25R_4 \\ R_1 \rightarrow R_1 - \frac{1}{8}R_4 \end{matrix}} \begin{pmatrix} 1 & 0 & 0 & 0 \\ 0 & 1 & 0 & 0 \\ 0 & 0 & 1 & 0 \\ 0 & 0 & 0 & 1 \end{pmatrix}$$

$$A = \begin{pmatrix} 2 & 0 & 0 & 0 \\ 0 & 1 & 0 & 0 \\ 0 & 0 & 1 & 0 \\ 0 & 0 & 0 & 1 \end{pmatrix} \begin{pmatrix} 1 & 0 & 0 & 0 \\ 0 & 2 & 0 & 0 \\ 0 & 0 & 1 & 0 \\ 0 & 0 & 0 & 1 \end{pmatrix} \begin{pmatrix} 1 & 1/2 & 0 & 0 \\ 0 & 1 & 0 & 0 \\ 0 & 0 & 1 & 0 \\ 0 & 0 & 0 & 1 \end{pmatrix} \begin{pmatrix} 1 & 0 & 0 & 0 \\ 0 & 1 & 0 & 0 \\ 0 & 0 & 2 & 0 \\ 0 & 0 & 0 & 1 \end{pmatrix} \begin{pmatrix} 1 & 0 & 0 & 0 \\ 0 & 1 & 1/2 & 0 \\ 0 & 0 & 1 & 0 \\ 0 & 0 & 0 & 1 \end{pmatrix}$$

$$\begin{pmatrix} 1 & 0 & -1/4 & 0 \\ 0 & 1 & 0 & 0 \\ 0 & 0 & 1 & 0 \\ 0 & 0 & 0 & 1 \end{pmatrix}$$

$$A = \begin{pmatrix} 1 & 0 & 0 & 0 \\ 0 & 1 & 0 & 0 \\ 0 & 0 & 1 & 0 \\ 0 & 0 & 0 & 2 \end{pmatrix} \begin{pmatrix} 1 & 0 & 0 & 0 \\ 0 & 1 & 0 & 0 \\ 0 & 0 & 1 & 1/2 \\ 0 & 0 & 0 & 1 \end{pmatrix} \begin{pmatrix} 1 & 0 & 0 & 0 \\ 0 & 1 & 0 & -1/4 \\ 0 & 0 & 1 & 0 \\ 0 & 0 & 0 & 1 \end{pmatrix} \begin{pmatrix} 1 & 0 & 0 & 1/8 \\ 0 & 1 & 0 & 0 \\ 0 & 0 & 1 & 0 \\ 0 & 0 & 0 & 1 \end{pmatrix}$$

49. $ac \neq 0$ implies $a \neq 0$ and $c \neq 0$. Row reducing A to I_2 by back elimination via

$$\begin{pmatrix} a & b \\ 0 & c \end{pmatrix} \xrightarrow{\begin{matrix} c^{-1}R_2 \\ R_1 \rightarrow R_1 - bR_2 \end{matrix}} \begin{pmatrix} a & 0 \\ 0 & 1 \end{pmatrix} \xrightarrow{a^{-1}R_1} \begin{pmatrix} 1 & 0 \\ 0 & 1 \end{pmatrix}$$

shows $I_2 = (a^{-1}R_1)(R_1 - bR_2)(c^{-1}R_2)A$. So solving for A gives $A = (cR_2)(R_1 + bR_2)(aR_1)$, or

$$A = \begin{pmatrix} a & b \\ 0 & c \end{pmatrix} = \begin{pmatrix} 1 & 0 \\ 0 & c \end{pmatrix} \begin{pmatrix} 1 & b \\ 0 & 1 \end{pmatrix} \begin{pmatrix} a & 0 \\ 0 & 1 \end{pmatrix} \\ = \begin{pmatrix} 1 & b \\ 0 & c \end{pmatrix} \begin{pmatrix} a & 0 \\ 0 & 1 \end{pmatrix}$$

50. $adf \neq 0$ implies a , d and f are nonzero. Row reducing A to I_3 by back elimination gives

$$\begin{pmatrix} a & b & c \\ 0 & d & e \\ 0 & 0 & f \end{pmatrix} \xrightarrow{\begin{matrix} f^{-1}R_1 \\ R_2 \rightarrow R_2 - eR_3 \\ R_1 \rightarrow R_1 - cR_3 \end{matrix}} \begin{pmatrix} a & b & 0 \\ 0 & d & 0 \\ 0 & 0 & 1 \end{pmatrix} \xrightarrow{\begin{matrix} d^{-1}R_2 \\ R_1 \rightarrow R_1 - bR_2 \end{matrix}} \begin{pmatrix} a & 0 & 0 \\ 0 & 1 & 0 \\ 0 & 0 & 1 \end{pmatrix} \xrightarrow{a^{-1}R_1} I_3$$

So taking all the inverse operations applied to I_3 (in the opposite order) shows

$$\begin{aligned} A &= \begin{pmatrix} 1 & 0 & 0 \\ 0 & 1 & 0 \\ 0 & 0 & f \end{pmatrix} \begin{pmatrix} 1 & 0 & 0 \\ 0 & 1 & e \\ 0 & 0 & 1 \end{pmatrix} \begin{pmatrix} 1 & 0 & c \\ 0 & 1 & 0 \\ 0 & 0 & 1 \end{pmatrix} \begin{pmatrix} 1 & 0 & 0 \\ 0 & d & 0 \\ 0 & 0 & 1 \end{pmatrix} \begin{pmatrix} 1 & b & 0 \\ 0 & 1 & 0 \\ 0 & 0 & 1 \end{pmatrix} \begin{pmatrix} a & 0 & 0 \\ 0 & 1 & 0 \\ 0 & 0 & 1 \end{pmatrix} \\ &= \begin{pmatrix} 1 & 0 & c \\ 0 & 1 & e \\ 0 & 0 & f \end{pmatrix} \begin{pmatrix} 1 & b & 0 \\ 0 & d & 0 \\ 0 & 0 & 1 \end{pmatrix} \begin{pmatrix} a & 0 & 0 \\ 0 & 1 & 0 \\ 0 & 0 & 1 \end{pmatrix} \end{aligned}$$

51. Let $U = (u_{11}^{-1}R_1)(u_{22}^{-1}R_2)\cdots(u_{nn}^{-1}R_n)A$. Then U is an $n \times n$ matrix with 1's down the diagonal and 0's below it. Note that U is row equivalent to I and hence, by theorem 4, can be written as a product of elementary matrices. If $U = E_1E_2\cdots E_k$, where each E_i is an elementary matrix, then $A = (u_{nn}R_n)\cdots(u_{22}R_2)(u_{11}R_1)E_1E_2\cdots E_k$. By theorem 4, A is invertible.
52. By problem 51, A is invertible. As in problem 51, let $U = (u_{11}^{-1}R_1)(u_{22}^{-1}R_2)\cdots(u_{nn}^{-1}R_n)A$. Since U has 1's down the diagonal and 0's below it, when row reducing U to I we need only add multiples of a row to those rows above it. Hence, we can write U as a product of upper triangular elementary matrices: $U = E_1E_2\cdots E_k$. Note that E_i^{-1} is upper triangular for each i . Show that the product of two upper triangular matrices is upper triangular. Then deduce $A^{-1} = E_k^{-1}\cdots E_2^{-1}E_1^{-1}(u_{11}^{-1}R_1)(u_{22}^{-1}R_2)\cdots(u_{nn}^{-1}R_n)$ is upper triangular.
53. A^t is upper triangular, so $(A^t)^{-1}$ is upper triangular by the result of problem 52. But $(A^t)^{-1} = (A^{-1})^t$, so $(A^{-1})^t$ is upper triangular, which means that $A^{-1} = [(A^{-1})^t]^t$ is lower triangular.
54. $P_{ij}A = C$ where $c_{rs} = \sum_{k=1}^n p_{rk}a_{ks}$. If $r = i$, then $c_{is} = \sum_{k=1}^n p_{ik}a_{ks} = a_{js}$ since p_{ik} is 1 if $k = j$ and 0 otherwise. If $r = j$, then $c_{js} = a_{is}$ since p_{jk} is 1 if $k = i$ and 0 otherwise. If $r \neq i$ and $r \neq j$, then $c_{rs} = a_{rs}$. Hence, $P_{ij}A$ is the matrix obtained by permuting the i^{th} and j^{th} rows.
55. $A_{ij}A = B$ where $b_{rs} = \sum_{k=1}^n a'_{rk}a_{ks}$. If $r \neq j$, then $b_{rs} = a_{rs}$ since a'_{rk} is 1 if $k = r$ and 0 otherwise. If $r = j$, then $b_{js} = \sum_{k=1}^n a'_{jk}a_{ks} = ca_{is} + a_{js}$ since a'_{jk} is c if $k = i$, 1 if $k = j$, and 0 otherwise. Hence, $A_{ij}A$ is the matrix obtained from A by multiplying the i^{th} row by c and adding it to the j^{th} row.
56. $M_iA = B$ where $b_{rs} = \sum_{k=1}^m m_{rk}a_{ks}$. If $r = i$, then $b_{is} = ca_{is}$ since m_{ik} is c if $k = i$ and 0 otherwise. If $r \neq i$, then $b_{rs} = a_{rs}$ since m_{rk} is 1 if $k = r$ and 0 otherwise. It follows that M_iA is the matrix obtained from A by multiplying the i^{th} row by c .
57. $\begin{pmatrix} 1 & 2 \\ 2 & 4 \end{pmatrix} \xrightarrow{R_2 \rightarrow R_2 - 2R_1} \begin{pmatrix} 1 & 2 \\ 0 & 0 \end{pmatrix}, \quad A = \begin{pmatrix} 1 & 0 \\ 2 & 1 \end{pmatrix} \begin{pmatrix} 1 & 2 \\ 0 & 0 \end{pmatrix}$

$$58. \begin{pmatrix} 2 & -3 \\ -4 & 6 \end{pmatrix} \rightarrow \begin{pmatrix} 2 & -3 \\ 0 & 0 \end{pmatrix} \quad A = \begin{pmatrix} 1 & 0 \\ -2 & 1 \end{pmatrix} \begin{pmatrix} 2 & -3 \\ 0 & 0 \end{pmatrix}$$

$$59. \begin{pmatrix} 0 & 0 \\ 1 & 0 \end{pmatrix} \rightarrow \begin{pmatrix} 1 & 0 \\ 0 & 0 \end{pmatrix} \quad A = \begin{pmatrix} 0 & 1 \\ 1 & 0 \end{pmatrix} \begin{pmatrix} 1 & 0 \\ 0 & 0 \end{pmatrix}$$

$$60. \begin{pmatrix} 1 & -1 & 2 \\ 2 & 1 & 4 \\ 4 & -1 & 8 \end{pmatrix} \rightarrow \begin{pmatrix} 1 & -1 & 2 \\ 0 & 3 & 0 \\ 0 & 0 & 0 \end{pmatrix}$$

$$A = \begin{pmatrix} 1 & 0 & 0 \\ 2 & 1 & 0 \\ 0 & 0 & 1 \end{pmatrix} \begin{pmatrix} 1 & 0 & 0 \\ 0 & 1 & 0 \\ 4 & 0 & 1 \end{pmatrix} \begin{pmatrix} 1 & 0 & 0 \\ 0 & 1 & 0 \\ 0 & 1 & 1 \end{pmatrix} \begin{pmatrix} 1 & -1 & 2 \\ 0 & 3 & 0 \\ 0 & 0 & 0 \end{pmatrix}$$

$$61. \begin{pmatrix} 1 & -3 & 3 \\ 0 & -3 & 1 \\ 1 & 0 & 2 \end{pmatrix} \rightarrow \begin{pmatrix} 1 & -3 & 3 \\ 0 & 1 & -1/3 \\ 0 & 0 & 0 \end{pmatrix}$$

$$A = \begin{pmatrix} 1 & 0 & 0 \\ 0 & 1 & 0 \\ 1 & 0 & 1 \end{pmatrix} \begin{pmatrix} 1 & 0 & 0 \\ 0 & -3 & 0 \\ 0 & 0 & 1 \end{pmatrix} \begin{pmatrix} 1 & 0 & 0 \\ 0 & 1 & 0 \\ 0 & 3 & 1 \end{pmatrix} \begin{pmatrix} 1 & -3 & 3 \\ 0 & 1 & -1/3 \\ 0 & 0 & 0 \end{pmatrix}$$

$$62. \begin{pmatrix} 1 & 0 & 0 \\ 2 & 3 & 0 \\ -1 & 4 & 0 \end{pmatrix} \rightarrow \begin{pmatrix} 1 & 0 & 0 \\ 0 & 1 & 0 \\ 0 & 0 & 0 \end{pmatrix}$$

$$A = \begin{pmatrix} 1 & 0 & 0 \\ 2 & 1 & 0 \\ 0 & 0 & 1 \end{pmatrix} \begin{pmatrix} 1 & 0 & 0 \\ 0 & 1 & 0 \\ -1 & 0 & 1 \end{pmatrix} \begin{pmatrix} 1 & 0 & 0 \\ 0 & 3 & 0 \\ 0 & 0 & 1 \end{pmatrix} \begin{pmatrix} 1 & 0 & 0 \\ 0 & 1 & 0 \\ 0 & 4 & 1 \end{pmatrix} \begin{pmatrix} 1 & 0 & 0 \\ 0 & 1 & 0 \\ 0 & 0 & 0 \end{pmatrix}$$

MATLAB 1.10

1. (a)

```
>> A = round(10 * (2*rand(4)-1))
A =
  -6     9    -9   -10
  -9    -2    -9    -2
   4     0     1    -9
   4     7     3    -2
```

(i)

```
>> F=eye(4); F(3,3) = 4;   % R3 --> 4 R3, i.e. multiply R3 by 4
>> F*A
ans =
  -6     9    -9   -10
  -9    -2    -9    -2
  16     0     4   -36
   4     7     3    -2
```

(ii)

```
>> F=eye(4); F(1,2) = -3;   % R1 --> R1 - 3 R2, i.e. subtract 3R2 from R1
>> F*A
ans =
  21    15    18    -4
  -9    -2    -9    -2
   4     0     1    -9
   4     7     3    -2
```

(iii)

```
>> F=eye(4); F([1 4],:) = F([4,1],:);   % interchange 1 and 4.
>> F*A
ans =
   4     7     3    -2
  -9    -2    -9    -2
   4     0     1    -9
  -6     9    -9   -10
```

(b)

```
>> F=eye(4); F(3,3) = 4;   % Part (i): R3 --> 4 R3
>> inv(F)                   % This is R3 --> 1/4 R3, i.e. divide R3 by 4.
ans =
  1.0000         0         0         0
         0  1.0000         0         0
         0         0  0.2500         0
         0         0         0  1.0000
```

(ii)

```
>> F=eye(4); F(1,2) = -3; % R1 --> R1 - 3 R2,
>> inv(F) % This is R1 --> R1 + 3 R2, i.e. add 3R2 to R1.
ans =
    1     3     0     0
    0     1     0     0
    0     0     1     0
    0     0     0     1
```

```
>> F=eye(4); F([1 4],:) = F([4,1],:); % Part (iii): interchange 1 and 4.
>> inv(F) % This also interchanges 1 and 4.
ans =
    0     0     0     1
    0     1     0     0
    0     0     1     0
    1     0     0     0
```

In each case, the inverse of F represents a row operation that is the reverse of the original operation.

2. (a)

```
>> A = [7 2 3; -1 0 4; 2 1 1]
A =
    7     2     3
   -1     0     4
    2     1     1
>> B = A; % Store this matrix in B.
>> c = -B(2,1)/B(1,1); % Compute the multiplier to eliminate B(2,1).
>> F1 = eye(3); F1(2,1) = c; % Generate the elementary matrix which
% subtracts c*row 1 from row 2.
>> B = F1*B; % Apply the matrix F1 to B.
>> F = F1; % F will be the product of the elementary matrices.

>> c = -B(3,1)/B(1,1); % Compute the multiplier to eliminate B(3,1).
>> F2 = eye(3); F2(3,1) = c; % Form elementary matrix for R3-cR1
>> B = F2*B; % Finish column 1 elimination
B =
    7.0000    2.0000    3.0000
     0    0.2857    4.4286
     0    0.4286    0.1429
>> F = F2*F; % F accumulates the product of Fi's.

>> c = -B(3,2)/B(2,2); % Next, eliminate B(3,2) in column 2.
>> F3 = eye(3); F3(3,2) = c; % This will finish forward elimination
>> B = F3*B; % Apply the matrix to B.
B =
    7.0000    2.0000    3.0000
     0    0.2857    4.4286
     0     0   -6.5000
>> F = F3*F; % Keep track of F.

>> c = 1/B(3,3); % Start backelimination, divide row 3 by B(3,3).
>> F4 = eye(3); F4(3,3) = c;
>> B = F4*B; % Normalize R3 to start with 1.
>> F = F4*F; % Keep track of F.
```

```

>> c = -B(2,3)/B(3,3);           % Now backeliminate B(2,3).
>> F5 = eye(3); F5(2,3) = c;
>> B = F5*B;                     % Apply the matrix to B.
>> F = F5*F;                     % Keep track of F.

>> c = -B(1,3)/B(3,3);           % Next, backeliminate B(1,3) to finish column 3.
>> F6 = eye(3); F6(1,3) = c;
>> B = F6*B                       % Apply the matrix to B.
B =
    7.0000    2.0000    0
         0    0.2857    0
         0         0    1.0000
>> F = F6*F;                     % Keep track of F.

>> c = 1/B(2,2);                 % Next, divide row 2 by B(2,2).
>> F7 = eye(3); F7(2,2) = c;
>> B = F7*B                       % Normalize row 2 to start with 1.
B =
     7     2     0
     0     1     0
     0     0     1
>> F = F7*F;                     % Keep track of F.

>> c = -B(1,2)/B(2,2);           % Next, backeliminate B(1,2).
>> F8 = eye(3); F8(1,2) = c;
>> B = F8*B                       % Apply the matrix to B, finish column 2.
B =
     7     0     0
     0     1     0
     0     0     1
>> F = F8*F;                     % Keep track of F.

>> c = 1/B(1,1);                 % Finish by dividing row 1 by B(1,1).
>> F9 = eye(3); F9(1,1) = c;
>> B = F9*B                       % Normalizing R1 gives rref(A)
B =
     1     0     0
     0     1     0
     0     0     1
>> F = F9*F                       % Form the final product of Fi's.
F =
    0.3077   -0.0769   -0.6154
   -0.6923   -0.0769    2.3846
    0.0769    0.2308   -0.1538

```

(b)

```

>> F*A
ans =
    1.0000    0.0000    0.0000
    0.0000    1.0000    0.0000
         0         0    1.0000
>> A*F
ans =
    1.0000         0    0.0000
         0    1.0000    0.0000
    0.0000    0.0000    1.0000

```



```

B =
    1.0000         0    2.5000
         0    2.0000    3.0000
         0    2.0000   -7.0000

>> F = F4*F;           % Keep track of F.
>> c = -B(3,2)/B(2,2); % Next, eliminate B(3,2).
>> F5 = eye(3); F5(3,2) = c;
>> B = F5*B           % Apply the matrix to B.

B =
    1.0000         0    2.5000
         0    2.0000    3.0000
         0         0  -10.0000

>> F = F5*F;           % Keep track of F.
>> c = 1/B(2,2);       % Next, divide row 2 by B(2,2).
>> F6 = eye(3); F6(2,2) = c;
>> B = F6*B           % Apply the matrix to B.

B =
    1.0000         0    2.5000
         0    1.0000    1.5000
         0         0  -10.0000

>> F = F6*F;           % Keep track of F.
>> c = -B(1,3)/B(3,3); % Next, eliminate B(1,3).
>> F7 = eye(3); F7(1,3) = c;
>> B = F7*B           % Apply the matrix to B.

B =
    1.0000         0         0
         0    1.0000    1.5000
         0         0  -10.0000

>> F = F7*F;           % Keep track of F.
>> c = -B(2,3)/B(3,3); % Next, eliminate B(2,3).
>> F8 = eye(3); F8(2,3) = c;
>> B = F8*B           % Apply the matrix to B.

B =
     1     0     0
     0     1     0
     0     0    -10

>> F = F8*F;           % Keep track of F.
>> c = 1/B(3,3);       % finally, divide row 3 by B(3,3).
>> F9 = eye(3); F9(3,3) = c;
>> B = F9*B           % Apply the matrix to B.

B =
     1     0     0
     0     1     0
     0     0     1

>> F = F9*F           % Look at final form of F.

F =
   -0.7500    0.5000    0.2500
    0.3500   -0.3000    0.1500
    0.1000    0.2000   -0.1000

```

As in (b) and (c), we find that $F \cdot A = A \cdot F = I$, so F is the inverse of A , and that $D = \text{inv}(F1) \cdot \text{inv}(F2) \cdot \dots \cdot \text{inv}(F9)$ is the inverse of F , so it is the same as A .

3. (a)

```

>> A = [ 1 2 3; 1 1 7; 2 4 5];
>> U = A;           % Store A in U; after reduction U will be "echelon" form
>> c = -U(2,1)/U(1,1) % Eliminate U(2,1).
c =
    -1

>> F1 = eye(3); F1(2,1)=c
F1 =
     1     0     0
    -1     1     0
     0     0     1

>> U = F1*U           % Apply F1 to U, to eliminate.

>> c = -U(3,1)/U(1,1) % Eliminate U(3,1).
c =
    -2

>> F2 = eye(3); F2(3,1) = c
F2 =
     1     0     0
     0     1     0
    -2     0     1

>> U = F2*U           % Apply F2 to U.
U =
     1     2     3
     0    -1     4
     0     0    -1

```

Note: U is now upper triangular.

```

>> F = F2*F1           % F is the product of the elementary matrices.
F =
     1     0     0
    -1     1     0
    -2     0     1

```

(b)

```

>> L = inv(F1)*inv(F2)
L =
     1     0     0
     1     1     0
     2     0     1

```

The matrix L is lower triangular. For each of the entries below the diagonal in L , we see that it is the same value as $-c$, where c was the multiplier used to eliminate the same entry in A . In fact the entries are just the entries in the inverses $\text{inv}(F1)$, $\text{inv}(F2)$. Since we can recover $F1$, $F2$ from L (move down column 1 for each successive F_i).

(c)

```
>> L*U % This is the same as A.
ans =
     1     2     3
     1     1     7
     2     4     5
```

Since F is the product of the elementary matrices that reduce A to U , we know that $FA = U$. Since $L = F^{-1}$, we have $LU = LFA = F^{-1}FA = A$.

(d)

```
>> A = [6 2 7 3; 8 10 1 4; 10 7 6 8; 4 8 9 5];
>> U = A; % Store A in U, and work with U.
>> c = -U(2,1)/U(1,1) % Eliminate U(2,1).
c =
    -1.3333
>> F1 = eye(4); F1(2,1) = c
F1 =
    1.0000         0         0         0
   -1.3333     1.0000         0         0
         0         0     1.0000         0
         0         0         0     1.0000

>> U = F1*U;
>> c = -U(3,1)/U(1,1) % Eliminate U(3,1).
c =
    -1.6667
>> F2 = eye(4); F2(3,1) = c
F2 =
    1.0000         0         0         0
         0     1.0000         0         0
   -1.6667         0     1.0000         0
         0         0         0     1.0000

>> U = F2*U;
>> c = -U(4,1)/U(1,1) % Eliminate U(4,1). This finishes column 1.
c =
    -0.6667
>> F3 = eye(4); F3(4,1) = c
F3 =
    1.0000         0         0         0
         0     1.0000         0         0
         0         0     1.0000         0
   -0.6667         0         0     1.0000

>> U = F3*U
U =
    6.0000     2.0000     7.0000     3.0000
         0     7.3333    -8.3333         0
         0     3.6667    -5.6667     3.0000
         0     6.6667     4.3333     3.0000
```

```

>> c = -U(3,2)/U(2,2)           % Eliminate U(3,2), moving on to column 2.
c =
    -0.5000
>> F4 = eye(4); F4(3,2) = c
F4 =
    1.0000         0         0         0
         0     1.0000         0         0
         0    -0.5000     1.0000         0
         0         0         0     1.0000

>> U = F4*U;

>> c = -U(4,2)/U(2,2)           % Eliminate U(4,2), finish column 2.
c =
    -0.9091
>> F5 = eye(4); F5(4,2) = c
F5 =
    1.0000         0         0         0
         0     1.0000         0         0
         0         0     1.0000         0
         0    -0.9091         0     1.0000

>> U = F5*U
U =
    6.0000     2.0000     7.0000     3.0000
         0     7.3333    -8.3333         0
         0         0    -1.5000     3.0000
         0         0    11.9091     3.0000

>> c = -U(4,3)/U(3,3)           % Eliminate U(4,3), moving on to column 3.
c =
     7.9394
>> F6 = eye(4); F6(4,3) = c
F6 =
    1.0000         0         0         0
         0     1.0000         0         0
         0         0     1.0000         0
         0         0     7.9394     1.0000

>> U = F6*U
U =
    6.0000     2.0000     7.0000     3.0000
         0     7.3333    -8.3333         0
         0         0    -1.5000     3.0000
         0         0         0    26.8182

>> F = F6*F5*F4*F3*F2*F1       % The product of the F's
F =
    1.0000         0         0         0
   -1.3333     1.0000         0         0
   -1.0000    -0.5000     1.0000         0
   -7.3939    -4.8788     7.9394     1.0000

>> L = inv(F1)*inv(F2)*inv(F3)*inv(F4)*inv(F5)*inv(F6) % This is the inverse of F.

```

```
L =
    1.0000         0         0         0
    1.3333    1.0000         0         0
    1.6667    0.5000    1.0000         0
    0.6667    0.9091   -7.9394    1.0000
```

If you print `inv(Fi)` you see its non-zero entry below diagonal is just the negative of corresponding entry in `Fi` and is equal to corresponding entry in `L`.

```
>> L*U                                % As in (c), this is the same as A.
ans =
     6     2     7     3
     8    10     1     4
    10     7     6     8
     4     8     9     5
```

As in (b), we see that both L and F are lower triangular, and that $LU = A$. As in (c), each entry in L is the negative of the multiplier used to eliminate the corresponding entry in U , or the non-zero entries in `inv(F1), ..., inv(F6)`.

Section 1.11

In problems 1–8, the matrix L is constructed from the identity matrix in the following way: For each row operation on A of the form $R_i \rightarrow R_i - kR_j$, put a k in the i, j position of the identity matrix.

$$1. A = \begin{pmatrix} 1 & 2 \\ 3 & 4 \end{pmatrix} \xrightarrow{R_2 \rightarrow R_2 - 3R_1} \begin{pmatrix} 1 & 2 \\ 0 & -2 \end{pmatrix} = U. \text{ Thus } L = \begin{pmatrix} 1 & 0 \\ 3 & 1 \end{pmatrix}.$$

$$2. A = \begin{pmatrix} 1 & 2 \\ 0 & 3 \end{pmatrix} = U. \text{ Thus } L = \begin{pmatrix} 1 & 0 \\ 0 & 1 \end{pmatrix}.$$

$$3. A = \begin{pmatrix} -1 & 5 \\ 6 & 3 \end{pmatrix} \xrightarrow{R_2 \rightarrow R_2 + 6R_1} \begin{pmatrix} -1 & 5 \\ 0 & 33 \end{pmatrix} = U. \text{ Thus } L = \begin{pmatrix} 1 & 0 \\ -6 & 1 \end{pmatrix}.$$

$$4. A = \begin{pmatrix} 1 & 4 & 6 \\ 2 & -1 & 3 \\ 3 & 2 & 5 \end{pmatrix} \xrightarrow{R_2 \rightarrow R_2 - 2R_1} \begin{pmatrix} 1 & 4 & 6 \\ 0 & -9 & -9 \\ 3 & 2 & 5 \end{pmatrix} \xrightarrow{R_3 \rightarrow R_3 - 3R_1} \begin{pmatrix} 1 & 4 & 6 \\ 0 & -9 & -9 \\ 0 & -10 & -13 \end{pmatrix}$$

$$\xrightarrow{R_3 \rightarrow R_3 - \frac{10}{9}R_2} \begin{pmatrix} 1 & 4 & 6 \\ 0 & -9 & -9 \\ 0 & 0 & -3 \end{pmatrix} = U. \text{ Thus } L = \begin{pmatrix} 1 & 0 & 0 \\ 2 & 1 & 0 \\ 3 & \frac{10}{9} & 1 \end{pmatrix}.$$

$$5. A = \begin{pmatrix} 2 & 1 & 7 \\ 4 & 3 & 5 \\ 2 & 1 & 6 \end{pmatrix} \xrightarrow{R_3 \rightarrow R_3 - R_1} \begin{pmatrix} 2 & 1 & 7 \\ 4 & 3 & 5 \\ 0 & 0 & -1 \end{pmatrix} \xrightarrow{R_2 \rightarrow R_2 - 2R_1} \begin{pmatrix} 2 & 1 & 7 \\ 0 & 1 & -9 \\ 0 & 0 & -1 \end{pmatrix} = U.$$

$$\text{Thus } L = \begin{pmatrix} 1 & 0 & 0 \\ 2 & 1 & 0 \\ 1 & 0 & 1 \end{pmatrix}$$

$$6. A = \begin{pmatrix} 3 & 9 & -2 \\ 6 & -3 & 8 \\ 4 & 6 & 5 \end{pmatrix} \xrightarrow{R_2 \rightarrow R_2 - 2R_1} \begin{pmatrix} 3 & 9 & -2 \\ 0 & -21 & 12 \\ 4 & 6 & 5 \end{pmatrix} \xrightarrow{R_3 \rightarrow R_3 - \frac{4}{3}R_1} \begin{pmatrix} 3 & 9 & -2 \\ 0 & -21 & 12 \\ 0 & -6 & \frac{23}{3} \end{pmatrix}$$

$$\xrightarrow{R_3 \rightarrow R_3 - \frac{6}{21}R_2} \begin{pmatrix} 3 & 9 & -2 \\ 0 & -21 & 12 \\ 0 & 0 & \frac{89}{21} \end{pmatrix} = U. \text{ Thus } L = \begin{pmatrix} 1 & 0 & 0 \\ 2 & 1 & 0 \\ \frac{4}{3} & \frac{6}{21} & 1 \end{pmatrix}$$

$$7. A = \begin{pmatrix} 1 & 2 & -1 & 4 \\ 0 & -1 & 5 & 8 \\ 2 & 3 & 1 & 4 \\ 1 & -1 & 6 & 4 \end{pmatrix} \xrightarrow{R_3 \rightarrow R_3 - 2R_1} \begin{pmatrix} 1 & 2 & -1 & 4 \\ 0 & -1 & 5 & 8 \\ 0 & -1 & 3 & -4 \\ 1 & -1 & 6 & 4 \end{pmatrix} \xrightarrow{R_4 \rightarrow R_4 - R_1} \begin{pmatrix} 1 & 2 & -1 & 4 \\ 0 & -1 & 5 & 8 \\ 0 & -1 & 3 & -4 \\ 0 & -3 & 7 & 0 \end{pmatrix}$$

$$\xrightarrow{R_3 \rightarrow R_3 - R_2} \begin{pmatrix} 1 & 2 & -1 & 4 \\ 0 & -1 & 5 & 8 \\ 0 & 0 & -2 & -12 \\ 0 & -3 & 7 & 0 \end{pmatrix} \xrightarrow{R_4 \rightarrow R_4 - 3R_2} \begin{pmatrix} 1 & 2 & -1 & 4 \\ 0 & -1 & 5 & 8 \\ 0 & 0 & -2 & -12 \\ 0 & 0 & -8 & -24 \end{pmatrix} \xrightarrow{R_4 \rightarrow R_4 - 4R_3}$$

$$\begin{pmatrix} 1 & 2 & -1 & 4 \\ 0 & -1 & 5 & 8 \\ 0 & 0 & -2 & -12 \\ 0 & 0 & 0 & 24 \end{pmatrix} = U. \text{ Thus } L = \begin{pmatrix} 1 & 0 & 0 & 0 \\ 0 & 1 & 0 & 0 \\ 2 & 1 & 1 & 0 \\ 1 & 3 & 4 & 1 \end{pmatrix}.$$

$$\begin{aligned}
 8. \quad A &= \begin{pmatrix} 2 & 3 & -1 & 6 \\ 4 & 7 & 2 & 1 \\ -2 & 5 & -2 & 0 \\ 0 & -4 & 5 & 2 \end{pmatrix} \xrightarrow{R_2 \rightarrow R_2 - 2R_1} \begin{pmatrix} 2 & 3 & -1 & 6 \\ 0 & 1 & 4 & -11 \\ -2 & 5 & -2 & 0 \\ 0 & -4 & 5 & 2 \end{pmatrix} \xrightarrow{R_3 \rightarrow R_3 + R_1} \begin{pmatrix} 2 & 3 & -1 & 6 \\ 0 & 1 & 4 & -11 \\ 0 & 8 & -3 & 6 \\ 0 & -4 & 5 & 2 \end{pmatrix} \\
 &\xrightarrow{R_3 \rightarrow R_3 - 8R_2} \begin{pmatrix} 2 & 3 & -1 & 6 \\ 0 & 1 & 4 & -11 \\ 0 & 0 & -35 & 94 \\ 0 & -4 & 5 & 2 \end{pmatrix} \xrightarrow{R_4 \rightarrow R_4 + 4R_2} \begin{pmatrix} 2 & 3 & -1 & 6 \\ 0 & 1 & 4 & -11 \\ 0 & 0 & -35 & 94 \\ 0 & 0 & 21 & -42 \end{pmatrix} \xrightarrow{R_4 \rightarrow R_4 + \frac{3}{5}R_3} \begin{pmatrix} 2 & 3 & -1 & 6 \\ 0 & 1 & 4 & -11 \\ 0 & 0 & -35 & 94 \\ 0 & 0 & 0 & \frac{72}{5} \end{pmatrix} = \\
 U. \text{ Thus } L &= \begin{pmatrix} 1 & 0 & 0 & 0 \\ 2 & 1 & 0 & 0 \\ -1 & 8 & 1 & 0 \\ 0 & -4 & -\frac{3}{5} & 1 \end{pmatrix}.
 \end{aligned}$$

9. From problem 1 we have $A = LU$ where $L = \begin{pmatrix} 1 & 0 \\ 3 & 1 \end{pmatrix}$ and $U = \begin{pmatrix} 1 & 2 \\ 0 & -2 \end{pmatrix}$. The system $Ly = \mathbf{b}$, i.e., $\begin{pmatrix} 1 & 0 \\ 3 & 1 \end{pmatrix} \begin{pmatrix} y_1 \\ y_2 \end{pmatrix} = \begin{pmatrix} -2 \\ 4 \end{pmatrix}$ yields the equations $y_1 = -2$ and $3y_1 + y_2 = 4$. Solving we get $y_2 = 10$. Now, from $U\mathbf{x} = \mathbf{y}$, i.e., $\begin{pmatrix} 1 & 2 \\ 0 & -2 \end{pmatrix} \begin{pmatrix} x_1 \\ x_2 \end{pmatrix} = \begin{pmatrix} -2 \\ 10 \end{pmatrix}$ we obtain $x_1 + 2x_2 = -2$ and $-2x_2 = 10$. Backsolving we get $x_1 = 8$, $x_2 = -5$. The solution is $\begin{pmatrix} 8 \\ -5 \end{pmatrix}$.

10. From problem 2 we have $A = LU$ where $L = \begin{pmatrix} 1 & 0 \\ 0 & 1 \end{pmatrix}$ and $U = \begin{pmatrix} 1 & 2 \\ 0 & 3 \end{pmatrix}$. The system $Ly = \mathbf{b}$, i.e., $\begin{pmatrix} 1 & 0 \\ 0 & 1 \end{pmatrix} \begin{pmatrix} y_1 \\ y_2 \end{pmatrix} = \begin{pmatrix} -1 \\ 4 \end{pmatrix}$ yields the equations $y_1 = -1$, $y_2 = 4$. Now, from $U\mathbf{x} = \mathbf{y}$, i.e., $\begin{pmatrix} 1 & 2 \\ 0 & 3 \end{pmatrix} \begin{pmatrix} x_1 \\ x_2 \end{pmatrix} = \begin{pmatrix} -1 \\ 4 \end{pmatrix}$ we obtain $x_1 + 2x_2 = -1$ and $3x_2 = 4$. Backsolving we get $x_1 = \frac{-11}{3}$ and $x_2 = \frac{4}{3}$. The solution is $\begin{pmatrix} \frac{-11}{3} \\ \frac{4}{3} \end{pmatrix}$.

11. From problem 3 we have $A = LU$ where $L = \begin{pmatrix} 1 & 0 \\ -6 & 1 \end{pmatrix}$ and $U = \begin{pmatrix} -1 & 5 \\ 0 & 33 \end{pmatrix}$. The system $Ly = \mathbf{b}$, i.e., $\begin{pmatrix} 1 & 0 \\ -6 & 1 \end{pmatrix} \begin{pmatrix} y_1 \\ y_2 \end{pmatrix} = \begin{pmatrix} 0 \\ 5 \end{pmatrix}$ yields the equations $y_1 = 0$, $-6y_1 + y_2 = 5$. Solving we get $y_2 = 5$. Now, from $U\mathbf{x} = \mathbf{y}$, i.e., $\begin{pmatrix} -1 & 5 \\ 0 & 33 \end{pmatrix} \begin{pmatrix} x_1 \\ x_2 \end{pmatrix} = \begin{pmatrix} 0 \\ 5 \end{pmatrix}$ we obtain $-x_1 + 5x_2 = 0$, $33x_2 = 5$. Backsolving we get $x_1 = \frac{25}{33}$, $x_2 = \frac{5}{33}$. The solution is $\begin{pmatrix} \frac{25}{33} \\ \frac{5}{33} \end{pmatrix}$.

12. From problem 4 we have $A = LU$ where $L = \begin{pmatrix} 1 & 0 & 0 \\ 2 & 1 & 0 \\ 3 & \frac{10}{9} & 1 \end{pmatrix}$, $U = \begin{pmatrix} 1 & 4 & 6 \\ 0 & -9 & -9 \\ 0 & 0 & -3 \end{pmatrix}$. The system $Ly = \mathbf{b}$, i.e., $\begin{pmatrix} 1 & 0 & 0 \\ 2 & 1 & 0 \\ 3 & \frac{10}{9} & 1 \end{pmatrix} \begin{pmatrix} y_1 \\ y_2 \\ y_3 \end{pmatrix} = \begin{pmatrix} -1 \\ 7 \\ 2 \end{pmatrix}$ yields the equations $y_1 = -1$, $2y_1 + y_2 = 7$, $3y_1 + \frac{10}{9}y_2 + y_3 = 2$. Solving

we get $y_1 = -1$, $y_2 = 9$, $y_3 = -5$. Now, from $U\mathbf{x} = \mathbf{y}$, i.e., $\begin{pmatrix} 1 & 4 & 6 \\ 0 & -9 & -9 \\ 0 & 0 & -3 \end{pmatrix} \begin{pmatrix} x_1 \\ x_2 \\ x_3 \end{pmatrix} = \begin{pmatrix} -1 \\ 9 \\ -5 \end{pmatrix}$ we obtain

$x_1 + 4x_2 + 6x_3 = -1$, $-9x_2 - 9x_3 = 9$, $-3x_3 = -5$. Backsolving we get $x_1 = \frac{-1}{3}$, $x_2 = \frac{-8}{3}$, $x_3 = \frac{5}{3}$.

The solution is $\begin{pmatrix} \frac{-1}{3} \\ \frac{-8}{3} \\ \frac{5}{3} \end{pmatrix}$.

13. From problem 5 we have $A = LU$ where $L = \begin{pmatrix} 1 & 0 & 0 \\ 2 & 1 & 0 \\ 1 & 0 & 1 \end{pmatrix}$ and $U = \begin{pmatrix} 2 & 1 & 7 \\ 0 & 1 & -9 \\ 0 & 0 & -1 \end{pmatrix}$. The system $L\mathbf{y} = \mathbf{b}$,

i.e., $\begin{pmatrix} 1 & 0 & 0 \\ 2 & 1 & 0 \\ 1 & 0 & 1 \end{pmatrix} \begin{pmatrix} y_1 \\ y_2 \\ y_3 \end{pmatrix} = \begin{pmatrix} 6 \\ 1 \\ 1 \end{pmatrix}$ yields the equations $y_1 = 6$, $2y_1 + y_2 = 1$, $y_1 + y_3 = 1$. Solving we

get $y_1 = 6$, $y_2 = -11$, $y_3 = -5$. Now, from $U\mathbf{x} = \mathbf{y}$, i.e., $\begin{pmatrix} 2 & 1 & 7 \\ 0 & 1 & -9 \\ 0 & 0 & -1 \end{pmatrix} \begin{pmatrix} x_1 \\ x_2 \\ x_3 \end{pmatrix} = \begin{pmatrix} 6 \\ -11 \\ -5 \end{pmatrix}$ we obtain

$2x_1 + x_2 + 7x_3 = 6$, $x_2 - 9x_3 = -11$, $-x_3 = -5$. Backsolving we get $x_1 = \frac{-63}{2}$, $x_2 = 34$, $x_3 = 5$. The

solution is $\begin{pmatrix} \frac{-63}{2} \\ 34 \\ 5 \end{pmatrix}$.

14. From problem 6 we have $A = LU$ where $L = \begin{pmatrix} 1 & 0 & 0 \\ 2 & 1 & 0 \\ \frac{4}{3} & \frac{6}{21} & 1 \end{pmatrix}$ and $U = \begin{pmatrix} 3 & 9 & -2 \\ 0 & -21 & 12 \\ 0 & 0 & \frac{9}{21} \end{pmatrix}$. The system $L\mathbf{y} =$

\mathbf{b} , i.e., $\begin{pmatrix} 1 & 0 & 0 \\ 2 & 1 & 0 \\ \frac{4}{3} & \frac{6}{21} & 1 \end{pmatrix} \begin{pmatrix} y_1 \\ y_2 \\ y_3 \end{pmatrix} = \begin{pmatrix} 3 \\ 16 \\ 4 \end{pmatrix}$ yields the equations $y_1 = 3$, $2y_1 + y_2 = 10$, $\frac{4}{3}y_1 + \frac{2}{7}y_2 + y_3 = 4$.

Backsolving we get $y_1 = 3$, $y_2 = 4$, $y_3 = \frac{-8}{7}$. Now, from $U\mathbf{x} = \mathbf{y}$, i.e., $\begin{pmatrix} 3 & 9 & -2 \\ 0 & -21 & 12 \\ 0 & 0 & \frac{9}{21} \end{pmatrix} \begin{pmatrix} x_1 \\ x_2 \\ x_3 \end{pmatrix} =$

$\begin{pmatrix} 3 \\ 4 \\ \frac{-8}{7} \end{pmatrix}$ we obtain $3x_1 + 9x_2 - 2x_3 = 3$, $-21x_2 + 12x_3 = 4$, $\frac{9}{21}x_3 = \frac{-8}{7}$. Solving we get $x_1 = \frac{275}{63}$, $x_2 =$

$\frac{-12}{7}$, $x_3 = \frac{-8}{3}$. The solution is $\begin{pmatrix} 275/63 \\ -12/7 \\ -8/3 \end{pmatrix}$.

15. From problem 7 we have $A = LU$ where $L = \begin{pmatrix} 1 & 0 & 0 & 0 \\ 0 & 1 & 0 & 0 \\ 2 & 1 & 1 & 0 \\ 1 & 3 & 4 & 1 \end{pmatrix}$ and $U = \begin{pmatrix} 1 & 2 & -1 & 4 \\ 0 & -1 & 5 & 8 \\ 0 & 0 & -2 & -12 \\ 0 & 0 & 0 & 24 \end{pmatrix}$. The system

$L\mathbf{y} = \mathbf{b}$, i.e., $\begin{pmatrix} 1 & 0 & 0 & 0 \\ 0 & 1 & 0 & 0 \\ 2 & 1 & 1 & 0 \\ 1 & 3 & 4 & 1 \end{pmatrix} \begin{pmatrix} y_1 \\ y_2 \\ y_3 \\ y_4 \end{pmatrix} = \begin{pmatrix} 3 \\ -11 \\ 4 \\ -5 \end{pmatrix}$ yields the equations $y_1 = 3$, $y_2 = -11$, $2y_1 + y_2 + y_3 =$

4 , $y_1 + 3y_2 + 4y_3 + y_4 = -5$. Solving we get $y_1 = 3$, $y_2 = -11$, $y_3 = 9$, $y_4 = -11$. Now, from $U\mathbf{x} = \mathbf{y}$,

i.e., $\begin{pmatrix} 1 & 2 & -1 & 4 \\ 0 & -1 & 5 & 8 \\ 0 & 0 & -2 & -12 \\ 0 & 0 & 0 & 24 \end{pmatrix} \begin{pmatrix} x_1 \\ x_2 \\ x_3 \\ x_4 \end{pmatrix} = \begin{pmatrix} 3 \\ -11 \\ 9 \\ -11 \end{pmatrix}$ we obtain $x_1 + 2x_2 - x_3 + 4x_4 = 3$, $-x_2 + 5x_3 + 8x_4 = -11$,

$-2x_3 - 12x_4 = 9$, $24x_4 = -11$. Backsolving we get $x_1 = \frac{71}{12}$, $x_2 = \frac{-17}{12}$, $x_3 = \frac{-7}{4}$, $x_4 = \frac{-11}{24}$. The

solution is $\begin{pmatrix} 71/12 \\ -17/12 \\ -7/4 \\ -11/24 \end{pmatrix}$.

16. From problem 8 we have $A = LU$ where $L = \begin{pmatrix} 1 & 0 & 0 & 0 \\ 2 & 1 & 0 & 0 \\ -1 & 8 & 1 & 0 \\ 0 & -4 & -\frac{3}{5} & 1 \end{pmatrix}$ and $U = \begin{pmatrix} 2 & 3 & -1 & 6 \\ 0 & 1 & 4 & -11 \\ 0 & 0 & -35 & 94 \\ 0 & 0 & 0 & \frac{72}{5} \end{pmatrix}$. The

system $Ly = \mathbf{b}$, that is, $\begin{pmatrix} 1 & 0 & 0 & 0 \\ 2 & 1 & 0 & 0 \\ -1 & 8 & 1 & 0 \\ 0 & -4 & -\frac{3}{5} & 1 \end{pmatrix} \begin{pmatrix} y_1 \\ y_2 \\ y_3 \\ y_4 \end{pmatrix} = \begin{pmatrix} 1 \\ 0 \\ 0 \\ 4 \end{pmatrix}$ yields the equations $y_1 = 1$, $2y_1 + y_2 = 0$,

$-y_1 + 8y_2 + y_3 = 0$, $-4y_2 - \frac{3}{5}y_3 + y_4 = 4$. Solving we get $y_1 = 1$, $y_2 = -2$, $y_3 = 17$, $y_4 = \frac{31}{5}$. Now from

$U\mathbf{x} = \mathbf{y}$, i.e., $\begin{pmatrix} 2 & 3 & -1 & 6 \\ 0 & 1 & 4 & -11 \\ 0 & 0 & -35 & 94 \\ 0 & 0 & 0 & \frac{72}{5} \end{pmatrix} \begin{pmatrix} x_1 \\ x_2 \\ x_3 \\ x_4 \end{pmatrix} = \begin{pmatrix} 1 \\ -2 \\ 17 \\ \frac{31}{5} \end{pmatrix}$ we obtain $2x_1 + 3x_2 - x_3 + 6x_4 = 1$, $x_2 + 4x_3 - 11x_4 =$

-2 , $-35x_3 + 94x_4 = 17$, $\frac{72}{5}x_4 = \frac{31}{5}$. Solving we get $x_1 = \frac{-565}{1008}$, $x_2 = \frac{5}{72}$, $x_3 = \frac{169}{252}$, $x_4 = \frac{31}{72}$. The

solution is $\begin{pmatrix} -565/1008 \\ 5/72 \\ 169/252 \\ 31/72 \end{pmatrix}$.

17. (a) $\begin{pmatrix} 0 & 2 \\ 1 & 4 \end{pmatrix} \xrightarrow{R_1 \leftrightarrow R_2} \begin{pmatrix} 1 & 4 \\ 0 & 2 \end{pmatrix} = U$. Thus $P = \begin{pmatrix} 0 & 1 \\ 1 & 0 \end{pmatrix}$. $PA = \begin{pmatrix} 0 & 1 \\ 1 & 0 \end{pmatrix} \begin{pmatrix} 0 & 2 \\ 1 & 4 \end{pmatrix} = \begin{pmatrix} 1 & 4 \\ 0 & 2 \end{pmatrix} = U$ or $PA = LU$ where $L = \begin{pmatrix} 1 & 0 \\ 0 & 1 \end{pmatrix}$.

b) $LU\mathbf{x} = PA\mathbf{x} = P\mathbf{b} = \begin{pmatrix} 0 & 1 \\ 1 & 0 \end{pmatrix} \begin{pmatrix} 3 \\ -5 \end{pmatrix} = \begin{pmatrix} -5 \\ 3 \end{pmatrix}$. We seek a \mathbf{y} such that $Ly = \begin{pmatrix} -5 \\ 3 \end{pmatrix}$. From

$Ly = \begin{pmatrix} 1 & 0 \\ 0 & 1 \end{pmatrix} \begin{pmatrix} y_1 \\ y_2 \end{pmatrix} = \begin{pmatrix} -5 \\ 3 \end{pmatrix}$ we get $y_1 = -5$, $y_2 = 3$ and hence $\mathbf{y} = \begin{pmatrix} -5 \\ 3 \end{pmatrix}$. Now, we seek an \mathbf{x} such

that $U\mathbf{x} = \mathbf{y} = \begin{pmatrix} -5 \\ 3 \end{pmatrix}$. That is $\begin{pmatrix} 1 & 4 \\ 0 & 2 \end{pmatrix} \begin{pmatrix} x_1 \\ x_2 \end{pmatrix} = \begin{pmatrix} -5 \\ 3 \end{pmatrix}$. We get $x_1 + 4x_2 = -5$ and $2x_2 = 3$. Solving

we get $x_1 = -11$, $x_2 = \frac{3}{2}$. The solution is $\begin{pmatrix} -11 \\ \frac{3}{2} \end{pmatrix}$.

18. (a) $\begin{pmatrix} 0 & 2 & 4 \\ 1 & -1 & 2 \\ 0 & 3 & 2 \end{pmatrix} \xrightarrow{R_2 \leftrightarrow R_1} \begin{pmatrix} 1 & -1 & 2 \\ 0 & 2 & 4 \\ 0 & 3 & 2 \end{pmatrix} \xrightarrow{R_3 \rightarrow \frac{3}{2}R_2} \begin{pmatrix} 1 & -1 & 2 \\ 0 & 2 & 4 \\ 0 & 0 & -4 \end{pmatrix}$. Then $P = \begin{pmatrix} 0 & 1 & 0 \\ 1 & 0 & 0 \\ 0 & 0 & 1 \end{pmatrix}$, and $PA = \begin{pmatrix} 1 & -1 & 2 \\ 0 & 2 & 4 \\ 0 & 3 & 2 \end{pmatrix}$. Now we row reduce PA to an upper triangular matrix. $\begin{pmatrix} 1 & -1 & 2 \\ 0 & 2 & 4 \\ 0 & 3 & 2 \end{pmatrix}$

$R_3 \rightarrow R_3 - \frac{3}{2}R_2 \xrightarrow{\hspace{1cm}} \begin{pmatrix} 1 & -1 & 2 \\ 0 & 2 & 4 \\ 0 & 0 & -4 \end{pmatrix} = U$. Thus $PA = LU$ where $L = \begin{pmatrix} 1 & 0 & 0 \\ 0 & 1 & 0 \\ 0 & \frac{3}{2} & 1 \end{pmatrix}$.

b) $LU\mathbf{x} = PA\mathbf{x} = P\mathbf{b} = \begin{pmatrix} 0 & 1 & 0 \\ 1 & 0 & 0 \\ 0 & 0 & 1 \end{pmatrix} \begin{pmatrix} -1 \\ 2 \\ 4 \end{pmatrix} = \begin{pmatrix} 2 \\ -1 \\ 4 \end{pmatrix}$. We seek a \mathbf{y} such that $L\mathbf{y} = \begin{pmatrix} 2 \\ -1 \\ 4 \end{pmatrix}$. From

$L\mathbf{y} = \begin{pmatrix} 1 & 0 & 0 \\ 0 & 1 & 0 \\ 0 & \frac{3}{2} & 1 \end{pmatrix} \begin{pmatrix} y_1 \\ y_2 \\ y_3 \end{pmatrix} = \begin{pmatrix} 2 \\ -1 \\ 4 \end{pmatrix}$ we get $y_1 = 2, y_2 = -1, \frac{3}{2}y_2 + y_3 = 4$. Solving we get $y_3 = \frac{11}{2}$,

and thus $\mathbf{y} = \begin{pmatrix} 2 \\ -1 \\ 11/2 \end{pmatrix}$. We seek an \mathbf{x} such that $U\mathbf{x} = \begin{pmatrix} 2 \\ -1 \\ 11/2 \end{pmatrix}$. That is $\begin{pmatrix} 1 & -1 & 2 \\ 0 & 2 & 4 \\ 0 & 0 & -4 \end{pmatrix} \begin{pmatrix} x_1 \\ x_2 \\ x_3 \end{pmatrix} =$

$\begin{pmatrix} 2 \\ -1 \\ 11/2 \end{pmatrix}$. We get $x_1 - x_2 + 2x_3 = 2, 2x_2 + 4x_3 = -1, -4x_3 = \frac{11}{2}$. Solving we get $x_1 = 7, x_2 = \frac{9}{4}, x_3 =$

$\frac{-11}{8}$. The solution is $\begin{pmatrix} 7 \\ 9/4 \\ -11/8 \end{pmatrix}$.

19. (a) $\begin{pmatrix} 0 & 2 & 4 \\ 0 & 3 & 7 \\ 4 & 1 & 5 \end{pmatrix} \xrightarrow{R_1 \leftrightarrow R_3} \begin{pmatrix} 4 & 1 & 5 \\ 0 & 3 & 7 \\ 0 & 2 & 4 \end{pmatrix} \xrightarrow{R_3 \rightarrow R_3 - \frac{2}{3}R_2} \begin{pmatrix} 4 & 1 & 5 \\ 0 & 3 & 7 \\ 0 & 0 & \frac{-2}{3} \end{pmatrix}$. Then $P = \begin{pmatrix} 0 & 0 & 1 \\ 0 & 1 & 0 \\ 1 & 0 & 0 \end{pmatrix}$, and $PA = \begin{pmatrix} 4 & 1 & 5 \\ 0 & 3 & 7 \\ 0 & 2 & 4 \end{pmatrix}$. $R_3 \rightarrow R_3 - \frac{2}{3}R_2 \xrightarrow{\hspace{1cm}} \begin{pmatrix} 4 & 1 & 5 \\ 0 & 3 & 7 \\ 0 & 0 & \frac{-2}{3} \end{pmatrix} = U$. Thus $PA = LU$ where $L = \begin{pmatrix} 1 & 0 & 0 \\ 0 & 1 & 0 \\ 0 & \frac{2}{3} & 1 \end{pmatrix}$.

b) $LU\mathbf{x} = PA\mathbf{x} = P\mathbf{b} = \begin{pmatrix} 0 & 0 & 1 \\ 0 & 1 & 0 \\ 1 & 0 & 0 \end{pmatrix} \begin{pmatrix} -1 \\ 0 \\ 2 \end{pmatrix} = \begin{pmatrix} 2 \\ 0 \\ -1 \end{pmatrix}$. We seek a \mathbf{y} such that $L\mathbf{y} = \begin{pmatrix} 2 \\ 0 \\ -1 \end{pmatrix}$. From

$L\mathbf{y} = \begin{pmatrix} 1 & 0 & 0 \\ 0 & 1 & 0 \\ 0 & \frac{2}{3} & 1 \end{pmatrix} \begin{pmatrix} y_1 \\ y_2 \\ y_3 \end{pmatrix} = \begin{pmatrix} 2 \\ 0 \\ -1 \end{pmatrix}$ we get $y_1 = 2, y_2 = 0, \frac{2}{3}y_2 + y_3 = -1$. Solving we get $y_3 = -1$, and

thus $\mathbf{y} = \begin{pmatrix} 2 \\ 0 \\ -1 \end{pmatrix}$. Now, we find an \mathbf{x} such that $U\mathbf{x} = \begin{pmatrix} 2 \\ 0 \\ -1 \end{pmatrix}$. That is $\begin{pmatrix} 4 & 1 & 5 \\ 0 & 3 & 7 \\ 0 & 0 & \frac{-2}{3} \end{pmatrix} \begin{pmatrix} x_1 \\ x_2 \\ x_3 \end{pmatrix} = \begin{pmatrix} 2 \\ 0 \\ -1 \end{pmatrix}$.

We get $4x_1 + x_2 + 5x_3 = 2, 3x_2 + 7x_3 = 0, \frac{-2}{3}x_3 = -1$. Backsolving we get $x_1 = \frac{-1}{2}, x_2 = \frac{-7}{2}, x_3 = \frac{3}{2}$.

The solution is $\begin{pmatrix} -1/2 \\ -7/2 \\ 3/2 \end{pmatrix}$.

$$20. (a) \begin{pmatrix} 0 & 5 & -1 \\ 2 & 3 & 5 \\ 4 & 6 & -7 \end{pmatrix} \xrightarrow{R_1 \leftrightarrow R_2} \begin{pmatrix} 2 & 3 & 5 \\ 0 & 5 & -1 \\ 4 & 6 & -7 \end{pmatrix} \xrightarrow{R_3 \rightarrow R_3 - 2R_1} \begin{pmatrix} 2 & 3 & 5 \\ 0 & 5 & -1 \\ 0 & 0 & -17 \end{pmatrix}. \text{ Then } P = \begin{pmatrix} 0 & 1 & 0 \\ 1 & 0 & 0 \\ 0 & 0 & 1 \end{pmatrix} \text{ and } PA =$$

$$\begin{pmatrix} 2 & 3 & 5 \\ 0 & 5 & -1 \\ 4 & 6 & -7 \end{pmatrix} \xrightarrow{R_3 \rightarrow R_3 - 2R_1} \begin{pmatrix} 2 & 3 & 5 \\ 0 & 5 & -1 \\ 0 & 0 & -17 \end{pmatrix} = U. \text{ Thus } PA = LU \text{ where } L = \begin{pmatrix} 1 & 0 & 0 \\ 0 & 1 & 0 \\ 2 & 0 & 1 \end{pmatrix}.$$

b) $LU\mathbf{x} = PA\mathbf{x} = P\mathbf{b} = \begin{pmatrix} 0 & 1 & 0 \\ 1 & 0 & 0 \\ 0 & 0 & 1 \end{pmatrix} \begin{pmatrix} 10 \\ -3 \\ 5 \end{pmatrix} = \begin{pmatrix} -3 \\ 10 \\ 5 \end{pmatrix}$. We seek a \mathbf{y} such that $L\mathbf{y} = \begin{pmatrix} -3 \\ 10 \\ 5 \end{pmatrix}$. From

$$L\mathbf{y} = \begin{pmatrix} 1 & 0 & 0 \\ 0 & 1 & 0 \\ 2 & 0 & 1 \end{pmatrix} \begin{pmatrix} y_1 \\ y_2 \\ y_3 \end{pmatrix} = \begin{pmatrix} -3 \\ 10 \\ 5 \end{pmatrix} \text{ we get } y_1 = -3, y_2 = 10, 2y_1 + y_3 = 5. \text{ Solving we get } y_3 = 11 \text{ and}$$

$$\mathbf{y} = \begin{pmatrix} -3 \\ 10 \\ 11 \end{pmatrix}. \text{ Now, we find an } \mathbf{x} \text{ such that } U\mathbf{x} = \begin{pmatrix} -3 \\ 10 \\ 11 \end{pmatrix}. \text{ That is } \begin{pmatrix} 2 & 3 & 5 \\ 0 & 5 & -1 \\ 0 & 0 & -17 \end{pmatrix} \begin{pmatrix} x_1 \\ x_2 \\ x_3 \end{pmatrix} = \begin{pmatrix} -3 \\ 10 \\ 11 \end{pmatrix}. \text{ We}$$

get $2x_1 + 3x_2 + 5x_3 = -3$, $5x_2 - x_3 = 10$, $-17x_3 = 11$. Solving we get $x_1 = \frac{-457}{170}$, $x_2 = \frac{159}{85}$, $x_3 = \frac{-11}{17}$.

The solution is $\begin{pmatrix} -457/170 \\ 159/85 \\ -11/17 \end{pmatrix}$.

$$21. (a) \begin{pmatrix} 0 & 2 & 3 & 1 \\ 0 & 4 & -1 & 5 \\ 2 & 0 & 3 & 1 \\ 1 & -4 & 5 & 6 \end{pmatrix} \xrightarrow{R_2 \rightarrow R_2 - 2R_1} \begin{pmatrix} 0 & 2 & 3 & 1 \\ 0 & 0 & -7 & 3 \\ 2 & 0 & 3 & 1 \\ 1 & -4 & 5 & 6 \end{pmatrix} \xrightarrow{R_3 \leftrightarrow R_4} \begin{pmatrix} 0 & 2 & 3 & 1 \\ 0 & 0 & -7 & 3 \\ 1 & -4 & 5 & 6 \\ 2 & 0 & 3 & 1 \end{pmatrix}$$

$$\xrightarrow{R_4 \rightarrow R_4 - 2R_3} \begin{pmatrix} 0 & 2 & 3 & 1 \\ 0 & 0 & -7 & 3 \\ 1 & -4 & 5 & 6 \\ 0 & 8 & -7 & -11 \end{pmatrix} \xrightarrow{R_4 \rightarrow R_4 - 4R_1} \begin{pmatrix} 0 & 2 & 3 & 1 \\ 0 & 0 & -7 & 3 \\ 1 & -4 & 5 & 6 \\ 0 & 0 & -19 & -15 \end{pmatrix} \xrightarrow{R_4 \rightarrow R_4 - \frac{19}{7}R_2}$$

$$\begin{pmatrix} 0 & 2 & 3 & 1 \\ 0 & 0 & -7 & 3 \\ 1 & -4 & 5 & 6 \\ 0 & 0 & 0 & \frac{-162}{7} \end{pmatrix} \xrightarrow{R_1 \leftrightarrow R_3} \begin{pmatrix} 1 & -4 & 5 & 6 \\ 0 & 0 & -7 & 3 \\ 0 & 2 & 3 & 1 \\ 0 & 0 & 0 & \frac{-162}{7} \end{pmatrix} \xrightarrow{R_2 \leftrightarrow R_3} \begin{pmatrix} 1 & -4 & 5 & 6 \\ 0 & 2 & 3 & 1 \\ 0 & 0 & -7 & 3 \\ 0 & 0 & 0 & \frac{-162}{7} \end{pmatrix}. \text{ Then } P = \begin{pmatrix} 0 & 0 & 0 & 1 \\ 1 & 0 & 0 & 0 \\ 0 & 1 & 0 & 0 \\ 0 & 0 & 1 & 0 \end{pmatrix}$$

and $PA = \begin{pmatrix} 1 & -4 & 5 & 6 \\ 0 & 2 & 3 & 1 \\ 0 & 4 & -1 & 5 \\ 2 & 0 & 3 & 1 \end{pmatrix} \xrightarrow{R_3 \rightarrow R_3 - 2R_2} \begin{pmatrix} 1 & -4 & 5 & 6 \\ 0 & 2 & 3 & 1 \\ 0 & 0 & -7 & 3 \\ 2 & 0 & 3 & 1 \end{pmatrix} \xrightarrow{R_4 \rightarrow R_4 - 2R_1} \begin{pmatrix} 1 & -4 & 5 & 6 \\ 0 & 2 & 3 & 1 \\ 0 & 0 & -7 & 3 \\ 0 & 8 & -7 & -11 \end{pmatrix}$

$$\xrightarrow{R_4 \rightarrow R_4 - 4R_2} \begin{pmatrix} 1 & -4 & 5 & 6 \\ 0 & 2 & 3 & 1 \\ 0 & 0 & -7 & 3 \\ 0 & 0 & -19 & -15 \end{pmatrix} \xrightarrow{R_4 \rightarrow R_4 - \frac{19}{7}R_3}$$

$$\begin{pmatrix} 1 & -4 & 5 & 6 \\ 0 & 2 & 3 & 1 \\ 0 & 0 & -7 & 3 \\ 0 & 0 & 0 & \frac{-162}{7} \end{pmatrix} = U. \text{ Thus } PA = LU \text{ where } L = \begin{pmatrix} 1 & 0 & 0 & 0 \\ 0 & 1 & 0 & 0 \\ 0 & 2 & 1 & 0 \\ 2 & 4 & \frac{19}{7} & 1 \end{pmatrix}.$$

b) $LU\mathbf{x} = P\mathbf{Ax} = P\mathbf{b} = \begin{pmatrix} 0 & 0 & 0 & 1 \\ 1 & 0 & 0 & 0 \\ 0 & 1 & 0 & 0 \\ 0 & 0 & 1 & 0 \end{pmatrix} \begin{pmatrix} 3 \\ -1 \\ 2 \\ 4 \end{pmatrix} = \begin{pmatrix} 4 \\ 3 \\ -1 \\ 2 \end{pmatrix}$. We seek a \mathbf{y} such that $L\mathbf{y} = \begin{pmatrix} 4 \\ 3 \\ -1 \\ 2 \end{pmatrix}$. From

$$L\mathbf{y} = \begin{pmatrix} 1 & 0 & 0 & 0 \\ 0 & 1 & 0 & 0 \\ 0 & 2 & 1 & 0 \\ 2 & 4 & \frac{19}{7} & 1 \end{pmatrix} \begin{pmatrix} y_1 \\ y_2 \\ y_3 \\ y_4 \end{pmatrix} = \begin{pmatrix} 4 \\ 3 \\ -1 \\ 2 \end{pmatrix} \text{ we get } y_1 = 4, y_2 = 3, 2y_2 + y_3 = -1, 2y_1 + 4y_2 + \frac{19}{7}y_3 + y_4 = 2.$$

Solving we get $y_3 = -7, y_4 = 1$, and $\mathbf{y} = \begin{pmatrix} 4 \\ 3 \\ -7 \\ 1 \end{pmatrix}$. Now, we find an \mathbf{x} such that $U\mathbf{x} = \begin{pmatrix} 4 \\ 3 \\ -7 \\ 1 \end{pmatrix}$. That

is $\begin{pmatrix} 1 & -4 & 5 & 6 \\ 0 & 2 & 3 & 1 \\ 0 & 0 & -7 & 3 \\ 0 & 0 & 0 & \frac{-162}{7} \end{pmatrix} \begin{pmatrix} x_1 \\ x_2 \\ x_3 \\ x_4 \end{pmatrix} = \begin{pmatrix} 4 \\ 3 \\ -7 \\ 1 \end{pmatrix}$. We get $x_1 - 4x_2 + 5x_3 + 6x_4 = 4, 2x_2 + 3x_3 + x_4 = 3,$

$-7x_3 + 3x_4 = -7, \frac{-162}{7}x_4 = 1$. Backsolving we get $x_1 = \frac{-73}{162}, x_2 = \frac{4}{81}, x_3 = \frac{53}{54}, x_4 = \frac{-7}{162}$. The

solution is $\begin{pmatrix} -73/162 \\ 4/81 \\ 53/54 \\ -7/162 \end{pmatrix}$.

22. (a) $\begin{pmatrix} 0 & 0 & -2 & 3 \\ 5 & 0 & -6 & 4 \\ 2 & 0 & 1 & -2 \\ 0 & 4 & -2 & 5 \end{pmatrix} \xrightarrow{R_1 \leftrightarrow R_4} \begin{pmatrix} 0 & 4 & -2 & 5 \\ 5 & 0 & -6 & 4 \\ 2 & 0 & 1 & -2 \\ 0 & 0 & -2 & 3 \end{pmatrix} \xrightarrow{R_3 \rightarrow R_3 - \frac{2}{5}R_2} \begin{pmatrix} 0 & 4 & -2 & 5 \\ 5 & 0 & -6 & 4 \\ 0 & 0 & \frac{17}{5} & \frac{-18}{5} \\ 0 & 0 & -2 & 3 \end{pmatrix}$

$\xrightarrow{R_1 \leftrightarrow R_2} \begin{pmatrix} 5 & 0 & -6 & 4 \\ 0 & 4 & -2 & 5 \\ 0 & 0 & \frac{17}{5} & \frac{-18}{5} \\ 0 & 0 & -2 & 3 \end{pmatrix} \xrightarrow{R_4 \rightarrow R_4 + \frac{10}{17}R_3} \begin{pmatrix} 5 & 0 & -6 & 4 \\ 0 & 4 & -2 & 5 \\ 0 & 0 & \frac{17}{5} & \frac{-18}{5} \\ 0 & 0 & 0 & \frac{15}{17} \end{pmatrix}$. Then $P = \begin{pmatrix} 0 & 1 & 0 & 0 \\ 0 & 0 & 0 & 1 \\ 0 & 0 & 1 & 0 \\ 1 & 0 & 0 & 0 \end{pmatrix}$ and $PA = \begin{pmatrix} 5 & 0 & -6 & 4 \\ 0 & 4 & -2 & 5 \\ 2 & 0 & 1 & -2 \\ 0 & 0 & -2 & 3 \end{pmatrix}$

$\xrightarrow{R_3 \rightarrow R_3 - \frac{2}{5}R_1} \begin{pmatrix} 5 & 0 & -6 & 4 \\ 0 & 4 & -2 & 5 \\ 0 & 0 & \frac{17}{5} & \frac{-18}{5} \\ 0 & 0 & -2 & 3 \end{pmatrix} \xrightarrow{R_4 \rightarrow R_4 + \frac{10}{17}R_3}$

$\begin{pmatrix} 5 & 0 & -6 & 4 \\ 0 & 4 & -2 & 5 \\ 0 & 0 & \frac{17}{5} & \frac{-18}{5} \\ 0 & 0 & 0 & \frac{15}{17} \end{pmatrix} = U$. Thus $PA = LU$ where $L = \begin{pmatrix} 1 & 0 & 0 & 0 \\ 0 & 1 & 0 & 0 \\ \frac{2}{5} & 0 & 1 & 0 \\ 0 & 0 & \frac{-10}{17} & 1 \end{pmatrix}$.

b) $LU\mathbf{x} = P\mathbf{Ax} = P\mathbf{b} = \begin{pmatrix} 0 & 1 & 0 & 0 \\ 0 & 0 & 0 & 1 \\ 0 & 0 & 1 & 0 \\ 1 & 0 & 0 & 0 \end{pmatrix} \begin{pmatrix} -2 \\ 4 \\ 5 \\ 7 \end{pmatrix} = \begin{pmatrix} 4 \\ 7 \\ 5 \\ -2 \end{pmatrix}$. We seek a \mathbf{y} such that $L\mathbf{y} = \begin{pmatrix} 4 \\ 7 \\ 5 \\ -2 \end{pmatrix}$. From

$$L\mathbf{y} = \begin{pmatrix} 1 & 0 & 0 & 0 \\ 0 & 1 & 0 & 0 \\ \frac{2}{5} & 0 & 1 & 0 \\ 0 & 0 & -\frac{10}{17} & 1 \end{pmatrix} \begin{pmatrix} y_1 \\ y_2 \\ y_3 \\ y_4 \end{pmatrix} = \begin{pmatrix} 4 \\ 7 \\ 5 \\ -2 \end{pmatrix} \text{ we get } y_1 = 4, y_2 = 7, \frac{2}{5}y_1 + y_3 = 5, \frac{-10}{17}y_3 + y_4 = -2.$$

Solving we get $y_3 = \frac{17}{5}, y_4 = 0$, and $\mathbf{y} = \begin{pmatrix} 4 \\ 7 \\ 17/5 \\ 0 \end{pmatrix}$. Now, find an \mathbf{x} such that $U\mathbf{x} = \begin{pmatrix} 4 \\ 7 \\ 17/5 \\ 0 \end{pmatrix}$.

That is $\begin{pmatrix} 5 & 0 & -6 & 4 \\ 0 & 4 & -2 & 5 \\ 0 & 0 & \frac{17}{5} & -\frac{18}{5} \\ 0 & 0 & 0 & \frac{15}{17} \end{pmatrix} \begin{pmatrix} x_1 \\ x_2 \\ x_3 \\ x_4 \end{pmatrix} = \begin{pmatrix} 4 \\ 7 \\ 17/5 \\ 0 \end{pmatrix}$. We get $5x_1 - 6x_3 + 4x_4 = 4$, $4x_2 - 2x_3 + 5x_4 = 7$,

$\frac{17}{5}x_3 - \frac{18}{5}x_4 = \frac{17}{5}$, $\frac{15}{17}x_4 = 0$. Solving we get $x_1 = 2$, $x_2 = \frac{9}{4}$, $x_3 = 1$, $x_4 = 0$. The solution is $\begin{pmatrix} 2 \\ 9/4 \\ 1 \\ 0 \end{pmatrix}$.

$$\begin{aligned}
 23. \text{ (a)} \quad & \begin{pmatrix} 0 & -2 & 3 & 1 \\ 0 & 4 & -3 & 2 \\ 1 & 2 & -3 & 2 \\ -2 & -4 & 5 & -10 \end{pmatrix} \xrightarrow{R_4 \rightarrow R_4 + 2R_3} \begin{pmatrix} 0 & -2 & 3 & 1 \\ 0 & 4 & -3 & 2 \\ 1 & 2 & -3 & 2 \\ 0 & 0 & -1 & -6 \end{pmatrix} \xrightarrow{R_2 \rightarrow R_2 + 2R_1} \begin{pmatrix} 0 & -2 & 3 & 1 \\ 0 & 0 & 3 & 4 \\ 1 & 2 & -3 & 2 \\ 0 & 0 & -1 & -6 \end{pmatrix} \\
 & \xrightarrow{R_2 \leftrightarrow R_4} \begin{pmatrix} 0 & -2 & 3 & 1 \\ 0 & 0 & -1 & -6 \\ 1 & 2 & -3 & 2 \\ 0 & 0 & 3 & 4 \end{pmatrix} \xrightarrow{R_4 \rightarrow R_4 + 3R_2} \begin{pmatrix} 0 & -2 & 3 & 1 \\ 0 & 0 & -1 & -6 \\ 1 & 2 & -3 & 2 \\ 0 & 0 & 0 & -14 \end{pmatrix} \xrightarrow{R_3 \leftrightarrow R_1} \begin{pmatrix} 1 & 2 & -3 & 2 \\ 0 & 0 & -1 & -6 \\ 0 & -2 & 3 & 1 \\ 0 & 0 & 0 & -14 \end{pmatrix} \\
 & \xrightarrow{R_2 \leftrightarrow R_3} \begin{pmatrix} 1 & 2 & -3 & 2 \\ 0 & -2 & 3 & 1 \\ 0 & 0 & -1 & -6 \\ 0 & 0 & 0 & -14 \end{pmatrix}. \text{ Then } P = \begin{pmatrix} 0 & 0 & 1 & 0 \\ 1 & 0 & 0 & 0 \\ 0 & 0 & 0 & 1 \\ 0 & 1 & 0 & 0 \end{pmatrix} \text{ and } PA = \begin{pmatrix} 1 & 2 & -3 & 2 \\ 0 & -2 & 3 & 1 \\ -2 & -4 & 5 & -10 \\ 0 & 4 & -3 & 2 \end{pmatrix} \\
 & \xrightarrow{R_3 \rightarrow R_3 + 2R_1} \begin{pmatrix} 1 & 2 & -3 & 2 \\ 0 & -2 & 3 & 1 \\ 0 & 0 & -1 & -6 \\ 0 & 4 & -3 & 2 \end{pmatrix} \xrightarrow{R_4 \rightarrow R_4 + 2R_2} \begin{pmatrix} 1 & 2 & -3 & 2 \\ 0 & -2 & 3 & 1 \\ 0 & 0 & -1 & -6 \\ 0 & 0 & 3 & 4 \end{pmatrix} \xrightarrow{R_4 \rightarrow R_4 + 3R_3} \begin{pmatrix} 1 & 2 & -3 & 2 \\ 0 & -2 & 3 & 1 \\ 0 & 0 & -1 & -6 \\ 0 & 0 & 0 & -14 \end{pmatrix} =
 \end{aligned}$$

U . Thus $PA = LU$ where $L = \begin{pmatrix} 1 & 0 & 0 & 0 \\ 0 & 1 & 0 & 0 \\ -2 & 0 & 1 & 0 \\ 0 & -2 & -3 & 1 \end{pmatrix}$.

b) $LU\mathbf{x} = PA\mathbf{x} = P\mathbf{b} = \begin{pmatrix} 0 & 0 & 1 & 0 \\ 1 & 0 & 0 & 0 \\ 0 & 0 & 0 & 1 \\ 0 & 1 & 0 & 0 \end{pmatrix} \begin{pmatrix} 6 \\ 1 \\ 0 \\ 5 \end{pmatrix} = \begin{pmatrix} 0 \\ 6 \\ 5 \\ 1 \end{pmatrix}$. We seek a \mathbf{y} such that $L\mathbf{y} = \begin{pmatrix} 0 \\ 6 \\ 5 \\ 1 \end{pmatrix}$. From

$L\mathbf{y} = \begin{pmatrix} 1 & 0 & 0 & 0 \\ 0 & 1 & 0 & 0 \\ -2 & 0 & 1 & 0 \\ 0 & -2 & -3 & 1 \end{pmatrix} \begin{pmatrix} y_1 \\ y_2 \\ y_3 \\ y_4 \end{pmatrix} = \begin{pmatrix} 0 \\ 6 \\ 5 \\ 1 \end{pmatrix}$. We get $y_1 = 0$, $y_2 = 6$, $-2y_1 + y_3 = 5$, $-2y_2 - 3y_3 + y_4 = 1$.

Solving we get $y_3 = 5$, $y_4 = 28$, and $\mathbf{y} = \begin{pmatrix} 0 \\ 6 \\ 5 \\ 28 \end{pmatrix}$. Now, find an \mathbf{x} such that $U\mathbf{x} = \begin{pmatrix} 0 \\ 6 \\ 5 \\ 28 \end{pmatrix}$. That

is $\begin{pmatrix} 1 & 2 & -3 & 2 \\ 0 & -2 & 3 & 1 \\ 0 & 0 & -1 & -6 \\ 0 & 0 & 0 & -14 \end{pmatrix} \begin{pmatrix} x_1 \\ x_2 \\ x_3 \\ x_4 \end{pmatrix} = \begin{pmatrix} 0 \\ 6 \\ 5 \\ 28 \end{pmatrix}$. We get $x_1 + 2x_2 - 3x_3 + 2x_4 = 0$, $-2x_2 + 3x_3 + x_4 = 6$,

$-x_3 - 6x_4 = 5$, $-14x_4 = 28$. Backsolving we get $x_1 = 12$, $x_2 = \frac{13}{2}$, $x_3 = 7$, $x_4 = -2$. The solution is

$$\begin{pmatrix} 12 \\ 13/2 \\ 7 \\ -2 \end{pmatrix}.$$

24. Let $B = LM$. $b_{ii} = \sum_{k=1}^n l_{ik}m_{ki}$. Since L and M are lower triangular with ones on the diagonal, we have the following conditions: $l_{ik} = 0$ if $k > i$, $m_{ki} = 0$ if $i > k$, $l_{ii} = 1$, and $m_{ii} = 1$. So if $k < i$ or $k > i$ we have that $l_{ik}m_{ki} = 0$. If $k = i$ we have $l_{ii}m_{ii} = 1$. Thus $b_{ii} = \sum_{k=1}^n l_{ik}m_{ki} = 1$. Now $b_{ij} = \sum_{k=1}^n l_{ik}m_{kj}$. $m_{kj} = 0$ if $j > k$, $l_{ik} = 0$ if $k > i$. Suppose $j > i$. If $k \leq i$, then $k < j$ and hence $m_{kj} = 0$. If $k > i$ then $l_{ik} = 0$. Thus if $j > i$ then $l_{ik}m_{kj} = 0$ and hence $b_{ij} = 0$. Therefore LM is lower triangular with ones on the diagonal.

25. Suppose that L and M are upper triangular. Then if $j < i$, $l_{ij} = 0$ and $m_{ij} = 0$. Let $B = LM$, $b_{ij} = \sum_{k=1}^n l_{ik}m_{kj}$. Suppose $j < i$. If $k \leq j$, then $k < i$ and hence $l_{ik} = 0$. If $k > j$, then $m_{kj} = 0$. Thus if $j < i$, then $l_{ik}m_{kj} = 0$ and hence $b_{ij} = 0$. Therefore LM is upper triangular.

$$26. A = \begin{pmatrix} -1 & 2 & 1 \\ 2 & -4 & -2 \\ 4 & -8 & -4 \end{pmatrix} \xrightarrow{R_2 \rightarrow R_2 + 2R_1} \begin{pmatrix} -1 & 2 & 1 \\ 0 & 0 & 0 \\ 4 & -8 & -4 \end{pmatrix} \xrightarrow{R_3 \rightarrow R_3 + 4R_1} \begin{pmatrix} -1 & 2 & 1 \\ 0 & 0 & 0 \\ 0 & 0 & 0 \end{pmatrix} = U. \text{ Thus } A = LU$$

where $L = \begin{pmatrix} 1 & 0 & 0 \\ -2 & 1 & 0 \\ -4 & 0 & 1 \end{pmatrix}$. Also $\begin{pmatrix} 1 & 0 & 0 \\ -2 & 1 & 0 \\ -4 & x & 1 \end{pmatrix} \begin{pmatrix} -1 & 2 & 1 \\ 0 & 0 & 0 \\ 0 & 0 & 0 \end{pmatrix} = \begin{pmatrix} -1 & 2 & 1 \\ 2 & -4 & -2 \\ 4 & -8 & -4 \end{pmatrix}$ for any real number x . So the LU -factorization of the matrix is not unique.

$$27. A = \begin{pmatrix} 3 & -3 & 2 & 5 \\ 2 & 1 & -6 & 0 \\ 5 & -2 & -4 & 5 \\ 1 & -4 & 8 & 5 \end{pmatrix} = \begin{pmatrix} 1 & 0 & 0 & 0 \\ a & 1 & 0 & 0 \\ b & c & 1 & 0 \\ d & e & f & 1 \end{pmatrix} \begin{pmatrix} 3 & -3 & 2 & 5 \\ 0 & u & v & w \\ 0 & 0 & x & y \\ 0 & 0 & 0 & z \end{pmatrix}. \text{ This yields the equations } 3a = 2, -3a + u = 1,$$

$2a + v = -6, 5a + w = 0, 3b = 5, -3b + cu = -2, 2b + cv + x = -4, 5b + cw + y = 5, 3d = 1, -3d + eu = -4, 2d + ev + fx = 8, 5d + ew + fy + z = 5$. Solving we get $a = \frac{2}{3}, b = \frac{5}{3}, c = 1, d = \frac{1}{3}, e = -1, f = \text{any real number}, u = 3, v = -\frac{22}{3}, w = -\frac{10}{3}, x = 0, y = 0, z = 0$. Thus $A = LU$ where

$$L = \begin{pmatrix} 1 & 0 & 0 & 0 \\ \frac{2}{3} & 1 & 0 & 0 \\ \frac{5}{3} & 1 & 1 & 0 \\ \frac{1}{3} & -1 & f & 1 \end{pmatrix}, \text{ where } f \text{ can be any real number, and } U = \begin{pmatrix} 3 & -3 & 2 & 5 \\ 0 & 3 & -\frac{22}{3} & -\frac{10}{3} \\ 0 & 0 & 0 & 0 \\ 0 & 0 & 0 & 0 \end{pmatrix}. \text{ Since there is more}$$

than one possibility for f , the LU factorization of A is not unique.

$$28. A = \begin{pmatrix} 1 & 2 \\ 2 & 4 \end{pmatrix} \xrightarrow{R_2 \rightarrow R_2 - 2R_1} \begin{pmatrix} 1 & 2 \\ 0 & 0 \end{pmatrix} = U. \text{ Thus } A = LU \text{ where } L = \begin{pmatrix} 1 & 0 \\ 2 & 1 \end{pmatrix}.$$

$$29. A = \begin{pmatrix} -1 & 2 & 3 \\ 2 & 1 & 7 \\ 1 & 3 & 10 \end{pmatrix} \xrightarrow{R_2 \rightarrow R_2 + 2R_1} \begin{pmatrix} -1 & 2 & 3 \\ 0 & 5 & 13 \\ 1 & 3 & 10 \end{pmatrix} \xrightarrow{R_3 \rightarrow R_3 + R_1} \begin{pmatrix} -1 & 2 & 3 \\ 0 & 5 & 13 \\ 0 & 5 & 13 \end{pmatrix} \\ \xrightarrow{R_3 \rightarrow R_3 - R_2} \begin{pmatrix} -1 & 2 & 3 \\ 0 & 5 & 13 \\ 0 & 0 & 0 \end{pmatrix} = U. \text{ Thus } A = LU \text{ where } L = \begin{pmatrix} 1 & 0 & 0 \\ -2 & 1 & 0 \\ -1 & 1 & 1 \end{pmatrix}.$$

$$\begin{aligned}
30. A &= \begin{pmatrix} -1 & 1 & 4 & 6 \\ 2 & -1 & 0 & 2 \\ 0 & 3 & 1 & 5 \\ 1 & 3 & 5 & 13 \end{pmatrix} \xrightarrow{R_2 \rightarrow R_2 + 2R_1} \begin{pmatrix} -1 & 1 & 4 & 6 \\ 0 & 1 & 8 & 14 \\ 0 & 3 & 1 & 5 \\ 1 & 3 & 5 & 13 \end{pmatrix} \xrightarrow{R_4 \rightarrow R_4 + R_1} \begin{pmatrix} -1 & 1 & 4 & 6 \\ 0 & 1 & 8 & 14 \\ 0 & 3 & 1 & 5 \\ 0 & 4 & 9 & 19 \end{pmatrix} \\
&\xrightarrow{R_3 \rightarrow R_3 - 3R_2} \begin{pmatrix} -1 & 1 & 4 & 6 \\ 0 & 1 & 8 & 14 \\ 0 & 0 & -23 & -37 \\ 0 & 4 & 9 & 19 \end{pmatrix} \xrightarrow{R_4 \rightarrow R_4 - 4R_2} \begin{pmatrix} -1 & 1 & 4 & 6 \\ 0 & 1 & 8 & 14 \\ 0 & 0 & -23 & -37 \\ 0 & 0 & -23 & -37 \end{pmatrix} \xrightarrow{R_4 \rightarrow R_4 - R_3} \\
&\begin{pmatrix} -1 & 1 & 4 & 6 \\ 0 & 1 & 8 & 14 \\ 0 & 0 & -23 & -37 \\ 0 & 0 & 0 & 0 \end{pmatrix} = U. \text{ Thus } A = LU \text{ where } L = \begin{pmatrix} 1 & 0 & 0 & 0 \\ -2 & 1 & 0 & 0 \\ 0 & 3 & 1 & 0 \\ -1 & 4 & 1 & 1 \end{pmatrix}.
\end{aligned}$$

$$\begin{aligned}
31. A &= \begin{pmatrix} 2 & -1 & 1 & 7 \\ 3 & 2 & 1 & 6 \\ 1 & 3 & 0 & -1 \\ 4 & 5 & 1 & 5 \end{pmatrix} \xrightarrow{R_2 \rightarrow R_2 - \frac{3}{2}R_1} \begin{pmatrix} 2 & -1 & 1 & 7 \\ 0 & \frac{7}{2} & -\frac{1}{2} & -\frac{9}{2} \\ 1 & 3 & 0 & -1 \\ 4 & 5 & 1 & 5 \end{pmatrix} \xrightarrow{R_3 \rightarrow R_3 - \frac{1}{2}R_1} \begin{pmatrix} 2 & -1 & 1 & 7 \\ 0 & \frac{7}{2} & -\frac{1}{2} & -\frac{9}{2} \\ 0 & \frac{7}{2} & -\frac{1}{2} & -\frac{9}{2} \\ 4 & 5 & 1 & 5 \end{pmatrix} \\
&\xrightarrow{R_4 \rightarrow R_4 - 2R_1} \begin{pmatrix} 2 & -1 & 1 & 7 \\ 0 & \frac{7}{2} & -\frac{1}{2} & -\frac{9}{2} \\ 0 & \frac{7}{2} & -\frac{1}{2} & -\frac{9}{2} \\ 0 & 7 & -1 & -9 \end{pmatrix} \xrightarrow{R_4 \rightarrow R_4 - 2R_2} \begin{pmatrix} 2 & -1 & 1 & 7 \\ 0 & \frac{7}{2} & -\frac{1}{2} & -\frac{9}{2} \\ 0 & 0 & 0 & 0 \\ 0 & 0 & 0 & 0 \end{pmatrix} = U. \text{ Thus } A = LU \text{ where } L = \\
&\begin{pmatrix} 1 & 0 & 0 & 0 \\ \frac{3}{2} & 1 & 0 & 0 \\ \frac{1}{2} & 1 & 1 & 0 \\ 2 & 2 & 0 & 1 \end{pmatrix}.
\end{aligned}$$

$$\begin{aligned}
32. A &= \begin{pmatrix} 2 & -1 & 0 & 2 \\ 4 & -2 & 0 & 4 \\ -2 & 1 & 0 & -2 \\ 6 & -3 & 0 & 6 \end{pmatrix} \xrightarrow{R_2 \rightarrow R_2 - 2R_1} \begin{pmatrix} 2 & -1 & 0 & 2 \\ 0 & 0 & 0 & 0 \\ -2 & 1 & 0 & -2 \\ 6 & -3 & 0 & 6 \end{pmatrix} \xrightarrow{R_3 \rightarrow R_3 + R_1} \begin{pmatrix} 2 & -1 & 0 & 2 \\ 0 & 0 & 0 & 0 \\ 0 & 0 & 0 & 0 \\ 6 & -3 & 0 & 6 \end{pmatrix} \\
&\xrightarrow{R_4 \rightarrow R_4 - 3R_1} \begin{pmatrix} 2 & -1 & 0 & 2 \\ 0 & 0 & 0 & 0 \\ 0 & 0 & 0 & 0 \\ 0 & 0 & 0 & 0 \end{pmatrix} = U. \text{ Thus } A = LU \text{ where } L = \begin{pmatrix} 1 & 0 & 0 & 0 \\ 2 & 1 & 0 & 0 \\ -1 & 0 & 1 & 0 \\ 3 & 0 & 0 & 1 \end{pmatrix}.
\end{aligned}$$

33. $A = \begin{pmatrix} 1 & 2 & 3 \\ -1 & 2 & 4 \end{pmatrix} = \begin{pmatrix} 1 & 0 \\ a & 1 \end{pmatrix} \begin{pmatrix} 1 & 2 & 3 \\ 0 & u & v \end{pmatrix}$. This yields the equations $a = -1$, $2a + u = 2$, $3a + v = 4$. Solving we get $u = 4$, $v = 7$. Thus $A = LU$ where $L = \begin{pmatrix} 1 & 0 \\ -1 & 1 \end{pmatrix}$ and $u = \begin{pmatrix} 1 & 2 & 3 \\ 0 & 4 & 7 \end{pmatrix}$.

34. $A = \begin{pmatrix} 2 & 1 \\ -1 & 4 \\ 6 & 0 \end{pmatrix} = \begin{pmatrix} 1 & 0 & 0 \\ a & 1 & 0 \\ b & c & 1 \end{pmatrix} \begin{pmatrix} 2 & 1 \\ 0 & u \\ 0 & 0 \end{pmatrix}$. This yields the equations $2a = -1$, $a + u = 4$, $2b = 6$, $b + cu = 0$.

Solving we get $a = -\frac{1}{2}$, $b = 3$, $c = \frac{-2}{3}$, $u = \frac{9}{2}$. Thus $A = LU$ where $L = \begin{pmatrix} 1 & 0 & 0 \\ -\frac{1}{2} & 1 & 0 \\ 3 & -\frac{2}{3} & 1 \end{pmatrix}$ and

$$U = \begin{pmatrix} 2 & 1 \\ 0 & \frac{9}{2} \\ 0 & 0 \end{pmatrix}.$$

35. $A = \begin{pmatrix} 7 & 1 & 3 & 4 \\ -2 & 5 & 6 & 8 \end{pmatrix} = \begin{pmatrix} 1 & 0 \\ a & 1 \end{pmatrix} \begin{pmatrix} 7 & 1 & 3 & 4 \\ 0 & u & v & w \end{pmatrix}$. This yields the equations $7a = -2$, $a + u = 5$, $3a + v = 6$, $4a + w = 8$. Solving we get $a = \frac{-2}{7}$, $u = \frac{37}{7}$, $v = \frac{48}{7}$, $w = \frac{64}{7}$. Thus $A = LU$ where $L = \begin{pmatrix} 1 & 0 \\ -\frac{2}{7} & 1 \end{pmatrix}$ and $U = \begin{pmatrix} 7 & 1 & 3 & 4 \\ 0 & 37/7 & 48/7 & 64/7 \end{pmatrix}$.

36. $A = \begin{pmatrix} 4 & -1 & 2 & 1 \\ 2 & 1 & 6 & 5 \\ 3 & 2 & -1 & 7 \end{pmatrix} = \begin{pmatrix} 1 & 0 & 0 \\ a & 1 & 0 \\ b & c & 1 \end{pmatrix} \begin{pmatrix} 4 & -1 & 2 & 1 \\ 0 & u & v & w \\ 0 & 0 & x & y \end{pmatrix}$. This yields the equations $4a = 2$, $-a + u = 1$, $2a + v = 6$, $a + w = 5$, $4b = 3$, $-b + cu = 2$, $2b + cv + x = -1$, $b + cw + y = 7$. Solving we get $a = \frac{1}{2}$, $b = \frac{3}{4}$, $c = \frac{11}{6}$, $u = \frac{3}{2}$, $v = 5$, $w = \frac{9}{2}$, $x = \frac{35}{3}$, $y = -2$. Thus $A = LU$ where $L = \begin{pmatrix} 1 & 0 & 0 \\ \frac{1}{2} & 1 & 0 \\ \frac{3}{4} & \frac{11}{6} & 1 \end{pmatrix}$ and $U = \begin{pmatrix} 4 & -1 & 2 & 1 \\ 0 & 3/2 & 5 & 9/2 \\ 0 & 0 & 35/3 & -2 \end{pmatrix}$.

37. $\begin{pmatrix} 5 & 1 & 3 \\ -2 & 4 & 2 \\ 1 & 6 & 1 \\ -2 & 2 & 0 \\ 5 & -3 & 1 \end{pmatrix} = \begin{pmatrix} 1 & 0 & 0 & 0 & 0 \\ a & 1 & 0 & 0 & 0 \\ b & c & 1 & 0 & 0 \\ d & e & f & 1 & 0 \\ g & h & i & j & 1 \end{pmatrix} \begin{pmatrix} 5 & 1 & 3 \\ 0 & u & v \\ 0 & 0 & w \\ 0 & 0 & 0 \\ 0 & 0 & 0 \end{pmatrix}$. This yields the equations $5a = -2$, $a + u = 4$, $3a + v = 2$, $5b = 1$, $b + cu = 6$, $3b + cv + w = 1$, $5d = -2$, $d + eu = 2$, $3d + ev + fw = 0$, $5g = 5$, $g + hu = -3$, $3g + hv + iw + j \cdot 0 = 1$. Solving we get $a = \frac{-2}{5}$, $b = \frac{1}{5}$, $c = \frac{29}{22}$, $d = \frac{-2}{5}$, $e = \frac{6}{11}$, $f = \frac{1}{7}$, $g = 1$, $h = \frac{-10}{11}$, $i = \frac{-5}{21}$, $j =$ any real number, $u = \frac{22}{5}$, $v = \frac{16}{5}$, $w = \frac{-42}{11}$. Thus $A = LU$ where $L = \begin{pmatrix} 1 & 0 & 0 & 0 \\ -2/5 & 1 & 0 & 0 \\ 1/5 & 29/22 & 1 & 0 \\ -2/5 & 6/11 & 1/7 & 1 \\ 1 & -10/11 & -5/21 & j \end{pmatrix}$, j any real number, and $U = \begin{pmatrix} 5 & 1 & 3 \\ 0 & 22/5 & 16/5 \\ 0 & 0 & -42/11 \\ 0 & 0 & 0 \\ 0 & 0 & 0 \end{pmatrix}$.

38. $A = \begin{pmatrix} -1 & 2 & 1 \\ 1 & 6 & 5 \\ -2 & 3 & 7 \\ 1 & 0 & 2 \\ 4 & 1 & 5 \end{pmatrix} = \begin{pmatrix} 1 & 0 & 0 & 0 & 0 \\ a & 1 & 0 & 0 & 0 \\ b & c & 1 & 0 & 0 \\ d & e & f & 1 & 0 \\ g & h & i & j & 1 \end{pmatrix} \begin{pmatrix} -1 & 2 & 1 \\ 0 & u & v \\ 0 & 0 & w \\ 0 & 0 & 0 \\ 0 & 0 & 0 \end{pmatrix}$. This yields the equations $-a = 1$, $2a + u = 6$, $a + v = 5$, $-b = -2$, $2b + cu = 3$, $b + cv + w = 7$, $-d = 1$, $2d + eu = 0$, $d + ev + fw = 2$, $-g = 4$, $2g + hu = 1$, $g + hv + iw + j = 5$. Solving we get $a = -1$, $b = 2$, $c = \frac{-1}{8}$, $d = -1$, $e = \frac{1}{4}$, $f = \frac{6}{23}$, $g = -4$, $h = \frac{9}{8}$, $i = \frac{9}{23}$, $j =$

any real number, $u = 8, v = 6, w = \frac{23}{4}$. Thus $A = LU$ where $L = \begin{pmatrix} 1 & 0 & 0 & 0 \\ -1 & 1 & 0 & 0 \\ 2 & -1/8 & 1 & 0 \\ -1 & 1/4 & 6/23 & 1 \\ -4 & 9/8 & 9/23 & j \end{pmatrix}$, j any real

number, and $U = \begin{pmatrix} -1 & 2 & 1 \\ 0 & 8 & 6 \\ 0 & 0 & 23/4 \\ 0 & 0 & 0 \\ 0 & 0 & 0 \end{pmatrix}$.

CALCULATOR SOLUTIONS 1.11

Problems 39-44 ask for a $PA = LU$ factorization. This is computed on the TI-85 by the LU function, which is invoked with four arguments in the form $LU(A, L, U, P)$, where A is the input argument - the name of the variable containing the matrix to be factored, and L, U, P are output arguments, telling the function names for the variables in which to store the respective parts of the factorization. You can invoke this function by entering the alphabetic characters shown, including the three commas or you can use the **MATRIX MATH (MORE) LU** menu entry, and then entering the "A, L, U, P" entries. As usual we will assume the input matrices are entered in variables $A111nn$, $nn = 39, \dots, 44$. The LU factorization computed on the TI-85 is actually the "Crout" LU-factorization which gives an upper triangular U with ones on the diagonal, as if we had found an echelon form of PA by forward elimination without row interchanges.

39. After entering $LU(A11139, L11139, U11139, P11139)$ **(ENTER)**, we find that

$$L11139 \text{ (ENTER) yields } \begin{bmatrix} 3 & 0 & & 0 \\ 0 & 2 & & 0 \\ 2 & -1.666666666667 & & 8.5 \end{bmatrix},$$

$$U11139 \text{ (ENTER) yields } \begin{bmatrix} 1 & .333333333333 & 2.33333333333 & \\ 0 & 1 & 2.5 & \\ 0 & 0 & 1 & \end{bmatrix},$$

$$\text{and for the permutation matrix } P11139 \text{ (ENTER) is } \begin{bmatrix} 0 & 1 & 0 \\ 1 & 0 & 0 \\ 0 & 0 & 1 \end{bmatrix}.$$

40. After $LU(A11140, L11140, U11140, P11140)$ **(ENTER)**, we find that

$$L11140 \text{ (ENTER) yields } \begin{bmatrix} 16 & 0 & 0 & 0 \\ 4 & 10.75 & 0 & 0 \\ 13 & -2.0625 & 14.9534883721 & 0 \\ 2 & -1.625 & 8.72093023256 & 8.29237947123 \end{bmatrix},$$

$$U11140 \text{ (ENTER) yields } \begin{bmatrix} 1 & .3125 & -.5 & .25 \\ 0 & 1 & 1.67441860465 & -.837209302326 \\ 0 & 0 & 1 & -.132192846034 \\ 0 & 0 & 0 & 1 \end{bmatrix},$$

$$\text{and for the permutation matrix } P11140 \text{ (ENTER) gives } \begin{bmatrix} 0 & 0 & 0 & 1 \\ 0 & 1 & 0 & 0 \\ 0 & 0 & 1 & 0 \\ 1 & 0 & 0 & 0 \end{bmatrix}.$$

41. After $LU(A11141, L11141, U11141, P11141)$ **(ENTER)**, we find that

$$L11141 \text{ (ENTER) yields } \begin{bmatrix} 16 & 0 & 0 & 0 \\ 0 & -7 & 0 & 0 \\ 5 & 4.5625 & 8.16964285714 & 0 \\ 2 & -.375 & -1.58928571429 & 2.97595628415 \end{bmatrix},$$

U11141 yields

$$\begin{bmatrix} 1 & -.3125 & .6875 & & .5 & & \\ 0 & 1 & & -.571428571429 & & -.142857142857 & \\ 0 & 0 & 1 & & & .018579234973 & \\ 0 & 0 & 0 & & 1 & & \end{bmatrix},$$

and for the permutation matrix P11141 gives

$$\begin{bmatrix} 0 & 0 & 0 & 1 \\ 1 & 0 & 0 & 0 \\ 0 & 1 & 0 & 0 \\ 0 & 0 & 1 & 0 \end{bmatrix}.$$

42. After LU(A11142, L11142, U11142, P11142) , we find that L11142 yields

$$\begin{bmatrix} 71 & 0 & 0 & 0 & 0 & \\ 35 & 69.676056338 & 0 & 0 & 0 & \\ 14 & 38.0704225352 & 79.5154639175 & 0 & 0 & \\ 14 & 14.0704225352 & 19.5967252881 & -33.4575239664 & 0 & \\ 23 & 24.9014084507 & 24.2302405498 & -31.3474653183 & 14.7770382416 & \end{bmatrix}$$

U11142 yields

$$\begin{bmatrix} 1 & -.647887323944 & .830985915493 & .915492957746 & -.30985915493 & \\ 0 & 1 & -1.57994744289 & -.129775621589 & -.561956741459 & \\ 0 & 0 & 1 & .227926876702 & 1.48061713989 & \\ 0 & 0 & 0 & 1 & .112687668795 & \\ 0 & 0 & 0 & 0 & 1 & \end{bmatrix},$$

and for the permutation matrix P11142 gives

$$\begin{bmatrix} 0 & 0 & 1 & 0 & 0 \\ 0 & 0 & 0 & 1 & 0 \\ 0 & 0 & 0 & 0 & 1 \\ 0 & 1 & 0 & 0 & 0 \\ 1 & 0 & 0 & 0 & 0 \end{bmatrix}.$$

43. After LU(A11143, L11143, U11143, P11143) , we find that

L11143 yields

$$\begin{bmatrix} .91 & 0 & 0 & 0 & \\ .83 & .50021978022 & 0 & 0 & \\ .46 & -.036263736264 & .189244288225 & 0 & \\ .21 & .266923076923 & .063804920914 & .049489575595 & \end{bmatrix},$$

U11143 yields

$$\begin{bmatrix} 1 & .252747252747 & .175824175824 & -.21978021978 & \\ 0 & 1 & -1.65114235501 & 1.90399824253 & \\ 0 & 0 & 1 & -2.21858748143 & \\ 0 & 0 & 0 & 1 & \end{bmatrix},$$

and for the permutation matrix P11143 gives

$$\begin{bmatrix} 0 & 1 & 0 & 0 \\ 0 & 0 & 0 & 1 \\ 0 & 0 & 1 & 0 \\ 1 & 0 & 0 & 0 \end{bmatrix}.$$

44. After LU(A11142, L11142, U11142, P11142) , we find that

L111144 **ENTER** yields $\begin{bmatrix} 1 & 0 & 0 & 0 & 0 \\ 0 & 5 & 0 & 0 & 0 \\ 1 & 0 & 3 & 0 & 0 \\ 0 & 0 & 0 & 5 & 0 \\ 0 & 0 & 2 & 3 & -1.6 \end{bmatrix}$,

U111144 **ENTER** yields $\begin{bmatrix} 1 & 2 & 0 & 0 & 0 \\ 0 & 1 & 1.2 & .2 & 0 \\ 0 & 0 & 1 & 0 & 0 \\ 0 & 0 & 0 & 1 & 1.2 \\ 0 & 0 & 0 & 0 & 1 \end{bmatrix}$,

and for the permutation matrix P111144 **ENTER** gives $\begin{bmatrix} 1 & 0 & 0 & 0 & 0 \\ 0 & 0 & 1 & 0 & 0 \\ 0 & 1 & 0 & 0 & 0 \\ 0 & 0 & 0 & 0 & 1 \\ 0 & 0 & 0 & 1 & 0 \end{bmatrix}$.

MATLAB 1.11

1. We eliminate down each column, and accumulate the product of the inverses of the elementary matrices.

```

>> A = [8 2 -4 6; 10 1 -8 9; 4 7 10 3];
>> U = A;
>> c = -U(2,1)/U(1,1);           % Eliminate U(2,1).
>> F = eye(3); F(2,1) = c;
>> U = F*U;
>> L = inv(F)
L =
    1.0000         0         0
    1.2500    1.0000         0
         0         0    1.0000

>> c = -U(3,1)/U(1,1);           % Eliminate U(3,1).
>> F = eye(3); F(3,1) = c;
>> U = F*U
U =
    8.0000    2.0000   -4.0000    6.0000
         0   -1.5000   -3.0000    1.5000
         0    6.0000   12.0000         0

>> L = L*inv(F)
L =
    1.0000         0         0
    1.2500    1.0000         0
    0.5000         0    1.0000

>> c = -U(3,2)/U(2,2);           % Eliminate U(3,2).
>> F = eye(3); F(3,2) = c;
>> U = F*U                       % Notice that U is in echelon form.
U =
    8.0000    2.0000   -4.0000    6.0000
         0   -1.5000   -3.0000    1.5000
         0         0         0    6.0000

>> L = L*inv(F)                   % Notice that L is lower triangular.
L =
    1.0000         0         0
    1.2500    1.0000         0
    0.5000   -4.0000    1.0000

>> L*U
ans =
     8     2    -4     6
    10     1    -8     9
     4     7    10     3

```

2.

```

>> A = rand(5);           % A random 5x5 matrix.
>> b = rand(5,1);        % A random 5 vector.
>> flops(0); rref([A b]); frref=flops
frref =                   % This number will be slightly higher in MATLAB 3.5
    1986   % It may also vary slightly for different random A

>> flops(0), x = A\b, flu=flops
x =
    -0.9377
     0.7523
     0.8705
    -0.0748
     0.1154
flu =
    271

```

- (b) The previous code can be repeated several more times for part (b).
- (c) The number of operations was fewer for the second version. However, very similar operation counts should apply for the `A\b` and `rref` methods. The great discrepancy here results from the fact that `rref` incurs an enormous overhead when it attempts to produce nice (rational) results if appropriate. You can enter the MATLAB command `type rref` to see the code, which always includes at least one call to `rat(A)`. If you compute `flops(0); [num,den]=rat(A); all(all(A==num./den)); flops` to determine the number of flops involved in deciding rationality, you will find that, say for a 5×6 , there are about only 210 flops of the 1900 reported above which actually arise from `rref`. Thus `rref([A b])` and `A\b` do, in fact, take almost the same number of operations. Even without the calls to 'rat', the computed counts indicate a bit of overhead. If you did `rref` by hand, you'd do less than 200 multiplications, divisions and additions. (In fact less than 125 if you avoid unnecessary operations, see Appendix 3, page A-27 and the solution to A3.3). Similar counts would apply to LU-factorization followed by forward and back elimination on the right hand side, even when partial pivoting is done.

3. (a)

```

>> A = 2*rand(3)-1
A =
    0.4834    0.0500    0.4268
   -0.9618   -0.0734   -0.0221
    0.7721   -0.8696    0.3354

>> [L, U, P] = lu(A)
L =
    1.0000         0         0
   -0.8027    1.0000         0
   -0.5026   -0.0141    1.0000
U =
   -0.9618   -0.0734   -0.0221
         0   -0.9285    0.3176
         0         0    0.4202
P =
     0     1     0
     0     0     1
     1     0     0

```

```

>> L*U                                % This should be the same as P*A below.
ans =
   -0.9618   -0.0734   -0.0221
    0.7721   -0.8696    0.3354
    0.4834    0.0500    0.4268

>> P*A                                % This should be the same as L*U above.
ans =
   -0.9618   -0.0734   -0.0221
    0.7721   -0.8696    0.3354
    0.4834    0.0500    0.4268

```

(b)

```

>> A = round(10*(2*rand(4)-1))
A =
     4     8    10     0
    -6     1     -6     8
     8    -7     -1    -1
     7    -1     -4    -1

>> [L, U, P] = lu(A)
L =
   1.0000     0     0     0
   0.5000    1.0000     0     0
   0.8750    0.4457    1.0000     0
  -0.7500   -0.3696    0.3677    1.0000

U =
   8.0000   -7.0000   -1.0000   -1.0000
     0    11.5000    10.5000    0.5000
     0     0    -7.8043   -0.3478
     0     0     0     7.5627

P =
     0     0     1     0
     1     0     0     0
     0     0     0     1
     0     1     0     0

>> C = P*A
C =
     8    -7    -1    -1
     4     8    10     0
     7    -1    -4    -1
    -6     1    -6     8

>> c = -C(2,1)/C(1,1); F = eye(4); F(2,1) = c; % Eliminate C(2,1).
>> C = F*C;
>> L2 = inv(F)                                % L2 should end up the same as L.
L2 =
   1.0000     0     0     0
   0.5000    1.0000     0     0
     0     0    1.0000     0
     0     0     0     1.0000

>> c = -C(3,1)/C(1,1); F = eye(4); F(3,1) = c; % Eliminate C(3,1).
>> C = F*C;

```

```

>> L2 = L2*inv(F); % Accumulate product of inv(F)'s.
>> c = -C(4,1)/C(1,1); F = eye(4); F(4,1) = c; % Eliminate C(4,1), end col. 1.
>> C = F*C
C =
    8.0000   -7.0000   -1.0000   -1.0000
         0   11.5000   10.5000    0.5000
         0    5.1250   -3.1250   -0.1250
         0   -4.2500   -6.7500    7.2500

>> L2 = L2*inv(F) % Note column 1 of L and L2 agree.
L2 =
    1.0000         0         0         0
    0.5000    1.0000         0         0
    0.8750         0    1.0000         0
   -0.7500         0         0    1.0000

>> c = -C(3,2)/C(2,2); F = eye(4); % Eliminate C(3,2), start col. 2
>> F(3,2) = c; % Note C(2,2) is largest in column 2.
>> C = F*C;

>> L2 = L2*inv(F);

>> c = -C(4,2)/C(2,2); F = eye(4); F(4,2) = c; % Eliminate C(4,2).
>> C = F*C % This finishes column 2.
C =
    8.0000   -7.0000   -1.0000   -1.0000
         0   11.5000   10.5000    0.5000
         0         0   -7.8043   -0.3478
         0         0   -2.8696    7.4348

>> L2 = L2*inv(F) % Now column 2 of L2 and L agree.
L2 =
    1.0000         0         0         0
    0.5000    1.0000         0         0
    0.8750    0.4457    1.0000         0
   -0.7500   -0.3696         0    1.0000

>> c = -C(4,3)/C(3,3); F = eye(4); F(4,3) = c; % Eliminate C(4,3).
>> C = F*C % Note c(3,3) is largest.
C =
    8.0000   -7.0000   -1.0000   -1.0000
         0   11.5000   10.5000    0.5000
         0         0   -7.8043   -0.3478
         0         0         0    7.5627

>> L2 = L2*inv(F)
L2 =
    1.0000         0         0         0
    0.5000    1.0000         0         0
    0.8750    0.4457    1.0000         0
   -0.7500   -0.3696    0.3677    1.0000

```

Notice that C reduces to U and that $L2$ is the same as L , as predicted. At each step we can check that the pivot was the largest number (in absolute value) when compared to those below it in the same column.

4.

```

>> A = rand(3)                % A random matrix.
A =
    0.7734    0.4177    0.2053
    0.7273    0.6825    0.8364
    0.3192    0.6806    0.7089

>> [ L, U, P ] = lu(A)
L =
    1.0000         0         0
    0.4127    1.0000         0
    0.9405    0.5700    1.0000
U =
    0.7734    0.4177    0.2053
         0    0.5082    0.6242
         0         0    0.2876
P =
     1     0     0
     0     0     1
     0     1     0

>> B = P*A                    % Store P*A in B, and work with B.
B =
    0.7734    0.4177    0.2053
    0.3192    0.6806    0.7089
    0.7273    0.6825    0.8364

>> B(2,:) = B(2,:) - L(2,1)*B(1,:) % Eliminate B(2,1) using
B =                                % L(2,1) as the multiplier.
    0.7734    0.4177    0.2053
         0    0.5082    0.6242
    0.7273    0.6825    0.8364

>> B(3,:) = B(3,:) - L(3,1)*B(1,:) % Eliminate B(3,1).
B =
    0.7734    0.4177    0.2053
         0    0.5082    0.6242
    0.0000    0.2896    0.6434

>> B(3,:) = B(3,:) - L(3,2)*B(2,:) % Eliminate B(3,2).
B =
    0.7734    0.4177    0.2053
         0    0.5082    0.6242
    0.0000    0.0000    0.2876

```

Notice that B was reduced to U , as expected.

Section 1.12

1. $\begin{pmatrix} 0 & 1 & 1 & 0 \\ 0 & 0 & 0 & 0 \\ 1 & 1 & 0 & 0 \\ 1 & 0 & 0 & 0 \end{pmatrix}$

2. $\begin{pmatrix} 0 & 1 & 1 & 0 & 0 \\ 0 & 0 & 0 & 1 & 0 \\ 1 & 1 & 0 & 1 & 0 \\ 0 & 0 & 1 & 0 & 1 \\ 1 & 0 & 1 & 0 & 0 \end{pmatrix}$

3. $\begin{pmatrix} 0 & 0 & 1 & 0 & 0 \\ 1 & 0 & 0 & 1 & 0 \\ 0 & 1 & 0 & 1 & 0 \\ 1 & 1 & 1 & 0 & 1 \\ 0 & 1 & 0 & 0 & 0 \end{pmatrix}$

4. $\begin{pmatrix} 0 & 0 & 1 & 2 & 0 & 0 \\ 1 & 0 & 0 & 1 & 0 & 0 \\ 0 & 0 & 0 & 1 & 0 & 1 \\ 1 & 1 & 0 & 0 & 1 & 0 \\ 0 & 0 & 0 & 1 & 0 & 0 \\ 1 & 0 & 1 & 0 & 1 & 0 \end{pmatrix}$

5. $\begin{matrix} 1 \leftrightarrow 2 \\ \downarrow \nearrow \uparrow \\ 4 \leftrightarrow 3 \end{matrix}$

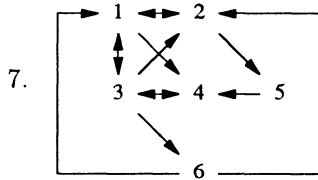
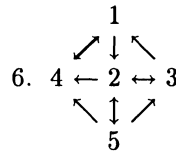

8. $A^2 = \begin{pmatrix} 1 & 1 & 0 & 2 & 0 \\ 0 & 0 & 1 & 0 & 1 \\ 0 & 1 & 2 & 1 & 1 \\ 2 & 1 & 1 & 1 & 0 \\ 1 & 2 & 1 & 1 & 0 \end{pmatrix}$. Thus there are 21 2-chains.

$A^3 = \begin{pmatrix} 0 & 1 & 3 & 1 & 2 \\ 2 & 1 & 1 & 1 & 0 \\ 3 & 2 & 2 & 3 & 1 \\ 1 & 3 & 3 & 2 & 1 \\ 1 & 2 & 2 & 3 & 1 \end{pmatrix}$. Thus there are 42 3-chains.

$A^4 = \begin{pmatrix} 5 & 3 & 3 & 4 & 1 \\ 1 & 3 & 3 & 2 & 1 \\ 3 & 5 & 7 & 4 & 3 \\ 4 & 4 & 4 & 6 & 2 \\ 3 & 3 & 5 & 4 & 3 \end{pmatrix}$. Thus there are 86 4-chains.

9. $A^2 = \begin{pmatrix} 0 & 1 & 0 & 1 & 0 \\ 1 & 1 & 2 & 0 & 1 \\ 2 & 1 & 1 & 1 & 1 \\ 1 & 2 & 1 & 2 & 0 \\ 1 & 0 & 0 & 1 & 0 \end{pmatrix}$. Thus there are 21 2-chains.

$A^3 = \begin{pmatrix} 2 & 1 & 1 & 1 & 1 \\ 1 & 3 & 1 & 3 & 0 \\ 2 & 3 & 3 & 2 & 1 \\ 4 & 3 & 3 & 3 & 2 \\ 1 & 1 & 2 & 0 & 1 \end{pmatrix}$. Thus there are 45 3-chains.

$$A^4 = \begin{pmatrix} 2 & 3 & 3 & 2 & 1 \\ 6 & 4 & 4 & 4 & 3 \\ 5 & 6 & 4 & 6 & 2 \\ 6 & 8 & 7 & 6 & 3 \\ 1 & 3 & 1 & 3 & 0 \end{pmatrix}. \text{ Thus there are 93 4-chains.}$$

10. Given a redundant path from vertex A to vertex B , it is possible to construct a shorter path from A to B by not passing through any vertex more than once. Thus, the shortest path linking two vertices is not redundant.
11. Since A represents the total number of 1-step links between vertices and A^2 represents the total number of 2-step links between vertices, then $A + A^2$ represents the number of 1-step or 2-step links between vertices.
12. Direct dominance: P_1 over P_2 ; P_3 over P_1, P_5, P_6 ; P_5 over P_4 ; and P_6 over P_2, P_4 .
Indirect dominance: P_3 over P_2, P_4 .

Review Exercises for Chapter 1

$$1. \left(\begin{array}{cc|c} 3 & 6 & 9 \\ -2 & 3 & 4 \end{array} \right) \rightarrow \left(\begin{array}{cc|c} 1 & 2 & 3 \\ 0 & 7 & 10 \end{array} \right) \rightarrow \left(\begin{array}{cc|c} 1 & 9 & 1/7 \\ 0 & 1 & 10/7 \end{array} \right). \text{ Solution: } (1/7, 10/7)$$

$$2. \left(\begin{array}{cc|c} 3 & 6 & 9 \\ 2 & 4 & 6 \end{array} \right) \rightarrow \left(\begin{array}{cc|c} 1 & 2 & 3 \\ 0 & 0 & 0 \end{array} \right). \text{ Solution: } (3 - 2x_2, x_2)$$

$$3. \left(\begin{array}{cc|c} 3 & -6 & 9 \\ -2 & 4 & 6 \end{array} \right) \rightarrow \left(\begin{array}{cc|c} 1 & -2 & 3 \\ 0 & 0 & 12 \end{array} \right). \text{ No solution.}$$

$$4. \left(\begin{array}{ccc|c} 1 & 1 & 1 & 2 \\ 2 & -1 & 2 & 4 \\ -3 & 2 & 3 & 8 \end{array} \right) \rightarrow \left(\begin{array}{ccc|c} 1 & 1 & 1 & 2 \\ 0 & -3 & 0 & 0 \\ 0 & 5 & 6 & 14 \end{array} \right) \rightarrow \left(\begin{array}{ccc|c} 1 & 0 & 1 & 2 \\ 0 & 1 & 0 & 0 \\ 0 & 0 & 6 & 14 \end{array} \right) \rightarrow \left(\begin{array}{ccc|c} 1 & 0 & 0 & -1/3 \\ 0 & 1 & 0 & 0 \\ 0 & 0 & 1 & 7/3 \end{array} \right).$$

Solution: $(-1/3, 0, 7/3)$

$$5. \left(\begin{array}{ccc|c} 1 & 1 & 1 & 0 \\ 2 & -1 & 2 & 0 \\ -3 & 2 & 3 & 0 \end{array} \right) \rightarrow \left(\begin{array}{ccc|c} 1 & 1 & 1 & 0 \\ 0 & -3 & 0 & 0 \\ 0 & 5 & 6 & 0 \end{array} \right) \rightarrow \left(\begin{array}{ccc|c} 1 & 0 & 1 & 0 \\ 0 & 1 & 0 & 0 \\ 0 & 0 & 6 & 0 \end{array} \right) \rightarrow \left(\begin{array}{ccc|c} 1 & 0 & 0 & 0 \\ 0 & 1 & 0 & 0 \\ 0 & 0 & 1 & 0 \end{array} \right).$$

Solution: $(0, 0, 0)$

$$6. \left(\begin{array}{ccc|c} 1 & 1 & 1 & 2 \\ 2 & -1 & 2 & 4 \\ -1 & 4 & 1 & 2 \end{array} \right) \rightarrow \left(\begin{array}{ccc|c} 1 & 1 & 1 & 2 \\ 0 & -3 & 0 & 0 \\ 0 & 5 & 2 & 4 \end{array} \right) \rightarrow \left(\begin{array}{ccc|c} 1 & 0 & 1 & 2 \\ 0 & 1 & 0 & 0 \\ 0 & 0 & 2 & 4 \end{array} \right) \rightarrow \left(\begin{array}{ccc|c} 1 & 0 & 0 & 0 \\ 0 & 1 & 0 & 0 \\ 0 & 0 & 1 & 2 \end{array} \right).$$

Solution: $(0, 0, 2)$

$$7. \left(\begin{array}{ccc|c} 1 & 1 & 1 & 2 \\ 2 & -1 & 2 & 4 \\ -1 & 4 & 1 & 3 \end{array} \right) \rightarrow \left(\begin{array}{ccc|c} 1 & 1 & 1 & 2 \\ 0 & -3 & 0 & 0 \\ 0 & 5 & 2 & 5 \end{array} \right) \rightarrow \left(\begin{array}{ccc|c} 1 & 0 & 1 & 2 \\ 0 & 1 & 0 & 0 \\ 0 & 0 & 2 & 5 \end{array} \right) \rightarrow \left(\begin{array}{ccc|c} 1 & 0 & 0 & -1/2 \\ 0 & 1 & 0 & 0 \\ 0 & 0 & 1 & 5/2 \end{array} \right)$$

Solution: $(-1/2, 0, 5/2)$

$$8. \left(\begin{array}{ccc|c} 1 & 1 & 1 & 0 \\ 2 & -1 & 2 & 0 \\ -1 & 4 & 1 & 0 \end{array} \right) \rightarrow \left(\begin{array}{ccc|c} 1 & 1 & 1 & 0 \\ 0 & -3 & 0 & 0 \\ 0 & 5 & 2 & 0 \end{array} \right) \rightarrow \left(\begin{array}{ccc|c} 1 & 0 & 1 & 0 \\ 0 & 1 & 0 & 0 \\ 0 & 0 & 2 & 0 \end{array} \right) \rightarrow \left(\begin{array}{ccc|c} 1 & 0 & 0 & 0 \\ 0 & 1 & 0 & 0 \\ 0 & 0 & 1 & 0 \end{array} \right)$$

Solution: $(0, 0, 0)$

$$9. \left(\begin{array}{ccc|c} 2 & 1 & -3 & 0 \\ 4 & -1 & 1 & 0 \end{array} \right) \rightarrow \left(\begin{array}{ccc|c} 1 & 1/2 & -3/2 & 0 \\ 0 & -3 & 7 & 0 \end{array} \right) \rightarrow \left(\begin{array}{ccc|c} 1 & 0 & -1/3 & 0 \\ 0 & 1 & -7/3 & 0 \end{array} \right)$$

Solution: $(x_3/3, 7x_3/3, x_3)$

$$10. \left(\begin{array}{cc|c} 1 & 1 & 0 \\ 2 & 1 & 0 \\ 3 & 1 & 0 \end{array} \right) \rightarrow \left(\begin{array}{cc|c} 1 & 1 & 0 \\ 0 & -1 & 0 \\ 0 & -2 & 0 \end{array} \right) \rightarrow \left(\begin{array}{cc|c} 1 & 0 & 0 \\ 0 & 1 & 0 \\ 0 & 0 & 0 \end{array} \right). \text{ Solution: } (0, 0)$$

$$11. \begin{pmatrix} 1 & 1 & | & 1 \\ 2 & 1 & | & 3 \\ 3 & 1 & | & 4 \end{pmatrix} \rightarrow \begin{pmatrix} 1 & 1 & | & 1 \\ 0 & -1 & | & 1 \\ 0 & -2 & | & 1 \end{pmatrix} \rightarrow \begin{pmatrix} 1 & 0 & | & 2 \\ 0 & 1 & | & -1 \\ 0 & 0 & | & -1 \end{pmatrix}. \text{ No solution.}$$

$$12. \begin{pmatrix} 1 & 1 & 1 & 1 & | & 4 \\ 2 & -3 & -1 & 4 & | & 7 \\ -2 & 4 & 1 & -2 & | & 1 \\ 5 & -1 & 2 & 1 & | & -1 \end{pmatrix} \rightarrow \begin{pmatrix} 1 & 1 & 1 & 1 & | & 4 \\ 0 & 1 & 0 & 2 & | & 8 \\ 0 & 6 & 3 & 0 & | & 9 \\ 0 & -6 & -3 & -4 & | & -21 \end{pmatrix} \rightarrow \begin{pmatrix} 1 & 0 & 1 & -1 & | & -4 \\ 0 & 1 & 0 & 2 & | & 8 \\ 0 & 0 & 3 & -12 & | & -39 \\ 0 & 0 & 0 & -4 & | & -12 \end{pmatrix}$$

$$\rightarrow \begin{pmatrix} 1 & 0 & 0 & 3 & | & 9 \\ 0 & 1 & 0 & 2 & | & 8 \\ 0 & 0 & 1 & -4 & | & -13 \\ 0 & 0 & 0 & 1 & | & 3 \end{pmatrix} \rightarrow \begin{pmatrix} 1 & 0 & 0 & 0 & | & 0 \\ 0 & 1 & 0 & 0 & | & 2 \\ 0 & 0 & 1 & 0 & | & -1 \\ 0 & 0 & 0 & 1 & | & 3 \end{pmatrix}. \text{ Solution: } (0, 2, -1, 3)$$

$$13. \begin{pmatrix} 1 & 1 & 1 & 1 & | & 0 \\ 2 & -3 & -1 & 4 & | & 0 \\ -2 & 4 & 1 & -2 & | & 0 \\ 5 & -1 & 2 & 1 & | & 0 \end{pmatrix} \rightarrow \begin{pmatrix} 1 & 1 & 1 & 1 & | & 0 \\ 0 & 1 & 0 & 2 & | & 0 \\ 0 & 6 & 3 & 0 & | & 0 \\ 0 & -6 & -3 & -4 & | & 0 \end{pmatrix} \rightarrow \begin{pmatrix} 1 & 0 & 1 & -1 & | & 0 \\ 0 & 1 & 0 & 2 & | & 0 \\ 0 & 0 & 3 & -12 & | & 0 \\ 0 & 0 & 0 & -4 & | & 0 \end{pmatrix}$$

$$\rightarrow \begin{pmatrix} 1 & 0 & 0 & 3 & | & 0 \\ 0 & 1 & 0 & 2 & | & 0 \\ 0 & 0 & 1 & -4 & | & 0 \\ 0 & 0 & 0 & 1 & | & 0 \end{pmatrix} \rightarrow \begin{pmatrix} 1 & 0 & 0 & 0 & | & 0 \\ 0 & 1 & 0 & 0 & | & 0 \\ 0 & 0 & 1 & 0 & | & 0 \\ 0 & 0 & 0 & 1 & | & 0 \end{pmatrix}. \text{ Solution: } (0, 0, 0, 0)$$

$$14. \begin{pmatrix} 1 & 1 & 1 & 1 & | & 0 \\ 2 & -3 & -1 & 4 & | & 0 \\ -2 & 4 & 1 & -2 & | & 0 \end{pmatrix} \rightarrow \begin{pmatrix} 1 & 1 & 1 & 1 & | & 0 \\ 0 & 1 & 0 & 2 & | & 0 \\ 0 & 6 & 3 & 0 & | & 0 \end{pmatrix} \rightarrow \begin{pmatrix} 1 & 0 & 1 & -1 & | & 0 \\ 0 & 1 & 0 & 2 & | & 0 \\ 0 & 0 & 3 & -6 & | & 0 \end{pmatrix}$$

$$\rightarrow \begin{pmatrix} 1 & 0 & 0 & 3 & | & 0 \\ 0 & 1 & 0 & 2 & | & 0 \\ 0 & 0 & 1 & -4 & | & 0 \end{pmatrix}. \text{ Solution: } (-3x_4, -2x_4, 4x_4, x_4)$$

$$15. 3 \begin{pmatrix} -2 & 1 \\ 0 & 4 \\ 2 & 3 \end{pmatrix} = \begin{pmatrix} -6 & 3 \\ 0 & 12 \\ 6 & 9 \end{pmatrix}$$

$$16. \begin{pmatrix} 1 & 0 & 3 \\ 2 & -1 & 6 \end{pmatrix} + \begin{pmatrix} 2 & 0 & 4 \\ -2 & 5 & 8 \end{pmatrix} = \begin{pmatrix} 3 & 0 & 7 \\ 0 & 4 & 14 \end{pmatrix}$$

$$17. 5 \begin{pmatrix} 2 & 1 & 3 \\ -1 & 2 & 4 \\ -6 & 1 & 5 \end{pmatrix} - 3 \begin{pmatrix} -2 & 1 & 4 \\ 5 & 0 & 7 \\ 2 & -1 & 3 \end{pmatrix} = \begin{pmatrix} 10 & 5 & 15 \\ -5 & 10 & 20 \\ -30 & 5 & 25 \end{pmatrix} - \begin{pmatrix} -6 & 3 & 12 \\ 15 & 0 & 21 \\ 6 & -3 & 9 \end{pmatrix}$$

$$= \begin{pmatrix} 16 & 2 & 3 \\ -20 & 10 & -1 \\ -36 & 8 & 16 \end{pmatrix}$$

$$18. \begin{pmatrix} 2 & 3 \\ -1 & 4 \end{pmatrix} \begin{pmatrix} 5 & -1 \\ 2 & 7 \end{pmatrix} = \begin{pmatrix} 16 & 19 \\ 3 & 29 \end{pmatrix}$$

$$19. \begin{pmatrix} 2 & 3 & 1 & 5 \\ 0 & 6 & 2 & 4 \end{pmatrix} \begin{pmatrix} 5 & 7 & 1 \\ 2 & 0 & 3 \\ 1 & 0 & 0 \\ 0 & 5 & 6 \end{pmatrix} = \begin{pmatrix} 17 & 39 & 41 \\ 14 & 20 & 42 \end{pmatrix}$$

$$20. \begin{pmatrix} 2 & 3 & 5 \\ -1 & 6 & 4 \\ 1 & 0 & 6 \end{pmatrix} \begin{pmatrix} 0 & -1 & 2 \\ 3 & 1 & 2 \\ -7 & 3 & 5 \end{pmatrix} = \begin{pmatrix} -26 & 16 & 35 \\ -18 & 19 & 30 \\ -42 & 17 & 32 \end{pmatrix}$$

$$21. \begin{pmatrix} 1 & 0 & 3 & -1 & 5 \\ 2 & 1 & 6 & 2 & 5 \end{pmatrix} \begin{pmatrix} 7 & 1 \\ 2 & 3 \\ -1 & 0 \\ 5 & 6 \\ 2 & 3 \end{pmatrix} = \begin{pmatrix} 9 & 10 \\ 30 & 32 \end{pmatrix}$$

$$22. \begin{pmatrix} 1 & -1 & 2 \\ 3 & 5 & 6 \\ 2 & 4 & -1 \end{pmatrix} \begin{pmatrix} 2 \\ 1 \\ 3 \end{pmatrix} = \begin{pmatrix} 7 \\ 29 \\ 5 \end{pmatrix}$$

23. Reduced row echelon form.

24. Row echelon form.

25. Neither.

26. Reduced row echelon form.

$$27. \begin{pmatrix} 2 & 8 & -2 \\ 1 & 0 & -6 \end{pmatrix} \rightarrow \begin{pmatrix} 1 & 4 & -1 \\ 0 & 4 & 5 \end{pmatrix} \rightarrow \begin{pmatrix} 1 & 4 & -1 \\ 0 & 1 & 5/4 \end{pmatrix} \text{ (Row echelon form)}$$

$$\rightarrow \begin{pmatrix} 1 & 0 & -6 \\ 0 & 1 & 5/4 \end{pmatrix} \text{ (Reduced row echelon form)}$$

$$28. \begin{pmatrix} 1 & -1 & 2 & 4 \\ -1 & 2 & 0 & 3 \\ 2 & 3 & -1 & 1 \end{pmatrix} \rightarrow \begin{pmatrix} 1 & -1 & 2 & 4 \\ 0 & 1 & 2 & 7 \\ 0 & 5 & -5 & -7 \end{pmatrix} \rightarrow \begin{pmatrix} 1 & -1 & 2 & 4 \\ 0 & 1 & 2 & 7 \\ 0 & 0 & -15 & -42 \end{pmatrix}$$

$$\rightarrow \begin{pmatrix} 1 & -1 & 2 & 4 \\ 0 & 1 & 2 & 7 \\ 0 & 0 & 1 & 14/5 \end{pmatrix} \text{ (Row echelon form)}$$

$$\rightarrow \begin{pmatrix} 1 & 0 & 4 & 11 \\ 0 & 1 & 2 & 7 \\ 0 & 0 & 1 & 14/5 \end{pmatrix} \rightarrow \begin{pmatrix} 1 & 0 & 0 & -1/5 \\ 0 & 1 & 0 & 7/5 \\ 0 & 0 & 1 & 14/5 \end{pmatrix} \text{ (Reduced row echelon form)}$$

$$29. \begin{pmatrix} 2 & 3 \\ -1 & 4 \end{pmatrix} \rightarrow \begin{pmatrix} 1 & 3/2 \\ 0 & 11/2 \end{pmatrix} \rightarrow \begin{pmatrix} 1 & 3/2 \\ 0 & 1 \end{pmatrix}$$

$$\det \begin{pmatrix} 2 & 3 \\ -1 & 4 \end{pmatrix} = 8 + 3 = 11; \text{ Inverse: } \frac{1}{11} \begin{pmatrix} 4 & -3 \\ 1 & 2 \end{pmatrix}$$

$$30. \begin{pmatrix} -1 & 2 \\ 2 & -4 \end{pmatrix} \rightarrow \begin{pmatrix} 1 & -2 \\ 0 & 0 \end{pmatrix} \text{ Not invertible.}$$

$$31. \begin{pmatrix} 1 & 2 & 0 \\ 2 & 1 & -1 \\ 3 & 1 & 1 \end{pmatrix} \rightarrow \begin{pmatrix} 1 & 2 & 0 \\ 0 & -3 & -1 \\ 0 & -5 & 1 \end{pmatrix} \rightarrow \begin{pmatrix} 1 & 2 & 0 \\ 0 & 1 & 1/3 \\ 0 & 0 & 8/3 \end{pmatrix} \rightarrow \begin{pmatrix} 1 & 2 & 0 \\ 0 & 1 & 1/3 \\ 0 & 0 & 1 \end{pmatrix}$$

$$\left(\begin{array}{ccc|ccc} 1 & 2 & 0 & 1 & 0 & 0 \\ 2 & 1 & -1 & 0 & 1 & 0 \\ 3 & 1 & 1 & 0 & 0 & 1 \end{array} \right) \rightarrow \left(\begin{array}{ccc|ccc} 1 & 2 & 0 & 1 & 0 & 0 \\ 0 & -3 & -1 & -2 & 1 & 0 \\ 0 & -5 & 1 & -3 & 0 & 1 \end{array} \right) \rightarrow \left(\begin{array}{ccc|ccc} 1 & 0 & -2/3 & -1/3 & 2/3 & 0 \\ 0 & 1 & 1/3 & 2/3 & -1/3 & 0 \\ 0 & 0 & 8/3 & 1/3 & -5/3 & 1 \end{array} \right)$$

$$\rightarrow \left(\begin{array}{ccc|ccc} 1 & 0 & 0 & -1/4 & 1/4 & 1/4 \\ 0 & 1 & 0 & 5/8 & -1/8 & -1/8 \\ 0 & 0 & 1 & 1/8 & -5/8 & 3/8 \end{array} \right); \text{ Inverse: } \frac{1}{8} \begin{pmatrix} -2 & 2 & 2 \\ 5 & -1 & -1 \\ 1 & -5 & 3 \end{pmatrix}$$

$$32. \begin{pmatrix} -1 & 2 & 0 \\ 4 & 1 & -3 \\ 2 & 4 & -3 \end{pmatrix} \rightarrow \begin{pmatrix} 1 & -2 & 0 \\ 0 & 9 & -3 \\ 0 & 9 & -3 \end{pmatrix} \rightarrow \begin{pmatrix} 1 & -2 & 0 \\ 0 & 1 & -1/3 \\ 0 & 0 & 0 \end{pmatrix}; \text{ Not invertible}$$

$$33. \begin{pmatrix} 2 & 0 & 4 \\ -1 & 3 & 1 \\ 0 & 1 & 2 \end{pmatrix} \rightarrow \begin{pmatrix} 1 & 0 & 2 \\ 0 & 3 & 3 \\ 0 & 1 & 2 \end{pmatrix} \rightarrow \begin{pmatrix} 1 & 0 & 2 \\ 0 & 1 & 1 \\ 0 & 0 & 1 \end{pmatrix}$$

$$\left(\begin{array}{ccc|ccc} 2 & 0 & 4 & 1 & 0 & 0 \\ -1 & 3 & 1 & 0 & 1 & 0 \\ 0 & 1 & 2 & 0 & 0 & 1 \end{array} \right) \rightarrow \left(\begin{array}{ccc|ccc} 1 & 0 & 2 & 1/2 & 0 & 0 \\ 0 & 3 & 3 & 1/2 & 1 & 0 \\ 0 & 1 & 2 & 0 & 0 & 1 \end{array} \right) \rightarrow \left(\begin{array}{ccc|ccc} 1 & 0 & 2 & 1/2 & 0 & 0 \\ 0 & 1 & 1 & 1/6 & 1/3 & 0 \\ 0 & 0 & 1 & -1/6 & -1/3 & 1 \end{array} \right)$$

$$\rightarrow \left(\begin{array}{ccc|ccc} 1 & 0 & 0 & 5/6 & 2/3 & -2 \\ 0 & 1 & 0 & 1/3 & 2/3 & -1 \\ 0 & 0 & 1 & -1/6 & -1/3 & 1 \end{array} \right); \text{ Inverse: } \frac{1}{6} \begin{pmatrix} 5 & 4 & -12 \\ 2 & 4 & -6 \\ -1 & -2 & 6 \end{pmatrix}$$

$$34. \begin{pmatrix} 1 & -3 \\ 2 & 5 \end{pmatrix} \begin{pmatrix} x_1 \\ x_2 \end{pmatrix} = \begin{pmatrix} 4 \\ 7 \end{pmatrix}; \det A = 5 + 6 = 11; A^{-1} = \frac{1}{11} \begin{pmatrix} 5 & 3 \\ -2 & 1 \end{pmatrix}$$

$$\begin{pmatrix} x_1 \\ x_2 \end{pmatrix} = \frac{1}{11} \begin{pmatrix} 5 & 3 \\ -2 & 1 \end{pmatrix} \begin{pmatrix} 4 \\ 7 \end{pmatrix} = \begin{pmatrix} 41/11 \\ -1/11 \end{pmatrix}$$

$$35. \begin{pmatrix} 1 & 2 & 0 \\ 2 & 1 & -1 \\ 3 & 1 & 1 \end{pmatrix} \begin{pmatrix} x_1 \\ x_2 \\ x_3 \end{pmatrix} = \begin{pmatrix} 3 \\ -1 \\ 7 \end{pmatrix}; \text{ From problem 31, } A^{-1} = \frac{1}{8} \begin{pmatrix} -2 & 2 & 2 \\ 5 & -1 & -1 \\ 1 & -5 & 3 \end{pmatrix}$$

$$\begin{pmatrix} x_1 \\ x_2 \\ x_3 \end{pmatrix} = \frac{1}{8} \begin{pmatrix} -2 & 2 & 2 \\ 5 & -1 & -1 \\ 1 & -5 & 3 \end{pmatrix} \begin{pmatrix} 3 \\ -1 \\ 7 \end{pmatrix} = \begin{pmatrix} 3/4 \\ 9/8 \\ 29/8 \end{pmatrix}$$

$$36. \begin{pmatrix} 2 & 0 & 4 \\ -1 & 3 & 1 \\ 0 & 1 & 2 \end{pmatrix} \begin{pmatrix} x_1 \\ x_2 \\ x_3 \end{pmatrix} = \begin{pmatrix} 7 \\ -4 \\ 5 \end{pmatrix}; \text{ From problem 33, } A^{-1} = \frac{1}{6} \begin{pmatrix} 5 & 4 & -12 \\ 2 & 4 & -6 \\ -1 & -2 & 6 \end{pmatrix}$$

$$\begin{pmatrix} x_1 \\ x_2 \\ x_3 \end{pmatrix} = \frac{1}{6} \begin{pmatrix} 5 & 4 & -12 \\ 2 & 4 & -6 \\ -1 & -2 & 6 \end{pmatrix} \begin{pmatrix} 7 \\ -4 \\ 5 \end{pmatrix} = \begin{pmatrix} -41/6 \\ -16/3 \\ 31/6 \end{pmatrix}$$

$$37. A^t = \begin{pmatrix} 2 & -1 \\ 3 & 0 \\ 1 & 2 \end{pmatrix}; A \text{ is not symmetric or skew-symmetric.}$$

$$38. A^t = \begin{pmatrix} 4 & 6 \\ 6 & 4 \end{pmatrix}; A \text{ is symmetric.}$$

$$39. A^t = \begin{pmatrix} 2 & 3 & 1 \\ 3 & -6 & -5 \\ 1 & -5 & 9 \end{pmatrix}; A \text{ is symmetric.}$$

$$40. A^t = \begin{pmatrix} 0 & -5 & -6 \\ 5 & 0 & -4 \\ 6 & 4 & 0 \end{pmatrix}; A \text{ is skew-symmetric.}$$

$$41. A^t = \begin{pmatrix} 1 & -1 & 4 & 6 \\ -1 & 2 & 5 & 7 \\ 4 & 5 & 3 & -8 \\ 6 & 7 & -8 & 9 \end{pmatrix}; A \text{ is symmetric.}$$

$$42. A^t = \begin{pmatrix} 0 & -1 & 1 & 1 \\ 1 & 0 & 1 & -2 \\ -1 & 1 & 0 & -1 \\ 1 & -2 & 1 & 0 \end{pmatrix}; A \text{ is not symmetric or skew-symmetric.}$$

$$43. \begin{pmatrix} 1 & 0 & 0 \\ 0 & -2 & 0 \\ 0 & 0 & 1 \end{pmatrix}$$

$$44. \begin{pmatrix} 1 & 2 & 0 \\ 0 & 1 & 0 \\ 0 & 0 & 1 \end{pmatrix}$$

$$45. \begin{pmatrix} 1 & 0 & 0 \\ 0 & 1 & 0 \\ -5 & 0 & 1 \end{pmatrix}$$

$$46. \begin{pmatrix} 0 & 0 & 1 \\ 0 & 1 & 0 \\ 1 & 0 & 0 \end{pmatrix}$$

$$47. \begin{pmatrix} 1 & 0 & 0 \\ 0 & 1 & 1/5 \\ 0 & 0 & 1 \end{pmatrix}$$

$$48. \begin{pmatrix} 1 & -3 \\ 0 & 1 \end{pmatrix}$$

$$49. \begin{pmatrix} 0 & 1 & 0 \\ 1 & 0 & 0 \\ 0 & 0 & 1 \end{pmatrix}$$

$$50. \begin{pmatrix} 1 & 0 & 0 \\ 0 & 1 & 0 \\ 0 & 0 & -3 \end{pmatrix}$$

51. The elementary row operations to reduce the matrix to the identity are:

1. $R_1 \rightarrow R_1/2$ 2. $R_2 \rightarrow R_1 + R_2$ 3. $R_2 \rightarrow 2R_2$ 4. $R_1 \rightarrow R_1 + R_2/2$

$$\text{Then } \begin{pmatrix} 2 & -1 \\ -1 & 1 \end{pmatrix} = \begin{pmatrix} 2 & 0 \\ 0 & 1 \end{pmatrix} \begin{pmatrix} 1 & 0 \\ -1 & 1 \end{pmatrix} \begin{pmatrix} 1 & 0 \\ 0 & 1/2 \end{pmatrix} \begin{pmatrix} 1 & -1/2 \\ 0 & 1 \end{pmatrix}$$

52. The elementary row operations are: 1. $R_2 \rightarrow R_2 - 2R_1$ 2. $R_3 \rightarrow R_3 - 3R_1$
 3. $R_3 \rightarrow R_3 - 2R_2$ 4. $R_3 \rightarrow R_3/17$ 5. $R_2 \rightarrow R_2 + 11R_3$ 6. $R_1 \rightarrow R_1 - 3R_3$

Then

$$\begin{pmatrix} 1 & 0 & 3 \\ 2 & 1 & -5 \\ 3 & 2 & 4 \end{pmatrix} = \begin{pmatrix} 1 & 0 & 0 \\ 2 & 1 & 0 \\ 0 & 0 & 1 \end{pmatrix} \begin{pmatrix} 1 & 0 & 0 \\ 0 & 1 & 0 \\ 3 & 0 & 1 \end{pmatrix} \begin{pmatrix} 1 & 0 & 0 \\ 0 & 1 & 0 \\ 0 & 2 & 1 \end{pmatrix} \begin{pmatrix} 1 & 0 & 0 \\ 0 & 1 & 0 \\ 0 & 0 & 17 \end{pmatrix} \begin{pmatrix} 1 & 0 & 0 \\ 0 & 1 & -11 \\ 0 & 0 & 1 \end{pmatrix} \\
\times \begin{pmatrix} 1 & 0 & 3 \\ 0 & 1 & 0 \\ 0 & 0 & 1 \end{pmatrix}$$

53. The elementary row operations are: 1. $R_1 \rightarrow R_1/2$ 2. $R_2 \rightarrow R_2 + 4R_1$

$$\text{Then } \begin{pmatrix} 2 & -1 \\ -4 & 2 \end{pmatrix} = \begin{pmatrix} 2 & 0 \\ 0 & 1 \end{pmatrix} \begin{pmatrix} 1 & 0 \\ -4 & 1 \end{pmatrix} \begin{pmatrix} 1 & -1/2 \\ 0 & 0 \end{pmatrix}$$

54. The elementary row operations are: 1. $R_2 \rightarrow R_2 - 2R_1$ 2. $R_3 \rightarrow R_3 - R_1$

3. $R_3 \rightarrow R_2 - R_3$

$$\text{Then } \begin{pmatrix} 1 & -2 & 3 \\ 2 & 0 & 4 \\ 1 & 2 & 1 \end{pmatrix} = \begin{pmatrix} 1 & 0 & 0 \\ 2 & 1 & 0 \\ 0 & 0 & 1 \end{pmatrix} \begin{pmatrix} 1 & 0 & 0 \\ 0 & 1 & 0 \\ 1 & 0 & 1 \end{pmatrix} \begin{pmatrix} 1 & 0 & 0 \\ 0 & 1 & 0 \\ 0 & 1 & 1 \end{pmatrix} \begin{pmatrix} 1 & -2 & 3 \\ 0 & 4 & -2 \\ 0 & 0 & 0 \end{pmatrix}$$

$$55. A = \begin{pmatrix} 1 & -2 & 5 \\ 2 & -5 & 7 \\ 4 & -3 & 8 \end{pmatrix} \xrightarrow{R_2 \rightarrow R_2 - 2R_1} \begin{pmatrix} 1 & -2 & 5 \\ 0 & -1 & -3 \\ 4 & -3 & 8 \end{pmatrix} \xrightarrow{R_3 \rightarrow R_3 - 4R_1} \begin{pmatrix} 1 & -2 & 5 \\ 0 & -1 & -3 \\ 0 & 5 & -12 \end{pmatrix}$$

$$\xrightarrow{R_3 \rightarrow R_3 + 5R_2} \begin{pmatrix} 1 & -2 & 5 \\ 0 & -1 & -3 \\ 0 & 0 & -27 \end{pmatrix} = U. \text{ Thus } A = LU \text{ where } L = \begin{pmatrix} 1 & 0 & 0 \\ 2 & 1 & 0 \\ 4 & -5 & 1 \end{pmatrix}. \text{ The system } Ly = \mathbf{b}, \text{ i.e.,}$$

$$\begin{pmatrix} 1 & 0 & 0 \\ 2 & 1 & 0 \\ 4 & -5 & 1 \end{pmatrix} \begin{pmatrix} y_1 \\ y_2 \\ y_3 \end{pmatrix} = \begin{pmatrix} -1 \\ 2 \\ 5 \end{pmatrix} \text{ yields the equations } y_1 = -1, 2y_1 + y_2 = 2, 4y_1 - 5y_2 + y_3 = 5. \text{ Solving}$$

$$\text{we get } y_2 = 4, y_3 = 29 \text{ and } \mathbf{y} = \begin{pmatrix} -1 \\ 4 \\ 29 \end{pmatrix}. \text{ Now, from } U\mathbf{x} = \mathbf{y}, \text{ i.e., } \begin{pmatrix} 1 & -2 & 5 \\ 0 & -1 & -3 \\ 0 & 0 & -27 \end{pmatrix} \begin{pmatrix} x_1 \\ x_2 \\ x_3 \end{pmatrix} = \begin{pmatrix} -1 \\ 4 \\ 29 \end{pmatrix} \text{ we}$$

obtain $x_1 - 2x_2 + 5x_3 = -1, -1x_2 - 3x_3 = 4, -27x_3 = 29$. Solving we get $x_1 = \frac{76}{27}, x_2 = \frac{-7}{9}, x_3 = \frac{-29}{27}$.

$$\text{The solution is } \mathbf{x} = \begin{pmatrix} 76/27 \\ -7/9 \\ -29/27 \end{pmatrix}.$$

$$56. A = \begin{pmatrix} 2 & 5 & -2 \\ 4 & 11 & 3 \\ 6 & -1 & 2 \end{pmatrix} \xrightarrow{R_2 \rightarrow R_2 - 2R_1} \begin{pmatrix} 2 & 5 & -2 \\ 0 & 1 & 7 \\ 6 & -1 & 2 \end{pmatrix} \xrightarrow{R_3 \rightarrow R_3 - 3R_1} \begin{pmatrix} 2 & 5 & -2 \\ 0 & 1 & 7 \\ 0 & -16 & 8 \end{pmatrix}$$

$$\xrightarrow{R_3 \rightarrow R_3 + 16R_2} \begin{pmatrix} 2 & 5 & -2 \\ 0 & 1 & 7 \\ 0 & 0 & 120 \end{pmatrix} = U. \text{ Thus } A = LU \text{ where } L = \begin{pmatrix} 1 & 0 & 0 \\ 2 & 1 & 0 \\ 3 & -16 & 1 \end{pmatrix}. \text{ The system } Ly = \mathbf{b}, \text{ i.e.,}$$

$$\begin{pmatrix} 1 & 0 & 0 \\ 2 & 1 & 0 \\ 3 & -16 & 1 \end{pmatrix} \begin{pmatrix} y_1 \\ y_2 \\ y_3 \end{pmatrix} = \begin{pmatrix} 3 \\ 0 \\ 7 \end{pmatrix} \text{ yields the equations } y_1 = 3, 2y_1 + y_2 = 0, 3y_1 - 16y_2 + y_3 = 7. \text{ Solving we}$$

$$\text{get } y_2 = -6, y_3 = -98 \text{ and } \mathbf{y} = \begin{pmatrix} 3 \\ -6 \\ -98 \end{pmatrix}. \text{ Now from } U\mathbf{x} = \mathbf{y}, \text{ i.e., } \begin{pmatrix} 2 & 5 & -2 \\ 0 & 1 & 7 \\ 0 & 0 & 120 \end{pmatrix} \begin{pmatrix} x_1 \\ x_2 \\ x_3 \end{pmatrix} = \begin{pmatrix} 3 \\ -6 \\ -98 \end{pmatrix} \text{ we}$$

$$\text{obtain } 2x_1 + 5x_2 - 2x_3 = 3, x_2 + 7x_3 = -6, 120x_3 = -98. \text{ Solving we get } x_1 = \frac{167}{120}, x_2 = \frac{-17}{60}, x_3 = \frac{-49}{60}.$$

$$\text{The solution is } \begin{pmatrix} 167/120 \\ -17/60 \\ -49/60 \end{pmatrix}.$$

$$57. A = \begin{pmatrix} 0 & -1 & 4 \\ 3 & 5 & 8 \\ 1 & 3 & -2 \end{pmatrix} \xrightarrow{R_1 \rightleftharpoons R_3} \begin{pmatrix} 1 & 3 & -2 \\ 3 & 5 & 8 \\ 0 & -1 & 4 \end{pmatrix} \xrightarrow{R_1 \rightleftharpoons R_2} \begin{pmatrix} 3 & 5 & 8 \\ 1 & 3 & -2 \\ 0 & -1 & 4 \end{pmatrix}$$

$$\xrightarrow{R_2 \rightarrow R_2 - \frac{1}{3}R_3} \begin{pmatrix} 3 & 5 & 8 \\ 0 & \frac{4}{3} & -\frac{14}{3} \\ 0 & -1 & 4 \end{pmatrix} \xrightarrow{R_3 \rightarrow R_3 + \frac{3}{4}R_2} \begin{pmatrix} 3 & 5 & 8 \\ 0 & \frac{4}{3} & -\frac{14}{3} \\ 0 & 0 & \frac{1}{2} \end{pmatrix}.$$

$$\text{Then } P = \begin{pmatrix} 0 & 1 & 0 \\ 0 & 0 & 1 \\ 1 & 0 & 0 \end{pmatrix}, PA = \begin{pmatrix} 3 & 5 & 8 \\ 1 & 3 & -2 \\ 0 & -1 & 4 \end{pmatrix} \text{ and } U = \begin{pmatrix} 3 & 5 & 8 \\ 0 & \frac{4}{3} & -\frac{14}{3} \\ 0 & 0 & \frac{1}{2} \end{pmatrix}.$$

$$\text{Thus } PA = LU \text{ where } L = \begin{pmatrix} 1 & 0 & 0 \\ \frac{1}{3} & 1 & 0 \\ 0 & \frac{-3}{4} & 1 \end{pmatrix}.$$

$$\text{The system } Ly = P\mathbf{b}, \text{ i.e., } \begin{pmatrix} 1 & 0 & 0 \\ \frac{1}{3} & 1 & 0 \\ 0 & \frac{-3}{4} & 1 \end{pmatrix} \begin{pmatrix} y_1 \\ y_2 \\ y_3 \end{pmatrix} = \begin{pmatrix} -2 \\ -1 \\ 3 \end{pmatrix} \text{ yields the equations } y_1 = -2, \frac{1}{3}y_1 + y_2 = -1,$$

$$\frac{-3}{4}y_2 + y_3 = 3. \text{ Solving we get } y_2 = \frac{-1}{3}, y_3 = \frac{11}{4} \text{ and } \mathbf{y} = \begin{pmatrix} -2 \\ -\frac{1}{3} \\ \frac{11}{4} \end{pmatrix}. \text{ Now, from } U\mathbf{x} = \mathbf{y}, \text{ i.e.,}$$

$$\begin{pmatrix} 3 & 5 & 8 \\ 0 & \frac{4}{3} & -\frac{14}{3} \\ 0 & 0 & \frac{1}{2} \end{pmatrix} \begin{pmatrix} x_1 \\ x_2 \\ x_3 \end{pmatrix} = \begin{pmatrix} -2 \\ -\frac{1}{3} \\ \frac{11}{4} \end{pmatrix} \text{ we obtain } 3x_1 + 5x_2 + 8x_3 = -2, \frac{4}{3}x_2 - \frac{14}{3}x_3 = -\frac{1}{3}, \frac{1}{2}x_3 = \frac{11}{4}. \text{ Solving}$$

$$\text{we get } x_1 = -47, x_2 = 19, x_3 = \frac{11}{2}. \text{ The solution is } \begin{pmatrix} -47 \\ 19 \\ \frac{11}{2} \end{pmatrix}.$$

$$58. \begin{pmatrix} 0 & 3 & 2 \\ 1 & 2 & 4 \\ 2 & 6 & -5 \end{pmatrix} \xrightarrow{R_1 \leftrightarrow R_3} \begin{pmatrix} 2 & 6 & -5 \\ 1 & 2 & 4 \\ 0 & 3 & 2 \end{pmatrix} \xrightarrow{R_2 \rightarrow R_2 - \frac{1}{2}R_1} \begin{pmatrix} 2 & 6 & -5 \\ 0 & -1 & \frac{13}{2} \\ 0 & 3 & 2 \end{pmatrix} \xrightarrow{R_3 \rightarrow R_3 + 3R_2} \begin{pmatrix} 2 & 6 & -5 \\ 0 & -1 & \frac{13}{2} \\ 0 & 0 & \frac{43}{2} \end{pmatrix}.$$

Then $P = \begin{pmatrix} 0 & 0 & 1 \\ 0 & 1 & 0 \\ 1 & 0 & 0 \end{pmatrix}$, $PA = \begin{pmatrix} 2 & 6 & -5 \\ 1 & 2 & 4 \\ 0 & 3 & 2 \end{pmatrix}$ and $U = \begin{pmatrix} 2 & 6 & -5 \\ 0 & -1 & \frac{13}{2} \\ 0 & 0 & \frac{43}{2} \end{pmatrix}$. Thus $PA = LU$ where $L = \begin{pmatrix} 1 & 0 & 0 \\ \frac{1}{2} & 1 & 0 \\ 0 & -3 & 1 \end{pmatrix}$.

The system $Ly = Pb$, i.e., $\begin{pmatrix} 1 & 0 & 0 \\ \frac{1}{2} & 1 & 0 \\ 0 & -3 & 1 \end{pmatrix} \begin{pmatrix} y_1 \\ y_2 \\ y_3 \end{pmatrix} = \begin{pmatrix} 10 \\ 8 \\ -2 \end{pmatrix}$ yields the equations $y_1 = 10$, $\frac{1}{2}y_1 + y_2 = 8$, $-3y_2 + y_3 = -2$. Solving we get $y_2 = 3$, $y_3 = 7$ and $y = \begin{pmatrix} 10 \\ 3 \\ 7 \end{pmatrix}$. Now, from $Ux = y$, i.e.,

$$\begin{pmatrix} 2 & 6 & -5 \\ 0 & -1 & \frac{13}{2} \\ 0 & 0 & \frac{43}{2} \end{pmatrix} \begin{pmatrix} x_1 \\ x_2 \\ x_3 \end{pmatrix} = \begin{pmatrix} 10 \\ 3 \\ 7 \end{pmatrix} \text{ we obtain } 2x_1 + 6x_2 - 5x_3 = 10, -x_2 + \frac{13}{2}x_3 = 3, \frac{43}{2}x_3 = 7. \text{ Solving we}$$

get $x_1 = \frac{364}{43}$, $x_2 = \frac{-38}{43}$, $x_3 = \frac{14}{43}$. The solution is $\begin{pmatrix} 364/43 \\ -38/43 \\ 14/43 \end{pmatrix}$.

$$59. A = \begin{pmatrix} 1 & -2 & 5 \\ 2 & -5 & 7 \\ 4 & -3 & 8 \end{pmatrix} \xrightarrow{R_2 \rightarrow R_2 - 2R_1} \begin{pmatrix} 1 & -2 & 5 \\ 0 & -1 & -3 \\ 4 & -3 & 8 \end{pmatrix} \xrightarrow{R_3 \rightarrow R_3 - 4R_1} \begin{pmatrix} 1 & -2 & 5 \\ 0 & -1 & -3 \\ 0 & 5 & -12 \end{pmatrix}$$

$$\xrightarrow{R_3 \rightarrow R_3 + 5R_2} \begin{pmatrix} 1 & -2 & 5 \\ 0 & -1 & -3 \\ 0 & 0 & -27 \end{pmatrix} = U. \text{ Thus } A = LU \text{ where } L = \begin{pmatrix} 1 & 0 & 0 \\ 2 & 1 & 0 \\ 4 & -5 & 1 \end{pmatrix}. \text{ The system } Ly = b, \text{ i.e.,}$$

$$\begin{pmatrix} 1 & 0 & 0 \\ 2 & 1 & 0 \\ 4 & -5 & 1 \end{pmatrix} \begin{pmatrix} y_1 \\ y_2 \\ y_3 \end{pmatrix} = \begin{pmatrix} -1 \\ 2 \\ 5 \end{pmatrix} \text{ yields the equations } y_1 = -1, 2y_1 + y_2 = 2, 4y_1 - 5y_2 + y_3 = 5. \text{ Solving}$$

we get $y_2 = 4$, $y_3 = 29$ and $y = \begin{pmatrix} -1 \\ 4 \\ 29 \end{pmatrix}$. Now, from $Ux = y$, i.e., $\begin{pmatrix} 1 & -2 & 5 \\ 0 & -1 & -3 \\ 0 & 0 & -27 \end{pmatrix} \begin{pmatrix} x_1 \\ x_2 \\ x_3 \end{pmatrix} = \begin{pmatrix} -1 \\ 4 \\ 29 \end{pmatrix}$ we

obtain $x_1 - 2x_2 + 5x_3 = -1$, $-x_2 - 3x_3 = 4$, $-27x_3 = 29$. Solving we get $x_1 = \frac{76}{27}$, $x_2 = \frac{-7}{9}$, $x_3 = \frac{-29}{27}$.

The solution is $x = \begin{pmatrix} 76/27 \\ -7/9 \\ -29/27 \end{pmatrix}$.

$$60. A = \begin{pmatrix} 2 & 5 & -2 \\ 4 & 11 & 3 \\ 6 & -1 & 2 \end{pmatrix} \xrightarrow{R_2 \rightarrow R_2 - 2R_1} \begin{pmatrix} 2 & 5 & -2 \\ 0 & 1 & 7 \\ 6 & -1 & 2 \end{pmatrix} \xrightarrow{R_3 \rightarrow R_3 - 3R_1} \begin{pmatrix} 2 & 5 & -2 \\ 0 & 1 & 7 \\ 0 & -16 & 8 \end{pmatrix}$$

$$\xrightarrow{R_3 \rightarrow R_3 + 16R_2} \begin{pmatrix} 2 & 5 & -2 \\ 0 & 1 & 7 \\ 0 & 0 & 120 \end{pmatrix} = U. \text{ Thus } A = LU \text{ where } L = \begin{pmatrix} 1 & 0 & 0 \\ 2 & 1 & 0 \\ 3 & -16 & 1 \end{pmatrix}. \text{ The system } Ly = b, \text{ i.e.,}$$

$$\begin{pmatrix} 1 & 0 & 0 \\ 2 & 1 & 0 \\ 3 & -16 & 1 \end{pmatrix} \begin{pmatrix} y_1 \\ y_2 \\ y_3 \end{pmatrix} = \begin{pmatrix} 3 \\ 0 \\ 7 \end{pmatrix} \text{ yields the equations } y_1 = 3, 2y_1 + y_2 = 0, 3y_1 - 16y_2 + y_3 = 7. \text{ Solving we}$$

get $y_2 = -6, y_3 = -98$ and $\mathbf{y} = \begin{pmatrix} 3 \\ -6 \\ -98 \end{pmatrix}$. Now from $U\mathbf{x} = \mathbf{y}$, i.e., $\begin{pmatrix} 2 & 5 & -2 \\ 0 & 1 & 7 \\ 0 & 0 & 120 \end{pmatrix} \begin{pmatrix} x_1 \\ x_2 \\ x_3 \end{pmatrix} = \begin{pmatrix} 3 \\ -6 \\ -98 \end{pmatrix}$ we

obtain $2x_1 + 5x_2 - 2x_3 = 3, x_2 + 7x_3 = -6, 120x_3 = -98$. Solving we get $x_1 = \frac{167}{120}, x_2 = \frac{-17}{60}, x_3 = \frac{-49}{60}$.

The solution is $\begin{pmatrix} 167/120 \\ -17/60 \\ -49/60 \end{pmatrix}$.

61.

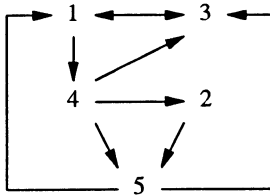

Chapter 2. Determinants

Section 2.1

$$1. \begin{vmatrix} 1 & 0 & 3 \\ 0 & 1 & 4 \\ 2 & 1 & 0 \end{vmatrix} = (1)(1)(0) + (0)(4)(2) + (3)(0)(1) - (3)(1)(2) - (1)(4)(1) - (0)(0)(0)$$

$$= -6 - 4 = -10$$

$$2. \begin{vmatrix} -1 & 1 & 0 \\ 2 & 1 & 4 \\ 1 & 5 & 6 \end{vmatrix} = (-1)(1)(6) + (1)(4)(1) + (0)(2)(5) - (1)(1)(0) - (5)(4)(-1) - (6)(2)(1)$$

$$= -6 + 4 + 20 - 12 = 6$$

$$3. \begin{vmatrix} 3 & -1 & 4 \\ 6 & 3 & 5 \\ 2 & -1 & 6 \end{vmatrix} = (3)(3)(6) + (-1)(5)(2) + (4)(6)(-1) - (2)(3)(4) - (-1)(5)(3) - (6)(6)(-1)$$

$$= 54 - 10 - 24 - 24 + 15 + 36 = 47$$

$$4. \begin{vmatrix} -1 & 0 & 6 \\ 0 & 2 & 4 \\ 1 & 2 & -3 \end{vmatrix} = (-1)(2)(-3) + (0)(4)(1) + (6)(0)(2) - (1)(2)(6) - (2)(4)(-1) - (-3)(0)(0)$$

$$= 6 - 12 + 8 = 2$$

$$5. \begin{vmatrix} -2 & 3 & 1 \\ 4 & 6 & 5 \\ 0 & 2 & 1 \end{vmatrix} = (-2)(6)(1) + (3)(5)(0) + (1)(4)(2) - (0)(6)(1) - (2)(5)(-2) - (1)(4)(3)$$

$$= -12 + 8 + 20 - 12 = 4$$

$$6. \begin{vmatrix} 5 & -2 & 1 \\ 6 & 0 & 3 \\ -2 & 1 & 4 \end{vmatrix} = (5)(0)(4) + (-2)(3)(-2) + (1)(6)(1) - (-2)(0)(1) - (1)(3)(5) - (4)(6)(-2)$$

$$= 12 + 6 - 15 + 48 = 51$$

$$7. \begin{vmatrix} 2 & 0 & 3 & 1 \\ 0 & 1 & 4 & 2 \\ 0 & 0 & 1 & 5 \\ 1 & 2 & 3 & 0 \end{vmatrix} = 2 \begin{vmatrix} 1 & 4 & 2 \\ 0 & 1 & 5 \\ 2 & 3 & 0 \end{vmatrix} + 3 \begin{vmatrix} 0 & 1 & 2 \\ 0 & 0 & 5 \\ 1 & 2 & 0 \end{vmatrix} - 1 \begin{vmatrix} 0 & 1 & 4 \\ 0 & 0 & 1 \\ 1 & 2 & 3 \end{vmatrix}$$

$$= (2)(21) + (3)(5) - (1)(1) = 56.$$

$$8. \begin{vmatrix} -3 & 0 & 0 \\ -4 & 7 & 0 \\ 5 & 8 & -1 \\ 2 & 3 & 0 \end{vmatrix} = (-3)(7)(-1)(6) = 126$$

$$9. \begin{vmatrix} -2 & 0 & 0 & 7 \\ 1 & 2 & -1 & 4 \\ 3 & 0 & -1 & 5 \\ 4 & 2 & 3 & 0 \end{vmatrix} = (-2) \begin{vmatrix} 2 & -1 & 4 \\ 0 & -1 & 5 \\ 2 & 3 & 0 \end{vmatrix} - 7 \begin{vmatrix} 1 & 2 & -1 \\ 3 & 0 & -1 \\ 4 & 2 & 3 \end{vmatrix}$$

$$= (-2)(-1) \begin{vmatrix} 2 & 4 \\ 2 & 0 \end{vmatrix} + (-2)(-5) \begin{vmatrix} 2 & -1 \\ 2 & 3 \end{vmatrix} - 7(-3) \begin{vmatrix} 2 & -1 \\ 2 & 3 \end{vmatrix} - 7(1) \begin{vmatrix} 1 & 2 \\ 4 & 2 \end{vmatrix}$$

$$= -16 + 80 + 168 + 42 = 274$$

$$10. \begin{vmatrix} 2 & 3 & -1 & 4 & 5 \\ 0 & 1 & 7 & 8 & 2 \\ 0 & 0 & 4 & -1 & 2 \\ 0 & 0 & 0 & -2 & 8 \\ 0 & 0 & 0 & 0 & 6 \end{vmatrix} = (2)(1)(4)(-2)(6) = -96$$

$$11. \text{ Let } A = \begin{pmatrix} a_{11} & 0 & \cdots & 0 \\ 0 & a_{22} & \cdots & 0 \\ \vdots & \ddots & \ddots & \vdots \\ 0 & \cdots & \cdots & a_{nn} \end{pmatrix} \text{ and } B = \begin{pmatrix} b_{11} & 0 & \cdots & 0 \\ 0 & b_{22} & \cdots & 0 \\ \vdots & \ddots & \ddots & \vdots \\ 0 & \cdots & \cdots & b_{nn} \end{pmatrix}$$

$$\text{Then } AB = \begin{pmatrix} a_{11}b_{11} & 0 & \cdots & 0 \\ 0 & a_{22}b_{22} & \cdots & 0 \\ \vdots & \ddots & \ddots & \vdots \\ 0 & \cdots & \cdots & a_{nn}b_{nn} \end{pmatrix}$$

$$\det A = a_{11}a_{22} \cdots a_{nn}; \det B = b_{11}b_{22} \cdots b_{nn};$$

$$\det AB = (a_{11}b_{11})(a_{22}b_{22}) \cdots (a_{nn}b_{nn})$$

$$= (a_{11}a_{22} \cdots a_{nn})(b_{11}b_{22} \cdots b_{nn}) = \det A \cdot \det B$$

$$12. \text{ Let } A = \begin{pmatrix} a_{11} & a_{12} & \cdots & a_{1n} \\ 0 & a_{22} & \cdots & a_{2n} \\ \vdots & \ddots & \ddots & \vdots \\ 0 & \cdots & \cdots & a_{nn} \end{pmatrix} \text{ and } B = \begin{pmatrix} b_{11} & b_{12} & \cdots & b_{1n} \\ 0 & b_{22} & \cdots & b_{2n} \\ \vdots & \ddots & \ddots & \vdots \\ 0 & \cdots & \cdots & b_{nn} \end{pmatrix}$$

$$\text{Then } AB = \begin{pmatrix} a_{11}b_{11} & a_{11}b_{12} + a_{12}b_{22} & \cdots & (a_{11}b_{1n} + \cdots + a_{1n}b_{nn}) \\ 0 & a_{22}b_{22} & \cdots & 0 \\ \vdots & \ddots & \ddots & \vdots \\ 0 & \cdots & \cdots & a_{nn}b_{nn} \end{pmatrix}$$

$$\det A = a_{11}a_{22} \cdots a_{nn}; \det B = b_{11}b_{22} \cdots b_{nn};$$

$$\det AB = (a_{11}b_{11})(a_{22}b_{22}) \cdots (a_{nn}b_{nn})$$

$$= (a_{11}a_{22} \cdots a_{nn})(b_{11}b_{22} \cdots b_{nn}) = \det A \cdot \det B$$

$$13. \text{ Let } A = \begin{pmatrix} 1 & 0 \\ 0 & 1 \end{pmatrix} \text{ and } B = \begin{pmatrix} 2 & 0 \\ 0 & 3 \end{pmatrix}. \text{ Then } \det A = 1 \text{ and } \det B = 6.$$

$$A + B = \begin{pmatrix} 3 & 0 \\ 0 & 4 \end{pmatrix}; \det(A + B) = 12$$

Then $12 \neq 1 + 6$. Thus, $\det(A + B) \neq \det A + \det B$.

14. Since A is triangular, $\det A = a_{11}a_{22}\cdots a_{nn}$. Then $\det A \neq 0$ if and only if $a_{ii} \neq 0$ for $1 \leq i \leq n$. That is, $\det A \neq 0$ if and only if the diagonal components of A are nonzero.

15. Let $A = \begin{pmatrix} a_{11} & 0 & \cdots & 0 \\ a_{21} & a_{22} & \cdots & 0 \\ \vdots & \vdots & \ddots & \vdots \\ a_{n1} & \cdots & \cdots & a_{nn} \end{pmatrix}$ be lower triangular.

Calculate the determinant of A by expanding about the first row in each case.

$$\begin{aligned} \text{Then } \det A &= a_{11} \begin{vmatrix} a_{22} & 0 & \cdots & 0 \\ \vdots & \ddots & & \vdots \\ a_{n2} & \cdots & & a_{nn} \end{vmatrix} \\ &= (a_{11})(a_{22}) \begin{vmatrix} a_{33} & 0 & \cdots & 0 \\ \vdots & \ddots & & \vdots \\ a_{n3} & \cdots & & a_{nn} \end{vmatrix} \\ &\quad \vdots \\ &= a_{11}a_{22}\cdots a_{nn} \end{aligned}$$

16. Let $u_1 = \begin{pmatrix} x_1 \\ y_1 \end{pmatrix}$, $u_2 = \begin{pmatrix} x_2 \\ y_2 \end{pmatrix}$ and $A = \begin{pmatrix} a_{11} & a_{12} \\ a_{21} & a_{22} \end{pmatrix}$.

Let $v_1 = Au_1 = \begin{pmatrix} a_{11}x_1 + a_{12}y_1 \\ a_{21}x_1 + a_{22}y_1 \end{pmatrix}$ and $v_2 = Au_2 = \begin{pmatrix} a_{11}x_2 + a_{12}y_2 \\ a_{21}x_2 + a_{22}y_2 \end{pmatrix}$

$$\begin{aligned} (\text{area generated by } v_1 \text{ and } v_2) &= \left| \begin{vmatrix} a_{11}x_1 + a_{12}y_1 & a_{11}x_2 + a_{12}y_2 \\ a_{21}x_1 + a_{22}y_1 & a_{21}x_2 + a_{22}y_2 \end{vmatrix} \right| \\ &= \left| \begin{aligned} &a_{11}x_1a_{21}x_2 + a_{11}x_1a_{22}y_2 + a_{12}y_1a_{21}x_2 + a_{12}y_1a_{22}y_2 \\ &-a_{21}x_1a_{11}x_2 - a_{22}y_1a_{11}x_2 - a_{21}x_1a_{12}y_2 - a_{22}y_1a_{12}y_2 \end{aligned} \right| \\ &= |(x_1y_2 - y_1x_2)a_{11}a_{22} - (x_1y_2 - y_1x_2)a_{21}a_{12}| \\ &= |(x_1y_2 - x_2y_1)(a_{11}a_{22} - a_{12}a_{21})| \\ &= \left| \begin{vmatrix} x_1 & y_1 \\ x_2 & y_2 \end{vmatrix} \right| \cdot \left| \begin{vmatrix} a_{11} & a_{12} \\ a_{21} & a_{22} \end{vmatrix} \right| \\ &= \begin{matrix} \text{area generated} \\ \text{by } u_1 \text{ and } u_2 \end{matrix} \cdot |\det A| \end{aligned}$$

CALCULATOR SOLUTIONS 2.1

Recall that it is always important to be able to check data which has been input for a given problem. To make this possible our solutions store the input into variables whose name includes the chapter, section and problem number. Once this is done we can invoke the `det` function on that variable to compute the determinant. For example for problem 17 in this section we proceed as follows:

- i. Input the 4×4 matrix `(STO▶) A2117 (ENTER)`
- ii. Check that the matrix A2117 printed on the TI-85 screen is correct
- iii. Enter `det A2117 (ENTER)` to calculate the determinant.

There are several ways to invoke the `det` function on the TI-85. Either you can use the `det` entry from the **MATRIX MATH** menu via the keystrokes:

`(2nd) (MATRX) (F3) <MATH> (F1) <det>`,

or you can enter the function name `det` directly, followed by a space, by entering:

`(ALPHA) (2nd) (alpha) det.`

After each of these you need to enter `(ALPHA)` to be ready to enter the variable name.

17. Enter `[[1, -1, 2, 3, 5] [6, 10, -6, 4, 3] [7, -1, 2, -12, 6] [9, 4, 13, 8, 15] [8, 11, -9, -8, 6]] (STO▶) A2117`,
then the determinant is given by `det A2117 (ENTER)` : 40954.

18. Enter `[[1, -1, 4, 6] [2, 9, 16, 4] [37, -6, 0, 23] [14, 4, 6, -11]] (STO▶) A2118`,
then the determinant is given by `det A2118 (ENTER)` : 31202.

19. Enter `[[-238, -159, 146, 382, -189] [-319, 248, -556, 700, 682] [462, 96, -331, 516, -322]
[511, 856, 619, 384, 906] [603, -431, -236, 692, -857]] (STO▶) A2119`,
then the determinant is given by `det A2119 (ENTER)` : 1.91524617423E14.

20. Enter `[[.62, .37, .42, .56, .33] [.29, .46, .33, .48, .97] [.81, .37, .91, .33, .77] [.35, .62, .73, .98, .18]
[.29, 8E-2, .46, .71, .29]] (STO▶) A2120`,
then the determinant is given by `det A2120 (ENTER)` : .0879836043.

MATLAB 2.1

1. (a)
(i)

```
>> A = [ -6 4 0; -9 9 7; 4 -2 -9]; % Matrix (i)
>> rref(A)
ans =
     1     0     0
     0     1     0
     0     0     1
```

Matrix is invertible.

```
>> det(A)
ans =
    190
```

Note $\det(A) \neq 0$

(ii)

```
>> A = [ -9 -2 2 -8; 1 -9 9 3; 3 -2 7 -2; -10 4 1 4]; % Matrix (ii)
>> rref(A)
ans =
     1     0     0     0
     0     1     0     0
     0     0     1     0
     0     0     0     1
```

Invertible.

```
>> det(A)
ans =
    8130
```

$\det(A) \neq 0$

(iii)

```
>> A = [ 23 19 11; 5 1 5; 9 9 3]; % Matrix (iii)
>> rref(A)
ans =
    1.0000     0    1.1667
         0    1.0000   -0.8333
         0     0         0
```

Not invertible only 2 pivots

```
>> det(A)
ans =
     0
```

% Matrix (iv)

(iv)

```
>> A = [ 8 -3 5 -9 5; 5 3 8 3 0; -5 5 0 8 -5; -9 10 1 -5 -5; 5 -3 2 -1 -3];
>> rref(A)
ans =
     1     0     1     0     0
     0     1     1     0     0
     0     0     0     1     0
     0     0     0     0     1
     0     0     0     0     0
```

Not invertible.

```
>> det(A)
ans =
     0
```

(v)

```
>> A = [ 1 2 -3 4 5; -2 -5 8 -8 -9; 1 2 -2 7 9; 1 1 0 6 12; 2 4 -6 8 11];
>> rref(A)
ans =
     1     0     0     0     0
     0     1     0     0     0
     0     0     1     0     0
     0     0     0     1     0
     0     0     0     0     1
```

Invertible.

```
>> det(A)
ans =
     1
```

The matrices in (i), (ii), and (v) were invertible. These were also the matrices with nonzero determinant. A matrix is invertible if and only if its determinant is nonzero.

(b) (i)

```
>> A = round( 10*(2*rand(4)-1))
A =
    -6     9    -9   -10
    -9    -2    -9    -2
     4     0     1    -9
     4     7     3    -2

>> rref(A)
ans =
     1     0     0     0
     0     1     0     0
     0     0     1     0
     0     0     0     1
```

Invertible.

```
>> det(A)
ans =
    88
```

For almost any random matrix, $\det(A)$ will be nonzero and A will be invertible.

(ii)

```
>> B = round( 10*(2*rand(4)-1));
>> B(:,3) = B(:,1) + 2*B(:,2)
B =
     4     1     6    -9
     2    -8   -14     5
     9     3    15    -3
     7    -2     3     3
```

```
>> rref(B)
ans =
     1     0     1     0
     0     1     2     0
     0     0     0     1
     0     0     0     0
```

As expected, less than 4 pivots so not invertible.

```
>> det(B)
ans =
     0
```

The determinant of B will always be zero and B will not be invertible.

2. (i)

```
>> A = round( 10*(2*rand(4)-1)) % Probably an invertible matrix.
A =
     5    10    -9    -1
    10     4     3     5
    -3     5     8     0
    -5     3    -5    -5
```

```
>> det(A)
ans =
   1458
```

```
>> det(A')
ans =
   1458
```

```
>> B = round( 10*(2*rand(4)-1)); % A singular matrix.
>> B(:,3) = B(:,1) + 2*B(:,2)
B =
    -5     8    11     0
    -3     8    13    -5
    -7    -9   -25    -8
     0     8    16     9
```

```

>> det(B)
ans =
    0
>> det(B')
ans =
    0

>> A = round( 10*((2*rand(3)-1)+i*(2*rand(3)-1))) % A complex matrix.
A =
   -1.0000 + 9.0000i   -7.0000 + 8.0000i   -9.0000 - 7.0000i
   -4.0000 + 5.0000i    1.0000 + 2.0000i    1.0000 - 6.0000i
   -6.0000 + 1.0000i    6.0000 + 7.0000i         0 + 4.0000i

>> det(A)
ans =
  -2.5500e+02- 5.0800e+02i
>> det(A')
ans =
  -2.5500e+02+ 5.0800e+02i
>> det(A.')
ans =
  -2.5500e+02- 5.0800e+02i

```

For real matrices, $\det(A) = \det(A')$. This is also true if A is not invertible. For complex matrices, $\det(A')$ is the complex conjugate of $\det(A)$, since in MATLAB A' is the conjugate transpose. Recall from 1.9 that $A.'$ is the way to get MATLAB to compute A' .

3.

```

>> A = round( 10*(2*rand(3)-1))
A =
   -7   -10    4
   -8    -2    9
   -5    -9   -5

>> B = round( 10*(2*rand(3)-1))
B =
   -6    3   -2
   -4   -7   -2
    8    4    0

>> C = A+B
C =
  -13   -7    2
  -12   -9    7
    3   -5   -5

>> det(C)
ans =
  -593

>> det(A) + det(B)
ans =
   285

```

The statement is not true: $\det(A + B)$ is not the same as $\det(A) + \det(B)$.

4. (a)
(i)

```
>> A = [ 2 7 5; 0 9 8; 7 4 0]; % Part (i)
>> B = [ 1 4 2; -1 -2 1; 1 6 6 ];
>> det(A)
ans =
    13

>> det(B)
ans =
     2
>> det(A*B)
ans =
    26

>> det(A)*det(B)
ans =
    26
```

(ii)

```
>> A = [ 2 7 5; 0 9 8; 7 4 0]; % Part (ii)
>> B = [ 1 2 5; 1 -1 4; 2 4 11];
>> det(A)
ans =
    13

>> det(B)
ans =
    -3

>> det(A*B)
ans =
   -39

>> det(A)*det(B)
ans =
   -39
```

(iii)

```
>> A = [ 1 2 5; 1 -1 4; 2 4 11]; % Part (ii)
>> B = [ 1 4 2; -1 -2 1; 1 6 6 ];
>> det(A)
ans =
    -3

>> det(B)
ans =
     2

>> det(A*B)
ans =
    -6

>> det(A)*det(B)
ans =
    -6
```

(iv)

```

>> A = [ 10 6 4 1; 1 1 0 0; 2 7 -5 9; 3 6 -3 4];
>> B = [ 1 9 4 5; 9 1 3 3; 4 2 1 5; 1 1 8 8];
>> det(A)
ans =
    0
>> det(B)
ans =
    2226
>> det(A*B)
ans =
    0
>> det(A)*det(B)
ans =
    0

```

In each case $\det(AB) = \det(A)\det(B)$. This will be true for any square matrices of the same size.

(b) The conjecture stated in (a) will always hold.

5. (A)

(i)

```

>> A = [2 2; 1 2];
>> det(A)
ans =
    2
>> det(inv(A))
ans =
    0.5000
>> 1 / det(A)
ans =
    0.5000

```

(ii)

```

>> A = [2 -1; 1 -2];
>> det(A)
ans =
   -3
>> det(inv(A))
ans =
  -0.3333
>> 1 / det(A)
ans =
  -0.3333

```

(iii)

```

>> A = [2 1 2; -2 0 3; 2 1 4];
>> det(A)
ans =
    4
>> det(inv(A))
ans =
    0.2500

```

```
>> 1 / det(A)
ans =
    0.2500
```

(iv)

```
>> A = [ -1 1 2; 1 -2 1; -2 2 9];
>> det(A)
ans =
     5
>> det(inv(A))
ans =
    0.2000

>> 1 / det(A)
ans =
    0.2000
```

For any invertible matrix A , the formula $1/\det(A) = \det(A^{-1})$ will be valid.

- (b) This formula will be true for any random matrix.
 (c) From problem 4 we believe that $\det(AB) = \det(A)\det(B)$, if we let $B = A^{-1}$, and recall that $\det(I) = 1$, we have

$$1 = \det(I) = \det(AA^{-1}) = \det(A)\det(A^{-1}).$$

Divide both sides by $\det(A)$ and the “proof” is completed.

6.

```
>> A = 2*rand(6)-1
A =
   -0.6756   -0.0894   -0.5695    0.0119    0.2655    0.9088
   -0.8579   -0.3010    0.3592    0.2008   -0.1213    0.7025
   -0.2693   -0.0954    0.8178    0.6351    0.6494   -0.4214
   -0.4939    0.6179   -0.4997    0.5117    0.3780    0.0749
   -0.7298    0.8633    0.7217   -0.0755    0.4044    0.0289
    0.5663    0.3033   -0.0575    0.9027    0.9743   -0.7931
```

(a)

```
>> i = 3; j = 2; c = 2.5;          % For part (a)
>> B = A; B(j,:) = B(j,:) + c*B(i,:)
B =
   -0.6756   -0.0894   -0.5695    0.0119    0.2655    0.9088
   -1.5312   -0.5395    2.4038    1.7886    1.5021   -0.3509
   -0.2693   -0.0954    0.8178    0.6351    0.6494   -0.4214
   -0.4939    0.6179   -0.4997    0.5117    0.3780    0.0749
   -0.7298    0.8633    0.7217   -0.0755    0.4044    0.0289
    0.5663    0.3033   -0.0575    0.9027    0.9743   -0.7931

>> det(A)
ans =
   -0.2781

>> det(B)
ans =
   -0.2781
```

Adding a multiple of one row to another does not change the determinant.

(b)

```

>> i = 3; c = 2.0;           % For part (b)
>> B = A; B(i,:) = c*B(i,:)
B =
   -0.6756   -0.0894   -0.5695    0.0119    0.2655    0.9088
   -0.8579   -0.3010    0.3592    0.2008   -0.1213    0.7025
   -0.5386   -0.1908    1.6357    1.2702    1.2988   -0.8427
   -0.4939    0.6179   -0.4997    0.5117    0.3780    0.0749
   -0.7298    0.8633    0.7217   -0.0755    0.4044    0.0289
    0.5663    0.3033   -0.0575    0.9027    0.9743   -0.7931

>> det(A)
ans =
   -0.2781

>> det(B)
ans =
   -0.5562

```

Multiplying a row by c multiplies the determinant by c .

(c)

```

>> i = 5; j = 1;           % For part (c)
>> B = A; B([i j],:) = B([j i],:)
B =
   -0.7298    0.8633    0.7217   -0.0755    0.4044    0.0289
   -0.8579   -0.3010    0.3592    0.2008   -0.1213    0.7025
   -0.2693   -0.0954    0.8178    0.6351    0.6494   -0.4214
   -0.4939    0.6179   -0.4997    0.5117    0.3780    0.0749
   -0.6756   -0.0894   -0.5695    0.0119    0.2655    0.9088
    0.5663    0.3033   -0.0575    0.9027    0.9743   -0.7931

>> det(A)
ans =
   -0.2781

>> det(B)
ans =
    0.2781

```

Interchanging two rows multiplies the determinant by -1 .

(d)

```

>> i = 3; j = 2; c = 2.5;   % For part (a)
>> F = eye(6); F(j,i) = c
F =
   1.0000    0    0    0    0    0
    0    1.0000   2.5000    0    0    0
    0    0    1.0000    0    0    0
    0    0    0    1.0000    0    0
    0    0    0    0    1.0000    0
    0    0    0    0    0    1.0000

>> det(F)
ans =
    1

```

```

>> i = 3; c = 2.0;                % For part (b)
>> F = eye(6); F(i,i) = c
F =
    1    0    0    0    0    0
    0    1    0    0    0    0
    0    0    1    0    0    0
    0    0    0    1    0    0
    0    0    0    0    2    0
    0    0    0    0    0    1

>> det(F)
ans =
     2

>> i = 5; j = 1;                  % For part (c)
>> F = eye(6); F([i j],:) = F([j i],:)
F =
    0    0    0    0    1    0
    0    1    0    0    0    0
    0    0    1    0    0    0
    0    0    0    1    0    0
    1    0    0    0    0    0
    0    0    0    0    0    1

>> det(F)
ans =
    -1

```

Since $B = FA$, from problem 4 we expect that $\det(B) = \det(F) \det(A)$. The elementary matrices in part (a) all have determinant 1, those in (b) have determinant c , and those in (c) all have determinant -1 .

7. The determinant of M will be $\det(A) \det(D)$.
(a)

```

>> A = round(10*(2*rand(2)-1) )
A =
   -6   -7
   10    3

>> B = round(10*(2*rand(2)-1) )
B =
     2  -10
   -10    5

>> C = zeros(2);
>> D = round(10*(2*rand(2)-1) )
D =
     5   -2
    -4    4

>> M = [ A B; C D];
>> det(A), det(B), det(D)
ans =
     52
ans =
   -90
ans =
     12

```

```

>> det(M)
ans =
    624

>> det(A)*det(D)
ans =
    624

```

This experiment agrees with the conjecture.

(b) As above, The following experiment leads us to believe $\det(M) = \det(A) \det(D) \det(F)$.

```

>> n = 3;
>> A = round(10*(2*rand(n)-1) );
>> B = round(10*(2*rand(n)-1) );
>> C = round(10*(2*rand(n)-1) );
>> D = round(10*(2*rand(n)-1) );
>> E = round(10*(2*rand(n)-1) );
>> F = round(10*(2*rand(n)-1) );
>> Z = zeros(n);
>> M = [ A B C; Z D E; Z Z F]
M =
   -10    -5    -2     7    -5    -6     6     3     2
    -6     6     2    -7    -5     3     4     3    -5
    10    -7    -6    10    -8     4     5    -9    -4
     0     0     0     4     1    -3    -7     6    -4
     0     0     0    -8     1     4     0     1    -7
     0     0     0     5     2    -7     7     5     1
     0     0     0     0     0     0    -4    -1    -2
     0     0     0     0     0     0     2    -5    -1
     0     0     0     0     0     0     0    -3     0

>> det(M)
ans =
   -266112

>> det(A)*det(D)*det(F)
ans =
   -266112

```

8. (a)

```

>> A = [1 1; 1 2];
>> det(A)
ans =
     1

>> u1 = [1;0] ; v1 = [0; 1];
>> ornt(u1,v1,A) % For Student MATLAB use a screen dump to save
>> print -deps fig218ai.eps

```

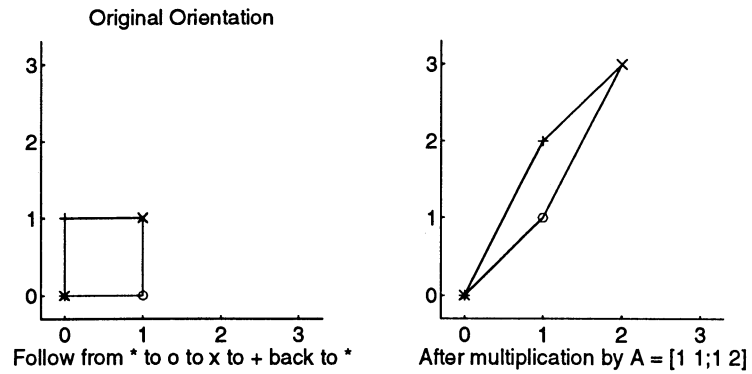
```
>> u2 = [-2;1]; v2 = [1;3];
>> ornt(u2,v2,A)
>> print -deps fig218aai.eps
```

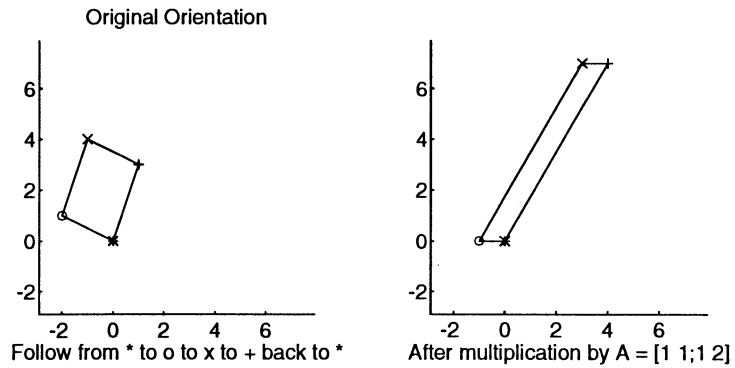

The first ornt call gives two graphs, one of a square, and one of a parallelogram. Both are oriented counterclockwise. While the second ornt call gives two parallelograms, oriented in the same manner.

(b)

```
>> A = [2 3; 2 2];
>> det(A)
ans =
    -2
>> ornt(u1,v1,A)
>> print -deps fig218bi.eps
```

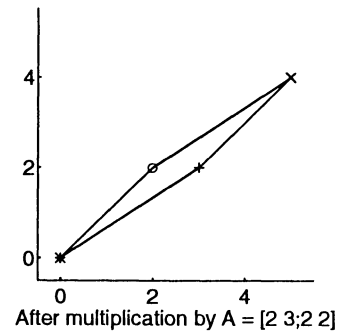
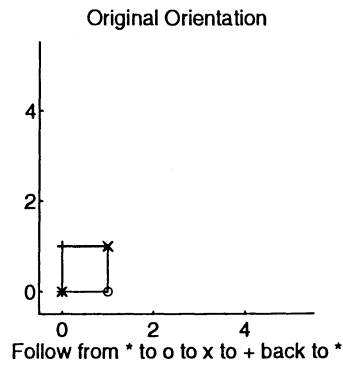

```
>> u2 = [-2;1]; v2 = [1;3];
>> ornt(u2,v2,A)
>> print -deps fig218bii.eps
```

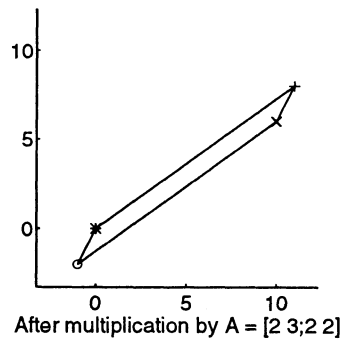
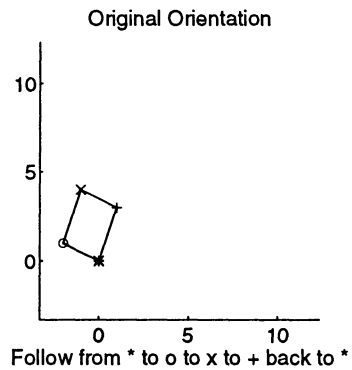

Here the two parallelograms in each ornt call have opposite orientation.

(c)

```
>> A = [1 0; 3 -1];
>> det(A)
ans =
    -1
>> ornt(u1,v1,A)
>> print -deps fig218ci.eps
```

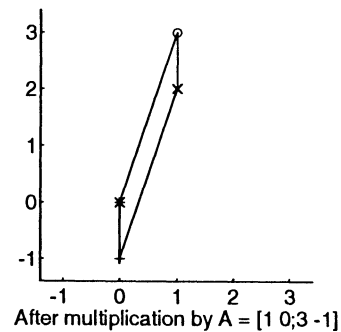
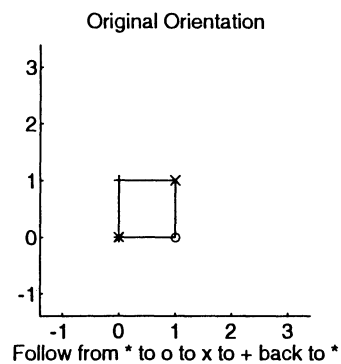

```
>> u2 = [-2;1]; v2 = [1;3];
>> ornt(u2,v2,A)
>> print -deps fig218cii.eps
```

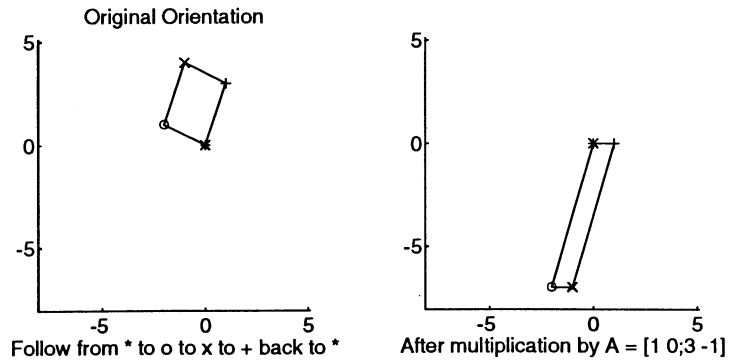

(d)

```
>> A = [1 2; 1 4];
>> det(A)
ans =
     2
>> ornt(u1,v1,A)
>> print -deps fig218di.eps
```

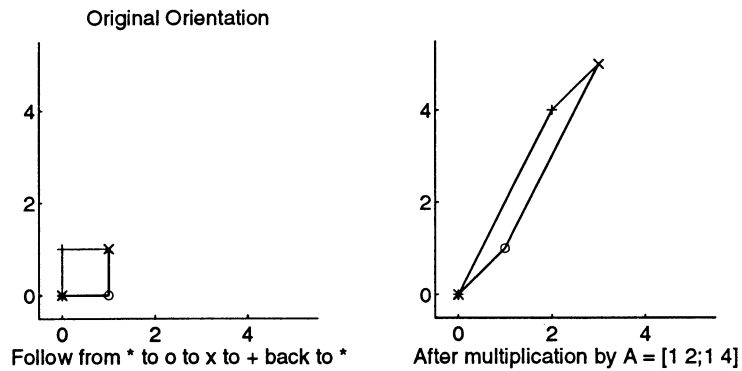

```
>> u2 = [-2;1]; v2 = [1;3];
>> ornt(u2,v2,A)
>> print -deps fig218dii.eps
```

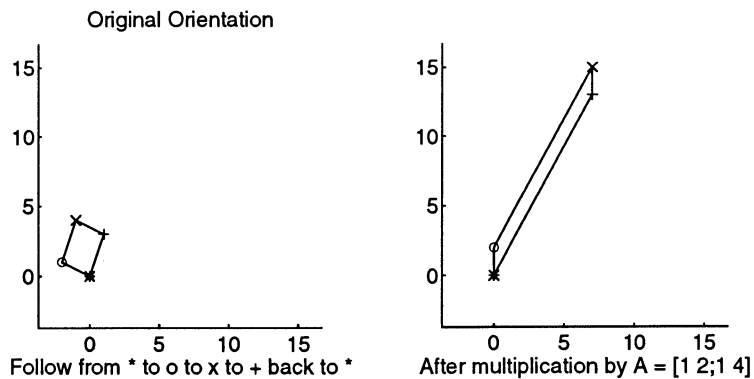

In (c) they have opposite orientation, and in (d) they have the same orientation. The two parallelograms will have the same orientation if $\det(A) > 0$ and they will have opposite orientation if $\det(A) < 0$.

(e) This will hold true for any invertible matrix A .

Section 2.2

$$1. 3 \cdot 6 - 2 \cdot (-5) = 28 \quad 2. 4 \cdot (-3) - 0 \cdot 1 = -12 \quad 3. \begin{vmatrix} -1 & 0 & 2 \\ 3 & 1 & 4 \\ 2 & 0 & -6 \end{vmatrix} = \begin{vmatrix} -1 & 2 \\ 2 & -6 \end{vmatrix} = 2$$

$$4. \begin{vmatrix} 2 & 1 & -1 \\ 3 & -2 & 0 \\ 5 & 1 & 6 \end{vmatrix} = \begin{vmatrix} 2 & 1 & -1 \\ 3 & -2 & 0 \\ 17 & 7 & 0 \end{vmatrix} = (-1) \begin{vmatrix} 3 & -2 \\ 17 & 7 \end{vmatrix} = -55$$

$$5. \begin{vmatrix} -3 & 2 & 4 \\ 1 & -1 & 2 \\ -1 & 4 & 0 \end{vmatrix} = \begin{vmatrix} -5 & 4 & 0 \\ 1 & -1 & 2 \\ -1 & 4 & 0 \end{vmatrix} = (-2) \begin{vmatrix} -5 & 4 \\ -1 & 4 \end{vmatrix} = 32$$

$$6. \begin{vmatrix} 0 & -2 & 3 \\ 1 & 2 & -3 \\ 4 & 0 & 5 \end{vmatrix} = (2) \begin{vmatrix} 0 & -1 & 3 \\ 1 & 1 & -3 \\ 0 & -4 & 17 \end{vmatrix} = (-2) \begin{vmatrix} -1 & 3 \\ -4 & 17 \end{vmatrix} = 10 \text{ (factor 2 from col. 2, then } R_3 - 4R_2)$$

$$7. (-2) \begin{vmatrix} 3 & 6 \\ 1 & 8 \end{vmatrix} = -36 \text{ (Row 3 expansion).}$$

$$8. \begin{vmatrix} 2 & -1 & 3 \\ 4 & 0 & 6 \\ 5 & -2 & 3 \end{vmatrix} \stackrel{R_2 - 2R_1}{=} \begin{vmatrix} 2 & -1 & 3 \\ 0 & 2 & 0 \\ 5 & -2 & 3 \end{vmatrix} = 2 \begin{vmatrix} 2 & 3 \\ 5 & 3 \end{vmatrix} = -18 \text{ (Expand along row 2 at second step).}$$

$$9. \begin{vmatrix} 1 & -1 & 2 & 4 \\ 0 & -3 & 5 & 6 \\ 1 & 4 & 0 & 3 \\ 0 & 5 & -6 & 7 \end{vmatrix} \stackrel{R_3 - R_1}{=} \begin{vmatrix} 1 & -1 & 2 & 4 \\ 0 & -3 & 5 & 6 \\ 0 & 5 & -2 & -1 \\ 0 & 5 & -6 & 7 \end{vmatrix} \stackrel{R_4 - R_3}{=} \begin{vmatrix} -3 & 5 & 6 \\ 5 & -2 & -1 \\ 0 & -4 & 8 \end{vmatrix}$$

$$c_3 + 2c_2 \begin{vmatrix} -3 & 5 & 16 \\ 5 & -2 & -5 \\ 0 & -4 & 0 \end{vmatrix} = 4 \begin{vmatrix} -3 & 16 \\ 5 & -5 \end{vmatrix} = -260$$

$$10. \begin{vmatrix} 2 & -3 & 1 & 4 \\ 0 & -2 & 0 & 0 \\ 3 & 7 & -1 & 2 \\ 4 & 1 & -3 & 8 \end{vmatrix} \stackrel{R_2 \cdot (-2)}{=} \begin{vmatrix} 2 & 1 & 4 \\ 3 & -1 & 2 \\ 4 & -3 & 8 \end{vmatrix} \stackrel{R_3 - 2R_1}{=} \begin{vmatrix} 2 & 1 & 4 \\ 3 & -1 & 2 \\ 0 & -5 & 0 \end{vmatrix} = (-2) \cdot 5 \begin{vmatrix} 2 & 4 \\ 3 & 2 \end{vmatrix} = 80$$

$$11. \begin{vmatrix} 1 & 1 & -1 & 0 \\ -3 & 4 & 6 & 0 \\ 2 & 5 & -1 & 3 \\ 4 & 0 & 3 & 0 \end{vmatrix} = -3 \begin{vmatrix} 1 & 1 & -1 \\ -3 & 4 & 6 \\ 4 & 0 & 3 \end{vmatrix} = -3 \begin{vmatrix} 1 & 1 & -1 \\ -7 & 0 & 10 \\ 4 & 0 & 3 \end{vmatrix} = 3 \begin{vmatrix} -7 & 10 \\ 4 & 3 \end{vmatrix} = -183$$

$$12. \begin{vmatrix} 3 & -1 & 2 & 1 \\ 4 & 3 & 1 & -2 \\ -1 & 0 & 2 & 3 \\ 6 & 2 & 5 & 2 \end{vmatrix} = \begin{vmatrix} 3 & -1 & 2 & 1 \\ 13 & 0 & 7 & 1 \\ -1 & 0 & 2 & 3 \\ 12 & 0 & 9 & 4 \end{vmatrix} = \begin{vmatrix} 13 & 7 & 1 \\ -1 & 2 & 3 \\ 12 & 9 & 4 \end{vmatrix} = \begin{vmatrix} 13 & 7 & 1 \\ -1 & 2 & 3 \\ -1 & 2 & 3 \end{vmatrix} = 0$$

$$13. \begin{vmatrix} 2 & 0 & 0 & 0 \\ 0 & 0 & 3 & 0 \\ 0 & -1 & 0 & 0 \\ 0 & 0 & 0 & 4 \end{vmatrix} = (-1) \begin{vmatrix} 2 & 0 & 0 & 0 \\ 0 & -1 & 0 & 0 \\ 0 & 0 & 3 & 0 \\ 0 & 0 & 0 & 4 \end{vmatrix} = 24$$

$$14. \begin{vmatrix} 0 & a & 0 & 0 \\ b & 0 & 0 & 0 \\ 0 & 0 & 0 & c \\ 0 & 0 & d & 0 \end{vmatrix} = \begin{vmatrix} b & 0 & 0 & 0 \\ 0 & a & 0 & 0 \\ 0 & 0 & d & 0 \\ 0 & 0 & 0 & c \end{vmatrix} = abcd \text{ (Two interchanges } (-1)(-1) = 1.)$$

$$15. \begin{vmatrix} 1 & 2 & 0 & 0 \\ 3 & -2 & 0 & 0 \\ 0 & 0 & 1 & -5 \\ 0 & 0 & 7 & 2 \end{vmatrix} = \begin{vmatrix} 1 & 2 & 0 & 0 \\ 0 & -8 & 0 & 0 \\ 0 & 0 & 1 & -5 \\ 0 & 0 & 0 & 37 \end{vmatrix} = -296$$

$$16. \begin{vmatrix} a & b & 0 & 0 \\ c & d & 0 & 0 \\ 0 & 0 & a & -b \\ 0 & 0 & c & d \end{vmatrix} = a \begin{vmatrix} d & 0 & 0 \\ 0 & a & -b \\ 0 & c & d \end{vmatrix} - b \begin{vmatrix} c & 0 & 0 \\ 0 & a & -b \\ 0 & c & d \end{vmatrix} = ad(ad + bc) - bc(ad + bc) = a^2d^2 - b^2c^2$$

$$17. \begin{vmatrix} 2 & -1 & 0 & 4 & 1 \\ 3 & 1 & -1 & 2 & 0 \\ 3 & 2 & -2 & 5 & 1 \\ 0 & 0 & 4 & -1 & 6 \\ 3 & 2 & 1 & -1 & 1 \end{vmatrix} = \begin{vmatrix} 2 & -1 & 16 & 4 & 25 \\ 3 & 1 & 7 & 2 & 12 \\ 3 & 2 & 18 & 5 & 31 \\ 0 & 0 & 0 & -1 & 0 \\ 3 & 2 & -3 & -1 & -5 \end{vmatrix} = (-1) \begin{vmatrix} 5 & 0 & 23 & 37 \\ 3 & 1 & 7 & 12 \\ -3 & 0 & 4 & 7 \\ -3 & 0 & -17 & -29 \end{vmatrix}$$

$$= (-1) \begin{vmatrix} 5 & 28 & 37 \\ -3 & 1 & 7 \\ -3 & -20 & -29 \end{vmatrix} = (-1) \begin{vmatrix} 89 & 28 & -159 \\ 0 & 1 & 0 \\ -63 & -20 & 111 \end{vmatrix} = 138$$

$$18. \begin{vmatrix} 1 & -1 & 2 & 0 & 0 \\ 3 & 1 & 4 & 0 & 0 \\ 2 & -1 & 5 & 0 & 0 \\ 0 & 0 & 0 & 2 & 3 \\ 0 & 0 & 0 & -1 & 4 \end{vmatrix} = \begin{vmatrix} 1 & -1 & 2 & 0 & 0 \\ 0 & 4 & -2 & 0 & 0 \\ 0 & 1 & 1 & 0 & 0 \\ 0 & 0 & 0 & 0 & 11 \\ 0 & 0 & 0 & -1 & 4 \end{vmatrix} = (-1) \begin{vmatrix} 1 & -3 & 2 & 0 & 0 \\ 0 & 6 & -2 & 0 & 0 \\ 0 & 0 & 1 & 0 & 0 \\ 0 & 0 & 0 & -1 & 4 \\ 0 & 0 & 0 & 0 & 11 \end{vmatrix} = 66$$

$$19. \begin{vmatrix} a & 0 & 0 & 0 & 0 \\ 0 & 0 & b & 0 & 0 \\ 0 & 0 & 0 & 0 & c \\ 0 & 0 & 0 & d & 0 \\ 0 & e & 0 & 0 & 0 \end{vmatrix} = (-1) \begin{vmatrix} a & 0 & 0 & 0 & 0 \\ 0 & e & 0 & 0 & 0 \\ 0 & 0 & 0 & 0 & c \\ 0 & 0 & 0 & d & 0 \\ 0 & 0 & b & 0 & 0 \end{vmatrix} = \begin{vmatrix} a & 0 & 0 & 0 & 0 \\ 0 & e & 0 & 0 & 0 \\ 0 & 0 & b & 0 & 0 \\ 0 & 0 & 0 & d & 0 \\ 0 & 0 & 0 & 0 & c \end{vmatrix} = abcde$$

$$20. \begin{vmatrix} 2 & 5 & -6 & 8 & 0 \\ 0 & 1 & -7 & 6 & 0 \\ 0 & 0 & 0 & 4 & 0 \\ 0 & 2 & 1 & 5 & 1 \\ 4 & -1 & 5 & 3 & 0 \end{vmatrix} = (-1) \begin{vmatrix} 2 & 5 & -6 & 8 \\ 0 & 1 & -7 & 6 \\ 0 & 0 & 0 & 4 \\ 4 & -1 & 5 & 3 \end{vmatrix} = 4 \begin{vmatrix} 2 & 5 & -6 \\ 0 & 1 & -7 \\ 4 & -1 & 5 \end{vmatrix}$$

$$= 4 \begin{vmatrix} 2 & 5 & 29 \\ 0 & 1 & 0 \\ 4 & -1 & -2 \end{vmatrix} = -480$$

$$21. \begin{vmatrix} a_{31} & a_{32} & a_{33} \\ a_{21} & a_{22} & a_{23} \\ a_{11} & a_{12} & a_{13} \end{vmatrix} = (-1) \begin{vmatrix} a_{11} & a_{12} & a_{13} \\ a_{21} & a_{22} & a_{23} \\ a_{31} & a_{32} & a_{33} \end{vmatrix} = -8 (R_1 \leftrightarrow R_3)$$

$$22. \begin{vmatrix} a_{31} & a_{32} & a_{33} \\ a_{11} & a_{12} & a_{13} \\ a_{21} & a_{22} & a_{23} \end{vmatrix} = (-1) \begin{vmatrix} a_{11} & a_{12} & a_{13} \\ a_{31} & a_{32} & a_{33} \\ a_{21} & a_{22} & a_{23} \end{vmatrix} = (-1)^2 \begin{vmatrix} a_{11} & a_{12} & a_{13} \\ a_{21} & a_{22} & a_{23} \\ a_{31} & a_{32} & a_{33} \end{vmatrix} = 8 (R_1 \leftrightarrow R_2, \text{ then } R_2 \leftrightarrow R_3).$$

$$23. \begin{vmatrix} a_{11} & a_{12} & a_{13} \\ 2a_{21} & 2a_{22} & 2a_{23} \\ a_{31} & a_{32} & a_{33} \end{vmatrix} = 2 \begin{vmatrix} a_{11} & a_{12} & a_{13} \\ a_{21} & a_{22} & a_{23} \\ a_{31} & a_{32} & a_{33} \end{vmatrix} = 16 (\text{Factor } 2 \text{ from } R_2)$$

$$24. \begin{vmatrix} -3a_{11} & -3a_{12} & -3a_{13} \\ 2a_{21} & 2a_{22} & 2a_{23} \\ 5a_{31} & 5a_{32} & 5a_{33} \end{vmatrix} = (-3) \cdot 2 \cdot 5 \begin{vmatrix} a_{11} & a_{12} & a_{13} \\ a_{21} & a_{22} & a_{23} \\ a_{31} & a_{32} & a_{33} \end{vmatrix} = -240 (\text{Factor, } -3, 2, 5 \text{ from rows.})$$

$$25. \begin{vmatrix} a_{11} & 2a_{13} & a_{12} \\ a_{21} & 2a_{23} & a_{22} \\ a_{31} & 2a_{33} & a_{32} \end{vmatrix} = 2 \begin{vmatrix} a_{11} & a_{13} & a_{12} \\ a_{21} & a_{23} & a_{22} \\ a_{31} & a_{33} & a_{32} \end{vmatrix} = -2 \begin{vmatrix} a_{11} & a_{12} & a_{13} \\ a_{21} & a_{22} & a_{23} \\ a_{31} & a_{32} & a_{33} \end{vmatrix} = -16 \text{ (Factor 2 from } C_2 \leftrightarrow C_3.)$$

$$26. \begin{vmatrix} a_{11} - a_{12} & a_{12} & a_{13} \\ a_{21} - a_{22} & a_{22} & a_{23} \\ a_{31} - a_{32} & a_{32} & a_{33} \end{vmatrix} = \begin{vmatrix} a_{11} & a_{12} & a_{13} \\ a_{21} & a_{22} & a_{23} \\ a_{31} & a_{32} & a_{33} \end{vmatrix} = 8 \text{ (Add } C_2 \text{ to } C_1.)$$

$$27. \begin{vmatrix} 2a_{11} - 3a_{21} & 2a_{12} - 3a_{22} & 2a_{13} - 3a_{23} \\ a_{31} & a_{32} & a_{33} \\ a_{21} & a_{22} & a_{23} \end{vmatrix} \begin{matrix} R_1 + 3R_3 \\ R_2 \leftrightarrow R_3 \end{matrix} (-1) \begin{vmatrix} 2a_{11} & 2a_{12} & 2a_{13} \\ a_{21} & a_{22} & a_{23} \\ a_{31} & a_{32} & a_{33} \end{vmatrix} = -16 \text{ (Factor } R_1)$$

$$\begin{aligned} 28. \det \alpha A &= \det \alpha \begin{pmatrix} a_{11} & a_{12} & \cdots & a_{1n} \\ a_{21} & a_{22} & \cdots & a_{2n} \\ \vdots & \vdots & & \vdots \\ a_{n1} & a_{n2} & \cdots & a_{nn} \end{pmatrix} = \det \begin{pmatrix} \alpha a_{11} & \alpha a_{12} & \cdots & \alpha a_{1n} \\ \alpha a_{21} & \alpha a_{22} & \cdots & \alpha a_{2n} \\ \vdots & \vdots & & \vdots \\ \alpha a_{n1} & \alpha a_{n2} & \cdots & \alpha a_{nn} \end{pmatrix} \\ &= \alpha \det \begin{pmatrix} a_{11} & a_{12} & \cdots & a_{1n} \\ \alpha a_{21} & \alpha a_{22} & \cdots & \alpha a_{2n} \\ \vdots & \vdots & & \vdots \\ \alpha a_{n1} & \alpha a_{n2} & \cdots & \alpha a_{nn} \end{pmatrix} = \alpha^2 \det \begin{pmatrix} a_{11} & a_{12} & \cdots & a_{1n} \\ a_{21} & a_{22} & \cdots & a_{2n} \\ \alpha a_{31} & \alpha a_{32} & \cdots & \alpha a_{3n} \\ \vdots & \vdots & & \vdots \\ \alpha a_{n1} & \alpha a_{n2} & \cdots & \alpha a_{nn} \end{pmatrix} \\ &= \cdots = \alpha^n \det \begin{pmatrix} a_{11} & a_{12} & \cdots & a_{1n} \\ a_{21} & a_{22} & \cdots & a_{2n} \\ \vdots & \vdots & & \vdots \\ a_{n1} & a_{n2} & \cdots & a_{nn} \end{pmatrix} = \alpha^n \det A \end{aligned}$$

29. Use induction on n . If $n = 2$, then $\begin{vmatrix} 1 + x_1 & x_2 \\ x_1 & 1 + x_2 \end{vmatrix} = 1 + x_1 + x_2$. Suppose for $n - 1$, the determinant is $1 + x_1 + x_2 + \cdots + x_{n-1}$.

$$\begin{vmatrix} 1 + x_1 & x_2 & x_3 & \cdots & x_n \\ x_1 & 1 + x_2 & x_3 & \cdots & x_n \\ x_1 & x_2 & 1 + x_3 & \cdots & x_n \\ \vdots & \vdots & \vdots & & \vdots \\ x_1 & x_2 & x_3 & \cdots & 1 + x_n \end{vmatrix} = \begin{vmatrix} 1 & -1 & 0 & \cdots & 0 \\ x_1 & 1 + x_2 & x_3 & \cdots & x_n \\ x_1 & x_2 & 1 + x_3 & \cdots & x_n \\ \vdots & \vdots & \vdots & & \vdots \\ x_1 & x_2 & x_3 & \cdots & 1 + x_n \end{vmatrix}$$

$$\begin{vmatrix} 1 & 0 & 0 & \cdots & 0 \\ x_1 & 1 + x_1 + x_2 & x_3 & \cdots & x_n \\ x_1 & x_1 + x_2 & 1 + x_3 & \cdots & x_n \\ \vdots & \vdots & \vdots & & \vdots \\ x_1 & x_1 + x_2 & x_3 & \cdots & 1 + x_n \end{vmatrix} = \begin{vmatrix} 1 + x_1 + x_2 & x_3 & \cdots & x_n \\ x_1 + x_2 & 1 + x_3 & \cdots & x_n \\ \vdots & \vdots & & \vdots \\ x_1 + x_2 & x_3 & \cdots & 1 + x_n \end{vmatrix}$$

By the induction hypothesis, this determinant $= 1 + x_1 + x_2 + \cdots + x_n$.

30. By theorem 3, $\det A = \det A^t$. But, $\det A^t = \det (-1)A$. By problem 28, $\det (-1)A = (-1)^n \det A$. Hence, $\det A = (-1)^n \det A$.

31. If n is odd, then $\det A = (-1)^n \det A = -\det A$. Hence, $\det A = 0$.

32. By theorem 3, $\det A = \det A^t = \det A^{-1}$. By theorem 4, we have $\det AA^{-1} = (\det A)(\det A^{-1}) = \det I = 1$. Thus, $(\det A)^2 = 1$. It follows that $\det A = \pm 1$.

$$33. \begin{vmatrix} 1 & x_1 & y_1 \\ 1 & x_2 & y_2 \\ 1 & x_3 & y_3 \end{vmatrix} = \begin{vmatrix} 1 & x_1 & y_1 \\ 0 & x_2 - x_1 & y_2 - y_1 \\ 0 & x_3 - x_1 & y_3 - y_1 \end{vmatrix} \stackrel{R_2 - R_1}{=} \begin{vmatrix} 1 & x_1 & y_1 \\ 0 & x_2 - x_1 & y_2 - y_1 \\ 0 & x_3 - x_1 & y_3 - y_1 \end{vmatrix} = \begin{vmatrix} x_2 - x_1 & y_2 - y_1 \\ x_3 - x_1 & y_3 - y_1 \end{vmatrix} = \text{Area of parallelo-}$$

gram generated by $(x_2 - x_1, y_2 - y_1)$ and $(x_3 - x_1, y_3 - y_1)$. A picture shows this parallelogram is 2 similar triangles, so $\pm 1/2$ of the determinant is the area of Δ .

$\det = 0$, exactly when $(x_2 - x_1)(y_3 - y_1) - (x_3 - x_1)(y_2 - y_1) = 0$ or geometrically when two sides are parallel. Since $(x_2 - x_1)(y_3 - y_1) - (x_3 - x_1)(y_2 - y_1) = x_1y_2 + x_2y_3 + x_3y_1 - x_1y_3 - x_2y_1 - x_3y_2$, an equivalent algebraic condition for $\det = 0$ is $x_1y_2 + x_2y_3 + x_3y_1 = x_1y_3 + x_2y_1 + x_3y_2$.

34. We need to find the vertices of the triangle. Consider the lines $a_{11}x + a_{12}y + a_{13} = 0$ and $a_{21}x + a_{22}y + a_{23} = 0$. Since the lines are not parallel, then $a_{11}a_{22} - a_{12}a_{21} = A_{33} \neq 0$ and their point of intersection is given by $\frac{1}{A_{33}} \begin{pmatrix} a_{22} - a_{12} \\ -a_{21} & a_{11} \end{pmatrix} \begin{pmatrix} -a_{13} \\ -a_{23} \end{pmatrix} = \frac{1}{A_{33}} \begin{pmatrix} A_{31} \\ A_{32} \end{pmatrix}$. Show that the other two vertices are given by $\frac{1}{A_{23}} \begin{pmatrix} A_{21} \\ A_{22} \end{pmatrix}$ and $\frac{1}{A_{13}} \begin{pmatrix} A_{11} \\ A_{12} \end{pmatrix}$. By problem 33, the area determined by the lines is

$$\pm \frac{1}{2} \begin{vmatrix} 1 & A_{31}/A_{33} & A_{32}/A_{33} \\ 1 & A_{21}/A_{23} & A_{22}/A_{23} \\ 1 & A_{11}/A_{13} & A_{12}/A_{13} \end{vmatrix} = \frac{\pm 1}{2A_{13}A_{23}A_{33}} \begin{vmatrix} A_{11} & A_{12} & A_{13} \\ A_{21} & A_{22} & A_{23} \\ A_{31} & A_{32} & A_{33} \end{vmatrix} \text{ (factoring denominators from each row).}$$

$$35. D_3 = \begin{vmatrix} 1 & 1 & 1 \\ a_1 & a_2 & a_3 \\ a_1^2 & a_2^2 & a_3^2 \end{vmatrix} = \begin{vmatrix} 1 & 1 & 1 \\ 0 & a_2 - a_1 & a_3 - a_1 \\ 0 & a_2^2 - a_1a_2 & a_3^2 - a_1a_3 \end{vmatrix} \\ = (a_2 - a_1)(a_3 - a_1) \begin{vmatrix} 1 & 1 \\ a_2 & a_3 \end{vmatrix} = (a_2 - a_1)(a_3 - a_1)(a_3 - a_2)$$

$$36. D_4 = \begin{vmatrix} 1 & 1 & 1 & 1 \\ a_1 & a_2 & a_3 & a_4 \\ a_1^2 & a_2^2 & a_3^2 & a_4^2 \\ a_1^3 & a_2^3 & a_3^3 & a_4^3 \end{vmatrix} = \begin{vmatrix} 1 & 1 & 1 & 1 \\ 0 & a_2 - a_1 & a_3 - a_1 & a_4 - a_1 \\ 0 & a_2^2 - a_1a_2 & a_3^2 - a_1a_3 & a_4^2 - a_1a_4 \\ 0 & a_2^3 - a_1a_2^2 & a_3^3 - a_1a_3^2 & a_4^3 - a_1a_4^2 \end{vmatrix} \\ = (a_2 - a_1)(a_3 - a_1)(a_4 - a_1) \begin{vmatrix} 1 & 1 & 1 \\ a_2 & a_3 & a_4 \\ a_2^2 & a_3^2 & a_4^2 \end{vmatrix} \\ = (a_2 - a_1)(a_3 - a_1)(a_4 - a_1)(a_3 - a_2)(a_4 - a_2)(a_4 - a_3)$$

$$37. (a) D_n = \begin{vmatrix} 1 & 1 & 1 & \dots & 1 \\ a_1 & a_2 & a_3 & \dots & a_n \\ a_1^2 & a_2^2 & a_3^2 & \dots & a_n^2 \\ \vdots & \vdots & \vdots & \ddots & \vdots \\ a_1^{n-1} & a_2^{n-1} & a_3^{n-1} & \dots & a_n^{n-1} \end{vmatrix} \quad (b) \text{ Use induction on } n. \text{ For the case } n = 2, D_2 = a_2 - a_1.$$

Suppose $D_{n-1} = \prod_{\substack{i=1 \\ j>i}}^{n-1} (a_j - a_i)$.

$$\text{Then } D_n = \begin{vmatrix} 1 & 1 & 1 & \dots & 1 \\ 0 & a_2 - a_1 & a_3 - a_1 & \dots & a_n - a_1 \\ 0 & a_2^2 - a_1a_2 & a_3^2 - a_1a_3 & \dots & a_n^2 - a_1a_n \\ \vdots & \vdots & \vdots & \ddots & \vdots \\ 0 & a_2^{n-1} - a_1a_2^{n-2} & a_3^{n-1} - a_1a_3^{n-2} & \dots & a_n^{n-1} - a_1a_n^{n-2} \end{vmatrix} = (a_2 - a_1)(a_3 - a_1) \dots (a_n - a_1)$$

$$(a_1) \begin{vmatrix} 1 & 1 & 1 & \dots & 1 \\ a_2 & a_3 & a_4 & \dots & a_n \\ a_2^2 & a_3^2 & a_4^2 & \dots & a_n^2 \\ \vdots & \vdots & \vdots & \ddots & \vdots \\ a_2^{n-2} & a_3^{n-2} & a_4^{n-2} & \dots & a_n^{n-2} \end{vmatrix} = (a_2 - a_1)(a_3 - a_1) \dots (a_n - a_1) \prod_{\substack{i=2 \\ j>i}}^n (a_j - a_i) = \prod_{\substack{i=1 \\ j>i}}^n (a_j - a_i).$$

38. (a) $AB = \begin{pmatrix} a_{11}b_{11} + a_{12}b_{21} & a_{11}b_{12} + a_{12}b_{22} \\ a_{21}b_{11} + a_{22}b_{21} & a_{21}b_{12} + a_{22}b_{22} \end{pmatrix}$

(b) $\det A = a_{11}a_{22} - a_{12}a_{21}$
 $\det B = b_{11}b_{22} - b_{12}b_{21}$
 $\det AB = (a_{11}b_{11} + a_{12}b_{21})(a_{21}b_{12} + a_{22}b_{22}) - a_{21}b_{11} + a_{22}b_{21})(a_{11}b_{12} + a_{12}b_{22})$

(c) $(\det A)(\det B) - a_{11}a_{22}b_{11}b_{22} - a_{11}a_{22}b_{12}b_{21} - a_{12}a_{21}b_{11}b_{22} + a_{12}a_{21}b_{12}b_{21} = \det AB$

39. (a) $\begin{pmatrix} 0 & 2 \\ 0 & 0 \end{pmatrix}^2 = 0$ and 2 is the smallest power.

(b) $\begin{pmatrix} 0 & 1 & 3 \\ 0 & 0 & 4 \\ 0 & 0 & 0 \end{pmatrix}^3 = 0$ and 3 is the smallest power: $\begin{pmatrix} 0 & 1 & 3 \\ 0 & 0 & 4 \\ 0 & 0 & 0 \end{pmatrix}^2 = \begin{pmatrix} 0 & 0 & 4 \\ 0 & 0 & 0 \\ 0 & 0 & 0 \end{pmatrix} \neq 0$.

40. $A^k = 0$ for some integer k . Then by theorem 4, $\det A^k = (\det A)^k = 0$. It follows that $\det A = 0$.

41. By theorem 4 we have $\det A = \det A^2 - (\det A)^2$. If $\det A \neq 0$, then $\det A = 1$.

42. By the definition given in section 1.11 $P = P_n P_{n-1} \cdots P_2 P_1$, where each P_i is an elementary permutation matrix. Since each P_i is obtained by interchanging two rows of an identity matrix, we have, by property 4, $\det P_i = -\det(I) = -1$. By theorem 1 we have $\det P = \det(P_n P_{n-1} \cdots P_2 P_1) = \det(P_n) \det(P_{n-1}) \cdots \det(P_2) \det(P_1) = (-1)^n = \pm 1$. (1 if n is even and -1 if n is odd).

43. Let Q be an elementary permutation matrix so Q is obtained by interchanging two rows, rows i and j of I . The j th row of I has a 1 in the j th column so the i th row of Q has a 1 in the j th column. That is, $Q_{ij} = 1$. Similarly, $Q_{ji} = 1$. Thus $Q_{ij} = Q_{ji}$. The only other nonzero components of Q are 1's on the diagonal and diagonal components stay put when the transpose is taken. Thus $Q^t = Q$. Now, if P is a permutation matrix, then

$$P = P_n P_{n-1} \cdots P_2 P_1$$

where each P_i is an elementary permutation matrix. Then, by Theorem 1

$$\det P = \det P_n \det P_{n-1} \cdots \det P_2 \det P_1 = (-1)^n$$

by the result of Problem 42. Also, by Theorem 1.9.1(ii),

$$\begin{aligned} P^t &= P_1^t P_2^t \cdots P_{n-1}^t P_n^t \\ &= P_1 P_2 \cdots P_{n-1} P_n \end{aligned}$$

Thus, P^t is a permutation matrix and, as above,

$$\det P^t = (-1)^n = \det P.$$

MATLAB 2.2

1. (a)

```

>> n = 2;
>> A = round( 10*(2*rand(n)-1))
A =
    -6     4
    -9     4

>> det(A)
ans =
    12

>> det(2*A)
ans =
    48

>> n = 3;
>> A = round( 10*(2*rand(n)-1))
A =
     9     7     1
    -2    -9     3
     0    -9   -10

>> det(A)
ans =
    931

>> det(2*A)
ans =
   7448

>> n = 4;
>> A = round( 10*(2*rand(n)-1))
A =
    -2     2    -8     8
    -9     9     3     5
    -2     7    -2    -5
     4     1     4    -9

>> det(A)
ans =
   2220

>> det(2*A)
ans =
  35520

```

(b) In each of the examples above, $\det(2A) = 2^n * \det(A)$. For a general k , $\det(kA) = k^n \det(A)$.

(c)

```

>> n = 2;
>> A = round( 10*(2*rand(n)-1));
>> det(3*A)/det(A)
ans =
     9
>> n = 3;
>> A = round( 10*(2*rand(n)-1));
>> det(3*A)/det(A)
ans =
    27
>> n = 4;
>> A = round( 10*(2*rand(n)-1));
>> det(3*A)/det(A)
ans =
    81

```

Each of these examples agrees with the conjecture in (b).

(d) Proof: For any k , $kA = kIA = (kI)A$. Using this, we have $\det(kA) = \det(kI)\det(A)$, so that all we need to show is that $\det(kI) = k^n$. But kI is a diagonal matrix with k 's on the diagonal, so that $\det(kI)$ is the product $k \cdot k \cdot k \cdot k \cdots k = k^n$.

2. (a)

```

>> A = [6 1 2 3; -1 4 1 1; 0 1 -3 1; 1 1 2 5];
>> det(A)
ans =
   -371

>> c = A(2,1)/A(1,1); A(2,:) = A(2,:) - c*A(1,:); % Eliminate A(2,1).
>> c = A(4,1)/A(1,1); A(4,:) = A(4,:) - c*A(1,:) % Eliminate A(4,1).
A =
    6.0000    1.0000    2.0000    3.0000
     0    4.1667    1.3333    1.5000
     0    1.0000   -3.0000    1.0000
     0    0.8333    1.6667    4.5000

>> c = A(3,2)/A(2,2); A(3,:) = A(3,:) - c*A(2,:); % Eliminate A(3,2).
>> c = A(4,2)/A(2,2); A(4,:) = A(4,:) - c*A(2,:) % Eliminate A(4,2).
A =
    6.0000    1.0000    2.0000    3.0000
     0    4.1667    1.3333    1.5000
     0     0   -3.3200    0.6400
     0     0    1.4000    4.2000

>> c = A(4,3)/A(3,3); A(4,:) = A(4,:) - c*A(3,:) % Eliminate A(4,3).
A =
    6.0000    1.0000    2.0000    3.0000
     0    4.1667    1.3333    1.5000
     0     0   -3.3200    0.6400
     0     0     0    4.4699

>> det(A)
ans =
   -371

```

There were no row interchanges, and $\det(A)$ was unchanged.

(b)

```
>> A = [ 0 1 2; 3 4 5; 1 2 3];
>> det(A)
ans =
    0

>> A([1 3],:) = A([3 1], :)    % The first row interchange.
A =
    1    2    3
    3    4    5
    0    1    2

>> c = A(2,1)/A(1,1); A(2,:) = A(2,:) - c*A(1,:) % Eliminate A(2,1).
A =
    1    2    3
    0   -2   -4
    0    1    2

>> c = A(3,2)/A(2,2); A(3,:) = A(3,:) - c*A(2,:) % Eliminate A(3,2).
A =
    1    2    3
    0   -2   -4
    0    0    0

>> det(A)
ans =
    0
```

There was one interchange, so $k = 1$ and $(-1)^k = -1$. Since $0 = -1 \cdot 0$, we have $\det(A) = (-1)^k \det(U)$.

(c)

```
>> A = [1 2 3; 4 5 6; -2 1 4];
>> det(A)
ans =
    0

>> A([1 2],:) = A([2 1],:)    % First interchange.
A =
    4    5    6
    1    2    3
   -2    1    4

>> c = A(2,1)/A(1,1); A(2,:) = A(2,:) - c*A(1,:); % Eliminate A(2,1).
>> c = A(3,1)/A(1,1); A(3,:) = A(3,:) - c*A(1,:) % Eliminate A(3,1).
A =
    4.0000    5.0000    6.0000
         0    0.7500    1.5000
         0    3.5000    7.0000

>> A([2 3],:) = A([3 2],:)    % Second interchange.
A =
    4.0000    5.0000    6.0000
         0    3.5000    7.0000
         0    0.7500    1.5000
```

```

>> c = A(3,2)/A(2,2); A(3,:) = A(3,:) - c*A(2,:) % Eliminate A(3,2).
A =
    4.0000    5.0000    6.0000
         0    3.5000    7.0000
         0         0         0

>> det(A)
ans =
     0

```

There were two interchanges, so $(-1)^k = +1$. Again, $0 = 1 \cdot 0$.

(d)

```

>> A = round( 10*(2*(rand(4) -1)) )
A =
   -14   -18   -12   -11
     0    -1   -14    -1
   -10   -19    -2   -19
   -15   -10    -9    -5

>> [L,U,P] = lu(A)
L =
    1.0000         0         0         0
    0.6667    1.0000         0         0
         0    0.0811    1.0000         0
    0.9333    0.7027    0.4475    1.0000

U =
  -15.0000  -10.0000  -9.0000  -5.0000
         0  -12.3333    4.0000 -15.6667
         0         0 -14.3243    0.2703
         0         0         0    4.5547

P =
     0     0     0     1
     0     0     1     0
     0     1     0     0
     1     0     0     0

>> det(A)
ans =
   -12070

>> det(U)
ans =
  -1.2070e+04

>> det(P)
ans =
     1

```

The matrix P represents the swapping the first row with the fourth, and the second with the third. Since this is two interchanges, $k = 2$, and $(-1)^k = 1$. Thus, $\det(A) = \det(U)$. The determinant of P is exactly the same as $(-1)^k$.

Section 2.3

1. Note that EB is matrix B with the i^{th} and j^{th} rows switched. Then $\det EB = -\det B$. But, $\det E = -1$. Thus, $\det EB = \det E \cdot \det B$.
2. Note that EB is the matrix B with row j replaced with row j plus c times row i . Then $\det EB = \det B$. But, $\det E = 1$. Thus, $\det EB = \det E \cdot \det B$.
3. Note that EB is the matrix B with row j replaced with c times row j . Then $\det EB = c \cdot \det B$. But, $\det E = c$. Thus, $\det EB = \det E \cdot \det B$.

Section 2.4

$$1. \det A = 4 \quad \text{adj } A = \begin{pmatrix} 2 & -2 \\ -1 & 3 \end{pmatrix} \quad A^{-1} = \begin{pmatrix} 1/2 & -1/2 \\ -1/4 & 3/4 \end{pmatrix}$$

2. $\det A = 0$; A is not invertible

$$3. \det A = -1 \quad \text{adj } A = \begin{pmatrix} 0 & -1 \\ -1 & 0 \end{pmatrix} \quad A^{-1} = \begin{pmatrix} 0 & 1 \\ 1 & 0 \end{pmatrix}$$

$$4. \det A = -8 \quad \text{adj } A = \begin{pmatrix} -13 & 4 & 1 \\ 15 & 4 & -3 \\ -10 & 0 & 2 \end{pmatrix} \quad A^{-1} = \begin{pmatrix} 13/8 & -1/2 & -1/8 \\ -15/8 & 1/2 & 3/8 \\ 5/4 & 0 & -1/4 \end{pmatrix}$$

$$5. \det A = -12 \quad \text{adj } A = \begin{pmatrix} -4 & 3 & 2 \\ 0 & -3 & -6 \\ 0 & -3 & 6 \end{pmatrix} \quad A^{-1} = \begin{pmatrix} 1/3 & -1/4 & -1/6 \\ 0 & 1/4 & 1/2 \\ 0 & 1/4 & -1/2 \end{pmatrix}$$

$$6. \det A = 1 \quad \text{adj } A = \begin{pmatrix} 1 & -1 & 0 \\ 0 & 1 & -1 \\ 0 & 0 & 1 \end{pmatrix} = A^{-1}$$

$$7. \det A = -1 \quad \text{adj } A = \begin{pmatrix} 0 & -1 & 1 \\ -2 & 2 & 1 \\ 1 & -1 & -1 \end{pmatrix} \quad A^{-1} = \begin{pmatrix} 0 & 1 & -1 \\ 2 & -2 & -1 \\ -1 & 1 & 1 \end{pmatrix}$$

$$8. \det A = -8 \quad \text{adj } A = \begin{pmatrix} -3 & -1 & 2 \\ 1 & 3 & -6 \\ 2 & -2 & -4 \end{pmatrix} \quad A^{-1} = \begin{pmatrix} 3/8 & 1/8 & -1/4 \\ -1/8 & -3/8 & 3/4 \\ -1/4 & 1/4 & 1/2 \end{pmatrix}$$

9. $\det A = 0$; A is not invertible 10. $\det A = 0$; A is not invertible

$$11. \det A = -9 \quad \text{adj } A = \begin{pmatrix} -21 & 3 & 3 & 6 \\ -4 & 1 & 4 & -1 \\ 1 & 2 & -1 & -2 \\ 15 & -6 & -6 & -3 \end{pmatrix} \quad A^{-1} = \begin{pmatrix} 7/3 & -1/3 & -1/3 & -2/3 \\ 4/9 & -1/9 & -4/9 & 1/9 \\ -1/9 & -2/9 & 1/9 & 2/9 \\ -5/3 & 2/3 & 2/3 & 1/3 \end{pmatrix}$$

$$12. \det A = -1 \quad \text{adj } A = \begin{pmatrix} 0 & -1 & 0 & -2 \\ -1 & 1 & 2 & -2 \\ 0 & -1 & -3 & 3 \\ 2 & -2 & -3 & 2 \end{pmatrix} \quad A^{-1} = \begin{pmatrix} 0 & 1 & 0 & 2 \\ 1 & -1 & -2 & 2 \\ 0 & 1 & 3 & -3 \\ -2 & 2 & 3 & -2 \end{pmatrix}$$

13. By theorem 2.2.3, $\det A = \det A^t$. Hence, $\det A$ is nonzero if and only if $\det A^t$ is nonzero. By theorem 4, A is invertible if and only if A^t is invertible.

$$14. \det A = 3 \quad A^{-1} = \frac{1}{3} \begin{pmatrix} 5 & -1 \\ -2 & 1 \end{pmatrix} \quad \det A^{-1} = 1/3$$

$$15. \det A = -28 \quad A^{-1} = -\frac{1}{28} \begin{pmatrix} -2 & -2 & -9 \\ 20 & -8 & 6 \\ -2 & -2 & 5 \end{pmatrix} \quad \det A^{-1} = -\frac{1}{28}$$

$$16. \begin{vmatrix} \alpha & -3 \\ 4 & 1 - \alpha \end{vmatrix} = \alpha - \alpha^2 + 12 = 0. \text{ If } \alpha = 4 \text{ or } -3 \text{ then the matrix is not invertible.}$$

$$17. \begin{vmatrix} -\alpha & \alpha - 1 & \alpha + 1 \\ 1 & 2 & 3 \\ 2 - \alpha & \alpha + 3 & \alpha + 7 \end{vmatrix} = \begin{vmatrix} 0 & 3\alpha - 1 & 4\alpha + 1 \\ 1 & 2 & 3 \\ 0 & 3\alpha - 1 & 4\alpha + 1 \end{vmatrix} = 0 \text{ (} R_1 = R_3 \text{)}. \text{ Hence, for all values of } \alpha, \text{ the matrix is not invertible.}$$

18. By theorem 2, $(A)(\text{adj } A) = (\det A)I$. By theorem 4, $\det A = 0$. It follows that $(A)(\text{adj } A)$ is the zero matrix.

19. Let $A = \begin{pmatrix} \cos \theta & \sin \theta \\ -\sin \theta & \cos \theta \end{pmatrix}$. $\det A = \cos^2 \theta + \sin^2 \theta = 1$. By theorem 3, this matrix is invertible.

$$A^{-1} = \frac{1}{\det A} \cdot \text{adj } A = 1 \cdot \begin{pmatrix} \cos \theta & -\sin \theta \\ \sin \theta & \cos \theta \end{pmatrix} = \begin{pmatrix} \cos \theta & -\sin \theta \\ \sin \theta & \cos \theta \end{pmatrix}.$$

MATLAB 2.4

1.

```
>> n = 5; m = 4;
>> A = 2*rand(n,m)-1;
>> det(A' * A)
ans =
    4.8868

>> n = 4; m = 5;
>> A = 2*rand(n,m)-1;
>> det(A' * A)
ans =
    4.8441e-17
```

When $n > m$, $\det(A^t A) > 0$. However, when $n < m$, $\det(A^t A) = 0$ up to roundoff error.

2.

```
>> A = round(10*(2*rand(4)-1))
A =
   -4     0     7    -3
   -9    -1     4    -9
    0    -7     2    10
   -1   -4     4     1
```

(a)

```
>> flops(0);
>> C = zeros(4);
>> C(1,1) = det(A([2 3 4], [2 3 4])); C(1,2) = -det(A([2 3 4], [1 3 4]));
>> C(1,3) = det(A([2 3 4], [1 2 4])); C(1,4) = -det(A([2 3 4], [1 2 3]));
>> C(2,1) = -det(A([1 3 4], [2 3 4])); C(2,2) = det(A([1 3 4], [1 3 4]));
>> C(2,3) = -det(A([1 3 4], [1 2 4])); C(2,4) = det(A([1 3 4], [1 2 3]));
>> C(3,1) = det(A([1 2 4], [2 3 4])); C(3,2) = -det(A([1 2 4], [1 3 4]));
>> C(3,3) = det(A([1 2 4], [1 2 4])); C(3,4) = -det(A([1 2 4], [1 2 3]));
>> C(4,1) = -det(A([1 2 3], [2 3 4])); C(4,2) = det(A([1 2 3], [1 3 4]));
>> C(4,3) = -det(A([1 2 3], [1 2 4])); C(4,4) = det(A([1 2 3], [1 2 3]));
>> C = C' % Don't forget the transpose.
```

```
C =
    86    171    223   -433
   -284     76    -62    452
   -224    111     43   -103
   -154     31   -197    337

>> s = flops
s =
    200
```

(b)

```
>> flops(0);
>> D = det(A)*inv(A)
D =
    86.0000    171.0000    223.0000   -433.0000
   -284.0000     76.0000   -62.0000    452.0000
   -224.0000    111.0000     43.0000   -103.0000
   -154.0000     31.0000   -197.0000    337.0000
```



```
>> ss = flops
ss =
    232
```

(c)

```
>> C-D
ans =
    1.0e-12 *
   -0.0568    0.0284    0.0284    0.0568
         0         0    0.0284   -0.0568
   -0.0284    0.0284   -0.0142    0.0142
    0.0568   -0.0071    0.0568   -0.1137
```

The matrix D is the same as C except for some small round off error. This is expected by equation (8).

(d) Method (a) uses fewer flops than method (b).

3.

```
>> C = 20 * [7 7 -7 2 5 6; 0 5 -10 4 8 6; 9 7 -5 3 4 0; ...
            5 7 -9 5 2 0; 5 2 1 9 10 8; 1 9 -17 4 2 7]
```

```
C =
   140   140  -140    40   100   120
     0   100  -200    80   160   120
   180   140  -100    60    80     0
   100   140  -180   100    40     0
   100    40    20   180   200   160
    20   180  -340    80    40   140
```

```
>> rref(C) % This has a zero row, so C is not invertible.
```

```
ans =
     1     0     1     0     0     0
     0     1    -2     0     0     0
     0     0     0     1     0     0
     0     0     0     0     1     0
     0     0     0     0     0     1
     0     0     0     0     0     0
```

```
>> A=C; A(3,3) = C(3,3) + 1.e-10;
>> rref(A) % This is invertible.
```

```
ans =
     1     0     0     0     0     0
     0     1     0     0     0     0
     0     0     1     0     0     0
     0     0     0     1     0     0
     0     0     0     0     1     0
     0     0     0     0     0     1
```

```
>> det(A)
ans =
    6.5509
```

The determinant of A is not very close to 0. This indicates that the “natural assumption” is false.

4. (a) One way to generate an upper triangular matrix with determinant 1 is to create a random matrix with zeros below the first diagonal, and to add the identity matrix to this. Type `help triu` for more information.

```
>> A = triu(round( 6*(2*rand(5)-1)),1) + eye(5);
>> det(A)
ans =
    1
>> A(4,:) = A(4,:) - 2*A(2,:); % Perform several row operations to A.
>> A(5,:) = A(5,:) + 2*A(3,:);
>> A(2,:) = A(2,:) + 3*A(1,:);
>> A(3,:) = A(3,:) - 4*A(1,:);
>> A(4,:) = A(4,:) +  A(1,:);
>> A(5,:) = A(5,:) - 3*A(1,:);
A =
```

```
    1    -2    -3    -5     3
    3    -5    -3   -13     9
   -4     8    13    25   -15
    1    -4   -15    -8     0
   -3     6    11    25   -14
```

(b)

```
>> det(A)
ans =
    1
```

We expect $\det(A) = 1$ since we started off with $\det(A) = 1$, and we only used elementary row operations whose determinants were 1. Since $\det(A)=1$ and all the \det 's used to form $\text{adj}(A)$ will be integers, $\text{inv}(A)=(1/1)*\text{adj}(A)$ should have integer entries.

- (c) MATLAB is able to convert between characters and numbers. Type `help strfun` for more information.

```
>> S = [ 'SMALL'; ' PLAS'; 'TIC T'; 'HING'S'; ' MOVE'; 'WHEN '; ...
        'YOU D'; 'ONT L'; 'OOK  '];
```

```
>> M = S - 'A' + 1 % Convert to numbers.
```

```
M =
    19    13     1    12    12
   -32    16    12     1    19
    20     9     3   -32    20
     8     9    14     7    19
   -32    13    15    22     5
    23     8     5    14   -32
    25    15    21   -32     4
    15    14    20   -32    12
    15    15    11   -32   -32
```

```
>> C = M*A % Encode the message.
```

```
C =
    30    -71   -131    -35     -9
   -88    190    398     719   -398
   -57    187    652     614   -184
   -71    137    235     612   -371
   -46     61    -23     315   -274
   137   -294   -590   -1006    514
   -58    195    677     561   -161
   -91    260    785     799   -297
     80    -81    181    -539    463
```

```
>> M2 = C* inv(A);           % The instructor should decode the message.
>> setstr(round(M2) + 'A' - 1) % setstr converts numbers to characters.
ans =
SMALL
  PLAS
TIC T
HINGS
  MOVE
WHEN
YOU D
ONT L
OOK
```

Section 2.5

$$1. x_1 = \frac{\begin{vmatrix} -1 & 3 \\ 47 & 4 \\ 2 & 3 \\ -7 & 4 \end{vmatrix}}{\begin{vmatrix} 2 & 3 \\ -7 & 4 \end{vmatrix}} = \frac{-4 - 141}{8 + 21} - \frac{-145}{29} = -5; \quad x_2 = \frac{\begin{vmatrix} 2 & -1 \\ -7 & 47 \end{vmatrix}}{29} = \frac{94 - 7}{29} = \frac{87}{29} = 3$$

$$2. x_1 = \frac{\begin{vmatrix} 0 & -1 \\ 5 & 2 \\ 3 & -1 \\ 4 & 2 \end{vmatrix}}{\begin{vmatrix} 3 & -1 \\ 4 & 2 \end{vmatrix}} = \frac{0 + 5}{6 + 4} = \frac{5}{10} = \frac{1}{2}; \quad x_2 = \frac{\begin{vmatrix} 3 & 4 \\ 4 & 5 \end{vmatrix}}{10} = \frac{15 - 0}{10} = \frac{15}{10} = \frac{3}{2}$$

$$3. x_1 = \frac{\begin{vmatrix} 6 & 1 & 1 \\ 5 & -2 & -3 \\ 11 & 2 & 5 \\ 2 & 1 & 1 \\ 3 & -2 & -3 \\ 8 & 2 & 5 \end{vmatrix}}{\begin{vmatrix} 2 & 1 & 1 \\ 3 & -2 & -3 \\ 8 & 2 & 5 \end{vmatrix}} = \frac{-50}{-25} = 2; \quad x_2 = \frac{\begin{vmatrix} 2 & 6 & 1 \\ 3 & 5 & -3 \\ 8 & 11 & 5 \end{vmatrix}}{-25} = \frac{-125}{-25} = 5; \quad x_3 = \frac{\begin{vmatrix} 2 & 1 & 6 \\ 3 & -2 & 5 \\ 8 & 2 & 11 \end{vmatrix}}{-25} = \frac{75}{-25} = -3$$

$$4. x_1 = \frac{\begin{vmatrix} 8 & 1 & 1 \\ -2 & 4 & -1 \\ 0 & -1 & 2 \\ 1 & 1 & 1 \\ 0 & 4 & -1 \\ 3 & -1 & 2 \end{vmatrix}}{\begin{vmatrix} 1 & 1 & 1 \\ 0 & 4 & -1 \\ 3 & -1 & 2 \end{vmatrix}} = \frac{62}{-8} = -\frac{31}{4}; \quad x_2 = \frac{\begin{vmatrix} 1 & 8 & 1 \\ 0 & -2 & -1 \\ 3 & 0 & 2 \end{vmatrix}}{-8} = \frac{-22}{-8} = \frac{11}{4}; \quad x_3 = \frac{\begin{vmatrix} 1 & 1 & 8 \\ 0 & 4 & -2 \\ 3 & -1 & 0 \end{vmatrix}}{-8} = 13$$

$$5. x_1 = \frac{\begin{vmatrix} 7 & 2 & 1 \\ 0 & 2 & -1 \\ 1 & 1 & 3 \\ 2 & 2 & 1 \\ 1 & 2 & -1 \\ -1 & 1 & 3 \end{vmatrix}}{\begin{vmatrix} 2 & 2 & 1 \\ 1 & 2 & -1 \\ -1 & 1 & 3 \end{vmatrix}} = \frac{45}{13}; \quad x_2 = \frac{\begin{vmatrix} 2 & 7 & 1 \\ 1 & 0 & -1 \\ -1 & 1 & 3 \end{vmatrix}}{13} = \frac{-11}{13}; \quad x_3 = \frac{\begin{vmatrix} 2 & 2 & 7 \\ 1 & 2 & 0 \\ -1 & 1 & 1 \end{vmatrix}}{13} = \frac{23}{13}$$

$$6. x_1 = \frac{\begin{vmatrix} -1 & 5 & -1 \\ 3 & 1 & 3 \\ 0 & 2 & 0 \\ 2 & 5 & -1 \\ 4 & 1 & 3 \\ -2 & 2 & 0 \end{vmatrix}}{\begin{vmatrix} 2 & 5 & -1 \\ 4 & 1 & 3 \\ -2 & 2 & 0 \end{vmatrix}} = \frac{0}{-52} = 0; \quad x_2 = \frac{\begin{vmatrix} 2 & -1 & -1 \\ 4 & 3 & 3 \\ -2 & 0 & 0 \end{vmatrix}}{-52} = \frac{0}{-52} = 0; \quad x_3 = \frac{\begin{vmatrix} 2 & 5 & -1 \\ 4 & 1 & 3 \\ -2 & 2 & 0 \end{vmatrix}}{-52} = \frac{-52}{-52} = 1$$

$$7. x_1 = \frac{\begin{vmatrix} 4 & 1 & -1 \\ 2 & 0 & 1 \\ 1 & -1 & 5 \\ 2 & 1 & -1 \\ 1 & 0 & 1 \\ 0 & -1 & 5 \end{vmatrix}}{\begin{vmatrix} 2 & 1 & -1 \\ 1 & 0 & 1 \\ 0 & -1 & 5 \end{vmatrix}} = \frac{-3}{-2} = \frac{3}{2}; \quad x_2 = \frac{\begin{vmatrix} 2 & 4 & -1 \\ 1 & 2 & 1 \\ 0 & 1 & 5 \end{vmatrix}}{-2} = \frac{-3}{-2} = \frac{3}{2}; \quad x_3 = \frac{\begin{vmatrix} 2 & 1 & 4 \\ 1 & 0 & 2 \\ 0 & -1 & 1 \end{vmatrix}}{-2} = \frac{-1}{-2} = \frac{1}{2}$$

$$8. x_1 = \frac{\begin{vmatrix} 6 & 1 & 1 & 1 \\ 4 & 0 & -1 & -1 \\ 3 & 0 & 3 & 6 \\ 5 & 0 & 0 & -1 \\ 1 & 1 & 1 & 1 \\ 2 & 0 & -1 & -1 \\ 0 & 0 & 3 & 6 \\ 1 & 0 & 0 & -1 \end{vmatrix}}{\begin{vmatrix} 1 & 1 & 1 & 1 \\ 2 & 0 & -1 & -1 \\ 0 & 0 & 3 & 6 \\ 1 & 0 & 0 & -1 \end{vmatrix}} = \frac{30}{9} = \frac{10}{3}; \quad x_2 = \frac{\begin{vmatrix} 1 & 6 & 1 & 1 \\ 2 & 4 & -1 & -1 \\ 0 & 3 & 3 & 6 \\ 1 & 5 & 0 & -1 \end{vmatrix}}{9} = \frac{0}{9} = 0;$$

$$x_3 = \frac{\begin{vmatrix} 1 & 1 & 6 & 1 \\ 2 & 0 & 4 & -1 \\ 0 & 0 & 3 & 6 \\ 1 & 0 & 5 & -1 \end{vmatrix}}{9} = \frac{39}{9} = \frac{13}{3}; \quad x_4 = \frac{\begin{vmatrix} 1 & 1 & 1 & 6 \\ 2 & 0 & -1 & 4 \\ 0 & 0 & 3 & 3 \\ 1 & 0 & 0 & 5 \end{vmatrix}}{9} = \frac{-15}{9} = \frac{-5}{3}$$

$$9. \quad x_1 = \frac{\begin{vmatrix} 7 & 0 & 0 & -1 \\ 2 & 2 & 1 & 0 \\ -3 & -1 & 0 & 0 \\ 2 & 0 & 3 & -5 \end{vmatrix}}{\begin{vmatrix} 1 & 0 & 0 & -1 \\ 0 & 2 & 1 & 0 \\ 4 & -1 & 0 & 0 \\ 0 & 0 & 3 & -5 \end{vmatrix}} = \frac{-21}{-29} = \frac{21}{29}; \quad x_2 = \frac{\begin{vmatrix} 1 & 7 & 0 & -1 \\ 0 & 2 & 1 & 0 \\ 4 & -3 & 0 & 0 \\ 0 & 2 & 3 & -5 \end{vmatrix}}{-29} = \frac{-171}{-29} = \frac{171}{29};$$

$$x_3 = \frac{\begin{vmatrix} 1 & 0 & 7 & -1 \\ 0 & 2 & 2 & 0 \\ 4 & -1 & -3 & 0 \\ 0 & 0 & 2 & -5 \end{vmatrix}}{-29} = \frac{284}{-29} = \frac{-284}{29}; \quad x_4 = \frac{\begin{vmatrix} 1 & 0 & 0 & 7 \\ 0 & 2 & 1 & 2 \\ 4 & -1 & 0 & -3 \\ 0 & 0 & 3 & 2 \end{vmatrix}}{-29} = \frac{182}{-29} = \frac{-182}{29}$$

10. (a) From Figure 2.2, it is easy to see that $b \cdot \cos A + a \cdot \cos B = c$. Similarly, if we insert the perpendicular from the vertex at angle A to the opposite side and insert the perpendicular from the vertex of angle B to the opposite side, then we obtain $c \cdot \cos A + a \cdot \cos C = b$ and $c \cdot \cos B + b \cdot \cos C = a$.

$$(b) \quad \begin{vmatrix} c & 0 & a \\ b & a & 0 \\ 0 & c & b \end{vmatrix} = abc + abc = 2abc \neq 0$$

$$(c) \quad \cos C = \frac{\begin{vmatrix} c & 0 & b \\ b & a & c \\ 0 & c & a \end{vmatrix}}{2abc} = \frac{a^2c + b^2c - c^3}{2bac} = \frac{a^2 + b^2 - c^2}{2ab}$$

$$(d) \quad 2ab \cdot \cos C = a^2 + b^2 - c^2, \text{ or } c^2 = a^2 + b^2 - 2ab \cdot \cos C$$

MATLAB 2.5

1.

```
>> A = 2*rand(5)-1
A =
    0.2591    -0.5336     0.6920     0.0746     0.1433
    0.4724    -0.3874    -0.1758    -0.0642     0.6048
    0.4508    -0.2980     0.6830    -0.4256    -0.9339
    0.9989     0.0265    -0.4614    -0.6433     0.0689
    0.7771     0.1822    -0.1692    -0.6926    -0.0030
```

```
>> b = 2*rand(5,1)-1
b =
    0.9107
    0.4966
    0.1092
    0.7815
    0.2497
```

(a)

```
>> flops(0);
>> d = det(A)
d =
    0.0387

>> x = zeros(5,1);
>> C = A; C(:,1) = b; x(1) = det(C);
>> C = A; C(:,2) = b; x(2) = det(C);
>> C = A; C(:,3) = b; x(3) = det(C);
>> C = A; C(:,4) = b; x(4) = det(C);
>> C = A; C(:,5) = b; x(5) = det(C);
>> x = x / d           % Divide each element in x by d.

x =
    4.4245
    2.4047
    1.0314
    4.9862
   -0.2662

>> s = flops
s =
    425
```

(b)

```
>> flops(0);
>> z = A\b
z =
    4.4245
    2.4047
    1.0314
    4.9862
   -0.2662
```

```
>> ss = flops
ss =
    266
```

(c)

```
>> format short e
>> x-z
ans =
-2.6645e-15
         0
-2.2204e-16
-1.7764e-15
         0
```

The two solutions are very close to each other. The number of flops was almost twice as much for Cramer's rule as for the built-in method.

- (d) For a 7×7 matrix, Cramer's rule takes about 1680 flops versus about 600 for the built-in method. It appears $A \setminus \mathbf{b}$ becomes more efficient as the size of the system increases. (In fact the built-in method takes about $(2/3)n^3$ flops for large N , while Cramer's rule, using the (efficient) built-in method for \det takes about $(2/3)n^4$ flops for large n .)

Review Exercises for Chapter 2

$$1. \begin{vmatrix} -1 & 2 \\ 0 & 4 \end{vmatrix} = -4 - 0 = -4 \quad 2. \begin{vmatrix} -3 & 5 \\ -7 & 4 \end{vmatrix} = -12 + 35 = 23$$

$$3. \begin{vmatrix} 1 & -2 & 3 \\ 0 & 4 & 5 \\ 0 & 0 & 6 \end{vmatrix} = (1)(4)(6) = 24 \quad 4. \begin{vmatrix} 5 & 0 & 0 \\ 6 & 2 & 0 \\ 10 & 10 & 6 \end{vmatrix} = (5)(2)(6) = 60$$

$$5. \begin{vmatrix} 1 & -1 & 2 \\ 3 & 4 & 2 \\ -2 & 3 & 4 \end{vmatrix} = 16 + 4 + 18 + 16 + 12 - 6 = 60$$

$$6. \begin{vmatrix} 3 & 1 & -2 \\ 4 & 0 & 5 \\ -6 & 1 & 3 \end{vmatrix} = -30 - 8 - 12 - 15 = -65$$

$$7. \begin{vmatrix} 1 & -1 & 2 & 3 \\ 4 & 0 & 2 & 5 \\ -1 & 2 & 3 & 7 \\ 5 & 1 & 0 & 4 \end{vmatrix} = -4 \begin{vmatrix} -1 & 2 & 3 \\ 2 & 3 & 7 \\ 1 & 0 & 4 \end{vmatrix} - 2 \begin{vmatrix} 1 & -1 & 3 \\ -1 & 2 & 7 \\ 5 & 1 & 4 \end{vmatrix} + 5 \begin{vmatrix} 1 & -1 & 2 \\ -1 & 2 & 3 \\ 5 & 1 & 0 \end{vmatrix} \\ = -4(23) - 2(-17) + 5(-40) = 92 + 142 - 200 = 34$$

$$8. \begin{vmatrix} 3 & 15 & 17 & 19 \\ 0 & 2 & 21 & 60 \\ 0 & 0 & 1 & 50 \\ 0 & 0 & 0 & -1 \end{vmatrix} = (3)(2)(1)(-1) = -6$$

$$9. \begin{vmatrix} -3 & 4 \\ 2 & 1 \end{vmatrix} = -2 - 8 = -11; A_{11} = 1; A_{12} = -2; A_{21} = -4; A_{22} = -3; A^{-1} = \frac{1}{-11} \begin{pmatrix} 1 & -4 \\ -2 & -3 \end{pmatrix}$$

$$10. \begin{vmatrix} 3 & -5 & 7 \\ 0 & 2 & 4 \\ 0 & 0 & -3 \end{vmatrix} = (3)(2)(-3) = -18; A_{11} = -6; A_{12} = 0; A_{13} = 0; A_{21} = -15; A_{22} = -9; A_{23} = 0;$$

$$A_{31} = -34; A_{32} = -12; A_{33} = 6; A^{-1} = -\frac{1}{18} \begin{pmatrix} -6 & -15 & -34 \\ 0 & -9 & -12 \\ 0 & 0 & 6 \end{pmatrix}$$

$$11. \begin{vmatrix} 1 & -1 & 2 \\ 3 & 1 & 4 \\ 5 & -1 & 8 \end{vmatrix} = 8 - 20 - 6 - 10 + 24 + 4 = 0. \text{ No inverse.}$$

$$12. \begin{vmatrix} 1 & 1 & 1 \\ 1 & 0 & 1 \\ 0 & 1 & 1 \end{vmatrix} = 1 - 1 - 1 = -1; A_{11} = -1; A_{12} = -1; A_{13} = 1; A_{21} = 0; A_{22} = 1; A_{23} = -1; A_{31} = 1;$$

$$A_{32} = 0; A_{33} = -1; A^{-1} = -1 \begin{pmatrix} -1 & 0 & 1 \\ -1 & 1 & 0 \\ 1 & -1 & -1 \end{pmatrix} = \begin{pmatrix} 1 & 0 & -1 \\ 1 & -1 & 0 \\ -1 & 1 & 1 \end{pmatrix}$$

$$13. \begin{vmatrix} 2 & 1 & 0 & 0 \\ 0 & -1 & 3 & 0 \\ 1 & 0 & 0 & -2 \\ 3 & 0 & -1 & 0 \end{vmatrix} = 2 \begin{vmatrix} -1 & 3 & 0 \\ 0 & 0 & -2 \\ 0 & -1 & 0 \end{vmatrix} - 1 \begin{vmatrix} 0 & 3 & 0 \\ 1 & 0 & -2 \\ 3 & -1 & 0 \end{vmatrix} = 2(2) - 1(-18) = 22$$

$$A_{11} = 2; A_{12} = 18; A_{13} = 6; A_{14} = 1; A_{21} = 2; A_{22} = -4; A_{23} = 6; A_{24} = 1; A_{31} = 0; A_{32} = 0;$$

$$A_{33} = 0; A_{34} = -11; A_{41} = 6; A_{42} = -12; A_{43} = -4; A_{44} = 3; A^{-1} = \frac{1}{22} \begin{pmatrix} 2 & 2 & 0 & 6 \\ 18 & -4 & 0 & -12 \\ 6 & 6 & 0 & -4 \\ 1 & 1 & -11 & 3 \end{pmatrix}$$

$$14. \begin{vmatrix} 3 & -1 & 2 & 4 \\ 1 & 1 & 0 & 3 \\ -2 & 4 & 1 & 5 \\ 6 & -4 & 1 & 2 \end{vmatrix} = -1 \begin{vmatrix} -1 & 2 & 4 \\ 4 & 1 & 5 \\ -4 & 1 & 2 \end{vmatrix} + \begin{vmatrix} 3 & 2 & 4 \\ -2 & 1 & 5 \\ 6 & 1 & 2 \end{vmatrix} + 3 \begin{vmatrix} 3 & -1 & 2 \\ -2 & 4 & 1 \\ 6 & -4 & 1 \end{vmatrix}$$

$$= 21 + 27 - 48 = 0; \text{ No inverse.}$$

$$15. x_1 = \frac{\begin{vmatrix} 3 & -1 \\ 5 & 2 \\ 2 & -1 \\ 3 & 2 \end{vmatrix}}{7} = \frac{11}{7}; \quad x_2 = \frac{\begin{vmatrix} 2 & 3 \\ 3 & 5 \\ 2 & -1 \\ 3 & 2 \end{vmatrix}}{7} = \frac{1}{7}$$

$$16. x_1 = \frac{\begin{vmatrix} 7 & -1 & 1 \\ 4 & 0 & -5 \\ 2 & 3 & -1 \\ 1 & -1 & 1 \\ 2 & 0 & -5 \\ 0 & 3 & -1 \end{vmatrix}}{19} = \frac{123}{19}; \quad x_2 = \frac{\begin{vmatrix} 1 & 7 & 1 \\ 2 & 4 & -5 \\ 0 & 2 & -1 \end{vmatrix}}{19} = \frac{24}{19}; \quad x_3 = \frac{\begin{vmatrix} 1 & -1 & 7 \\ 2 & 0 & 4 \\ 0 & 3 & 2 \end{vmatrix}}{19} = \frac{34}{19}$$

$$17. x_1 = \frac{\begin{vmatrix} 5 & 3 & -1 \\ 0 & 2 & 3 \\ -1 & -1 & 1 \\ 2 & 3 & -1 \\ -1 & 2 & 3 \\ 4 & -1 & 1 \end{vmatrix}}{56} = \frac{14}{56} = \frac{1}{4}; \quad x_2 = \frac{\begin{vmatrix} 2 & 5 & -1 \\ -1 & 0 & 3 \\ 4 & -1 & 1 \end{vmatrix}}{56} = \frac{70}{56} = \frac{5}{4};$$

$$x_3 = \frac{\begin{vmatrix} 2 & 3 & 5 \\ -1 & 2 & 0 \\ 4 & -1 & -1 \end{vmatrix}}{56} = \frac{-42}{56} = \frac{-3}{4}$$

$$18. x_1 = \frac{\begin{vmatrix} 7 & 0 & -1 & 1 \\ -1 & 2 & 2 & -3 \\ 0 & -1 & -1 & 0 \\ 2 & 1 & 4 & 0 \\ 1 & 0 & -1 & 1 \\ 0 & 2 & 2 & -3 \\ 4 & -1 & -1 & 0 \\ -2 & 1 & 4 & 0 \end{vmatrix}}{39} = \frac{66}{39} = \frac{22}{13}; \quad x_2 = \frac{\begin{vmatrix} 1 & 7 & -1 & 1 \\ 0 & -1 & 2 & -3 \\ 4 & 0 & -1 & 0 \\ -2 & 2 & 4 & 0 \end{vmatrix}}{39} = \frac{282}{39} = \frac{94}{13};$$

$$x_3 = \frac{\begin{vmatrix} 1 & 0 & 7 & 1 \\ 0 & 2 & -1 & -3 \\ 4 & -1 & 0 & 0 \\ -2 & 1 & 2 & 0 \end{vmatrix}}{39} = \frac{-18}{39} = \frac{-6}{13}; \quad x_4 = \frac{\begin{vmatrix} 1 & 0 & -1 & 7 \\ 0 & 2 & 2 & -1 \\ 4 & -1 & -1 & 0 \\ -2 & 1 & 4 & 2 \end{vmatrix}}{39} = \frac{189}{39} = \frac{63}{13}$$

Chapter 3. Vectors in \mathbb{R}^2 and \mathbb{R}^3
Section 3.1

Note $\tan^{-1} y/x$ is always between $-\pi/2$ and $\pi/2$. To get θ between 0 and 2π will require adding π or 2π for some (x, y) pairs.

1. $|\mathbf{v}| = \sqrt{4^2 + 4^2} = 4\sqrt{2}$ $\theta = \tan^{-1} 1 = \frac{\pi}{4}$
2. $|\mathbf{v}| = \sqrt{(-4)^2 + 4^2} = 4\sqrt{2}$ $\theta = \pi + \tan^{-1}(-1) = \frac{3\pi}{4}$ (π added as in 2nd quadrant.)
3. $|\mathbf{v}| = \sqrt{4^2 + (-4)^2} = 4\sqrt{2}$ $\theta = 2\pi + \tan^{-1}(-1) = \frac{7\pi}{4}$ (2π added for 4th quadrant.)
4. $|\mathbf{v}| = \sqrt{(-4)^2 + (-4)^2} = 4\sqrt{2}$ $\theta = \pi + \tan^{-1} 1 = \frac{5\pi}{4}$ (π added for 3rd quadrant.)
5. $|\mathbf{v}| = \sqrt{(\sqrt{3})^2 + 1^2} = 2$ $\theta = \tan^{-1} 1/\sqrt{3} = \frac{\pi}{6}$
6. $|\mathbf{v}| = \sqrt{1^2 + (\sqrt{3})^2} = 2$ $\theta = \tan^{-1} \sqrt{3} = \frac{\pi}{3}$
7. $|\mathbf{v}| = \sqrt{(-1)^2 + (\sqrt{3})^2} = 2$ $\theta = \pi + \tan^{-1}(-\sqrt{3}) = \frac{2\pi}{3}$ (2nd quadrant)
8. $|\mathbf{v}| = \sqrt{1^2 + (-\sqrt{3})^2} = 2$ $\theta = 2\pi + \tan^{-1}(-\sqrt{3}) = \frac{5\pi}{3}$ (4th quadrant)
9. $|\mathbf{v}| = \sqrt{(-1)^2 + (-\sqrt{3})^2} = 2$ $\theta = \pi + \tan^{-1} \sqrt{3} = \frac{4\pi}{3}$ (3rd quadrant)
10. $|\mathbf{v}| = \sqrt{1^2 + 2^2} = \sqrt{5}$ $\theta = \tan^{-1} 2 \approx 1.1071$
11. $|\mathbf{v}| = \sqrt{(-5)^2 + 8^2} = \sqrt{89}$ $\theta = \pi + \tan^{-1}(-8/5) \approx 2.1294$ (2nd quadrant)
12. $|\mathbf{v}| = \sqrt{11^2 + (-14)^2} = \sqrt{317}$ $\theta = 2\pi + \tan^{-1}(-14/11) \approx 5.3784$ (4th quadrant)
13. (a) (6, 9) (b) (-3, 7) (c) (-7, 1) (d) (39, -22)
14. (a) $-2\mathbf{i} + 3\mathbf{j}$ (b) $6\mathbf{i} - 9\mathbf{j}$ (c) $6\mathbf{i} - 9\mathbf{j}$ (d) $28\mathbf{i} - 42\mathbf{j}$ (e) $28\mathbf{i} - 42\mathbf{j}$ (f) $-28\mathbf{i} + 42\mathbf{j}$
15. $|\mathbf{i}| = |(1, 0)| = \sqrt{1^2 + 0^2} = 1$ $|\mathbf{j}| = \sqrt{0^2 + 1^2} = 1$
16. $|(1/\sqrt{2})\mathbf{i} + (1/\sqrt{2})\mathbf{j}| = \sqrt{(1/\sqrt{2})^2 + (1/\sqrt{2})^2} = 1$
17. $|\mathbf{u}| = \sqrt{a^2/(a^2 + b^2) + b^2/(a^2 + b^2)} = 1$. Since quadrant of \mathbf{u} , \mathbf{v} are the same, their directions will be the same since $\tan^{-1} \frac{\sqrt{a^2 + b^2}}{a} = \tan^{-1} \frac{b}{a}$.
18. $|\mathbf{v}| = \sqrt{13}$ $\mathbf{u} = \mathbf{v}/|\mathbf{v}| = (2/\sqrt{13})\mathbf{i} + (3/\sqrt{13})\mathbf{j}$
19. $|\mathbf{v}| = \sqrt{2}$ $\mathbf{u} = \mathbf{v}/|\mathbf{v}| = (1/\sqrt{2})\mathbf{i} - (1/\sqrt{2})\mathbf{j}$
20. $|\mathbf{v}| = 5$ $\mathbf{u} = \mathbf{v}/|\mathbf{v}| = (-3/5)\mathbf{i} + (4/5)\mathbf{j}$
21. $|\mathbf{v}| = a\sqrt{2}$ $\mathbf{u} = \mathbf{v}/|\mathbf{v}| = (1/\sqrt{2})\mathbf{i} + (1/\sqrt{2})\mathbf{j}$ if $a > 0$
 $\mathbf{u} = -(1/\sqrt{2})\mathbf{i} - (1/\sqrt{2})\mathbf{j}$ if $a < 0$
22. Use the definition of $\sin \theta$ and $\cos \theta$, as the y or x coordinate of a point on unit circle, θ radians counter clockwise from the x -axis.

23. $|\mathbf{v}| = \sqrt{2^2 + (-3)^2} = \sqrt{13}$ $\sin \theta = -3/\sqrt{13}$ $\cos \theta = 2/\sqrt{13}$
24. $|\mathbf{v}| = \sqrt{73}$ $\sin \theta = 8/\sqrt{73}$ $\cos \theta = -3/\sqrt{73}$
25. $|\mathbf{u}| = \sqrt{2}$ $\mathbf{v} = -(1/\sqrt{2})\mathbf{i} - (1/\sqrt{2})\mathbf{j}$
26. $|\mathbf{u}| = \sqrt{13}$ $\mathbf{v} = -(2/\sqrt{13})\mathbf{i} + (3/\sqrt{13})\mathbf{j}$ (Notice direction \mathbf{v} = direction $\mathbf{u} - \pi$!).
27. $|\mathbf{u}| = 5$ $\mathbf{v} = (3/5)\mathbf{i} - (4/5)\mathbf{j}$
28. $|\mathbf{u}| = \sqrt{13}$ $\mathbf{v} = (2/\sqrt{13})\mathbf{i} - (3/\sqrt{13})\mathbf{j}$
29. (a) $\mathbf{u} + \mathbf{v} = \mathbf{i} - \mathbf{j}$ $(\mathbf{u} + \mathbf{v})/|\mathbf{u} + \mathbf{v}| = (1/\sqrt{2})\mathbf{i} - (1/\sqrt{2})\mathbf{j}$
 (b) $2\mathbf{u} - 3\mathbf{v} = 7\mathbf{i} - 12\mathbf{j}$ $(2\mathbf{u} - 3\mathbf{v})/|2\mathbf{u} - 3\mathbf{v}| = (7/\sqrt{193})\mathbf{i} - (12/\sqrt{193})\mathbf{j}$
 (c) $3\mathbf{u} + 8\mathbf{v} = -2\mathbf{i} + 7\mathbf{j}$ $(3\mathbf{u} + 8\mathbf{v})/|3\mathbf{u} + 8\mathbf{v}| = -(2/\sqrt{53})\mathbf{i} + (7/\sqrt{53})\mathbf{j}$
30. $|\overrightarrow{PQ}| = \sqrt{(c+a-c)^2 + (d+b-d)^2} = \sqrt{a^2 + b^2}$
31. An equation of the line passing through the points O and R is $bx - ay = 0$. An equation of the line passing through the points P and Q is $bx - ay + ad - bc = 0$. Since the lines are parallel, the direction of \overrightarrow{PQ} is the same as the direction of the vector (a, b) .
32. $\mathbf{v} = (3 \cos \pi/6, 3 \sin \pi/6) = (3\sqrt{3}/2, 3/2)$
33. $\mathbf{v} = (8 \cos \pi/3, 8 \sin \pi/3) = (4, 4\sqrt{3})$
34. $\mathbf{v} = (\cos \pi/4, \sin \pi/4) = (1/\sqrt{2}, 1/\sqrt{2})$
35. $\mathbf{v} = (6 \cos 2\pi/3, 6 \sin 2\pi/3) = (-3, 3\sqrt{3})$
36. Let $\mathbf{u} = (u_1, u_2)$ and $\mathbf{v} = (v_1, v_2)$. Show that $u_1v_1 + u_2v_2 \leq \sqrt{(u_1^2 + u_2^2)(v_1^2 + v_2^2)}$ by squaring both sides. Then

$$\begin{aligned} |\mathbf{u} + \mathbf{v}|^2 &= |(u_1, u_2) + (v_1, v_2)|^2 = (u_1 + v_1)^2 + (u_2 + v_2)^2 \\ &= u_1^2 + u_2^2 + 2(u_1v_1 + u_2v_2) + v_1^2 + v_2^2 \\ &\leq |\mathbf{u}|^2 + 2\sqrt{(u_1^2 + u_2^2)(v_1^2 + v_2^2)} + |\mathbf{v}|^2 \\ &= (|\mathbf{u}| + |\mathbf{v}|)^2 \end{aligned}$$

Taking square roots, we obtain $|\mathbf{u} + \mathbf{v}| \leq |\mathbf{u}| + |\mathbf{v}|$.

37. Let $\mathbf{u} = (u_1, u_2)$ and $\mathbf{v} = (v_1, v_2)$. Suppose $|\mathbf{u} + \mathbf{v}| = |\mathbf{u}| + |\mathbf{v}|$. The proof in problem 36 shows that $|\mathbf{u} + \mathbf{v}|^2 = |\mathbf{u}|^2 + |\mathbf{v}|^2 + 2(u_1v_1 + u_2v_2)$; hence we must have $(u_1v_1 + u_2v_2) = |\mathbf{u}||\mathbf{v}| > 0$, as neither \mathbf{u} nor \mathbf{v} is the zero vector. Squaring both sides of $(u_1v_1 + u_2v_2) = |\mathbf{u}||\mathbf{v}|$ and simplifying gives $u_1v_2 = u_2v_1$. We may assume $v_1 \neq 0$. Then $\mathbf{u} = (u_1, u_2) = \frac{u_1}{v_1}(v_1, v_2) = \alpha\mathbf{v}$. But plugging into $u_1v_1 + u_2v_2 > 0$ gives $\alpha > 0$. Conversely, suppose $\mathbf{u} = \alpha\mathbf{v}$ for some $\alpha > 0$. Then $|\mathbf{u} + \mathbf{v}| = |(\alpha + 1)\mathbf{v}| = (\alpha + 1)|\mathbf{v}| = \alpha|\mathbf{v}| + |\mathbf{v}| = |\alpha\mathbf{v}| + |\mathbf{v}| = |\mathbf{u}| + |\mathbf{v}|$.

CALCULATOR SOLUTIONS 3.1

The problems in this section ask you to compute the magnitude and direction (in radians and degrees) for four groups of vectors; within each group the vectors differ only by the signs of their coordinates. One way to solve these is to solve all four problems (in radian form) by:

[*x-value,y-value*] **[STO▶]** *varname* **[ENTER]** to enter the first in the group (and to check the accuracy of your entry).

varname **[2nd]** **[VECTR]** **[F4]** **[<OPS>]** **[F3]** **[<▶Pol>]** **[ENTER]** to convert to polar form (magnitude and angle - say in radians)

[2nd] **[ENTRY]** to recall the previous entry (which will include the function **▶Pol**)

Then use the arrow keys and **[DEL]** or **[2nd]** **[INS]** to delete or insert the – signs in the appropriate places, and then **[ENTER]** will produce the (same) magnitude and new direction.

Repeat the **[2nd]** **[ENTRY]** and editing steps for the remaining sign changes.

Now change to degree mode by **[2nd]** **[MODE]** **[▼]** **[▼]** **[▼]** **[▶]** **[ENTER]** **[EXIT]** (or just omit the **[▶]** if TI-85 is already in degree mode and you wish to return to radian mode).

Then repeat the **[2nd]** **[ENTRY]** and editing steps to get the magnitudes and directions in degrees for the four problems in the group.

In our solutions below we indicate input and answers in radians and degrees for each separate problem, without describing the mechanism for changing between these two modes, or recalling the previous entry (or answer) for editing.

38. Enter [1.735, 2.437] **[STO▶]** A3138 **[ENTER]** and then in radian mode A3138 **[<▶Pol>** yields:
 [2.99152034925∠.95210120347] or in degrees: [2.99152034925∠54.5513806263°]
39. Enter [1.735, -2.437] **[STO▶]** A3139 **[ENTER]** and then A3139 **[<▶Pol>** (the menu item) yields:
 [2.99152034925∠-.95210120347] or in degrees: [2.99152034925∠-54.5513806263°].
 Notice negating the y coordinate in problem 38 just negates the angle.
40. Enter [-1.735, 2.437] **[STO▶]** A3140 **[ENTER]** and then A3140 **[<▶Pol>** (the menu item) yields:
 [2.99152034925∠2.18949145015] or in degrees: [2.99152034925∠125.448619374°].
 Notice that negating both coordinates (from A3139) just adds π radians (or 180°) to the (negative) angle.
41. Enter [-1.735, -2.437] **[STO▶]** A3141 **[ENTER]** and then A3141 **[<▶Pol>** (the menu item) yields:
 [2.99152034925∠-2.18949145015] or in degrees:
 [2.99152034925∠-125.448619374°]. Notice that negating the x coordinate (from A3139) just complements the (negative) angle with respect to $-\pi$ radians (or -180°).
42. Enter [-58, 99] **[STO▶]** A3142 **[ENTER]** and then A3142 **[<▶Pol>** yields:
 [114.738833879∠2.10075283072] or in degrees: [114.738833879∠120.364271°]
43. Enter [-58, -99] **[STO▶]** A3143 **[ENTER]** and then A3143 **[<▶Pol>** yields:

[114.738833879 \angle -2.10075283072] or in degrees: [114.738833879 \angle -120.364271 $^\circ$]

44. Enter [58,99] **[STO▶]** A3144 **[ENTER]** and then A3144 **<▶Pol>** yields:
[.848066624741 \angle 1.04083982287] or in degrees: [114.738833879 \angle 59.6357289998 $^\circ$]
45. Enter [58,-99] **[STO▶]** A3145 **[ENTER]** and then A3145 **<▶Pol>** yields:
[114.738833879 \angle -1.04083982287] or in degrees: [114.738833879 \angle -59.6357289998 $^\circ$]
46. Enter [0.01468,-0.08517] **[STO▶]** A3146 **[ENTER]** and then A3146 **<▶Pol>** yields:
[.086425871705 \angle -1.40011222941] or in degrees: [.086425871705 \angle -80.2205215899 $^\circ$]
47. Enter [0.014168,0.08517] **[STO▶]** A3147 **[ENTER]** and then A3147 **<▶Pol>** yields:
[.086425871705 \angle 1.40011222941] or in degrees: [.086425871705 \angle 80.2205215899 $^\circ$]
48. Enter [-0.014168,-0.08517] **[STO▶]** A3148 **[ENTER]** and then A3148 **<▶Pol>** yields:
[.086425871705 \angle -1.74148042418] or in degrees: [.086425871705 \angle -99.7794784101 $^\circ$]
49. Enter [-0.014168,0.08517] **[STO▶]** A3145 **[ENTER]** and then A3145 **<▶Pol>** yields:
[.086425871705 \angle -1.74148042418] or in degrees: [.086425871705 \angle 99.7794784101 $^\circ$]

MATLAB 3.1

1. (a) Notice that for vectors in the second or third quadrant, we must add π to the arctangent in order to get the direction.

```

>> v = [4; 4];                % Problem 1.
>> norm(v)
ans =
    5.6569

>> direction = atan( v(2)/v(1) )
direction =
    0.7854

>> deg = direction*180/pi
deg =
    45

>> v = [4; -4];              % Problem 3.
>> norm(v)
ans =
    5.6569

>> direction = atan( v(2)/v(1) )
direction =
   -0.7854

>> deg = direction*180/pi
deg =
   -45

>> v = [sqrt(3); 1];        % Problem 5.
>> norm(v)
ans =
    2

>> direction = atan( v(2)/v(1) )
direction =
    0.5236

>> deg = direction*180/pi
deg =
   30.0000

>> v = [-1; sqrt(3)];      % Problem 7.
>> norm(v)
ans =
    2

>> direction = atan( v(2)/v(1) ) + pi
direction =
    2.0944

>> deg = direction*180/pi
deg =
  120.0000

>> v = [-1; -sqrt(3)];    % Problem 9.
>> norm(v)
ans =
    2
    
```

```
>> direction = atan( v(2)/v(1) ) + pi
direction =
    4.1888

>> deg = direction*180/pi
deg =
    240.0000

>> v = [-5; -8];           % Problem 11.
>> norm(v)
ans =
    9.4340

>> direction = atan( v(2)/v(1) ) + pi
direction =
    4.1538

>> deg = direction*180/pi
deg =
    237.9946
```

(b)

```
>> v = [ 1.735; 2.437];           % Problem 38.
>> norm(v)
ans =
    2.9915

>> direction = atan( v(2)/v(1) )
direction =
    0.9521

>> deg = direction*180/pi
deg =
    54.5514

>> v = [ -1.735; 2.437];           % Problem 40.
>> norm(v)
ans =
    2.9915

>> direction = atan( v(2)/v(1) ) + pi
direction =
    2.1895

>> deg = direction*180/pi
deg =
    125.4486

>> v = [ -58; 99];           % Problem 42.
>> norm(v)
ans =
    114.7388

>> direction = atan( v(2)/v(1) ) + pi
direction =
    2.1008

>> deg = direction*180/pi
deg =
    120.3643
```



```

>> v = [ 58; 99];           % Problem 44.
>> norm(v)
ans =
    114.7388

>> direction = atan( v(2)/v(1) )
direction =
    1.0408

>> deg = direction*180/pi
deg =
    59.6357

>> v = [ 0.01468; -0.08517]; % Problem 46.
>> norm(v)
ans =
    0.0864

>> direction = atan( v(2)/v(1) )
direction =
   -1.4001

>> deg = direction*180/pi
deg =
   -80.2205

>> v = [ -0.01468; -0.08517]; % Problem 48.
>> norm(v)
ans =
    0.0864

>> direction = atan( v(2)/v(1) ) + pi
direction =
    4.5417

>> deg = direction*180/pi
deg =
    260.2205
    
```

2. (a)

```

>> u = [2;.5];    v = [-1;2];
>> w = u+v; ww = u-v; aa = [u' v' w' ww']; M = max(abs(aa));
>> axis('square'); axis([-M M -M M])
>> hold on
>> plot( [0 v(1)], [0 v(2)], [0 u(1)], [0 u(2)] )
>> grid
    
```

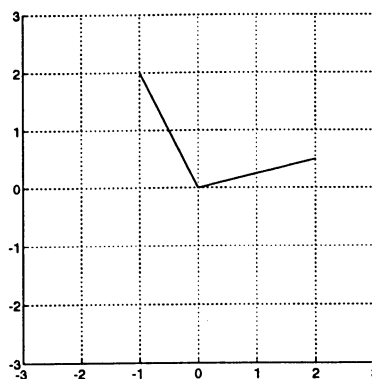

```

>> a = 1; b = 1;
>> z = a*u+b*v;
>> plot([0 z(1)], [0 z(2)], 'c5')
>> a = .5; b = 1;
>> z = a*u+b*v;

>> plot([0 z(1)], [0 z(2)], 'c5')
>> a = .5; b = .5;
>> z = a*u+b*v;
>> plot([0 z(1)], [0 z(2)], 'c5')
>> a = .2; b = .8;

>> z = a*u+b*v;
>> plot([0 z(1)], [0 z(2)], 'c5')
>> a = .7; b = .2;
>> z = a*u+b*v;
>> plot([0 z(1)], [0 z(2)], 'c5')

```

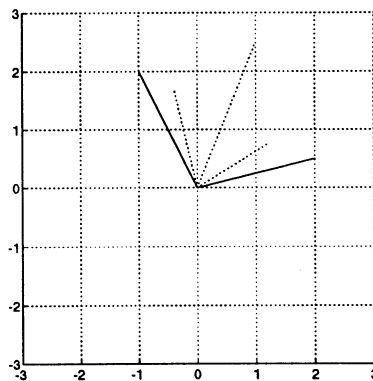

If many more a and b were chosen, with $0 \leq a, b \leq 1$, then the parallelogram between \mathbf{u} and \mathbf{v} would start to be filled in.

```

>> a = 1; b = -1;
>> z = a*u+b*v;
>> plot([0 z(1)], [0 z(2)], 'c6')
>> a = .1; b = -1;

```

```

>> z = a*u+b*v;
>> plot([0 z(1)], [0 z(2)], '--c6')
>> a = .5; b = -.5;
>> z = a*u+b*v;
>> plot([0 z(1)], [0 z(2)], '--c6')

>> a = .2; b = -.8;
>> z = a*u+b*v;
>> plot([0 z(1)], [0 z(2)], '--c6')
>> a = .7; b = -.2;
>> z = a*u+b*v;
>> plot([0 z(1)], [0 z(2)], '--c6')
    
```

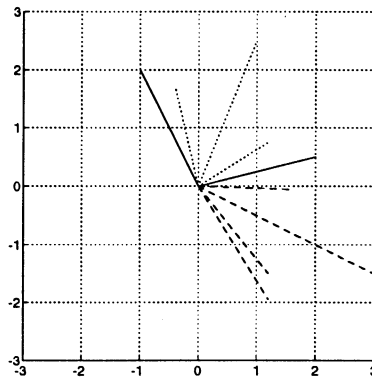

If many more a and b were chosen, with $0 \leq a \leq 1$ and $-1 \leq b \leq 0$, then the parallelogram between \mathbf{u} and $-\mathbf{v}$ would start to be filled in.

```

>> a = -1; b = 1;
>> z = a*u+b*v;
>> plot([0 z(1)], [0 z(2)], '-.c6')

>> a = -.5; b = 1;
>> z = a*u+b*v;
>> plot([0 z(1)], [0 z(2)], '-.c6')

>> a = -1; b = .5;
>> z = a*u+b*v;
>> plot([0 z(1)], [0 z(2)], '-.c6')

>> a = -.6; b = .2;
>> z = a*u+b*v;
>> plot([0 z(1)], [0 z(2)], '-.c6')

>> a = -.4; b = .7;
>> z = a*u+b*v;
>> plot([0 z(1)], [0 z(2)], '-.c6')

>> a = -1; b = 0;
>> z = a*u+b*v;
>> plot([0 z(1)], [0 z(2)], '-.c6')
    
```

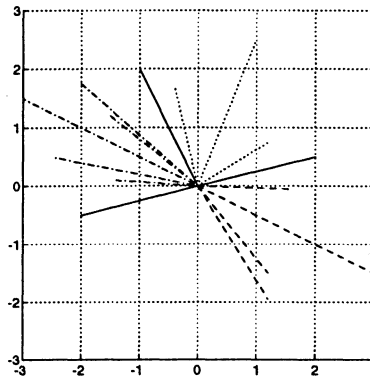

As above, these fill in the parallelogram between $-\mathbf{u}$ and \mathbf{v} .

If we allow both a and b to be negative, then we will cover the fourth quarter of this parallelogram. If we allow a and b to grow, then we would get larger and larger region, which eventually covers everything in the plane.

- (b) If the above is repeated when \mathbf{u} and \mathbf{v} are parallel, the linear combinations of \mathbf{u} and \mathbf{v} will all lie on the same line through the origin.

3.

```
>> u = [2;.5];    v = [-1;2];    % Pick two vectors.
>> w = [ .5; -3]; % Pick a third vector, or use rand(2,1).
>> lincomb(u,v,w)
```

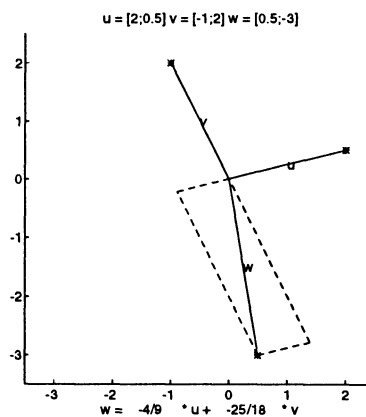

Section 3.2

1. $\mathbf{u} \cdot \mathbf{v} = (1)(1) + (1)(-1) = 0$; $\cos \varphi = 0$
2. $\mathbf{u} \cdot \mathbf{v} = (3)(0) + (0)(-7) = 0$; $\cos \varphi = 0$
3. $\mathbf{u} \cdot \mathbf{v} = (-5)(0) + (0)(18) = 0$; $\cos \varphi = 0$
4. $\mathbf{u} \cdot \mathbf{v} = (\alpha)(0) + (0)(\beta) = 0$; $\cos \varphi = 0$
5. $\mathbf{u} \cdot \mathbf{v} = (2)(5) + (5)(2) = 20$; $\cos \varphi = \frac{20}{\sqrt{29}\sqrt{29}} = \frac{20}{29}$
6. $\mathbf{u} \cdot \mathbf{v} = (2)(5) + (5)(-2) = 0$; $\cos \varphi = 0$
7. $\mathbf{u} \cdot \mathbf{v} = (-3)(-2) + (4)(-7) = -22$ $\cos \varphi = \frac{-22}{\sqrt{25}\sqrt{53}} = \frac{-22}{5\sqrt{53}}$
8. $\mathbf{u} \cdot \mathbf{v} = (4)(5) + (5)(-4) = 0$ $\cos \varphi = 0$
9. $\mathbf{u} \cdot \mathbf{v} = (\alpha)(\beta) + (\beta)(-\alpha) = 0 \Rightarrow \cos \varphi = 0 \Rightarrow \varphi = \pi/2 \Rightarrow \mathbf{u}$ and \mathbf{v} are orthogonal.
10. The scalar product is an operation in which the input is two vectors and the output is a number. Then $\mathbf{u} \cdot \mathbf{v} \cdot \mathbf{w}$ is not defined: once we take the first scalar product, we would then need to take the scalar product of a number and a vector, which does not make sense.
11. $\mathbf{v} = -2\mathbf{u} \Rightarrow \mathbf{u}$ and \mathbf{v} are parallel.
12. $\mathbf{u} \cdot \mathbf{v} = (2)(6) + (3)(-4) = 0 \Rightarrow \cos \varphi = 0 \Rightarrow \varphi = \pi/2 \Rightarrow \mathbf{u}$ and \mathbf{v} are orthogonal.
13. $\mathbf{u} \cdot \mathbf{v} = (2)(6) + (3)(4) = 24$ $\cos \varphi = \frac{24}{\sqrt{13}\sqrt{52}} = \frac{24}{26} \Rightarrow \mathbf{u}$ and \mathbf{v} are not parallel and not orthogonal.
14. $\mathbf{u} \cdot \mathbf{v} = (2)(-6) + (3)(4) = 0 \Rightarrow \cos \varphi = 0 \Rightarrow \varphi = \pi/2 \Rightarrow \mathbf{u}$ and \mathbf{v} are orthogonal.
15. $\mathbf{u} \cdot \mathbf{v} = (7)(0) + (0)(-23) = 0 \Rightarrow \cos \varphi = 0 \Rightarrow \varphi = \pi/2 \Rightarrow \mathbf{u}$ and \mathbf{v} are orthogonal.
16. $\mathbf{v} = -\mathbf{u}/2 \Rightarrow \mathbf{u}$ and \mathbf{v} are parallel.
17. (a) We need $\mathbf{u} \cdot \mathbf{v} = 3 + 4\alpha = 0 \Rightarrow 4\alpha = -3 \Rightarrow \alpha = -3/4$
 (b) $\mathbf{u}/3 = \mathbf{i} + (4/3)\mathbf{j} \Rightarrow \alpha = 4/3$
 (c) We need $\cos \varphi = \frac{3 + 4\alpha}{5\sqrt{\alpha^2 + 1}} = \frac{\sqrt{2}}{2} \Rightarrow 6 + 8\alpha = 5\sqrt{2\alpha^2 + 2} \Rightarrow 36 + 96\alpha + 64\alpha^2 = 25(2\alpha^2 + 2) \Rightarrow 14\alpha^2 + 96\alpha - 14 = 0 \Rightarrow 7\alpha^2 + 48\alpha - 7 = 0 \Rightarrow (7\alpha - 1)(\alpha + 7) = 0 \Rightarrow \alpha = 1/7$ or $\alpha = -7$.
 $\alpha = 1/7 \Rightarrow \varphi = \pi/4$, $\alpha = -7 \Rightarrow \varphi = 3\pi/4$, so only $\alpha = 1/7$.
 (d) We need $\cos \varphi = \frac{3 + 4\alpha}{5\sqrt{\alpha^2 + 1}} = \frac{1}{2} \Rightarrow 6 + 8\alpha = 5\sqrt{\alpha^2 + 1} \Rightarrow 36 + 96\alpha + 64\alpha^2 = 25\alpha^2 + 25 \Rightarrow 39\alpha^2 + 96\alpha + 11 = 0 \Rightarrow \alpha = \frac{-48 + 25\sqrt{3}}{39} \Rightarrow \varphi = \pi/3$. (The other gives α with $\varphi = \frac{5\pi}{3}$).
18. (a) We need $\mathbf{u} \cdot \mathbf{v} = -2\alpha - 10 = 0 \Rightarrow \alpha = -5$
 (b) $-2\mathbf{u}/5 = (4/5)\mathbf{i} - 2\mathbf{j} \Rightarrow \alpha = 4/5$
 (c) We need $\cos \varphi = \frac{-2\alpha - 10}{\sqrt{29}\sqrt{\alpha^2 + 4}} = \frac{-1}{2} \Rightarrow 16\alpha + 160\alpha + 400 = 29\alpha + 116 \Rightarrow 13\alpha^2 - 160\alpha - 284 = 0 \Rightarrow \alpha = \frac{80 \pm 58\sqrt{3}}{13} \Rightarrow \varphi = 2\pi/3$
 (d) We need $\cos \varphi = \frac{-2\alpha - 10}{\sqrt{29}\sqrt{\alpha^2 + 4}} = \frac{1}{2}$; from c), we can see that there is no solution.
19. Since the \mathbf{i} components of \mathbf{u} and \mathbf{v} are both positive and fixed, it is impossible for \mathbf{u} and \mathbf{v} to have opposite directions.
20. Since the \mathbf{j} component of \mathbf{u} is positive and the \mathbf{j} component of \mathbf{v} is negative, it is impossible for \mathbf{u} and \mathbf{v} to have the same direction.

In 21–31 we use $\text{proj}_{\mathbf{v}} \mathbf{u} = \frac{\mathbf{u} \cdot \mathbf{v}}{\mathbf{v} \cdot \mathbf{v}} \mathbf{v}$.

$$21. \text{proj}_{\mathbf{v}} \mathbf{u} = \frac{3}{2}(\mathbf{i} + \mathbf{j}) = \frac{3}{2}\mathbf{i} + \frac{3}{2}\mathbf{j}$$

$$23. \text{proj}_{\mathbf{v}} \mathbf{u} = 0, \text{ as } \mathbf{u} \cdot \mathbf{v} = 0$$

$$25. \text{proj}_{\mathbf{v}} \mathbf{u} = \frac{-1}{13}(2\mathbf{i} - 3\mathbf{j}) = \frac{-2}{13}\mathbf{i} + \frac{3}{13}\mathbf{j}$$

$$27. \text{proj}_{\mathbf{v}} \mathbf{u} = \frac{\alpha + \beta}{2}(\mathbf{i} + \mathbf{j})$$

$$29. \text{proj}_{\mathbf{v}} \mathbf{u} = \frac{\alpha - \beta}{2}(\mathbf{i} + \mathbf{j})$$

$$22. \text{proj}_{\mathbf{v}} \mathbf{u} = \frac{-5}{2}(\mathbf{i} + \mathbf{j}) = \frac{-5}{2}\mathbf{i} - \frac{5}{2}\mathbf{j}$$

$$24. \text{proj}_{\mathbf{v}} \mathbf{u} = \frac{11}{17}(4\mathbf{i} + \mathbf{j}) = \frac{44}{17}\mathbf{i} + \frac{11}{17}\mathbf{j}$$

$$26. \text{proj}_{\mathbf{v}} \mathbf{u} = \frac{5}{13}(2\mathbf{i} + 3\mathbf{j}) = \frac{10}{13}\mathbf{i} + \frac{15}{13}\mathbf{j}$$

$$28. \text{proj}_{\mathbf{v}} \mathbf{u} = \frac{\alpha + \beta}{\alpha^2 + \beta^2}(\alpha\mathbf{i} + \beta\mathbf{j})$$

$$30. \text{proj}_{\mathbf{v}} \mathbf{u} = \frac{\alpha - \beta}{2}(\mathbf{i} + \mathbf{j})$$

$$31. \text{proj}_{\mathbf{v}} \mathbf{u} = \frac{a_1 a_2 + b_1 b_2}{\sqrt{a_2^2 + b_2^2}}(a_2 \mathbf{i} + b_2 \mathbf{j}). \text{ In order for } \mathbf{v} \text{ and } \text{proj}_{\mathbf{v}} \mathbf{u} \text{ to have the same direction, we need } a_1 a_2 + b_1 b_2 > 0.$$

$$32. \text{ In order for } \mathbf{v} \text{ and } \text{proj}_{\mathbf{v}} \mathbf{u} \text{ to have opposite directions, we need } a_1 a_2 + b_1 b_2 < 0.$$

$$33. \vec{PQ} = 3\mathbf{i} + 4\mathbf{j}; \vec{RS} = -\mathbf{i} + 5\mathbf{j}; \text{proj}_{\vec{PQ}} \vec{RS} = \frac{17}{25}(3\mathbf{i} + 4\mathbf{j}) = \frac{51}{25}\mathbf{i} + \frac{68}{25}\mathbf{j}; \text{proj}_{\vec{RS}} \vec{PQ} = \frac{17}{26}(-\mathbf{i} + 5\mathbf{j}) = \frac{-17}{26}\mathbf{i} + \frac{85}{26}\mathbf{j}$$

$$34. \vec{PQ} = 3\mathbf{i} + \mathbf{j}; \vec{RS} = 9\mathbf{i} + 2\mathbf{j}; \text{proj}_{\vec{PQ}} \vec{RS} = \frac{29}{10}(3\mathbf{i} + \mathbf{j}) = \frac{87}{10}\mathbf{i} + \frac{29}{10}\mathbf{j}; \text{proj}_{\vec{RS}} \vec{PQ} = \frac{29}{85}(9\mathbf{i} + 2\mathbf{j}) = \frac{261}{85}\mathbf{i} + \frac{58}{85}\mathbf{j}$$

$$35. \text{ Let } \mathbf{u} = a\mathbf{i} + b\mathbf{j}, \mathbf{v} = c\mathbf{i} + d\mathbf{j}, \text{ with } a \text{ and } b \text{ not both zero and } c \text{ and } d \text{ not both zero. Suppose } \cos \varphi = \frac{ac + bd}{\sqrt{a^2 + b^2}\sqrt{c^2 + d^2}} = \pm 1 \Rightarrow ac + bd = \sqrt{(a^2 + b^2)(c^2 + d^2)} \Rightarrow a^2 c^2 + 2abcd + b^2 d^2 = a^2 c^2 + a^2 d^2 + b^2 c^2 + b^2 d^2 \Rightarrow a^2 d^2 - 2abcd + b^2 c^2 = 0 \Rightarrow (ad - bc)^2 = 0 \Rightarrow ad - bc = 0 \Rightarrow c = \frac{d}{b}a. \text{ Then } \frac{d}{b}\mathbf{u} = \frac{da}{b}\mathbf{i} + d\mathbf{j} = c\mathbf{i} + d\mathbf{j}. \text{ Then } \alpha = \frac{d}{b}. \text{ Suppose } \mathbf{u} = a\mathbf{i} + b\mathbf{j} \text{ and } \mathbf{v} = \alpha a\mathbf{i} + \alpha b\mathbf{j} \text{ for some constant } \alpha. \text{ Then}$$

$$\cos \varphi = \frac{\alpha a^2 + \alpha b^2}{\sqrt{a^2 + b^2}\sqrt{\alpha^2 a^2 + \alpha^2 b^2}} = \frac{\alpha(a^2 + b^2)}{|\alpha|(a^2 + b^2)} = \pm 1.$$

Thus, the nonzero vectors \mathbf{u} and \mathbf{v} are parallel if and only if $\mathbf{v} = \alpha\mathbf{u}$ for some constant α .

$$36. \text{ Suppose } \mathbf{u} \text{ and } \mathbf{v} \text{ are orthogonal. Then } \varphi = \pi/2. \text{ Then } \cos(\pi/2) = \frac{\mathbf{u} \cdot \mathbf{v}}{|\mathbf{u}||\mathbf{v}|} = 0 \Rightarrow \mathbf{u} \cdot \mathbf{v} = 0. \text{ Suppose } \mathbf{u} \cdot \mathbf{v} = 0. \text{ Then } \cos \varphi = 0 \Rightarrow \varphi = \pi/2 \Rightarrow \mathbf{u} \text{ and } \mathbf{v} \text{ are orthogonal.}$$

$$37. \text{ Note that } (0, -c/b) \text{ and } (-c/a, 0) \text{ are points on the line. Then the direction vector for the line is } \mathbf{u} = \frac{c}{a}\mathbf{i} - \frac{c}{b}\mathbf{j}. \text{ Then } \mathbf{u} \cdot \mathbf{v} = c - c = 0 \Rightarrow \mathbf{v} \text{ is orthogonal to the line } ax + by + c = 0.$$

$$38. \text{ The direction vector of the line is } \mathbf{v} = \frac{c}{a}\mathbf{i} - \frac{c}{b}\mathbf{j}. \text{ Then } \frac{ab}{c}\mathbf{v} = b\mathbf{i} - a\mathbf{j} = \mathbf{u} \Rightarrow \mathbf{u} \text{ is parallel to the line } ax + by + c = 0.$$

39. Let A , B , and C represent the points $(1, 3)$, $(4, -2)$, and $(-3, 6)$, respectively. Also, let A , B , and C represent the angles at the corresponding vertices. $\vec{AB} = 3\mathbf{i} - 5\mathbf{j}$; $\vec{AC} = -4\mathbf{i} + 3\mathbf{j}$;

$$\cos A = \frac{-27}{\sqrt{35}\sqrt{25}} = \frac{-27}{5\sqrt{35}}; \quad \vec{BA} = -3\mathbf{i} + 5\mathbf{j};$$

$$\cos B = \frac{61}{\sqrt{34}\sqrt{113}} = \frac{61}{\sqrt{3842}}; \quad \vec{CA} = 4\mathbf{i} - 3\mathbf{j}; \quad \vec{CB} = 7\mathbf{i} - 8\mathbf{j};$$

$$\cos C = \frac{52}{\sqrt{25}\sqrt{113}} = \frac{52}{5\sqrt{113}}.$$

40. Let A , B , C represent the points (a_1, b_1) , (a_2, b_2) , and (a_3, b_3) respectively. Also let A , B , and C represent the angles at the corresponding vertices.

$$\vec{AB} = (a_2 - a_1)\mathbf{i} + (b_2 - b_1)\mathbf{j}; \quad \vec{AC} = (a_3 - a_1)\mathbf{i} + (b_3 - b_1)\mathbf{j};$$

$$\cos A = \frac{(a_2 - a_1)(a_3 - a_1) + (b_2 - b_1)(b_3 - b_1)}{\sqrt{(a_2 - a_1)^2 + (b_2 - b_1)^2} \sqrt{(a_3 - a_1)^2 + (b_3 - b_1)^2}}$$

$$\text{Similarly, } \cos B = \frac{(a_1 - a_2)(a_3 - a_2) + (b_1 - b_2)(b_3 - b_2)}{\sqrt{(a_1 - a_2)^2 + (b_1 - b_2)^2} \sqrt{(a_3 - a_2)^2 + (b_3 - b_2)^2}}$$

$$\text{and } \cos C = \frac{(a_1 - a_3)(a_2 - a_3) + (b_1 - b_3)(b_2 - b_3)}{\sqrt{(a_1 - a_3)^2 + (b_1 - b_3)^2} \sqrt{(a_2 - a_3)^2 + (b_2 - b_3)^2}}$$

41. Let $\mathbf{u} = a_1\mathbf{i} + a_2\mathbf{j}$ and $\mathbf{v} = b_1\mathbf{i} + b_2\mathbf{j}$. $\mathbf{u} \cdot \mathbf{v} = |\mathbf{u}||\mathbf{v}| \cos \varphi$ where φ is the angle between \mathbf{u} and \mathbf{v} . Then $|\mathbf{u} \cdot \mathbf{v}| = |\mathbf{u}||\mathbf{v}| |\cos \varphi|$. But $|\cos \varphi| \leq 1$. Then $|\mathbf{u} \cdot \mathbf{v}| \leq |\mathbf{u}||\mathbf{v}|$. That is, the Cauchy-Schwarz inequality is true. Equality holds if $\cos \varphi = \pm 1$. That is, if \mathbf{u} and \mathbf{v} are parallel. (See 3.1, #35 and #37 also.)

42. Let $y = mx + c$ and (a, b) be any non-vertical line and any point. Let (x, y) be any point on the line. To minimize the distance between (a, b) and the line, minimize $d = (x - a)^2 + (y - b)^2$.

$$d = (x - a)^2 + (mx + c - b)^2. \quad d' = 2(x - a) + 2(mx + c - b)(m) = 0 \Rightarrow x = \frac{a + bm - cm}{1 + m^2}. \quad \text{Then}$$

$$y = \frac{am + bm^2 + c}{1 + m^2}. \quad \text{Let } \mathbf{u} = (a - x)\mathbf{i} + (b - y)\mathbf{j} = \frac{am^2 - bm + cm}{1 + m^2}\mathbf{i} + \frac{b - am - c}{1 + m^2}\mathbf{j}. \quad \text{Let } \mathbf{v} = \text{direction}$$

$$\text{vector of the line} = \frac{c}{m}\mathbf{i} + \mathbf{j}. \quad \text{Then } \mathbf{u} \cdot \mathbf{v} = \frac{acm - bc + c^2 + bc - acm - c^2}{1 + m^2} = 0. \quad \text{If we have a vertical}$$

line, then $x = c$. Then we need to minimize $d = (c - a)^2 + (y - b)^2$. $d' = 2(y - b) = 0 \Rightarrow y = b \Rightarrow$ The shortest distance between a point and a line is measured along the line through the point and perpendicular to the line.

43. The line through the points Q and R is given by the equation $y = (-1/2)x + 13/2$. The perpendicular line through P is then $y = 2x - 1$ and these lines intersect at the point $R = (3, 5)$. The distance from P to R is $d = \sqrt{(3 - 2)^2 + (5 - 3)^2} = \sqrt{5}$.

44. The line has the equation $y = (-3/2)x$; the perpendicular line through $(3, 7)$ is $y = (2/3)x + 5$. These lines intersect at $(-30/13, 45/13)$. Then $d = \sqrt{\left(3 - \frac{30}{13}\right)^2 + \left(7 - \frac{45}{13}\right)^2} = \frac{\sqrt{2197}}{13}$

45. Let $A = \begin{pmatrix} a & b \\ c & d \end{pmatrix}$. Then $a^2 + c^2 = 1$, $b^2 + d^2 = 1$, $ab + cd = 0$. Then $A^t = \begin{pmatrix} a & c \\ b & d \end{pmatrix}$. $A^t A = \begin{pmatrix} a^2 + c^2 & ab + cd \\ ab + cd & b^2 + d^2 \end{pmatrix} = \begin{pmatrix} 1 & 0 \\ 0 & 1 \end{pmatrix}$. Thus $A^{-1} = A^t$.

CALCULATOR SOLUTIONS 3.2

The problems in this section ask you to compute unit vectors and projections. Our solutions for the TI-85 start with data entered into appropriate variables and then compute either `unitV_name` or `dot(vec1,vec2)/dot(vec2,vec2)*vec2`, as appropriate. Note that to compute $\text{proj}_v u$ you can first convert v to a unit vector (call it W) and then use the simpler projection formula: `dot(U,W)*W`. As usual you can either use the **VECTR MATH** menu or just literal input to access the `unitV` and `dot` functions. (We shall continue to use upper-case function names, like `UNITV` or `DOT(,` in showing literal input, since these are easier to key in.)

46. `UNITV A3246 [ENTER]` yields [.272384259987 .96218855476].
47. `UNITV A3247 [ENTER]` yields [-.88449617907 .466547435414].
48. `UNITV A3248 [ENTER]` yields [.176120122067 -.984368682254].
49. `UNITV A3249 [ENTER]` yields [-.27075830549 -.962647360152].
50. `UNITV A3250 [ENTER]` yields [-.328197831068 .944609011011].
51. `DOT(U3251,V3251)/DOT(V3251,V3251)*V3251 [ENTER]` yields the projection (of U3251 onto V3251): [-1.42889364286 -2.66927522328]. (As an alternate, you can enter `UNITV V3251 [ENTER] DOT(U3251,Ans)*Ans [ENTER]` to get the same answer, where `Ans` must be entered in the mixed upper-lower case shown, or by use of the `[2nd] [ANS]` keys.)

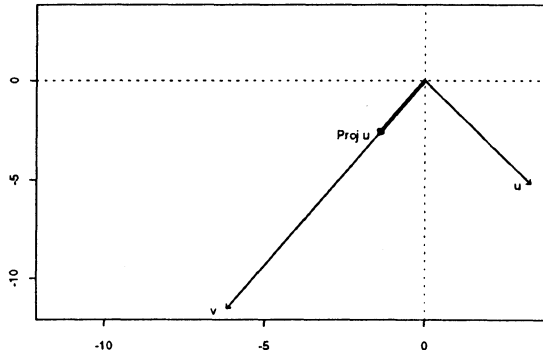

52. `DOT(U3252,V3252)/DOT(V3252,V3252)*V3252 [ENTER]` yields the projection (of U3252 onto V3252): [.015768770218 2.29651652915E-4]. (See Problem 51 for an alternative.)

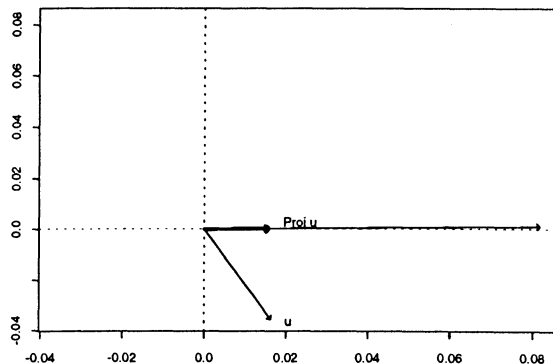

53. $\text{DOT}(U_{3253}, V_{3253}) / \text{DOT}(V_{3253}, V_{3253}) * V_{3253}$ yields the projection (of U_{3253} onto V_{3253}): [-6164.36315451 3523.92922513].

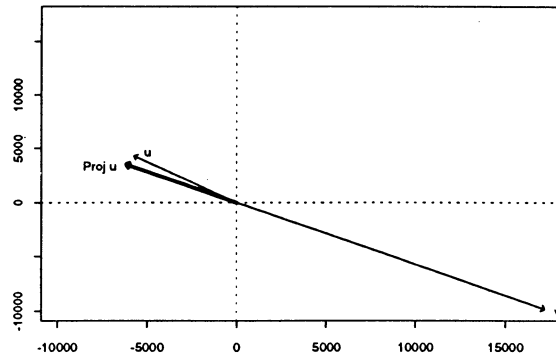

54. $\text{DOT}(U_{3254}, V_{3254}) / \text{DOT}(V_{3254}, V_{3254}) * V_{3254}$ yields the projection (of U_{3254} onto V_{3254}): [17318.0303616 49128.6105864].

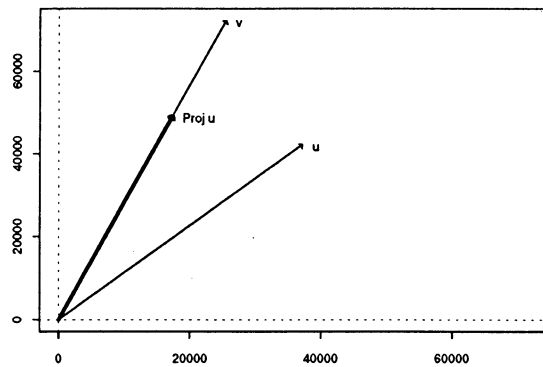

MATLAB 3.2

1.

```

>> u = [3; 0]; v = [1; 1]; % Problem 21.
>> p = (u' * v)/(v' * v) * v
p =
    1.5000
    1.5000

>> u = [0; -5]; v = [1; 1]; % Problem 22.
>> p = (u' * v)/(v' * v) * v
p =
   -2.5000
   -2.5000

>> u = [2; 1]; v = [1; -2]; % Problem 23.
>> p = (u' * v)/(v' * v) * v
p =
     0
     0

>> u = [2; 3]; v = [4; 1]; % Problem 24.
>> p = (u' * v)/(v' * v) * v
p =
    2.5882
    0.6471

>> u = [1; 1]; v = [2; -3]; % Problem 25.
>> p = (u' * v)/(v' * v) * v
p =
   -0.1538
    0.2308

>> u = [1; 1]; v = [2; 3]; % Problem 26.
>> p = (u' * v)/(v' * v) * v
p =
    0.7692
    1.1538

```

2.

(i)

```

>> u = [2;1]; v=[3;0];
>> p = (u' * v)/(v' * v) * v % Part (a), the projection computed.
p =
     2
     0

>> prjtn(u,v) % Part (b)

```

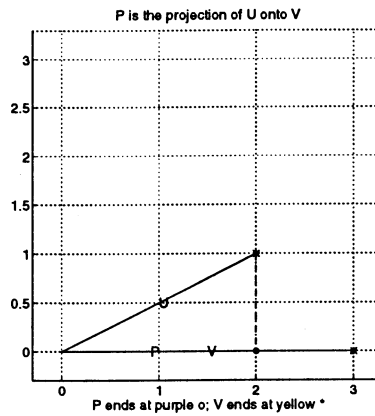

(ii)

```
>> u = [2;3]; v=[-3;0];
>> p = ( u' * v)/(v' * v) * v % Part (a).
p =
    2
    0

>> prjtn(u,v) % Part (b).
```

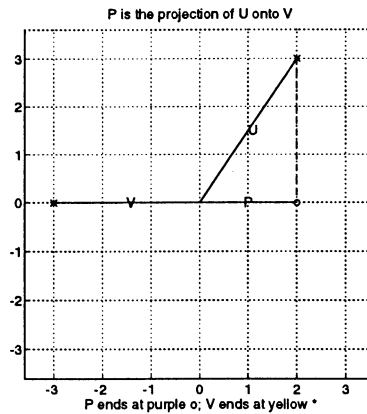

(iii)

```
>> u = [2;1]; v=[-1;2];
>> p = ( u' * v)/(v' * v) * v % Part (a).
p =
    0
    0

>> prjtn(u,v) % Part (b).
```

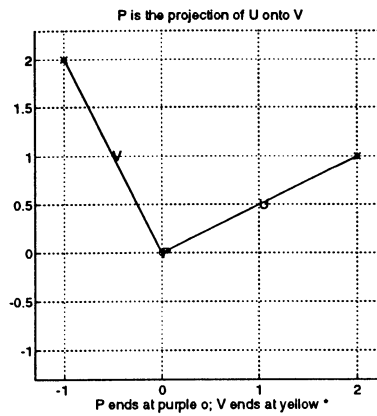

(iv)

```
>> u = [2;3]; v=[-1;-2];
>> p = ( u' * v)/(v' * v) * v % Part (a).
p =
    1.6000
    3.2000

>> prjtn(u,v) % Part (b).
```

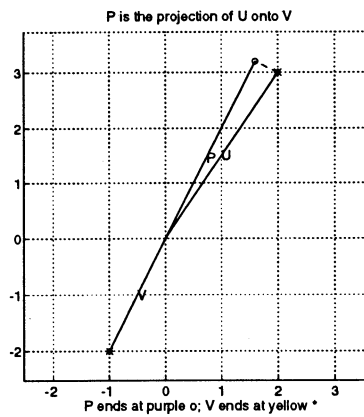

(c) The vector $\mathbf{u} - \mathbf{p}$ is the component of \mathbf{u} which is orthogonal to \mathbf{v} .

Section 3.3

1. $\overline{PQ} = \sqrt{(3-3)^2 + (-4-2)^2 + (3-5)^2} = 2\sqrt{10}$
2. $\overline{PQ} = \sqrt{(3-3)^2 + (-4+4)^2 + (7-9)^2} = 2$
3. $\overline{PQ} = \sqrt{(-2-4)^2 + (1-1)^2 + (3-3)^2} = 6$
4. $|\mathbf{v}| = 3 \quad \mathbf{v}/|\mathbf{v}| = \mathbf{j} \quad \cos \alpha = 0 \quad \cos \beta = 1 \quad \cos \gamma = 0$
5. $|\mathbf{v}| = 3 \quad \mathbf{v}/|\mathbf{v}| = -\mathbf{i} \quad \cos \alpha = -1 \quad \cos \beta = 0 \quad \cos \gamma = 0$
6. $|\mathbf{v}| = \sqrt{4^2 + (-1)^2} = \sqrt{17} \quad \mathbf{v}/|\mathbf{v}| = (4/\sqrt{17})\mathbf{i} - (1/\sqrt{17})\mathbf{j}$
 $\cos \alpha = 4/\sqrt{17} \quad \cos \beta = -1/\sqrt{17} \quad \cos \gamma = 0$
7. $|\mathbf{v}| = \sqrt{1^2 + 2^2} = \sqrt{5} \quad \mathbf{v}/|\mathbf{v}| = (1/\sqrt{5})\mathbf{i} + (2/\sqrt{5})\mathbf{k}$
 $\cos \alpha = 1/\sqrt{5} \quad \cos \beta = 0 \quad \cos \gamma = 2/\sqrt{5}$
8. $|\mathbf{v}| = \sqrt{1^2 + (-1)^2 + 1^2} = \sqrt{3} \quad \mathbf{v}/|\mathbf{v}| = (1/\sqrt{3})\mathbf{i} - (1/\sqrt{3})\mathbf{j} + (1/\sqrt{3})\mathbf{k}$
 $\cos \alpha = 1/\sqrt{3} \quad \cos \beta = -1/\sqrt{3} \quad \cos \gamma = 1/\sqrt{3}$
9. $|\mathbf{v}| = \sqrt{1^2 + 1^2 + (-1)^2} = \sqrt{3} \quad \mathbf{v}/|\mathbf{v}| = (1/\sqrt{3})\mathbf{i} + (1/\sqrt{3})\mathbf{j} - (1/\sqrt{3})\mathbf{k}$
 $\cos \alpha = 1/\sqrt{3} \quad \cos \beta = 1/\sqrt{3} \quad \cos \gamma = -1/\sqrt{3}$
10. $|\mathbf{v}| = \sqrt{3} \quad \mathbf{v}/|\mathbf{v}| = -(1/\sqrt{3})\mathbf{i} + (1/\sqrt{3})\mathbf{j} + (1/\sqrt{3})\mathbf{k}$
 $\cos \alpha = -1/\sqrt{3} \quad \cos \beta = 1/\sqrt{3} \quad \cos \gamma = 1/\sqrt{3}$
11. $|\mathbf{v}| = \sqrt{3} \quad \cos \alpha = 1/\sqrt{3} \quad \cos \beta = -1/\sqrt{3} \quad \cos \gamma = -1/\sqrt{3}$
12. $|\mathbf{v}| = \sqrt{3} \quad \cos \alpha = -1/\sqrt{3} \quad \cos \beta = 1/\sqrt{3} \quad \cos \gamma = -1/\sqrt{3}$
13. $|\mathbf{v}| = \sqrt{3} \quad \cos \alpha = -1/\sqrt{3} \quad \cos \beta = -1/\sqrt{3} \quad \cos \gamma = 1/\sqrt{3}$
14. $|\mathbf{v}| = \sqrt{3} \quad \cos \alpha = -1/\sqrt{3} \quad \cos \beta = -1/\sqrt{3} \quad \cos \gamma = -1/\sqrt{3}$
15. $|\mathbf{v}| = \sqrt{2^2 + 5^2 + (-7)^2} = \sqrt{78} \quad \mathbf{v}/|\mathbf{v}| = (2/\sqrt{78})\mathbf{i} + (5/\sqrt{78})\mathbf{j} - (7/\sqrt{78})\mathbf{k}$
 $\cos \alpha = 2/\sqrt{78} \quad \cos \beta = 5/\sqrt{78} \quad \cos \gamma = -7/\sqrt{78}$
16. $|\mathbf{v}| = \sqrt{(-3)^2 + (-3)^2 + 8^2} = \sqrt{82} \quad \mathbf{v}/|\mathbf{v}| = -(3/\sqrt{82})\mathbf{i} - (3/\sqrt{82})\mathbf{j} + (8/\sqrt{82})\mathbf{k}$
 $\cos \alpha = \cos \beta = -3/\sqrt{82} \quad \cos \gamma = 8/\sqrt{82}$
17. $|\mathbf{v}| = \sqrt{(-2)^2 + (-3)^2 + (-4)^2} = \sqrt{29} \quad \mathbf{v}/|\mathbf{v}| = -(2/\sqrt{29})\mathbf{i} - (3/\sqrt{29})\mathbf{j} - (4/\sqrt{29})\mathbf{k}$
 $\cos \alpha = -2/\sqrt{29} \quad \cos \beta = -3/\sqrt{29} \quad \cos \gamma = -4/\sqrt{29}$
18. Let $\mathbf{u} = \alpha\mathbf{i} + \alpha\mathbf{j} + \alpha\mathbf{k}$. As \mathbf{u} is a unit vector, we must have $3\alpha^2 = 1$. Since the direction angles are between 0 and $\pi/2$, then $\alpha = 1/\sqrt{3}$.
19. $12[(1/\sqrt{3})\mathbf{i} + (1/\sqrt{3})\mathbf{j} + (1/\sqrt{3})\mathbf{k}] = 4\sqrt{3}\mathbf{i} + 4\sqrt{3}\mathbf{j} + 4\sqrt{3}\mathbf{k}$
20. $\cos^2 \frac{\pi}{6} + \cos^2 \frac{\pi}{3} + \cos^2 \frac{\pi}{4} = \frac{3}{4} + \frac{1}{4} + \frac{1}{2} = \frac{3}{2} \neq 1$.
21. $\overrightarrow{PQ} = (1, -3, 4) \quad |\overrightarrow{PQ}| = \sqrt{26} \quad \overrightarrow{PQ}/|\overrightarrow{PQ}| = (1/\sqrt{26}, -3/\sqrt{26}, 4/\sqrt{26})$
22. $\overrightarrow{PQ} = (11, 0, 0) \quad \mathbf{u} = (-1, 0, 0)$
23. Let $R = (a, b, c)$. Then $\overrightarrow{PR} = (a+3, b-1, c-7)$. We want $\overrightarrow{PR} \cdot \overrightarrow{PQ} = (a+3) = 0$. It follows that b and c are arbitrary and $a = -3$. Hence, all points of the form $(-3, b, c)$ satisfy the condition.
24. $|\overrightarrow{PR}| = 1$ implies $(b-1)^2 + (c-7)^2 = 1$, the equation of a circle.

25. By theorem 2, if \mathbf{u} and \mathbf{v} are two nonzero vectors then $\mathbf{u} \cdot \mathbf{v} \leq |\mathbf{u}||\mathbf{v}|$. If $\mathbf{u} = 0$ or $\mathbf{v} = 0$, then $\mathbf{u} \cdot \mathbf{v} = |\mathbf{u}||\mathbf{v}|$. Hence, for all vectors \mathbf{u} and \mathbf{v} , we have $\mathbf{u} \cdot \mathbf{v} \leq |\mathbf{u}||\mathbf{v}|$. Then

$$\begin{aligned} |\mathbf{u} + \mathbf{v}|^2 &= (\mathbf{u} + \mathbf{v}) \cdot (\mathbf{u} + \mathbf{v}) = |\mathbf{u}|^2 + 2\mathbf{u} \cdot \mathbf{v} + |\mathbf{v}|^2 \\ &\leq |\mathbf{u}|^2 + 2|\mathbf{u}||\mathbf{v}| + |\mathbf{v}|^2 = (|\mathbf{u}| + |\mathbf{v}|)^2 \end{aligned}$$

Taking square roots, we obtain $|\mathbf{u} + \mathbf{v}| \leq |\mathbf{u}| + |\mathbf{v}|$.

26. By the proof in problem 25, we will have equality if and only if $\mathbf{u} \cdot \mathbf{v} = |\mathbf{u}||\mathbf{v}|$. Suppose $\mathbf{v} \neq 0$ and $\mathbf{u} \neq 0$. By theorem 2, $\mathbf{u} \cdot \mathbf{v} = |\mathbf{u}||\mathbf{v}|$ if and only if $\varphi = 0$. Using part (i) of theorem 3, we have $\mathbf{u} \cdot \mathbf{v} = |\mathbf{u}||\mathbf{v}|$ if and only if $\mathbf{v} = \alpha\mathbf{u}$ for some $\alpha > 0$. We conclude that for all vectors \mathbf{u} and \mathbf{v} , $\mathbf{u} \cdot \mathbf{v} = |\mathbf{u}||\mathbf{v}|$ if and only if $\mathbf{u} = \alpha\mathbf{v}$ or $\mathbf{v} = \alpha\mathbf{u}$ for some $\alpha \geq 0$. Thus $|\mathbf{u} + \mathbf{v}| = |\mathbf{u}| + |\mathbf{v}|$ if and only if one of \mathbf{u} , \mathbf{v} is a nonnegative scalar multiple of the other.

27. $-6\mathbf{j} + 9\mathbf{k}$

28. $10\mathbf{i} + 3\mathbf{j} - 7\mathbf{k}$

29. $8\mathbf{i} - 14\mathbf{j} + 9\mathbf{k}$

30. $-13\mathbf{i} + 28\mathbf{j} + 12\mathbf{k}$

31. $16\mathbf{i} + 29\mathbf{j} + 42\mathbf{k}$

32. $2 \cdot (-2) + (-3) \cdot (-3) + 4 \cdot 5 = 25$

33. $\sqrt{1^2 + (-7)^2 + 3^2} = \sqrt{59}$

34. $35 - (-10) = 45$

35. $\varphi = \cos^{-1} \frac{\mathbf{u} \cdot \mathbf{w}}{|\mathbf{u}||\mathbf{w}|} = \cos^{-1} \frac{35}{\sqrt{29}\sqrt{59}} \approx 0.5621$

36. $\varphi = \cos^{-1} \frac{\mathbf{t} \cdot \mathbf{w}}{|\mathbf{t}||\mathbf{w}|} = \cos^{-1} \frac{-10}{5\sqrt{2}\sqrt{59}} \approx 1.7560$

37. $\text{proj}_{\mathbf{u}} \mathbf{v} = \frac{\mathbf{v} \cdot \mathbf{u}}{|\mathbf{u}|^2} \mathbf{u} = \frac{25}{(\sqrt{29})^2} (2\mathbf{i} - 3\mathbf{j} + 4\mathbf{k}) = \frac{50}{29}\mathbf{i} - \frac{75}{29}\mathbf{j} + \frac{100}{29}\mathbf{k}$

38. $\text{proj}_{\mathbf{t}} \mathbf{w} = \frac{\mathbf{w} \cdot \mathbf{t}}{|\mathbf{t}|^2} \mathbf{t} = \frac{-10}{(5\sqrt{2})^2} (3\mathbf{i} + 4\mathbf{j} + \mathbf{k}) = -\frac{3}{5}\mathbf{i} - \frac{4}{5}\mathbf{j} - \mathbf{k}$

39. We have $\overline{QR} = |z_1 - z_2|$, $\overline{RS} = |x_1 - x_2|$, and $\overline{PS} = |y_1 - y_2|$. By the Pythagorean theorem, $\overline{PR} = \sqrt{(x_1 - x_2)^2 + (y_1 - y_2)^2}$. Applying the Pythagorean theorem again to $\triangle PRQ$ gives

$$\overline{PQ} = \sqrt{(x_1 - x_2)^2 + (y_1 - y_2)^2 + (z_1 - z_2)^2}.$$

40. By the law of cosines, $|\mathbf{u} - \mathbf{v}|^2 = |\mathbf{u}|^2 + |\mathbf{v}|^2 - 2|\mathbf{u}||\mathbf{v}| \cos \varphi$. Since $|\mathbf{u} - \mathbf{v}|^2 = |\mathbf{u}|^2 - 2\mathbf{u} \cdot \mathbf{v} + |\mathbf{v}|^2$, then

$$\cos \varphi = \frac{\mathbf{u} \cdot \mathbf{v}}{|\mathbf{u}||\mathbf{v}|}.$$

41. (i) Suppose \mathbf{u} and \mathbf{v} are parallel. As $\frac{\mathbf{v}}{|\mathbf{v}|} = \pm \frac{\mathbf{u}}{|\mathbf{u}|}$, then $\mathbf{v} = \pm \frac{|\mathbf{v}|}{|\mathbf{u}|} \mathbf{u}$. Conversely, suppose $\mathbf{v} = \alpha\mathbf{u}$ for

some $\alpha \neq 0$. By theorem 2, $\cos \varphi = \frac{\mathbf{u} \cdot \mathbf{v}}{|\mathbf{u}||\mathbf{v}|} = \frac{\mathbf{u} \cdot (\alpha\mathbf{u})}{|\mathbf{u}||\alpha\mathbf{u}|} = \frac{\alpha\mathbf{u} \cdot \mathbf{u}}{|\alpha||\mathbf{u}|^2} = \pm 1$. Hence, φ is 0 or π . By

definition, \mathbf{u} and \mathbf{v} are parallel.

- (ii) By theorem 2, \mathbf{u} and \mathbf{v} are orthogonal if and only if $\mathbf{u} \cdot \mathbf{v} = 0$.

42. $\mathbf{w} \cdot \mathbf{v} = \mathbf{u} \cdot \mathbf{v} - \frac{\mathbf{u} \cdot \mathbf{v}}{|\mathbf{v}|^2} (\mathbf{v} \cdot \mathbf{v}) = \mathbf{u} \cdot \mathbf{v} - \mathbf{u} \cdot \mathbf{v} = 0$. Thus, \mathbf{w} and \mathbf{v} are orthogonal.

CALCULATOR SOLUTIONS 3.3

The problems in this section parallel those in Sections 3.1 and 3.2, and ask you to compute magnitudes, directions and projections for vectors in space. For a vector in space the magnitude is computed using the `NORM` function and the direction is computed by use of the `UNITV` function. The projection formula is computed as explained in the Section 3.2 solutions.

43. `NORM A3343` yields .707129874917 and `UNITV A3343` yields
 [.327521164379 .590980546606 -.737205453328]
44. `NORM A3344` yields 9141.97861516 and `UNITV A3344` yields
 [-.257712263305 -.89630487501 .360862799934]
45. `NORM A3345` yields 85.2279883606 and `UNITV A3345` yields
 [.20298496225 .91988560927 .335570515627]
46. `NORM A3346` yields .051603197575 and `UNITV A3346` yields
 [.263549559698 -.420516576871 -.868163255476]
47. `DOT (U3347, V3347) / DOT (V3347, V3347) * V3347` yields the projection (of U3347 onto V3347): [-18.3995893751 -16.8662902605 11.1711792634]. (As an alternate, you can enter `UNITV V3347` `DOT (U3347, Ans) * Ans` to get the same answer.)
48. `DOT (U3348, V3348) / DOT (V3348, V3348) * V3348` yields the projection:
 [.298598828242 -.468401643528 -.417576311062].
49. `DOT (U3349, V3349) / DOT (V3349, V3349) * V3349` yields the projection:
 [57.4451474781 271.495923758 310.507180628].
50. `DOT (U3350, V3350) / DOT (V3350, V3350) * V3350` yields the projection:
 [.138911953971 -.101026875615 .058406162465].

Section 3.4

$$1. \mathbf{u} \times \mathbf{v} = \begin{vmatrix} \mathbf{i} & \mathbf{j} & \mathbf{k} \\ 1 & -2 & 0 \\ 0 & 0 & 3 \end{vmatrix} = -6\mathbf{i} - 3\mathbf{j}$$

$$2. \mathbf{u} \times \mathbf{v} = \begin{vmatrix} \mathbf{i} & \mathbf{j} & \mathbf{k} \\ 3 & -7 & 0 \\ 1 & 0 & 1 \end{vmatrix} = -7\mathbf{i} - 3\mathbf{j} + 7\mathbf{k}$$

$$3. \mathbf{u} \times \mathbf{v} = \begin{vmatrix} \mathbf{i} & \mathbf{j} & \mathbf{k} \\ 1 & -1 & 0 \\ 0 & 1 & 1 \end{vmatrix} = -\mathbf{i} - \mathbf{j} + \mathbf{k}$$

$$4. \mathbf{u} \times \mathbf{v} = \begin{vmatrix} \mathbf{i} & \mathbf{j} & \mathbf{k} \\ 0 & 0 & -7 \\ 0 & 1 & 2 \end{vmatrix} = 7\mathbf{i}$$

$$5. \mathbf{u} \times \mathbf{v} = \begin{vmatrix} \mathbf{i} & \mathbf{j} & \mathbf{k} \\ -2 & 3 & 0 \\ 7 & 0 & 4 \end{vmatrix} = 12\mathbf{i} + 8\mathbf{j} - 21\mathbf{k}$$

$$6. \mathbf{u} \times \mathbf{v} = \begin{vmatrix} \mathbf{i} & \mathbf{j} & \mathbf{k} \\ a & b & 0 \\ c & d & 0 \end{vmatrix} = (ad - bc)\mathbf{k}$$

$$7. \mathbf{u} \times \mathbf{v} = \begin{vmatrix} \mathbf{i} & \mathbf{j} & \mathbf{k} \\ a & 0 & b \\ c & 0 & d \end{vmatrix} = (bc - ad)\mathbf{j}$$

$$8. \mathbf{u} \times \mathbf{v} = \begin{vmatrix} \mathbf{i} & \mathbf{j} & \mathbf{k} \\ 0 & a & b \\ c & 0 & d \end{vmatrix} = adi + bcj - ack$$

$$9. \mathbf{u} \times \mathbf{v} = \begin{vmatrix} \mathbf{i} & \mathbf{j} & \mathbf{k} \\ 2 & -3 & 1 \\ 1 & 2 & 1 \end{vmatrix} = -5\mathbf{i} - \mathbf{j} + 7\mathbf{k}$$

$$10. \mathbf{u} \times \mathbf{v} = \begin{vmatrix} \mathbf{i} & \mathbf{j} & \mathbf{k} \\ 3 & -4 & 2 \\ 6 & -3 & 5 \end{vmatrix} = -14\mathbf{i} - 3\mathbf{j} + 15\mathbf{k}$$

$$11. \mathbf{u} \times \mathbf{v} = \begin{vmatrix} \mathbf{i} & \mathbf{j} & \mathbf{k} \\ -3 & -2 & 1 \\ 6 & 4 & -2 \end{vmatrix} = 0\mathbf{i} + 0\mathbf{j} + 0\mathbf{k}$$

$$12. \mathbf{u} \times \mathbf{v} = \begin{vmatrix} \mathbf{i} & \mathbf{j} & \mathbf{k} \\ 1 & 7 & -3 \\ -1 & -7 & 3 \end{vmatrix} = 0\mathbf{i} + 0\mathbf{j} + 0\mathbf{k}$$

$$13. \mathbf{u} \times \mathbf{v} = \begin{vmatrix} \mathbf{i} & \mathbf{j} & \mathbf{k} \\ 1 & -7 & -3 \\ -1 & 7 & -3 \end{vmatrix} = 42\mathbf{i} + 6\mathbf{j}$$

$$14. \mathbf{u} \times \mathbf{v} = \begin{vmatrix} \mathbf{i} & \mathbf{j} & \mathbf{k} \\ 2 & -3 & 5 \\ 3 & -1 & -1 \end{vmatrix} = 8\mathbf{i} + 17\mathbf{j} + 7\mathbf{k}$$

$$15. \mathbf{u} \times \mathbf{v} = \begin{vmatrix} \mathbf{i} & \mathbf{j} & \mathbf{k} \\ 10 & 7 & -3 \\ -3 & 4 & -3 \end{vmatrix} = -9\mathbf{i} + 39\mathbf{j} + 61\mathbf{k}$$

$$16. \mathbf{u} \times \mathbf{v} = \begin{vmatrix} \mathbf{i} & \mathbf{j} & \mathbf{k} \\ 2 & 4 & -6 \\ -1 & -1 & 3 \end{vmatrix} = 6\mathbf{i} + 2\mathbf{k}$$

$$17. \mathbf{u} \times \mathbf{v} = \begin{vmatrix} \mathbf{i} & \mathbf{j} & \mathbf{k} \\ 2 & -1 & 1 \\ 4 & 2 & 2 \end{vmatrix} = -4\mathbf{i} + 8\mathbf{k}$$

$$18. \mathbf{u} \times \mathbf{v} = \begin{vmatrix} \mathbf{i} & \mathbf{j} & \mathbf{k} \\ 3 & -1 & 8 \\ 1 & 1 & -4 \end{vmatrix} = -4\mathbf{i} + 20\mathbf{j} + 4\mathbf{k}$$

$$19. \mathbf{u} \times \mathbf{v} = \begin{vmatrix} \mathbf{i} & \mathbf{j} & \mathbf{k} \\ a & a & a \\ b & b & b \end{vmatrix} = 0\mathbf{i} + 0\mathbf{j} + 0\mathbf{k}$$

$$20. \mathbf{u} \times \mathbf{v} = \begin{vmatrix} \mathbf{i} & \mathbf{j} & \mathbf{k} \\ a & b & c \\ a & b & -c \end{vmatrix} = -2bci + 2acj$$

$$21. \mathbf{u} \times \mathbf{v} = \begin{vmatrix} \mathbf{i} & \mathbf{j} & \mathbf{k} \\ 2 & -3 & 0 \\ 0 & 4 & 3 \end{vmatrix} = -9\mathbf{i} - 6\mathbf{j} + 8\mathbf{k}; |\mathbf{u} \times \mathbf{v}| = \sqrt{181}$$

$$\mathbf{u}_1 = \frac{-9}{\sqrt{181}}\mathbf{i} - \frac{6}{\sqrt{181}}\mathbf{j} + \frac{8}{\sqrt{181}}\mathbf{k}; \mathbf{u}_2 = \frac{9}{\sqrt{181}}\mathbf{i} + \frac{6}{\sqrt{181}}\mathbf{j} - \frac{8}{\sqrt{181}}\mathbf{k} = -\mathbf{u}_1$$

$$22. \mathbf{u} \times \mathbf{v} = \begin{vmatrix} \mathbf{i} & \mathbf{j} & \mathbf{k} \\ 1 & 1 & 1 \\ 1 & -1 & -1 \end{vmatrix} = 2\mathbf{j} - 2\mathbf{k}; |\mathbf{u} \times \mathbf{v}| = \sqrt{8} = 2\sqrt{2}$$

$$\mathbf{u}_1 = \frac{1}{\sqrt{2}}\mathbf{j} - \frac{1}{\sqrt{2}}\mathbf{k}; \mathbf{u}_2 = \frac{-1}{\sqrt{2}}\mathbf{j} + \frac{1}{\sqrt{2}}\mathbf{k} = -\mathbf{u}_1$$

$$23. \mathbf{u} \times \mathbf{v} = \begin{vmatrix} \mathbf{i} & \mathbf{j} & \mathbf{k} \\ 2 & 1 & -1 \\ -3 & -2 & 4 \end{vmatrix} = 2\mathbf{i} - 5\mathbf{j} - \mathbf{k}; |\mathbf{u} \times \mathbf{v}| = \sqrt{4 + 25 + 1} = \sqrt{30}$$

$$|\mathbf{u}| = \sqrt{4 + 1 + 1} = \sqrt{6}; |\mathbf{v}| = \sqrt{9 + 4 + 16} = \sqrt{29}$$

$$\sin \varphi = \frac{\sqrt{30}}{\sqrt{6}\sqrt{29}} = \sqrt{\frac{5}{29}}$$

$$24. \mathbf{u} \cdot \mathbf{v} = -6 - 2 - 4 = -12; \cos \varphi = \frac{-12}{\sqrt{174}}$$

$$\sin^2 \varphi + \cos^2 \varphi = 5/29 + 144/174 = (30 + 144)/174 = 1$$

$$25. \mathbf{u} = -\mathbf{i} - 2\mathbf{j} + 2\mathbf{k}; \mathbf{v} = -2\mathbf{i} - 4\mathbf{j} - \mathbf{k}$$

$$\mathbf{u} \times \mathbf{v} = \begin{vmatrix} \mathbf{i} & \mathbf{j} & \mathbf{k} \\ -1 & -2 & 2 \\ -2 & -4 & -1 \end{vmatrix} = -6\mathbf{i} - 5\mathbf{j} - 8\mathbf{k}; |\mathbf{u} \times \mathbf{v}| = \sqrt{36 + 25 + 64} = 5\sqrt{5} = \text{Area}$$

$$26. \mathbf{u} = -4\mathbf{i} - \mathbf{j} - 2\mathbf{k}; \mathbf{v} = -3\mathbf{i} - 4\mathbf{j} + \mathbf{k}$$

$$\mathbf{u} \times \mathbf{v} = \begin{vmatrix} \mathbf{i} & \mathbf{j} & \mathbf{k} \\ -4 & -1 & -2 \\ -3 & -4 & 1 \end{vmatrix} = -9\mathbf{i} + 10\mathbf{j} + 13\mathbf{k}; |\mathbf{u} \times \mathbf{v}| = \sqrt{81 + 100 + 169} = 5\sqrt{14} = \text{Area}$$

$$27. \mathbf{u} = -3\mathbf{i} - 3\mathbf{j} - 2\mathbf{k}; \mathbf{v} = -4\mathbf{i} - 3\mathbf{j} + 3\mathbf{k}$$

$$\mathbf{u} \times \mathbf{v} = \begin{vmatrix} \mathbf{i} & \mathbf{j} & \mathbf{k} \\ -3 & -3 & -2 \\ -4 & -3 & 3 \end{vmatrix} = -15\mathbf{i} + 17\mathbf{j} - 3\mathbf{k}; |\mathbf{u} \times \mathbf{v}| = \sqrt{225 + 289 + 9} = \sqrt{523} = \text{Area}$$

$$28. \mathbf{u} = 11\mathbf{i} - 3\mathbf{j} - 9\mathbf{k}; \mathbf{v} = 9\mathbf{i} - 3\mathbf{j} - 3\mathbf{k}$$

$$\mathbf{u} \times \mathbf{v} = \begin{vmatrix} \mathbf{i} & \mathbf{j} & \mathbf{k} \\ 11 & -3 & -9 \\ 9 & -3 & -3 \end{vmatrix} = -18\mathbf{i} - 48\mathbf{j} - 6\mathbf{k}; |\mathbf{u} \times \mathbf{v}| = \sqrt{324 + 2304 + 36} = 6\sqrt{74} = \text{Area}$$

$$29. \mathbf{u} = a\mathbf{i} - b\mathbf{j}; \mathbf{v} = -b\mathbf{j} + c\mathbf{k}$$

$$\mathbf{u} \times \mathbf{v} = \begin{vmatrix} \mathbf{i} & \mathbf{j} & \mathbf{k} \\ a & -b & 0 \\ 0 & -b & c \end{vmatrix} = -bci - acj - abk; |\mathbf{u} \times \mathbf{v}| = \sqrt{b^2c^2 + a^2c^2 + a^2b^2} = \text{Area}$$

$$30. \mathbf{u} = b\mathbf{j} - b\mathbf{k}; \mathbf{v} = -a\mathbf{i} + a\mathbf{j}$$

$$\mathbf{u} \times \mathbf{v} = \begin{vmatrix} \mathbf{i} & \mathbf{j} & \mathbf{k} \\ 0 & b & -b \\ -a & a & 0 \end{vmatrix} = abi - abj + abk; |\mathbf{u} \times \mathbf{v}| = \sqrt{a^2b^2 + a^2b^2 + a^2b^2} = |ab|\sqrt{3}$$

$$31. \text{ Let } \mathbf{u} = a\mathbf{i} + b\mathbf{j} + c\mathbf{k} \text{ and } \mathbf{v} = d\mathbf{i} + e\mathbf{j} + f\mathbf{k}.$$

$$\mathbf{u} \times \mathbf{v} = \begin{vmatrix} \mathbf{i} & \mathbf{j} & \mathbf{k} \\ a & b & c \\ d & e & f \end{vmatrix} = (bf - ce)\mathbf{i} + (cd - af)\mathbf{j} + (ae - bd)\mathbf{k}$$

$$|\mathbf{v}|^2 = d^2 + e^2 + f^2; (\mathbf{u} \cdot \mathbf{v})^2 = (ad + be + cf)^2$$

$$|\mathbf{u} \times \mathbf{v}|^2 = (ae - bd)^2 + (cd - af)^2 + (bf - ce)^2$$

$$= a^2e^2 - 2abde + b^2d^2 + c^2d^2 - 2acdf + a^2f^2 + b^2f^2 - 2bcef + c^2e^2$$

$$= (a^2 + b^2 + c^2)(d^2 + e^2 + f^2) - (ad + be + cf)^2$$

$$= |\mathbf{u}|^2|\mathbf{v}|^2 - (\mathbf{u} \cdot \mathbf{v})^2$$

32. Let $\mathbf{u} = ai + bj + ck$, $\mathbf{v} = di + ej + fk$ and $\mathbf{w} = li + mj + nk$.

$$\mathbf{u} \times \mathbf{0} = \begin{vmatrix} \mathbf{i} & \mathbf{j} & \mathbf{k} \\ a & b & c \\ 0 & 0 & 0 \end{vmatrix} = \mathbf{0} \text{ and } \mathbf{0} \times \mathbf{u} = \begin{vmatrix} \mathbf{i} & \mathbf{j} & \mathbf{k} \\ 0 & 0 & 0 \\ a & b & c \end{vmatrix} = \mathbf{0}, \text{ by property 1 of section 2.2.}$$

$$\mathbf{u} \times \mathbf{v} = \begin{vmatrix} \mathbf{i} & \mathbf{j} & \mathbf{k} \\ a & b & c \\ d & e & f \end{vmatrix} \text{ and } \mathbf{v} \times \mathbf{u} = \begin{vmatrix} \mathbf{i} & \mathbf{j} & \mathbf{k} \\ d & e & f \\ a & b & c \end{vmatrix}. \text{ Then by property 4 of section 2.2, } \mathbf{u} \times \mathbf{v} = -(\mathbf{v} \times \mathbf{u}).$$

$$(\alpha\mathbf{u}) \times \mathbf{v} = \begin{vmatrix} \mathbf{i} & \mathbf{j} & \mathbf{k} \\ \alpha a & \alpha b & \alpha c \\ d & e & f \end{vmatrix} = \alpha \begin{vmatrix} \mathbf{i} & \mathbf{j} & \mathbf{k} \\ a & b & c \\ d & e & f \end{vmatrix}, \text{ by property 2 of section 2.2.}$$

$$= \alpha(\mathbf{u} \times \mathbf{v})$$

$$\mathbf{u} \times (\mathbf{v} + \mathbf{w}) = \begin{vmatrix} \mathbf{i} & \mathbf{j} & \mathbf{k} \\ a & b & c \\ d+l & e+m & f+n \end{vmatrix} = \begin{vmatrix} \mathbf{i} & \mathbf{j} & \mathbf{k} \\ a & b & c \\ d & e & f \end{vmatrix} + \begin{vmatrix} \mathbf{i} & \mathbf{j} & \mathbf{k} \\ a & b & c \\ l & m & n \end{vmatrix}, \text{ by property 3 of section 2.2.}$$

$$= (\mathbf{u} \times \mathbf{v}) + (\mathbf{u} \times \mathbf{w})$$

33. Let $\mathbf{u} = ai + bj + ck$, $\mathbf{v} = di + ej + fk$ and $\mathbf{w} = li + mj + nk$.

$$\mathbf{u} \times \mathbf{v} = \begin{vmatrix} \mathbf{i} & \mathbf{j} & \mathbf{k} \\ a & b & c \\ d & e & f \end{vmatrix} = (bf - ce)\mathbf{i} + (cd - af)\mathbf{j} + (ae - bd)\mathbf{k}$$

$$(\mathbf{u} \times \mathbf{v}) \cdot \mathbf{w} = bfl - cel + cdm - afm + aen - bdn$$

$$\mathbf{v} \times \mathbf{w} = \begin{vmatrix} \mathbf{i} & \mathbf{j} & \mathbf{k} \\ d & e & f \\ l & m & n \end{vmatrix} = (en - fm)\mathbf{i} + (fl - dn)\mathbf{j} + (dm - el)\mathbf{k}$$

$$\mathbf{u} \cdot (\mathbf{v} \times \mathbf{w}) = aen - afm + bfl - bdn + cdm - cel. \text{ Then } (\mathbf{u} \times \mathbf{v}) \cdot \mathbf{w} = \mathbf{u} \cdot (\mathbf{v} \times \mathbf{w}).$$

34. $\mathbf{u} \cdot (\mathbf{u} \times \mathbf{v}) = \mathbf{u} \cdot (-\mathbf{v} \times \mathbf{u}) = -(\mathbf{u} \times \mathbf{v}) \cdot \mathbf{u} = -\mathbf{u} \cdot (\mathbf{u} \times \mathbf{v})$. Thus $\mathbf{u} \cdot (\mathbf{u} \times \mathbf{v}) = 0$.

$$\mathbf{v} \cdot (\mathbf{u} \times \mathbf{v}) = (\mathbf{v} \times \mathbf{u}) \cdot \mathbf{v} = -\mathbf{v} \cdot (\mathbf{u} \times \mathbf{v}). \text{ Thus } \mathbf{v} \cdot (\mathbf{u} \times \mathbf{v}) = 0.$$

35. If \mathbf{u} and \mathbf{v} are parallel and neither is $\mathbf{0}$, then $\mathbf{v} = t\mathbf{u}$ for some constant t . Then if $\mathbf{u} = ai + bj + ck$,

$$\mathbf{u} \times \mathbf{v} = \begin{vmatrix} \mathbf{i} & \mathbf{j} & \mathbf{k} \\ a & b & c \\ ta & tb & tc \end{vmatrix} = \mathbf{0} \text{ by property 6 of chapter 2.}$$

Conversely suppose that $\mathbf{u} \times \mathbf{v} = \mathbf{0}$ and neither \mathbf{u} nor \mathbf{v} is $\mathbf{0}$. Let φ be the angle between \mathbf{u} and \mathbf{v} . By theorem 3 $\sin \varphi = \frac{|\mathbf{u} \times \mathbf{v}|}{|\mathbf{u}||\mathbf{v}|} = \frac{0}{|\mathbf{u}||\mathbf{v}|} = 0$. Thus $\varphi = 0$ or π . Therefore \mathbf{u} and \mathbf{v} are parallel.

$$36. \mathbf{v} \times \mathbf{w} = \begin{vmatrix} \mathbf{i} & \mathbf{j} & \mathbf{k} \\ a_2 & b_2 & c_2 \\ a_3 & b_3 & c_3 \end{vmatrix} = \begin{vmatrix} b_2 & c_2 \\ b_3 & c_3 \end{vmatrix} \mathbf{i} - \begin{vmatrix} a_2 & c_2 \\ a_3 & c_3 \end{vmatrix} \mathbf{j} + \begin{vmatrix} a_2 & b_2 \\ a_3 & b_3 \end{vmatrix} \mathbf{k}$$

$$\begin{aligned} \mathbf{u} \cdot (\mathbf{v} \times \mathbf{w}) &= a_1 \begin{vmatrix} b_2 & c_2 \\ b_3 & c_3 \end{vmatrix} - b_1 \begin{vmatrix} a_2 & c_2 \\ a_3 & c_3 \end{vmatrix} + c_1 \begin{vmatrix} a_2 & b_2 \\ a_3 & b_3 \end{vmatrix} \\ &= \begin{vmatrix} a_1 & b_1 & c_1 \\ a_2 & b_2 & c_2 \\ a_3 & b_3 & c_3 \end{vmatrix} \end{aligned}$$

$$37. \begin{vmatrix} 1 & -1 & 0 \\ 3 & 0 & 2 \\ 0 & -7 & 3 \end{vmatrix} = 9 + 14 = 23; \text{ Volume} = 23$$

$$38. \begin{vmatrix} -5 & 0 & 5 \\ -3 & -1 & 3 \\ -5 & -2 & 6 \end{vmatrix} = 30 + 30 - 25 - 30 = 5; \text{ Volume} = 5$$

$$39. \text{ Let } \mathbf{u} = a\mathbf{i} + b\mathbf{j} + c\mathbf{k}, \mathbf{v} = d\mathbf{i} + e\mathbf{j} + f\mathbf{k}, \mathbf{w} = l\mathbf{i} + m\mathbf{j} + n\mathbf{k} \text{ and } A = \begin{vmatrix} a_{11} & a_{12} & a_{13} \\ a_{21} & a_{22} & a_{23} \\ a_{31} & a_{32} & a_{33} \end{vmatrix}.$$

Then the volume generated by $\mathbf{u}_1, \mathbf{v}_1, \mathbf{w}_1 = |(\mathbf{A}\mathbf{u} \times \mathbf{A}\mathbf{v}) \cdot \mathbf{A}\mathbf{w}|$

$$= \begin{vmatrix} a_{11}a + a_{12}b + a_{13}c & a_{21}a + a_{22}b + a_{23}c & a_{31}a + a_{32}b + a_{33}c \\ a_{11}d + a_{12}e + a_{13}f & a_{21}d + a_{22}e + a_{23}f & a_{31}d + a_{32}e + a_{33}f \\ a_{11}l + a_{12}m + a_{13}n & a_{21}l + a_{22}m + a_{23}n & a_{31}l + a_{32}m + a_{33}n \end{vmatrix} = \begin{vmatrix} a_{11} & a_{12} & a_{13} \\ a_{21} & a_{22} & a_{23} \\ a_{31} & a_{32} & a_{33} \end{vmatrix} \begin{vmatrix} a & b & c \\ d & e & f \\ l & m & n \end{vmatrix}$$

$$= (\pm \det A)(\text{volume generated by } \mathbf{u}, \mathbf{v} \text{ and } \mathbf{w})$$

$$40. \text{ (a) volume generated by } \mathbf{u}, \mathbf{v}, \mathbf{w} = \begin{vmatrix} 2 & -1 & 0 \\ 1 & 0 & 4 \\ -1 & 3 & 2 \end{vmatrix} = 18$$

$$\text{(b) } \mathbf{A}\mathbf{u} = \mathbf{i} + 9\mathbf{j} + 2\mathbf{k}; \mathbf{A}\mathbf{v} = 6\mathbf{i} + 24\mathbf{j} + 25\mathbf{k}; \mathbf{A}\mathbf{w} = 9\mathbf{i} + 3\mathbf{j} + 11\mathbf{k}$$

$$\text{volume generated by } \mathbf{A}\mathbf{u}, \mathbf{A}\mathbf{v}, \mathbf{A}\mathbf{w} = \begin{vmatrix} 1 & 9 & 2 \\ 6 & 24 & 25 \\ 9 & 3 & 11 \end{vmatrix} = 1224$$

$$\text{(c) } \det A = \begin{vmatrix} 2 & 3 & 1 \\ 4 & -1 & 5 \\ 1 & 0 & 6 \end{vmatrix} = -68$$

$$\text{(d) } 1224 = -(-68)(18)$$

$$41. \text{ Let } \mathbf{u} = a\mathbf{i} + b\mathbf{j} + c\mathbf{k}, \mathbf{v} = d\mathbf{i} + e\mathbf{j} + f\mathbf{k}, \text{ and } \mathbf{w} = l\mathbf{i} + m\mathbf{j} + n\mathbf{k}.$$

$$\mathbf{v} \times \mathbf{w} = \begin{vmatrix} \mathbf{i} & \mathbf{j} & \mathbf{k} \\ d & e & f \\ l & m & n \end{vmatrix} = (en - fm)\mathbf{i} + (fl - dn)\mathbf{j} + (dm - el)\mathbf{k}$$

$$\mathbf{u} \times (\mathbf{v} \times \mathbf{w}) = \begin{vmatrix} \mathbf{i} & \mathbf{j} & \mathbf{k} \\ a & b & c \\ en - fm & fl - dn & dm - el \end{vmatrix} = (bdm - bel - cfl + cdn)\mathbf{i}$$

$$+ (cen - cfm - adm + ael)\mathbf{j} + (afl - adn - ben + bfm)\mathbf{k}$$

$$= (d(bm + cn + al) - l(ad + be + cf))\mathbf{i}$$

$$+ (e(cn + al + bm) - m(cf + ad + be))\mathbf{j} + (f(al + bm + cn) - n(ad + be + cf))\mathbf{k}$$

$$= (\mathbf{u} \cdot \mathbf{w})\mathbf{v} - (\mathbf{u} \cdot \mathbf{v})\mathbf{w}$$

CALCULATOR SOLUTIONS 3.4

Cross products are computed on the TI-85 by use of the $\text{CROSS}(\text{vec1}, \text{vec2})$ function. As usual, our solutions assume the data for $\mathbf{u} \times \mathbf{v}$ have been entered into $U34nn$ and $V34nn$, although we note that the data for Problem nn in this section is exactly the same as the data for Section 3.3, Problem $nn + 5$, .e.g. we could use $U3347$ and $V3347$ in Problem 42, if we still had those vectors in the memory of the TI-85.

42. $\text{CROSS}(U3442, V3442)$ **ENTER** yields the cross product ($U3442 \times V3442$): [7768 -6207 3423].
43. $\text{CROSS}(U3443, V3443)$ **ENTER** yields the cross product: [.294473 .676166 -.547895].
44. $\text{CROSS}(U3444, V3444)$ **ENTER** yields the cross product: [-49765722 -45192844 48721811].
45. $\text{CROSS}(U3449, V3449)$ **ENTER** yields the cross product: [.004852 -.00404 -.018528].

MATLAB 3.4

1. For each pair of vectors, c is computed to be the cross product of u with v . Then $c \cdot u$ and $c \cdot v$ are computed to make sure that c is orthogonal to both u and v .

```

>> u = [1; -2; 0]; v = [0; 0; 3]; % For problem 1.
>>                                     % First, compute c = u x v:
>> c = [u(2)*v(3) - u(3)*v(2);u(3)*v(1) - u(1)*v(3);u(1)*v(2) - u(2)*v(1)]
c =
    -6
    -3
     0

>> c' * u                               % This should be zero.
ans =
     0

>> c' * v                               % This should also be zero.
ans =
     0

>> u = [3; -7; 0]; v = [1; 0; 1]; % For problem 2.
>>                                     % First, compute c = u x v:
>> c = [u(2)*v(3) - u(3)*v(2);u(3)*v(1) - u(1)*v(3);u(1)*v(2) - u(2)*v(1)]
c =
    -7
    -3
     7

>> c' * u                               % This should be zero.
ans =
     0

>> c' * v                               % This should also be zero.
ans =
     0

>> u = [1; -1; 0]; v = [0; 1; 1]; % For problem 3.
>>                                     % First, compute c = u x v:
>> c = [u(2)*v(3) - u(3)*v(2);u(3)*v(1) - u(1)*v(3);u(1)*v(2) - u(2)*v(1)]
c =
    -1
    -1
     1

>> c' * u                               % This should be zero.
ans =
     0

>> c' * v                               % This should also be zero.
ans =
     0

>> u = [0; 0; -7]; v = [0; 1; 2]; % For problem 4.
>>                                     % First, compute c = u x v:
>> c = [u(2)*v(3) - u(3)*v(2);u(3)*v(1) - u(1)*v(3);u(1)*v(2) - u(2)*v(1)]
c =
     7
     0
     0

```

```

>> c' * u                                % This should be zero.
ans =
    0

>> c' * v                                % This should also be zero.
ans =
    0

>> u = [-2; 3; 0]; v = [7; 0; 4]; % For problem 5.
>>                                     % First, compute c = u x v:
>> c = [u(2)*v(3) - u(3)*v(2);u(3)*v(1) - u(1)*v(3);u(1)*v(2) - u(2)*v(1)]
c =
    12
     8
   -21

>> c' * u                                % This should be zero.
ans =
    0

>> c' * v                                % This should also be zero.
ans =
    0

>> u = [3; -4; 2]; v = [6; -3; 5]; % For problem 10.
>>                                     % First, compute c = u x v:
>> c = [u(2)*v(3) - u(3)*v(2);u(3)*v(1) - u(1)*v(3);u(1)*v(2) - u(2)*v(1)]
c =
   -14
    -3
    15

>> c' * u                                % This should be zero.
ans =
    0

>> c' * v                                % This should also be zero.
ans =
    0

```

2. (a)

```

>> u = 2*rand(3,1)-1
u =
    0.0595
   -0.0711
    0.8820

>> v = 2*rand(3,1)-1
v =
   -0.8998
    0.5230
    0.5404

```

```

>> w = 2*rand(3,1)-1
w =
    0.6556
   -0.7493
   -0.9683

>>                                     % compute the cross product of v and w.
>> c = [v(2)*w(3) - v(3)*w(2);v(3)*w(1) - v(1)*w(3);v(1)*w(2) - v(2)*w(1)]
c =
   -0.1015
   -0.5170
    0.3313

>> s = u' * c                                     % s = u . (v x w)
s =
    0.3229

>> B = [u v w]
B =
    0.0595   -0.8998    0.6556
   -0.0711    0.5230   -0.7493
    0.8820    0.5404   -0.9683

>> det(B)
ans =
    0.3229

```

The scalar product and $\det(B)$ are the same. Proof: The determinant of B is

$$\begin{aligned}
 \det(B) &= u_1 v_2 w_3 + u_2 v_3 w_1 + u_3 v_1 w_3 - u_1 v_3 w_2 - u_2 v_1 w_3 - u_3 v_2 w_1 \\
 &= u_1(v_2 w_3 - v_3 w_2) + u_2(v_3 w_1 - v_1 w_3) + u_3(v_1 w_3 - v_2 w_1) \\
 &= (u_1, u_2, u_3) \cdot (v_2 w_3 - v_3 w_2, v_3 w_1 - v_1 w_3, v_1 w_3 - v_2 w_1) \\
 &= \mathbf{u} \cdot (\mathbf{v} \times \mathbf{w}).
 \end{aligned}$$

(b)

```

>> u = 2*rand(3,1)-1
u =
    0.3769
    0.7365
    0.2591

>> v = 2*rand(3,1)-1
v =
    0.4724
    0.4508
    0.9989

>> w = 2*rand(3,1)-1
w =
    0.7771
   -0.5336
   -0.3874

```

```

>> A = round( 10*(2*rand(3)-1))
A =
    -3     7    -5
     0    -2    -2
     2     7     1

>>                                     % From part (a), we can compute u.(v x w) by
>> B = [u v w];                         % using det(B).
>> s = abs( det(B))                     % This is |u x w|

s =
    0.6855

>> AB = [ (A*u) (A*v) (A*w) ]          % Use the same method for Au.(Av x Aw)
AB =
    2.7293   -3.2562   -4.1299
   -1.9912   -2.8995    1.8419
    6.1684    5.0996   -2.5683

>> ss = abs(det(AB))                    % This is |Au.(Av x Aw)|.

ss =
    57.5838

>> d = abs(det(A))
d =
     84

>> d*s                                     % Conjecture: d*s is the same as ss.
ans =
    57.5838

```

The above can be repeated, and in each case $|\mathbf{Au} \cdot (\mathbf{Av} \times \mathbf{Aw})|$ is the product of $|\det(A)|$ and $|\mathbf{u} \cdot (\mathbf{v} \times \mathbf{w})|$. Recall that $|\mathbf{u} \cdot (\mathbf{v} \times \mathbf{w})|$ is the volume of the parallelepiped determined by \mathbf{u} , \mathbf{v} and \mathbf{w} . This means that when we multiply the points in a parallelepiped by the matrix A , the volume of the new parallelepiped will be $|\det(A)|$ times the volume of the old parallelepiped. I.e., the matrix A will increase volumes by $|\det(A)|$.

- (c) From part (a), we know that $\mathbf{u} \cdot (\mathbf{v} \times \mathbf{w}) = \det([\mathbf{u} \ \mathbf{v} \ \mathbf{w}])$. If we replace \mathbf{u} , \mathbf{v} and \mathbf{w} by \mathbf{Au} , \mathbf{Av} and \mathbf{Aw} in this equation, we get $\mathbf{Au} \cdot (\mathbf{Av} \times \mathbf{Aw}) = \det([\mathbf{Au} \ \mathbf{Av} \ \mathbf{Aw}])$. From the definition of matrix multiplication, $AB = [\mathbf{Au} \ \mathbf{Av} \ \mathbf{Aw}]$. This, combined with the equality $\det(AB) = \det(A) \det(B)$, leads to $|\mathbf{Au} \cdot (\mathbf{Av} \times \mathbf{Aw})| = |\det(AB)| = |\det(A) \det(B)| = |\det(A)| |\det(B)| = |\det(A)| |\mathbf{u} \cdot (\mathbf{v} \times \mathbf{w})|$, which is the desired equality.

Section 3.5

1. $\mathbf{v} = (1 - 2)\mathbf{i} + (2 - 1)\mathbf{j} + (-1 - 3)\mathbf{k} = -\mathbf{i} + \mathbf{j} - 4\mathbf{k}$
 $x\mathbf{i} + y\mathbf{j} + z\mathbf{k} = 2\mathbf{i} + \mathbf{j} + 3\mathbf{k} + t(-\mathbf{i} + \mathbf{j} - 4\mathbf{k}); x = 2 - t, y = 1 + t,$
 $z = 3 - 4t; \frac{x - 2}{-1} = \frac{y - 1}{1} = \frac{z - 3}{-4}$
2. $\mathbf{v} = (-1 - 1)\mathbf{i} + (1 + 1)\mathbf{j} + (-1 - 1)\mathbf{k} = -2\mathbf{i} + 2\mathbf{j} - 2\mathbf{k}$
 $x\mathbf{i} + y\mathbf{j} + z\mathbf{k} = \mathbf{i} - \mathbf{j} + \mathbf{k} + t(-2\mathbf{i} + 2\mathbf{j} - 2\mathbf{k}); x = 1 - 2t, y = -1 + 2t,$
 $z = 1 - 2t; \frac{x - 1}{-2} = \frac{y + 1}{2} = \frac{z - 1}{-2}$
3. $\mathbf{v} = (-4 + 4)\mathbf{i} + (0 - 1)\mathbf{j} + (1 - 3)\mathbf{k} = -\mathbf{j} - 2\mathbf{k}$
 $x\mathbf{i} + y\mathbf{j} + z\mathbf{k} = -4\mathbf{i} + \mathbf{j} + 3\mathbf{k} + t(-\mathbf{j} - 2\mathbf{k}); x = -4, y = 1 - t, z = 3 - 2t;$
 $x = -4, \frac{y - 1}{-1} = \frac{z - 3}{2}$
4. $\mathbf{v} = (2 - 2)\mathbf{i} + (0 - 3)\mathbf{j} + (-4 + 4)\mathbf{k} = -3\mathbf{j}$
 $x\mathbf{i} + y\mathbf{j} + z\mathbf{k} = 2\mathbf{i} + 3\mathbf{j} - 4\mathbf{k} + t(-3\mathbf{j}); x = 2, y = 3 - 3t, z = -4;$
 $x = 2, z = -4$
5. $\mathbf{v} = (3 - 1)\mathbf{i} + (2 - 2)\mathbf{j} + (1 - 3)\mathbf{k} = 2\mathbf{i} - 2\mathbf{k}$
 $x\mathbf{i} + y\mathbf{j} + z\mathbf{k} = \mathbf{i} + 2\mathbf{j} + 3\mathbf{k} + t(2\mathbf{i} - 2\mathbf{k}); x = 1 + 2t, y = 2, z = 3 - 2t;$
 $\frac{x - 1}{2} = \frac{z - 3}{-2}, y = 2$
6. $\mathbf{v} = (-1 - 7)\mathbf{i} + (-2 - 1)\mathbf{j} + (3 - 3)\mathbf{k} = -8\mathbf{i} - 3\mathbf{j}$
 $x\mathbf{i} + y\mathbf{j} + z\mathbf{k} = 7\mathbf{i} + \mathbf{j} + 3\mathbf{k} + t(-8\mathbf{i} - 3\mathbf{j});$
 $x = 7 - 8t, y = 1 - 3t, z = 3; \frac{x - 7}{8} = \frac{y - 1}{-3}, z = 3$
7. $x\mathbf{i} + y\mathbf{j} + z\mathbf{k} = 2\mathbf{i} + 2\mathbf{j} + \mathbf{k} + t(2\mathbf{i} - \mathbf{j} - \mathbf{k}); x = 2 + 2t, y = 2 - t,$
 $z = 1 - t; \frac{x - 2}{2} = \frac{y - 2}{-1} = \frac{z - 1}{-1}$
8. $x\mathbf{i} + y\mathbf{j} + z\mathbf{k} = -\mathbf{i} - 6\mathbf{j} + 2\mathbf{k} + t(4\mathbf{i} + \mathbf{j} - 3\mathbf{k}); x = -1 + 4t, y = -6 + t, z = 2 - 3t; \frac{x + 1}{4} = \frac{y + 6}{1} = \frac{z - 2}{-3}$
9. $x\mathbf{i} + y\mathbf{j} + z\mathbf{k} = -\mathbf{i} - 2\mathbf{j} + 5\mathbf{k} + t(-3\mathbf{j} + 7\mathbf{k}); x = -1, y = -2 - 3t, z = 5 + 7t; x = -1, \frac{y + 2}{-3} = \frac{z - 5}{7}$
10. $x\mathbf{i} + y\mathbf{j} + z\mathbf{k} = -2\mathbf{i} + 3\mathbf{j} - 2\mathbf{k} + t(4\mathbf{k}); x = -2, y = 3, z = -2 + 4t; x = -2, y = 3$
11. $x\mathbf{i} + y\mathbf{j} + z\mathbf{k} = a\mathbf{i} + b\mathbf{j} + c\mathbf{k} + t(d\mathbf{i} + e\mathbf{j}); x = a + dt, y = b + et, z = c; \frac{x - a}{d} = \frac{y - b}{e}, z = c$
12. $x\mathbf{i} + y\mathbf{j} + z\mathbf{k} = a\mathbf{i} + b\mathbf{j} + c\mathbf{k} + t(d\mathbf{k}); x = a, y = b, z = c + dt; x = a, y = b$
13. $x\mathbf{i} + y\mathbf{j} + z\mathbf{k} = 4\mathbf{i} + \mathbf{j} - 6\mathbf{k} + t(3\mathbf{i} + 6\mathbf{j} + 2\mathbf{k}); x = 4 + 3t, y = 1 + 6t, z = -6 + 2t; \frac{x - 4}{3} = \frac{y - 1}{6} = \frac{z + 6}{2}$
14. $x\mathbf{i} + y\mathbf{j} + z\mathbf{k} = 3\mathbf{i} + \mathbf{j} - 2\mathbf{k} + t(3\mathbf{i} + 2\mathbf{j} - 4\mathbf{k}); x = 3 + 3t, y = 1 + 2t, z = -2 - 4t; \frac{x - 3}{3} = \frac{y - 1}{2} = \frac{z + 2}{-4}$
15. L_1 is parallel to $\mathbf{v}_1 = (a_1, b_1, c_1)$ and L_2 is parallel to $\mathbf{v}_2 = (a_2, b_2, c_2)$. Hence, L_1 is orthogonal to L_2 if and only if $\mathbf{v}_1 \cdot \mathbf{v}_2 = a_1a_2 + b_1b_2 + c_1c_2 = 0$.
16. $(2, 4, -1) \cdot (5, -2, 2) = 10 - 8 - 2 = 0$, using problem 15.
17. L_1 is parallel to $(1, 2, 3)$ and L_2 is parallel to $(3, 6, 9)$. Since $(3, 6, 9) = 3(1, 2, 3)$, the lines are parallel.

18. If $t = 1$ and $s = -5$, both sets of parametric equations give the point $(2, -1, -3)$. (Find t, s by solving 3 equations obtained by computing coordinates of L_1, L_2).
19. If the lines did have a point in common, we could find an s and t such that $2 - t = 1 + s$, $1 + t = -2s$, and $-2t = 3 + 2s$. Writing this system as an augmented matrix and solving gives $\left(\begin{array}{cc|c} -1 & -1 & -1 \\ 1 & 2 & -1 \\ -2 & -2 & 3 \end{array}\right) \rightarrow \left(\begin{array}{cc|c} 1 & 1 & 1 \\ 0 & 1 & -2 \\ 0 & 0 & 5 \end{array}\right)$. Thus the lines do not have a point in common since the system is inconsistent.

20. We want a t such that $\vec{OR} \cdot \mathbf{v} = (\vec{OP} + t\mathbf{v}) \cdot \mathbf{v} = 0$. Solving for t gives $t = -\frac{\vec{OP} \cdot \mathbf{v}}{|\mathbf{v}|^2}$.

21. (a) $t = -\frac{(2, 1, -4) \cdot (1, 1, 1)}{3} = \frac{1}{3}$; $\vec{OR} = (2, 1, -4) + \frac{1}{3}(1, 1, 1) = (7/3, 4/3, -11/3)$; $|\vec{OR}| = \frac{\sqrt{186}}{3}$
 (b) $t = -\frac{(1, 2, -3) \cdot (3, -1, -1)}{11} = -\frac{4}{11}$; $\vec{OR} = (1, 2, -3) - \frac{4}{11}(3, -1, -1) = (-1/11, 26/11, -29/11)$;
 $|\vec{OR}| = \frac{\sqrt{1518}}{11}$
 (c) $t = -\frac{(-1, 4, 2) \cdot (-1, 1, 2)}{6} = -\frac{3}{2}$; $\vec{OR} = (-1, 4, 2) - \frac{3}{2}(-1, 1, 2) = (1/2, 5/2, -1)$; $|\vec{OR}| = \frac{\sqrt{30}}{2}$

22. We want $\mathbf{v} = (a, b, c)$ such that $\mathbf{v} \cdot (-3, 4, -5) = 0$ and $\mathbf{v} \cdot (7, -2, 3) = 0$. This gives the following system $\left(\begin{array}{ccc|c} -3 & 4 & -5 & 0 \\ 7 & -2 & 3 & 0 \end{array}\right) \rightarrow \left(\begin{array}{ccc|c} 1 & 6 & -7 & 0 \\ 0 & 11 & -13 & 0 \end{array}\right)$. Let $c = 11$. Then $b = 13$ and $a = -1$. Hence the line $\frac{x-1}{-1} = \frac{y+3}{13} = \frac{z-2}{11}$ satisfies the conditions.

23. We want $\mathbf{v} = (a, b, c)$ such that $\mathbf{v} \cdot (-4, -7, 3) = 0$ and $\mathbf{v} \cdot (3, -4, -2) = 0$. This gives the system $\left(\begin{array}{ccc|c} -4 & -7 & 3 & 0 \\ 3 & -4 & -2 & 0 \end{array}\right) \rightarrow \left(\begin{array}{ccc|c} 1 & 11 & -1 & 0 \\ 0 & 37 & -1 & 0 \end{array}\right)$. If we let $c = 37$, then $b = 1$ and $a = 26$. So the line $\frac{x+4}{26} = \frac{y-7}{1} = \frac{z-3}{37}$ satisfies the conditions.

24. As in the previous problems, we have $\left(\begin{array}{ccc|c} -2 & 3 & 5 & 0 \\ 4 & -2 & 1 & 0 \end{array}\right) \rightarrow \left(\begin{array}{ccc|c} 2 & 1 & 6 & 0 \\ 0 & 4 & 11 & 0 \end{array}\right)$. If we let $c = 8$, then $b = -22$ and $a = -13$. Hence the line $x = -2 - 13t$, $y = 3 - 22t$, $z = 4 + 8t$ satisfies the conditions.

25. $\left(\begin{array}{ccc|c} 10 & -8 & 7 & 0 \\ -2 & 4 & -3 & 0 \end{array}\right) \rightarrow \left(\begin{array}{ccc|c} -2 & 1 & -1 & 0 \\ 0 & 3 & -2 & 0 \end{array}\right)$. Let $c = 24$. Then $b = 16$ and $a = -4$. Thus the line $x = 4 - 4t$, $y = 6 + 16t$, $z = 24t$ satisfies the conditions.

26. Let $\mathbf{v} = (a, b, c)$. $\mathbf{v} \cdot (3, 2, -1) = 0$ and $\mathbf{v} \cdot (-4, 4, 1) = 0$ gives $\left(\begin{array}{ccc|c} 3 & 2 & -1 & 0 \\ -4 & 4 & 1 & 0 \end{array}\right) \rightarrow \left(\begin{array}{ccc|c} 1 & -6 & 0 & 0 \\ 0 & 20 & -1 & 0 \end{array}\right)$.

If we let $c = 20$, then $b = 1$ and $a = 6$. Thus $\mathbf{v} = (6, 1, 20)$ is perpendicular to both L_1 and L_2 . The point $P = (2, 5, 1)$ is on L_1 and the point $Q = (4, 5, -2)$ is on L_2 . So the distance between L_1 and L_2 is given by

$$|\text{proj}_{\mathbf{v}} \vec{PQ}| = \left| \frac{\vec{PQ} \cdot \mathbf{v}}{|\mathbf{v}|^2} \mathbf{v} \right| = \frac{|\vec{PA} \cdot \mathbf{v}|}{|\mathbf{v}|} = \frac{48}{\sqrt{457}}.$$

27. Let $\mathbf{v} = (a, b, c)$. $\mathbf{v} \cdot (3, -4, 4) = 0$ and $\mathbf{v} \cdot (-3, 4, 1) = 0$ gives $\left(\begin{array}{ccc|c} 3 & -4 & 4 & 0 \\ -3 & 4 & 1 & 0 \end{array} \right) \rightarrow \left(\begin{array}{ccc|c} 3 & -4 & 0 & 0 \\ 0 & 0 & 1 & 0 \end{array} \right)$.

Let $b = 3$. Then $\mathbf{v} = (4, 3, 0)$ is perpendicular to both L_1 and L_2 . The point $P = (-2, 7, 2)$ is on L_1 and the point $Q = (1, -2, -1)$ is on L_2 . So the distance between L_1 and L_2 is given by $|\text{proj}_{\mathbf{v}} \vec{PQ}| =$

$$\left| \frac{\vec{PQ} \cdot \mathbf{v}}{|\mathbf{v}|^2} \mathbf{v} \right| = \frac{|\vec{PQ} \cdot \mathbf{v}|}{|\mathbf{v}|} = \frac{15}{5} = 3.$$

Use $(\mathbf{x} - \vec{OP}) \cdot \mathbf{n} = 0$ in 28–37.

28. $1(x - 0) + 0(y - 0) + 0(z - 0) = 0$; $x = 0$ 29. $y = 0$ 30. $z = 0$

31. $1(x - 1) + 1(y - 2) + 0(z - 3) = 0$; $x + y = 3$

32. $1(x - 1) + 0(y - 2) + 1(z - 3) = 0$; $x + z = 4$

33. $0(x - 1) + 1(y - 2) + 1(z - 3) = 0$; $y + z = 5$

34. $3(x - 2) - (y + 1) + 2(z - 6) = 0$; $3x - y + 2z = 19$

35. $-3(x + 4) - 4(y + 7) + (z - 5) = 0$; $-3x - 4y + z = 45$

36. $4(x + 3) + (y - 11) - 7(z - 2) = 0$; $4x + y - 7z = -15$

37. $2(x - 3) - 7(y + 2) - 8(z - 5) = 0$; $2x - 7y - 8z = -20$

38. Let $P = (1, 2, -4)$, $Q = (2, 3, 7)$, and $R = (4, -1, 3)$. Then $\vec{PQ} = (1, 1, 11)$, $\vec{QR} = (2, -4, -4)$, and

$$\mathbf{n} = \vec{PQ} \times \vec{QR} = \begin{vmatrix} \mathbf{i} & \mathbf{j} & \mathbf{k} \\ 1 & 1 & 11 \\ 2 & -4 & -4 \end{vmatrix} = 40\mathbf{i} + 26\mathbf{j} - 6\mathbf{k}. \text{ Thus } \pi \text{ is given by } 40(x - 1) + 26(y - 2) - 6(z + 4) = 0,$$

which simplifies to $20x + 13y - 3z = 58$.

39. Let $P = (-7, 1, 0)$, $Q = (2, -1, 3)$, and $R = (4, 1, 6)$. Then $\vec{PQ} = (9, -2, 3)$, $\vec{QR} = (2, 2, 3)$, and

$$\mathbf{n} = \vec{PQ} \times \vec{QR} = \begin{vmatrix} \mathbf{i} & \mathbf{j} & \mathbf{k} \\ 9 & -2 & 3 \\ 2 & 2 & 3 \end{vmatrix} = -12\mathbf{i} - 21\mathbf{j} + 22\mathbf{k}. \text{ Hence } \pi \text{ is given by } -12(x + 7) - 21(y - 1) + 22(z - 0) = 0,$$

which simplifies to $-12x - 21y + 22z = 63$.

40. Let $P = (1, 0, 0)$, $Q = (0, 1, 0)$, and $R = (0, 0, 1)$. As before, compute \vec{PQ} and \vec{QR} to find $\mathbf{n} =$

$$\vec{PQ} \times \vec{QR} = \begin{vmatrix} \mathbf{i} & \mathbf{j} & \mathbf{k} \\ -1 & 1 & 0 \\ 0 & -1 & 1 \end{vmatrix} = \mathbf{i} + \mathbf{j} + \mathbf{k}. \text{ Thus } \pi \text{ is given by } (x - 1) + y + z = 0, \text{ which simplifies to}$$

$x + y + z = 1$.

41. Let $P = (2, 3, -2)$, $Q = (4, -1, -1)$, and $R = (3, 1, 2)$. Compute \vec{PQ} and \vec{QR} to find $\mathbf{n} = \vec{PQ} \times \vec{QR} = -14\mathbf{i} - 7\mathbf{j}$. Then π is given by the equation $2x + y = 7$.

42. Since the equations are equivalent, π_1 and π_2 are coincident.

43. Since the equations are equivalent, π_1 and π_2 are coincident.

44. $\mathbf{n}_1 = 2\mathbf{i} - \mathbf{j} + \mathbf{k}$ and $\mathbf{n}_2 = \mathbf{i} + \mathbf{j} - \mathbf{k}$. $\mathbf{n}_1 \cdot \mathbf{n}_2 = 0$. Thus π_1 and π_2 are orthogonal.

45. $\mathbf{n}_1 = 2\mathbf{i} - \mathbf{j} + \mathbf{k}$ and $\mathbf{n}_2 = \mathbf{i} + \mathbf{j} + \mathbf{k}$. As $\mathbf{n}_1 \cdot \mathbf{n}_2 = 3 \neq 0$, π_1 and π_2 are not orthogonal. Since $\mathbf{n}_1 \neq \alpha \mathbf{n}_2$ for any $\alpha \neq 0$, π_1 and π_2 are not parallel.

46. $\mathbf{n}_1 = 3\mathbf{i} - 2\mathbf{j} + 7\mathbf{k}$ and $\mathbf{n}_2 = -2\mathbf{i} + 4\mathbf{j} + 2\mathbf{k}$. As $\mathbf{n}_1 \cdot \mathbf{n}_2 = 0$, π_1 and π_2 are orthogonal.

47. $\left(\begin{array}{ccc|c} 1 & -1 & 1 & 2 \\ 2 & -3 & 4 & 7 \end{array}\right) \rightarrow \left(\begin{array}{ccc|c} 1 & 0 & -1 & -1 \\ 0 & 1 & -2 & -3 \end{array}\right)$. If we let $z = t$, then the line of intersection is given by $x = -1 + t$, $y = -3 + 2t$, and $z = t$.

48. $\left(\begin{array}{ccc|c} 3 & -1 & 4 & 3 \\ -4 & -2 & 7 & 8 \end{array}\right) \rightarrow \left(\begin{array}{ccc|c} 1 & 3 & -11 & -11 \\ 0 & -10 & 37 & 36 \end{array}\right)$. Let $z = t$, then the line of intersection is given by $x = -\frac{1}{5} - \frac{1}{10}t$, $y = -\frac{18}{5} + \frac{37}{10}t$, and $z = t$.

49. $\left(\begin{array}{ccc|c} -2 & -1 & 17 & 4 \\ 2 & -1 & -1 & -7 \end{array}\right) \rightarrow \left(\begin{array}{ccc|c} 1 & 0 & -9/2 & -11/4 \\ 0 & 1 & -8 & 3/2 \end{array}\right)$. If $z = t$, then the line of intersection is given by $x = -\frac{11}{4} + \frac{9}{2}t$, $y = \frac{3}{2} + 8t$, and $z = t$.

50. Let $Q = (q_1, q_2, q_3)$, $P = (p_1, p_2, p_3)$, $n = (a, b, c)$, and π be given by $ax + by + cz = d$. We want $R = (r_1, r_2, r_3)$ on π and an $\alpha \neq 0$ such that $\vec{RQ} = \alpha \mathbf{n}$. Then we will have $D = |\vec{RQ}|$. $\vec{RQ} = \alpha \mathbf{n}$ gives $r_1 = q_1 - \alpha a$, $r_2 = q_2 - \alpha b$, and $r_3 = q_3 - \alpha c$. Substituting these equations into $ar_1 + br_2 + cr_3 = d$ and solving for α , we obtain $\alpha = \frac{aq_1 + bq_2 + cq_3 - d}{|\mathbf{n}|^2}$. Since $ap_1 + bp_2 + cp_3 = d$, then

$$\alpha = \frac{a(q_1 - p_1) + b(q_2 - p_2) + c(q_3 - p_3)}{|\mathbf{n}|^2} = \frac{\vec{PQ} \cdot \mathbf{n}}{|\mathbf{n}|^2}. \text{ Hence,}$$

$$\begin{aligned} D = |\vec{RQ}| &= |(\alpha a, \alpha b, \alpha c)| = \left| \left(\frac{\vec{PQ} \cdot \mathbf{n}}{|\mathbf{n}|^2} a, \frac{\vec{PQ} \cdot \mathbf{n}}{|\mathbf{n}|^2} b, \frac{\vec{PQ} \cdot \mathbf{n}}{|\mathbf{n}|^2} c \right) \right| \\ &= \left| \frac{\vec{PQ} \cdot \mathbf{n}}{|\mathbf{n}|^2} \mathbf{n} \right| = |\text{proj}_{\mathbf{n}} \vec{PQ}| = \frac{|\vec{PQ} \cdot \mathbf{n}|}{|\mathbf{n}|}. \end{aligned}$$

Use the result of problem 50 to solve 51–53.

51. The point $(0, -3, 0)$ is on the plane. Then $\vec{PQ} = (4 - 0, 0 + 3, 1 - 0) = (4, 3, 1)$, and $D = \frac{|(4, 3, 1) \cdot (2, -1, 8)|}{|(2, -1, 8)|} = \frac{13}{\sqrt{69}}$.

52. The point $(5/2, 0, 0)$ is on the plane. Then $\vec{PQ} = (-7 - 5/2, -2 - 0, -1 - 0) = (-19/2, -2, -1)$, and $D = \frac{|(-19/2, -2, -1) \cdot (-2, 0, 8)|}{|(-2, 0, 8)|} = \frac{11}{2\sqrt{17}}$.

53. The point $(0, 0, 0)$ is on the plane. Then $\vec{PQ} = (-3, 0, 2)$, and $D = \frac{|(-3, 0, 2) \cdot (-3, 1, 5)|}{|(-3, 1, 5)|} = \frac{19}{\sqrt{35}}$.

54. Let $Q = (x_0, y_0, z_0)$. Suppose $P = (x_1, y_1, z_1)$ is on the plane. $\vec{PQ} = (x_0 - x_1, y_0 - y_1, z_0 - z_1)$. By problem 50, we have

$$\begin{aligned} D &= \frac{|\vec{PQ} \cdot \mathbf{n}}{|\mathbf{n}|} = \frac{|a(x_0 - x_1) + b(y_0 - y_1) + c(z_0 - z_1)|}{|\mathbf{n}|} \\ &= \frac{|ax_0 + by_0 + cz_0 - d|}{\sqrt{a^2 + b^2 + c^2}} \end{aligned}$$

55. $\mathbf{n}_1 = (1, -1, 1)$ and $\mathbf{n}_2 = (2, -3, 4)$; $\varphi = \cos^{-1} \frac{(1, -1, 1) \cdot (2, -3, 4)}{|(1, -1, 1)|| (2, -3, 4)|} = \cos^{-1} \frac{9}{\sqrt{3}\sqrt{29}} \approx 0.2657$
56. $\mathbf{n}_1 = (3, -1, 4)$ and $\mathbf{n}_2 = (-4, -2, 7)$; $\varphi = \cos^{-1} \frac{(3, -1, 4) \cdot (-4, -2, 7)}{|(3, -1, 4)|| (-4, -2, 7)|} = \cos^{-1} \frac{18}{\sqrt{26}\sqrt{29}} \approx 1.1319$
57. $\mathbf{n}_1 = (-2, -1, 17)$ and $\mathbf{n}_2 = (2, -1, -1)$; $\varphi = \cos^{-1} \frac{(-2, -1, 17) \cdot (2, -1, -1)}{|(-2, -1, 17)|| (2, -1, -1)|} = \cos^{-1} \frac{20}{\sqrt{294}\sqrt{6}} \approx 1.0745$
58. If \mathbf{u}, \mathbf{v} nonzero, nonparallel vectors, in π , then the line through \mathbf{w} parallel to \mathbf{v} , meets the line through $\mathbf{0}$ and \mathbf{u} at some point $\alpha\mathbf{u}$. Similarly the line through \mathbf{w} parallel to \mathbf{u} meets the line through $\mathbf{0}$ and \mathbf{v} and some point $\beta\mathbf{v}$. Then $\alpha\mathbf{u}, \beta\mathbf{v}$ are sides of a parallelogram with diagonal \mathbf{w} , i.e. $\alpha\mathbf{u} + \beta\mathbf{v} = \mathbf{w}$.
59. Suppose \mathbf{u}, \mathbf{v} , and \mathbf{w} are coplanar. Since $\mathbf{v} \times \mathbf{w}$ is orthogonal to both \mathbf{v} and \mathbf{w} , then $\mathbf{v} \times \mathbf{w}$ is orthogonal to \mathbf{u} . Thus $\mathbf{u} \cdot (\mathbf{v} \times \mathbf{w}) = 0$. Conversely, suppose $\mathbf{u} \cdot (\mathbf{v} \times \mathbf{w}) = 0$. Then $\mathbf{u} \perp \mathbf{v} \times \mathbf{w}$. As $\mathbf{v} \times \mathbf{w}$ is orthogonal to both \mathbf{v} and \mathbf{w} , it follows that \mathbf{u} lies in the plane determined by \mathbf{v} and \mathbf{w} . Use Problem 59 to solve 60–64.
60. $\mathbf{u} \cdot (\mathbf{v} \times \mathbf{w}) = (2, -3, 4) \cdot (1, -22, -17) = 0$; coplanar $\pi : x - 22y - 17z = 0$
61. $\mathbf{u} \cdot (\mathbf{v} \times \mathbf{w}) = (-3, 1, 8) \cdot (-58, 2, -22) = 0$; coplanar $\pi : -58x + 2y - 22z = 0 \Rightarrow -29x + y - 11z = 0$
62. $\mathbf{u} \cdot (\mathbf{v} \times \mathbf{w}) = (2, 1, -2) \cdot (-4, -8, 0) = -16 \neq 0$; not coplanar
63. $\mathbf{u} \cdot (\mathbf{v} \times \mathbf{w}) = (3, -2, 1) \cdot (9, 21, 6) = -9 \neq 0$; not coplanar
64. $\mathbf{u} \cdot (\mathbf{v} \times \mathbf{w}) = (2, -1, -1) \cdot (1, -8, 10) = 0$; coplanar $\pi : x - 8y + 10z = 0$

Review Exercises for Chapter 3

- $|\mathbf{v}| = \sqrt{9+9} = 3\sqrt{2}$; $\tan \varphi = 3/3 = 1 \Rightarrow \varphi = \pi/4$
- $|\mathbf{v}| = \sqrt{9+9} = 3\sqrt{2}$; $\tan \varphi = 3/(-3) = -1 \Rightarrow \varphi = 3\pi/4$
- $|\mathbf{v}| = \sqrt{4+1^2} = 5$; $\tan \varphi = \frac{-2\sqrt{3}}{2} = -\sqrt{3} \Rightarrow \varphi = 10\pi/6$
- $|\mathbf{v}| = \sqrt{3+1} = 2$; $\tan \varphi = \frac{1}{\sqrt{3}} \Rightarrow \varphi = \pi/6$
- $|\mathbf{v}| = \sqrt{144+144} = 12\sqrt{2}$; $\tan \varphi = \frac{-12}{-12} = 1 \Rightarrow \varphi = 5\pi/4$
- $|\mathbf{v}| = \sqrt{1+16} = \sqrt{17}$; $\tan \varphi = 4/1 = 4 \Rightarrow \varphi = \tan^{-1}(4)$ in the first quadrant which is approximately 76° .
- $\vec{PQ} = 2\mathbf{i} + 2\mathbf{j}$ 8. $\vec{PQ} = 6\mathbf{i} + 14\mathbf{j}$ 9. $\vec{PQ} = 4\mathbf{i} + 2\mathbf{j}$ 10. $\vec{PQ} = 4\mathbf{i} - 4\mathbf{j}$
- (a) $5\mathbf{u} = (10, 5)$ (b) $\mathbf{u} - \mathbf{v} = (5, 3)$
(c) $-8\mathbf{u} + 5\mathbf{v} = (-16, -8) + (-15, 20) = (-31, 12)$
- (a) $-3\mathbf{v} = 9\mathbf{i} + 12\mathbf{j}$ (b) $\mathbf{u} + \mathbf{v} = -7\mathbf{i} - 3\mathbf{j}$
(c) $3\mathbf{u} - 6\mathbf{v} = -12\mathbf{i} + 3\mathbf{j} + 18\mathbf{i} + 24\mathbf{j} = 6\mathbf{i} + 27\mathbf{j}$
- $|\mathbf{v}| = \sqrt{2}$; $\mathbf{u} = \frac{1}{\sqrt{2}}(\mathbf{i} + \mathbf{j})$
- $|\mathbf{v}| = \sqrt{29}$; $\mathbf{u} = \frac{1}{\sqrt{29}}(2\mathbf{i} + 5\mathbf{j})$
- $|\mathbf{v}| = 5$; $\mathbf{u} = \frac{1}{5}(3\mathbf{i} + 4\mathbf{j})$
- $|\mathbf{v}| = |a|\sqrt{2}$; $\mathbf{u} = \frac{1}{|a|\sqrt{2}}(a\mathbf{i} + a\mathbf{j})$
- $|\mathbf{v}| = \sqrt{29}$; $\mathbf{u} = \frac{1}{\sqrt{29}}(-5\mathbf{i} - 2\mathbf{j})$
- $|\mathbf{v}| = \sqrt{149}$; $\mathbf{u} = \frac{1}{\sqrt{149}}(-10\mathbf{i} + 7\mathbf{j})$
- $\mathbf{v} = \cos \frac{\pi}{2}\mathbf{i} + \sin \frac{\pi}{2}\mathbf{j} = \mathbf{j}$
- $\mathbf{v} = 7 \cos \frac{5\pi}{6}\mathbf{i} + \sin \frac{5\pi}{6}\mathbf{j} = \frac{-7\sqrt{3}}{2}\mathbf{i} + \frac{7}{2}\mathbf{j}$
- $\mathbf{u} \cdot \mathbf{v} = 0$; $\cos \varphi = 0$
- $\mathbf{u} \cdot \mathbf{v} = 20 - 42 = -22$; $|\mathbf{u}| = \sqrt{65}$; $|\mathbf{v}| = \sqrt{61}$; $\cos \varphi = \frac{-22}{\sqrt{3965}}$
- $\mathbf{u} \cdot \mathbf{v} = -4 - 10 = -14$; $|\mathbf{u}| = \sqrt{5}$; $|\mathbf{v}| = \sqrt{41}$; $\cos \varphi = \frac{-14}{\sqrt{205}}$
- $\mathbf{v} = -1/2\mathbf{u} \Rightarrow \mathbf{u}$ and \mathbf{v} are parallel.
- $\mathbf{u} \cdot \mathbf{v} = 20 + 20 = 40$; $|\mathbf{u}| = |\mathbf{v}| = \sqrt{41}$; $\cos \varphi = \frac{40}{41} \Rightarrow \mathbf{u}$ and \mathbf{v} are not parallel and not orthogonal.
- $\mathbf{u} \cdot \mathbf{v} = -20 - 20 = -40$; $|\mathbf{u}| = |\mathbf{v}| = \sqrt{41}$; $\cos \varphi = \frac{-40}{41} \Rightarrow \mathbf{u}$ and \mathbf{v} are not parallel and not orthogonal.
- $\mathbf{u} = -7\mathbf{v} \Rightarrow \mathbf{u}$ and \mathbf{v} are parallel.
- $|\mathbf{v}| = \sqrt{2}$; $\mathbf{u} = \frac{1}{\sqrt{2}}(-\mathbf{i} + \mathbf{j})$
- $|\mathbf{v}| = \sqrt{58}$; $\mathbf{u} = \frac{1}{\sqrt{58}}(-7\mathbf{i} + 3\mathbf{j})$
- $|\mathbf{v}| = 2\sqrt{2}$; $\mathbf{u} = \frac{1}{\sqrt{2}}(-\mathbf{i} - \mathbf{j})$
- $|\mathbf{v}| = \sqrt{65}$; $\cos \varphi = \frac{4}{\sqrt{65}}$; $\sin \varphi = \frac{-7}{\sqrt{65}}$
- $|\mathbf{v}| = \sqrt{2}$; $\mathbf{u}_1 = \frac{1}{\sqrt{2}}(\mathbf{i} + \mathbf{j})$; $\mathbf{u}_2 = \frac{1}{\sqrt{2}}(-\mathbf{i} - \mathbf{j})$
- $\mathbf{v} = 2 \cos \frac{\pi}{3}\mathbf{i} + 2 \sin \frac{\pi}{3}\mathbf{j} = \mathbf{i} + \sqrt{3}\mathbf{j}$
- $\mathbf{v} = 4 \cos \pi\mathbf{i} + 4 \sin \pi\mathbf{j} = -4\mathbf{i}$
- $\mathbf{u} \cdot \mathbf{v} = 1 - 2 = -1$; $|\mathbf{u}| = \sqrt{2}$; $|\mathbf{v}| = \sqrt{5}$; $\cos \varphi = \frac{-1}{\sqrt{10}}$

36. $\mathbf{u} \cdot \mathbf{v} = 7 - 7 = 0$; \mathbf{u} and \mathbf{v} are orthogonal.

37. $\mathbf{u} = 7\mathbf{v} \Rightarrow \mathbf{u}$ and \mathbf{v} are parallel.

38. (a) $\mathbf{u} \cdot \mathbf{v} = 8 + 3\alpha = 0 \Rightarrow \alpha = -8/3$ (b) $2\mathbf{u} = 4\mathbf{i} + 6\mathbf{j} \Rightarrow \alpha = 6$

(c) $|\mathbf{u}| = \sqrt{13}$; $|\mathbf{v}| = \sqrt{\alpha^2 + 16}$; $\cos \varphi = \frac{3\alpha + 8}{\sqrt{13\alpha^2 + 208}} = \frac{1}{\sqrt{2}} \Rightarrow 18\alpha^2 + 96\alpha + 128 = 13\alpha^2 + 208 \Rightarrow$

$5\alpha^2 + 96\alpha - 80 = 0 \Rightarrow (5\alpha - 4)(\alpha + 20) = 0 \Rightarrow \alpha = 4/5, -20$ $\alpha = -4/5 \Rightarrow \varphi = \pi/4$

(d) $\frac{3\alpha + 8}{\sqrt{13\alpha^2 + 208}} = \frac{\sqrt{3}}{2} \Rightarrow 36\alpha^2 + 192\alpha + 256 = 39\alpha^2 + 624 \Rightarrow 3\alpha^2 - 192\alpha + 368 = 0 \Rightarrow \alpha = \frac{96 \pm 52\sqrt{3}}{3}$

39. $\text{proj}_{\mathbf{v}} \mathbf{u} = \frac{14}{2}(\mathbf{i} + \mathbf{j}) = 7\mathbf{i} + 7\mathbf{j}$

40. $\text{proj}_{\mathbf{v}} \mathbf{u} = \frac{14}{2}(\mathbf{i} - \mathbf{j}) = 7\mathbf{i} - 7\mathbf{j}$

41. $\text{proj}_{\mathbf{v}} \mathbf{u} = \frac{5}{13}(3\mathbf{i} + 2\mathbf{j}) = \frac{15}{13}\mathbf{i} + \frac{10}{13}\mathbf{j}$

42. $\text{proj}_{\mathbf{v}} \mathbf{u} = \frac{-3}{10}(\mathbf{i} - 3\mathbf{j}) = \frac{-3}{10}\mathbf{i} + \frac{9}{10}\mathbf{j}$

43. $\text{proj}_{\mathbf{v}} \mathbf{u} = \frac{29}{58}(-3\mathbf{i} - 7\mathbf{j}) = \frac{-3}{2}\mathbf{i} - \frac{7}{2}\mathbf{j}$

44. $\text{proj}_{\mathbf{v}} \mathbf{u} = \frac{-7}{10}(-3\mathbf{i} - \mathbf{j}) = \frac{21}{10}\mathbf{i} + \frac{7}{10}\mathbf{j}$

45. $\vec{PQ} = \mathbf{i} + 9\mathbf{j}$; $\vec{RS} = 3\mathbf{i} - 4\mathbf{j}$; $\text{proj}_{\vec{PQ}} \vec{RS} = \frac{-33}{82}(\mathbf{i} + 9\mathbf{j}) = \frac{-33}{82}\mathbf{i} - \frac{297}{82}\mathbf{j}$;

$\text{proj}_{\vec{RS}} \vec{PQ} = \frac{-33}{5}(3\mathbf{i} - 4\mathbf{j}) = \frac{-99}{5}\mathbf{i} + \frac{132}{5}\mathbf{j}$

46. $\sqrt{(4+5)^2 + (-1-1)^2 + (7-3)^2} = \sqrt{101}$

47. $\sqrt{(-2-0)^2 + (4-0)^2 + (-8-6)^2} = \sqrt{216} = 6\sqrt{6}$

48. $\sqrt{(2-0)^2 + (-7-5)^2 + (0+8)^2} = \sqrt{212} = 2\sqrt{53}$

49. $|\mathbf{v}| = \sqrt{130}$; $\cos \alpha = 0$; $\cos \beta = \frac{3}{\sqrt{130}}$; $\cos \gamma = \frac{11}{\sqrt{130}}$

50. $|\mathbf{v}| = \sqrt{14}$; $\cos \alpha = \frac{1}{\sqrt{14}}$; $\cos \beta = \frac{-2}{\sqrt{14}}$; $\cos \gamma = \frac{-3}{\sqrt{14}}$

51. $|\mathbf{v}| = \sqrt{53}$; $\cos \alpha = \frac{-4}{\sqrt{53}}$; $\cos \beta = \frac{1}{\sqrt{53}}$; $\cos \gamma = \frac{6}{\sqrt{53}}$

52. $\vec{PQ} = -7\mathbf{i} + 2\mathbf{j} + 5\mathbf{k}$; $|\vec{PQ}| = \sqrt{78}$

$\mathbf{u} = \frac{-7}{\sqrt{78}}\mathbf{i} - \frac{2}{\sqrt{78}}\mathbf{j} + \frac{5}{\sqrt{78}}\mathbf{k}$

53. $\vec{PQ} = -8\mathbf{i} + 4\mathbf{j} - 4\mathbf{k}$; $|\vec{PQ}| = \sqrt{96} = 4\sqrt{6}$

$\mathbf{u} = \frac{2}{\sqrt{6}}\mathbf{i} - \frac{1}{\sqrt{6}}\mathbf{j} + \frac{1}{\sqrt{6}}\mathbf{k}$

54. $\mathbf{u} - \mathbf{v} = 4\mathbf{i} - 4\mathbf{j} - 2\mathbf{k}$

55. $3\mathbf{v} + 5\mathbf{w} = (-9\mathbf{i} + 6\mathbf{j} + 15\mathbf{k}) + (10\mathbf{i} - 20\mathbf{j} + 5\mathbf{k}) = \mathbf{i} - 14\mathbf{j} + 20\mathbf{k}$

56. $\text{proj}_{\mathbf{v}} \mathbf{w} = \frac{-9}{38}(-3\mathbf{i} + 2\mathbf{j} + 5\mathbf{k}) = \frac{27}{38}\mathbf{i} - \frac{9}{38}\mathbf{j} - \frac{45}{38}\mathbf{k}$

57. $\text{proj}_{\mathbf{w}} \mathbf{u} = \frac{13}{21}(2\mathbf{i} - 4\mathbf{j} + \mathbf{k}) = \frac{26}{21}\mathbf{i} - \frac{52}{21}\mathbf{j} + \frac{13}{21}\mathbf{k}$

58. $2\mathbf{u} - 4\mathbf{v} + 7\mathbf{w} = (2\mathbf{i} - 4\mathbf{j} + 6\mathbf{k}) - (-12\mathbf{i} + 8\mathbf{j} + 20\mathbf{k}) + (14\mathbf{i} - 28\mathbf{j} + 7\mathbf{k}) = 28\mathbf{i} - 20\mathbf{j} - 7\mathbf{k}$

59. $\mathbf{u} \cdot \mathbf{v} - \mathbf{w} \cdot \mathbf{v} = 13 - (-9) = 22$

$$60. \cos \varphi = \frac{8}{\sqrt{14}\sqrt{38}} = \frac{8}{\sqrt{532}} = \frac{4}{\sqrt{133}}; \varphi = \arccos\left(\frac{4}{\sqrt{133}}\right), \text{ which is approximately } 69.7^\circ.$$

$$61. \cos \varphi = \frac{-9}{\sqrt{38}\sqrt{21}} = \frac{-9}{\sqrt{798}}; \varphi = \arccos\left(\frac{-9}{\sqrt{798}}\right), \text{ which is approximately } 108.6^\circ.$$

$$62. \mathbf{u} \times \mathbf{v} = \begin{vmatrix} \mathbf{i} & \mathbf{j} & \mathbf{k} \\ 3 & -1 & 0 \\ 2 & 0 & 4 \end{vmatrix} = -4\mathbf{i} - 12\mathbf{j} + 2\mathbf{k}$$

$$63. \mathbf{u} \times \mathbf{v} = \begin{vmatrix} \mathbf{i} & \mathbf{j} & \mathbf{k} \\ 0 & 7 & 0 \\ 1 & 0 & -1 \end{vmatrix} = -7\mathbf{i} - 7\mathbf{k}$$

$$64. \mathbf{u} \times \mathbf{v} = \begin{vmatrix} \mathbf{i} & \mathbf{j} & \mathbf{k} \\ 4 & -1 & 7 \\ -7 & 1 & -2 \end{vmatrix} = -5\mathbf{i} - 41\mathbf{j} - 3\mathbf{k}$$

$$65. \mathbf{u} \times \mathbf{v} = \begin{vmatrix} \mathbf{i} & \mathbf{j} & \mathbf{k} \\ -2 & 3 & -4 \\ -3 & 1 & -10 \end{vmatrix} = -26\mathbf{i} - 8\mathbf{j} + 7\mathbf{k}$$

$$66. \mathbf{u} \times \mathbf{v} = \begin{vmatrix} \mathbf{i} & \mathbf{j} & \mathbf{k} \\ 1 & -1 & 3 \\ -2 & -3 & 4 \end{vmatrix} = 5\mathbf{i} - 10\mathbf{j} - \mathbf{k}$$

$$|\mathbf{u} \times \mathbf{v}| = \sqrt{126} = 3\sqrt{14}$$

$$\mathbf{u}_1 = \frac{5}{3\sqrt{14}}\mathbf{i} - \frac{10}{3\sqrt{14}}\mathbf{j} - \frac{1}{3\sqrt{14}}\mathbf{k}; \mathbf{u}_2 = -\mathbf{u}_1$$

$$67. \mathbf{u} = 4\mathbf{i} + 3\mathbf{j} - 8\mathbf{k}; \mathbf{v} = 4\mathbf{i} - 3\mathbf{j} - 3\mathbf{k};$$

$$\mathbf{u} \times \mathbf{v} = \begin{vmatrix} \mathbf{i} & \mathbf{j} & \mathbf{k} \\ 4 & 3 & -8 \\ 4 & -3 & -3 \end{vmatrix} = 15\mathbf{i} - 20\mathbf{j} - 24\mathbf{k}; \text{ Area} = |\mathbf{u} \times \mathbf{v}| = \sqrt{1201}$$

$$68. \mathbf{v} = 4\mathbf{i} - 7\mathbf{j} + 2\mathbf{k}$$

$$\text{vector equation: } x\mathbf{i} + y\mathbf{j} + z\mathbf{k} = 3\mathbf{i} - \mathbf{j} + 4\mathbf{k} + t(4\mathbf{i} - 7\mathbf{j} + 2\mathbf{k})$$

$$\text{parametric equation: } x = 3 + 4t, y = -1 - 7t, z = 4 + 2t$$

$$\text{symmetric equation: } \frac{x+3}{4} = \frac{y+1}{-7} = \frac{z-4}{2}$$

$$69. \mathbf{v} = 7\mathbf{i} - \mathbf{j} + 7\mathbf{k}$$

$$\text{vector equation: } x\mathbf{i} + y\mathbf{j} + z\mathbf{k} = -4\mathbf{i} + \mathbf{j} + t(7\mathbf{i} - \mathbf{j} + 7\mathbf{k})$$

$$\text{parametric equation: } x = -4 + 7t, y = 1 - t, z = 7t$$

$$\text{symmetric equation: } \frac{x+4}{7} = \frac{y-1}{-1} = \frac{z}{7}$$

$$70. \mathbf{v} = 3\mathbf{i} - \mathbf{j} - \mathbf{k}$$

$$\text{vector equation: } x\mathbf{i} + y\mathbf{j} + z\mathbf{k} = 3\mathbf{i} + \mathbf{j} + 2\mathbf{k} + t(3\mathbf{i} - \mathbf{j} - \mathbf{k})$$

$$\text{parametric equation: } x = 3 + 3t, y = 2 - t, z = 2 - t$$

$$\text{symmetric equation: } \frac{x+3}{3} = \frac{y+1}{-1} = \frac{z-4}{-1}$$

$$71. \mathbf{v} = 5\mathbf{i} - 3\mathbf{j} + 2\mathbf{k}$$

$$\text{vector equation: } x\mathbf{i} + y\mathbf{j} + z\mathbf{k} = \mathbf{i} - 2\mathbf{j} - 3\mathbf{k} + t(5\mathbf{i} - 3\mathbf{j} + 2\mathbf{k})$$

$$\text{parametric equation: } x = 1 + 5t, y = -2 - 3t, z = -3 + 2t$$

$$\text{symmetric equation: } \frac{x-1}{5} = \frac{y+2}{-3} = \frac{z+3}{2}$$

$$72. \text{ We would need } 3 - 2t = -3 + s \Rightarrow t = \frac{6-s}{2}; 4 + t = 2 - 4s \Rightarrow t = -2 - 4s, \text{ and } -2 + 7t = 1 + 6s \Rightarrow$$

$$t = \frac{3+6s}{7}; \frac{6-s}{2} = -2 - 4s \Rightarrow s = -10/7, \text{ and } -2 - 4s = \frac{3+6s}{7} \Rightarrow s = -17/22; \text{ Thus there is no}$$

point of intersection.

73. The parametric equation of the line: $x = 3 + 2t$, $y = 1 - t$, $z = 5 + t$. Then $2(3 + 2t) - (1 - t) + (5 + t) = 0 \Rightarrow 6t + 10 - 0 \Rightarrow t = 5/3$, $x = 19/3$, $y = -2/3$, $z = 20/3$; $d = \sqrt{\frac{361}{9} + \frac{4}{9} + \frac{400}{9}} = \sqrt{85}$

74. $\mathbf{v}_1 = 4\mathbf{i} + 3\mathbf{j} - 2\mathbf{k}$; $\mathbf{v}_2 = 5\mathbf{i} + \mathbf{j} + 4\mathbf{k}$.

$$\mathbf{v} = \mathbf{v}_1 \times \mathbf{v}_2 = \begin{vmatrix} \mathbf{i} & \mathbf{j} & \mathbf{k} \\ 4 & 3 & -2 \\ 5 & 1 & 4 \end{vmatrix} = 14\mathbf{i} - 26\mathbf{j} - 11\mathbf{k}$$

The line is: $x = -1 + 14t$, $y = 2 - 26t$, $z = 4 - 11t$.

75. $1(x - 1) + 0(y - 3) + 1(z + 2) = 0 \Rightarrow x + z = -1$

76. $0(x - 1) + 2(y + 4) - 3(z - 6) = 0 \Rightarrow 2y - 3z = -26$

77. $2(x + 4) - 3(y - 1) + 5(z - 6) = 0 \Rightarrow 2x - 3y + 5z = 19$

78. $P = (-2, 4, 1)$, $Q = (3, -7, 5)$, $R = (-1, -2, -1)$;

$$\vec{PQ} = 5\mathbf{i} - 11\mathbf{j} + 4\mathbf{k}; \vec{QR} = -4\mathbf{i} + 5\mathbf{j} - 6\mathbf{k};$$

$$\mathbf{n} = \vec{PQ} \times \vec{QR} = \begin{vmatrix} \mathbf{i} & \mathbf{j} & \mathbf{k} \\ 5 & -11 & 4 \\ -4 & 5 & -6 \end{vmatrix} = 46\mathbf{i} + 14\mathbf{j} + 69\mathbf{k}$$

$$46(x + 2) + 14(y - 4) + 69(z - 1) = 0 \Rightarrow 46x + 14y + 69z = 33$$

79. $\left(\begin{array}{ccc|c} -1 & 1 & 1 & 3 \\ -4 & 2 & -7 & 5 \end{array} \right) \Rightarrow \left(\begin{array}{ccc|c} 1 & -1 & -1 & -3 \\ 0 & -2 & -11 & -7 \end{array} \right) \Rightarrow \left(\begin{array}{ccc|c} 1 & 0 & 9/2 & 1/2 \\ 0 & 1 & 11/2 & 7/2 \end{array} \right)$

$$x = \frac{1}{2} - \frac{9}{2}t, y = \frac{7}{2} - \frac{11}{2}t, z = t$$

80. $\mathbf{n}_1 \times \mathbf{n}_2 = \begin{vmatrix} \mathbf{i} & \mathbf{j} & \mathbf{k} \\ -4 & 6 & 8 \\ 2 & -3 & -4 \end{vmatrix} = 0\mathbf{i} + 0\mathbf{j} + 0\mathbf{k} \Rightarrow$ no points of intersection

81. $\left(\begin{array}{ccc|c} 3 & -1 & 4 & 8 \\ -3 & -1 & -11 & 0 \end{array} \right) \Rightarrow \left(\begin{array}{ccc|c} 1 & -1/3 & 4/3 & 8/3 \\ 0 & -2 & -7 & 8 \end{array} \right) \Rightarrow \left(\begin{array}{ccc|c} 1 & 0 & 15/6 & 4/3 \\ 0 & 1 & 7/2 & -4 \end{array} \right)$

$$x = \frac{4}{3} - \frac{15}{6}t, y = -4 - \frac{7}{2}t, z = t$$

82. $(3, 0, 0)$ is a point in the plane.

Let $\mathbf{p} = (1 - 3)\mathbf{i} + (-2 - 0)\mathbf{j} + (3 - 0)\mathbf{k} = -2\mathbf{i} - 2\mathbf{j} + 3\mathbf{k}$, $\mathbf{n} = 2\mathbf{i} - \mathbf{j} - \mathbf{k}$

$$\text{proj}_{\mathbf{n}} \mathbf{p} = \frac{-5}{6}(2\mathbf{i} - \mathbf{j} - \mathbf{k}) = \frac{-10}{6}\mathbf{i} + \frac{5}{6}\mathbf{j} + \frac{5}{6}\mathbf{k}$$

$$d = |\text{proj}_{\mathbf{n}} \mathbf{p}| = \sqrt{\frac{150}{6}} = \frac{5}{\sqrt{6}}$$

83. $\mathbf{n}_1 = -\mathbf{i} + \mathbf{j} + \mathbf{k}$; $\mathbf{n}_2 = -4\mathbf{i} + 2\mathbf{j} - 7\mathbf{k}$

$$\cos \varphi = \frac{-1}{\sqrt{3}\sqrt{69}} = \frac{-1}{3\sqrt{23}}; \varphi = \cos^{-1}\left(\frac{-1}{3\sqrt{23}}\right), \text{ which is approximately } 94^\circ.$$

84. $\mathbf{n} = \mathbf{u} \times \mathbf{v} = \begin{vmatrix} \mathbf{i} & \mathbf{j} & \mathbf{k} \\ 1 & -2 & 1 \\ 3 & 2 & -3 \end{vmatrix} = 4\mathbf{i} + 6\mathbf{j} + 8\mathbf{k}$

Plane: $4(x - 1) + 6(y + 2) + 8(z - 1) = 0 \Rightarrow 4x + 6y + 8z = 0$

Then $4(9) + 6(-2) + 8(-3) = 36 - 12 - 24 = 0$. Thus \mathbf{u} , \mathbf{v} , and \mathbf{w} are coplanar.

Chapter 4. Vector Spaces

Section 4.2

- yes; (i) the sum of two diagonal matrices is diagonal; the rest of the axioms follow from theorem 1.5.1.
- no; (iv) not every diagonal matrix has a multiplicative inverse.
- no; (iv) if $(x, y) \in V$, $y < 0$ then $(-x, -y) \notin V$ since $-y > 0$; (vi) does not hold if $\alpha < 0$ and $y < 0$.
- no; (iv) if (x, y) is strictly in the first quadrant, then $(-x, -y)$ is in the third quadrant; (vi) does not hold if $\alpha < 0$.
- yes; (i) $(x, x, x) + (y, y, y) = (x + y, x + y, x + y) \in V$; (iii) $(0, 0, 0) \in V$; (iv) if $(x, x, x) \in V$, then $(-x, -x, -x) \in V$; (vi) $\alpha(x, x, x) = (\alpha x, \alpha x, \alpha x) \in V$; the rest of the axioms follow from theorem 1.5.1.
- no; (i) $x^4 - x^4 = 0$; (iii) $0 \notin V$
- yes; the axioms follow from theorems 1.9.1 and 1.5.1.
- yes; (i) $\begin{pmatrix} 0 & a \\ b & 0 \end{pmatrix} + \begin{pmatrix} 0 & \alpha \\ \beta & 0 \end{pmatrix} = \begin{pmatrix} 0 & a + \alpha \\ b + \beta & 0 \end{pmatrix}$; (iii) $\begin{pmatrix} 0 & 0 \\ 0 & 0 \end{pmatrix} \in V$; $\alpha \begin{pmatrix} 0 & a \\ b & 0 \end{pmatrix} = \begin{pmatrix} 0 & \alpha a \\ \alpha b & 0 \end{pmatrix} \in V$; the rest of the axioms follow from theorem 1.5.1.
- no; (i) $\begin{pmatrix} 1 & \alpha \\ \beta & 1 \end{pmatrix} + \begin{pmatrix} 1 & a \\ b & 1 \end{pmatrix} = \begin{pmatrix} 2 & \alpha + a \\ \beta + b & 2 \end{pmatrix} \notin V$; (iii) $\begin{pmatrix} 0 & 0 \\ 0 & 0 \end{pmatrix} \notin V$; (iv) $-\begin{pmatrix} 1 & \alpha \\ \beta & 1 \end{pmatrix} = \begin{pmatrix} -1 & -\alpha \\ -\beta & -1 \end{pmatrix} \notin V$;
(vi) $\alpha \begin{pmatrix} 1 & a \\ b & 1 \end{pmatrix} = \begin{pmatrix} \alpha & \alpha a \\ \alpha b & \alpha \end{pmatrix} \notin V$ if $\alpha \neq 1$;
- yes; it is a trivial vector space.
- yes; (i) the sum of two polynomials with a zero constant term will have a zero constant term; (iii) $0 \in V$; (iv) if $p(x) \in V$, then $-p(x) \in V$; (vi) $\alpha p(x)$ has a zero constant term for every scalar α ; the rest of the axioms follow from the usual rules of addition and scalar multiplication of polynomials.
- no; (iii) $0 \notin V$; (iv) if $p(x) \in V$, then $-p(x) \notin V$ since it does not have a positive constant term; (vi) does not hold if $\alpha < 0$.
- yes; (i) if $f \in V$ and $g \in V$, then $f + g$ is continuous and $f(0) + g(0) = f(1) + g(1) = 0$; (iii) $0 \in V$;
(iv) if $f \in V$, then $-f$ is continuous and $(-f)(0) = (-f)(1) = 0$; the rest of the axioms follow from the usual rules of adding functions and multiplying them by real numbers.
- yes; (i) $t_1(a, b, c) + t_2(a, b, c) = (t_1 + t_2)(a, b, c) \in V$; (iii) $(0, 0, 0) \in V$; (iv) if $(\alpha, \beta, \gamma) = t(a, b, c) \in V$, then $(-\alpha, -\beta, -\gamma) = (-t)(a, b, c) \in V$; (vi) $\alpha[t(a, b, c)] = (\alpha t)(a, b, c) \in V$ for every $\alpha \in \mathbb{R}$; the rest of the axioms follow from section 1.5.
- no; (i) for example, $(1, 0, -1) + (2, 2, 0) = (3, 2, -1)$ is not on the line; (iii) $(0, 0, 0) \notin V$; (iv) $(-1, 0, 1)$ is not on the line; (vi) $(2, 0, -2)$ is not on the line.
- no; (vii) if $\alpha \neq 1$, then

$$\begin{aligned} \alpha(\mathbf{x} + \mathbf{y}) &= \alpha((x_1, x_2) + (y_1, y_2)) \\ &= (\alpha x_1 + \alpha y_1 + \alpha, \alpha x_2 + \alpha y_2 + \alpha) \\ &\neq \alpha \mathbf{x} + \alpha \mathbf{y} = (\alpha x_1 + \alpha y_1, \alpha x_2 + \alpha y_2 + 1); \end{aligned}$$

$$\begin{aligned} \text{(viii)} \quad (\alpha + \beta)\mathbf{x} &= ((\alpha + \beta)x_1, (\alpha + \beta)x_2) \\ &\neq \alpha \mathbf{x} + \beta \mathbf{x} = ((\alpha + \beta)x_1 + 1, (\alpha + \beta)x_2 + 1) \end{aligned}$$

17. yes; (iii) the zero vector is $(-1, -1)$; (iv) if $\mathbf{x} = (x, y) \in V$, then the additive inverse of \mathbf{x} is $(-x - 2, -y - 2)$; the rest of the axioms follow, after some careful algebra.
18. yes; it is a trivial vector space.
19. yes; (i) the sum of two differentiable functions defined on $[0, 1]$ is differentiable on $[0, 1]$; (vi) if f is differentiable on $[0, 1]$, then αf is differentiable on $[0, 1]$ for every scalar α ; the rest of the axioms follow from the usual rules of adding functions and multiplying them by real numbers.
20. yes, providing we understand that scalar now means *rational* number; (i) $(a + b\sqrt{2}) + (c + d\sqrt{2}) = (a + c) + (b + d)\sqrt{2} \in V$ since the sum of two rational numbers is rational; (vi) $\alpha(a + b\sqrt{2}) = \alpha a + \alpha b\sqrt{2} \in V$ since the product of two rational numbers is rational; the rest of the axioms follow as special cases of the rules for addition and multiplication for rational numbers.
21. Suppose $\mathbf{0}$ and $\mathbf{0}'$ are both additive identities. Then $\mathbf{0} = \mathbf{0} + \mathbf{0}'$ and $\mathbf{0}' = \mathbf{0} + \mathbf{0}'$. Thus, $\mathbf{0} = \mathbf{0}'$.
22. Suppose $\mathbf{x} + \mathbf{y} = \mathbf{0}$ and $\mathbf{x} + \mathbf{z} = \mathbf{0}$. So $\mathbf{x} + \mathbf{y} = \mathbf{x} + \mathbf{z}$. Adding \mathbf{y} to both sides of the equation gives $\mathbf{y} + (\mathbf{x} + \mathbf{y}) = \mathbf{y} + (\mathbf{x} + \mathbf{z})$. Using properties (ii) and (v), we obtain $\mathbf{y} + \mathbf{0} = \mathbf{0} + \mathbf{z}$. Thus, $\mathbf{y} = \mathbf{z}$.
23. Define $\mathbf{z} = (-\mathbf{x}) + \mathbf{y}$. By properties (i) and (iv), \mathbf{z} exists. Adding \mathbf{x} to both sides, we obtain $\mathbf{x} + \mathbf{z} = \mathbf{x} + ((-\mathbf{x}) + \mathbf{y}) = (\mathbf{x} - \mathbf{x}) + \mathbf{y} = \mathbf{0} + \mathbf{y} = \mathbf{y}$. Suppose \mathbf{z} and \mathbf{z}' are such that $\mathbf{x} + \mathbf{z} = \mathbf{y}$ and $\mathbf{x} + \mathbf{z}' = \mathbf{y}$. Then adding $(-\mathbf{x})$ to both yields $\mathbf{z} = (-\mathbf{x}) + \mathbf{y} = \mathbf{z}'$.
24. (i) if $x > 0$ and $y > 0$, then $x + y = xy > 0$; (ii) $(x + y) + z = xy + z = xyz = x + yz = x + (y + z)$; (iii) $x + 1 = x \cdot 1 = x = 1 + x = 1 \cdot x$; (iv) $x + x^{-1} = x \cdot x^{-1} = 1$; (v) $x + y = xy = yx = y + x$; (vi) if $x > 0$, then $\alpha x = x^\alpha > 0$ for any α ; (vii) $\alpha(x + y) = \alpha xy = (xy)^\alpha = x^\alpha y^\alpha = x^\alpha + y^\alpha = \alpha x + \alpha y$; (viii) $(\alpha + \beta)x = x^{(\alpha + \beta)} = x^\alpha x^\beta = x^\alpha + x^\beta = \alpha x + \beta x$; (ix) $\alpha(\beta x) = (\beta x)^\alpha = (x^\alpha)^\beta = x^{\alpha\beta} = (\alpha\beta)x$; (x) $1x = x^1 = x$
25. (i) Suppose y_1 and y_2 are solutions. Then

$$\begin{aligned} & (y_1 + y_2)'' + a(x)(y_1 + y_2)' + b(x)(y_1 + y_2) \\ &= y_1'' + a(x)y_1' + b(x)y_1 + y_2'' + a(x)y_2' + b(x)y_2 = 0 + 0 = 0. \end{aligned}$$

Thus $y_1 + y_2$ is a solution. Similarly,

$$(\alpha y_1)'' + a(x)(\alpha y_1)' + b(x)(\alpha y_1) = \alpha(y_1'' + a(x)y_1' + b(x)y_1) = 0.$$

Hence, we have closure under addition and scalar multiplication. The additive inverse of y_1 is $(-1)y_1 = -y_1$. The rest of the axioms follow from the usual rules for addition and scalar multiplication of functions.

MATLAB 4.2

1. This problem is a demo from vetrsp.m.
2. (a) The zero vector will be the matrix with all zero elements.

```

>> n = 3; m = 4;           % Choose values for m and n.
>> X = round(10*(2*rand(n,m)-1)) % Some random matrices.
X =
    7    -5    -1    -7
   -2    -2    -4     1
    7     1    -6     6

>> Y = round(10*(2*rand(n,m)-1))
Y =
   -9     9     8    -7
    1     5     2    -6
    0     1     7     4

>> Z = round(10*(2*rand(n,m)-1))
Z =
   -7   -10     4    -6
   -8    -2     9    -4
   -5    -9    -5     8

>> a = 2*rand(1)-1        % A random scalar.
a =
    0.3041

>> b = 2*rand(1)-2
b =
   -1.6993

>> X+Y                    % (i) This should be an nxm matrix.
ans =
   -2     4     7   -14
   -1     3    -2    -5
    7     2     1    10

>> (X+Y)+Z, X+(Y+Z)      % (ii) These should be the same.
ans =
   -9    -6    11   -20
   -9     1     7    -9
    2    -7    -4    18
ans =
   -9    -6    11   -20
   -9     1     7    -9
    2    -7    -4    18

>> X+zeros(3,4), zeros(3,4)+X % (iii) These should both be X.
ans =                                % Note zeros(n, m) is the additive identity.
    7    -5    -1    -7
   -2    -2    -4     1
    7     1    -6     6
ans =
    7    -5    -1    -7
   -2    -2    -4     1
    7     1    -6     6

```

```

>> M = -X                                % (iv) This should be an nxm matrix.
M =
    -7     5     1     7
     2     2     4    -1
    -7    -1     6    -6

>> X + M                                    % This should be zero.
ans =
     0     0     0     0
     0     0     0     0
     0     0     0     0

>> X+Y, Y+X                                % (v) These should be the same.
ans =
    -2     4     7   -14
    -1     3     -2    -5
     7     2     1    10
ans =
    -2     4     7   -14
    -1     3     -2    -5
     7     2     1    10

>> a*X                                      % (vi) This should be an nxm matrix.
ans =
    2.1288   -1.5206   -0.3041   -2.1288
   -0.6082   -0.6082   -1.2165    0.3041
    2.1288    0.3041   -1.8247    1.8247

>> a*(X+Y), a*X + a*Y                    % (vii) These should be the same.
ans =
   -0.6082    1.2165    2.1288   -4.2576
   -0.3041    0.9124   -0.6082   -1.5206
    2.1288    0.6082    0.3041    3.0412
ans =
   -0.6082    1.2165    2.1288   -4.2576
   -0.3041    0.9124   -0.6082   -1.5206
    2.1288    0.6082    0.3041    3.0412

>> (a+b)*X, a*X + b*X                    % (viii) These should be the same.
ans =
   -9.7665    6.9761    1.3952    9.7665
    2.7904    2.7904    5.5809   -1.3952
   -9.7665   -1.3952    8.3713   -8.3713
ans =
   -9.7665    6.9761    1.3952    9.7665
    2.7904    2.7904    5.5809   -1.3952
   -9.7665   -1.3952    8.3713   -8.3713

>> a*(b*X), (a*b)*X                      % (ix) These should be the same.
ans =
   -3.6176    2.5840    0.5168    3.6176
    1.0336    1.0336    2.0672   -0.5168
   -3.6176   -0.5168    3.1008   -3.1008
ans =
   -3.6176    2.5840    0.5168    3.6176
    1.0336    1.0336    2.0672   -0.5168
   -3.6176   -0.5168    3.1008   -3.1008

```

```

>> 1*X                               % (x) This should be X.
ans =
     7     -5     -1     -7
    -2     -2     -4     1
     7     1     -6     6

```

- (b) To prove that M_{nm} is a vector space, we must check all ten of the vector space axioms. Let $X = (x_{ij})$, $Y = (y_{ij})$, and $Z = (z_{ij})$ be any $m \times n$ matrices and let α and β be any scalars. From the definition of matrix addition in Section 1.5, we know (i) $X + Y$ is in M_{nm} , and that (ii) $(X + Y) + Z = X + (Y + Z)$. (iii) The zero vector will be the $m \times n$ matrix with zero entries, so that $X + 0 = 0 + X = X$. (iv) The negative of X is the matrix whose entries are the negatives of those in X . (v) The entries of $X + Y$ are $x_{ij} + y_{ij} = y_{ij} + x_{ij}$ which are those of $Y + X$. (vi) The scalar multiplication αX , was defined as the $m \times n$ matrix whose entries are αx_{ij} . (vii) The entries of $\alpha(X + Y)$ are $\alpha(x_{ij} + y_{ij}) = \alpha x_{ij} + \alpha y_{ij}$, which are the entries of $\alpha X + \alpha Y$. (viii) The entries of $(\alpha + \beta)X$ are $(\alpha + \beta)x_{ij} = \alpha x_{ij} + \beta x_{ij}$, which are the entries of $\alpha X + \beta X$. (ix) The entries of $\alpha(\beta X)$ are $\alpha(\beta x_{ij}) = (\alpha\beta)x_{ij}$ which are the entries of $(\alpha\beta)X$. (x) The entries of $1X$ are $1x_{ij} = x_{ij}$, which are those of X . (Section 1.5, Problems 41–43 prove some of these.)
- (c) Part (a) gives evidence that M_{nm} is probably a vector space, but it does not prove that it is a vector space, since most assertions involve all X, Y, Z, α, β and (a) only gave some examples.

Section 4.3

For each problem in which H is a subspace you should explain why Theorem 1 holds.

1. H is not a subspace. For $\alpha < 0$, $\alpha(x, y) = (\alpha x, \alpha y) \notin H$, since $\alpha y < 0$ for $y > 0$.
2. H is a subspace
3. H is a subspace.
4. H is not a subspace. $(1, 0) \notin H$, but $2(1, 0) = (2, 0) \notin H$.
5. H is a subspace.
6. H is a subspace.
7. H is a subspace.
8. H is a subspace.
9. H is a subspace.
10. H is not a subspace. $\begin{pmatrix} a & 1+a \\ 0 & 0 \end{pmatrix} + \begin{pmatrix} b & 1+b \\ 0 & 0 \end{pmatrix} = \begin{pmatrix} a+b & 2+a+b \\ 0 & 0 \end{pmatrix} \notin H$.
11. H is a subspace.
12. H is not a subspace. H does not contain 0 .
13. H is a subspace.
14. H is a subspace.
15. H is not a subspace. H does not contain 0 .
16. H is a subspace.
17. H is not a subspace. H does not contain 0 .
18. H is a subspace.
19. H is a subspace.
20. H is not a subspace. H does not contain 0 .
21. (a) $\begin{pmatrix} 0 & a \\ b & c \end{pmatrix} + \begin{pmatrix} 0 & d \\ e & f \end{pmatrix} = \begin{pmatrix} 0 & a+d \\ b+c & c+f \end{pmatrix} \in H_1$; $\alpha \begin{pmatrix} 0 & a \\ b & c \end{pmatrix} = \begin{pmatrix} 0 & \alpha a \\ \alpha b & \alpha c \end{pmatrix} \in H_1$. So H_1 is a subspace of V .
 $\begin{pmatrix} -b & a \\ a & b \end{pmatrix} + \begin{pmatrix} -d & c \\ c & d \end{pmatrix} = \begin{pmatrix} -(b+d) & a+c \\ a+c & b+d \end{pmatrix} \in H_2$; $\alpha \begin{pmatrix} -b & a \\ a & b \end{pmatrix} = \begin{pmatrix} -\alpha b & \alpha a \\ \alpha a & \alpha b \end{pmatrix} \in H_2$. So H_2 is a subspace of V .
 (b) $H_1 \cap H_2 = \left\{ A \in M_{22} : A = \begin{pmatrix} 0 & a \\ a & 0 \end{pmatrix} \right\}$. $\begin{pmatrix} 0 & a \\ a & 0 \end{pmatrix} + \begin{pmatrix} 0 & b \\ b & 0 \end{pmatrix} = \begin{pmatrix} 0 & a+b \\ a+b & 0 \end{pmatrix} \in H_1 \cap H_2$; $\alpha \begin{pmatrix} 0 & a \\ a & 0 \end{pmatrix} = \begin{pmatrix} 0 & \alpha a \\ \alpha a & 0 \end{pmatrix} \in H_1 \cap H_2$. So $H_1 \cap H_2$ is a subspace of V .
22. Since every polynomial has a continuous first derivative, $H_1 \cap H_2 = H_1$. As shown in example 10, H_1 is a subspace.
23. Suppose $\mathbf{x} \in H$ and $\mathbf{y} \in H$. Then $A(\mathbf{x} + \mathbf{y}) = A\mathbf{x} + A\mathbf{y} = \mathbf{0} + \mathbf{0} = \mathbf{0}$. Thus, $\mathbf{x} + \mathbf{y} \in H$. $A(\alpha\mathbf{x}) = \alpha \cdot A\mathbf{x} = \alpha \cdot \mathbf{0} = \mathbf{0}$. Thus $\alpha\mathbf{x} \in H$ for every scalar α . Then H is a subspace of \mathbb{R}^n .
24. H is not a subspace since H does not contain 0 .
25. Note that $(a, b, c, d) \notin H$ since $a^2 + b^2 + c^2 + d^2 > 0$. So H is a proper subset of \mathbb{R}^4 . Suppose $(x_1, y_1, z_1, w_1) \in H$ and $(x_2, y_2, z_2, w_2) \in H$. Then $(x_1 + x_2, y_1 + y_2, z_1 + z_2, w_1 + w_2) \in H$ since $a(x_1 + x_2) + b(y_1 + y_2) + c(z_1 + z_2) + d(w_1 + w_2) = 0 + 0 = 0$. Also, $\alpha(x_1, y_1, z_1, w_1) \in H$ since $a(\alpha x_1) + b(\alpha y_1) + c(\alpha z_1) + d(\alpha w_1) = \alpha \cdot 0 = 0$. Thus H is a proper subspace of \mathbb{R}^4 . (Or use Problem 23 with $A = (a \ b \ c \ d)$.)
26. Note that $(a_1, a_2, \dots, a_n) \notin H$ since $a_1^2 + a_2^2 + \dots + a_n^2 > 0$. So H is a proper subset of \mathbb{R}^n . Given (x_1, x_2, \dots, x_n) and $(y_1, y_2, \dots, y_n) \in H$ then $(x_1, x_2, \dots, x_n) + (y_1, y_2, \dots, y_n) \in H$ since $a_1(x_1 + y_1) + a_2(x_2 + y_2) + \dots + a_n(x_n + y_n) = 0 + 0 = 0$. $\alpha(x_1, x_2, \dots, x_n) \in H$ for all scalars α since $a_1(\alpha x_1) + a_2(\alpha x_2) + \dots + a_n(\alpha x_n) = \alpha \cdot 0 = 0$. Thus H is a proper subspace of \mathbb{R}^n . (Again Problem 23 with $A = (a_1 \ a_2 \ \dots \ a_n)$ also provides a solution.)
27. Suppose $\mathbf{v} = \mathbf{v}_1 + \mathbf{v}_2 \in H_1 + H_2$ and $\mathbf{w} = \mathbf{w}_1 + \mathbf{w}_2 \in H_1 + H_2$. Then $\mathbf{v} + \mathbf{w} = (\mathbf{v}_1 + \mathbf{w}_1) + (\mathbf{v}_2 + \mathbf{w}_2) \in H_1 + H_2$ since $\mathbf{v}_1 + \mathbf{w}_1 \in H_1$ and $\mathbf{v}_2 + \mathbf{w}_2 \in H_2$. $\alpha\mathbf{v} = \alpha\mathbf{v}_1 + \alpha\mathbf{v}_2 \in H_1 + H_2$ since $\alpha\mathbf{v}_1 \in H_1$ and $\alpha\mathbf{v}_2 \in H_2$. Then $H_1 + H_2$ is a subspace of V .
28. Suppose $\mathbf{v} = a\mathbf{v}_1 + b\mathbf{v}_2 \in H$ and $\mathbf{w} = c\mathbf{v}_1 + d\mathbf{v}_2 \in H$. Then $\mathbf{v} + \mathbf{w} = (a+c)\mathbf{v}_1 + (b+d)\mathbf{v}_2 \in H$. $\alpha\mathbf{v} = \alpha a\mathbf{v}_1 + \alpha b\mathbf{v}_2 \in H$. Then H is a subspace of \mathbb{R}^2 .

29. Since \mathbf{v}_1 and \mathbf{v}_2 are not colinear, $\mathbf{v}_1 \neq \alpha \mathbf{v}_2$ for any $\alpha \in \mathbb{R}$. Let $\mathbf{v}_1 = x_1\mathbf{i} + y_1\mathbf{j}$ and $\mathbf{v}_2 = x_2\mathbf{i} + y_2\mathbf{j}$. Then

$$\begin{vmatrix} x_1 & x_2 \\ y_1 & y_2 \end{vmatrix} \neq 0. \text{ That is, } \begin{pmatrix} x_1 & x_2 \\ y_1 & y_2 \end{pmatrix}^{-1} \text{ exists. Then, given any } (c, d) \in \mathbb{R}^2, \begin{pmatrix} a \\ b \end{pmatrix} = \begin{pmatrix} x_1 & x_2 \\ y_1 & y_2 \end{pmatrix}^{-1} \begin{pmatrix} c \\ d \end{pmatrix}.$$

Thus $H = \mathbb{R}^2$.

30. Suppose $\mathbf{v} = a_1\mathbf{v}_1 + a_2\mathbf{v}_2 + \cdots + a_n\mathbf{v}_n \in H$ and $\mathbf{w} = b_1\mathbf{v}_1 + b_2\mathbf{v}_2 + \cdots + b_n\mathbf{v}_n \in H$. Then $\mathbf{v} + \mathbf{w} = (a_1 + b_1)\mathbf{v}_1 + (a_2 + b_2)\mathbf{v}_2 + \cdots + (a_n + b_n)\mathbf{v}_n \in H$ and $\alpha\mathbf{v} = \alpha a_1\mathbf{v}_1 + \alpha a_2\mathbf{v}_2 + \cdots + \alpha a_n\mathbf{v}_n \in H$. Thus H is a subspace of V .

MATLAB 4.3

1. (a)

```
>> A = round( 10*(2*rand(4)-1)); % Part (a).
>> S = triu(A) + tril(A') % Notice that this is symmetric.
S =
-12     9    -9   -10
     9    -4    -9    -2
    -9   -9     2    -9
   -10   -2    -9    -4
```

(b)

```
>> B = round( 10*(2*rand(4)-1)); % Part (b).
>> T = triu(B) + tril(B')
T =
     8     1     4    -9
     1   -16     8     5
     4     8    10    -3
    -9     5    -3     6

>> a = 2*rand(1)-1
a =
    0.5128

>> a*S % Notice that this is symmetric.
ans =
-6.1539    4.6154   -4.6154   -5.1282
 4.6154   -2.0513   -4.6154   -1.0256
-4.6154   -4.6154    1.0256   -4.6154
-5.1282   -1.0256   -4.6154   -2.0513

>> S+T % This is also symmetric.
ans =
 -4    10    -5   -19
 10   -20    -1    3
 -5    -1    12   -12
-19     3   -12    2
```

This should be repeated several times.

- (c) We have verified the subspace properties for a few randomly selected matrices. This indicates that they may form a subspace, although it is not a proof.
- (d) We need to check the two rules from theorem 1. (i) Let $S = (s_{ij})$ and $T = (t_{ij})$ be any two symmetric matrices. Since S and T are symmetric, $s_{ij} = s_{ji}$ and $t_{ij} = t_{ji}$. If we write their sum as $S + T = (u_{ij})$. We need to check that $u_{ij} = u_{ji}$. Using the symmetry of S and T we have

$$u_{ij} = s_{ij} + t_{ij} = s_{ji} + t_{ji} = u_{ji},$$

which checks rule (i). (ii) Let $S = (s_{ij})$ be any symmetric matrix, and a be any scalar. If $aS = (u_{ij})$ then we need to check that $u_{ij} = u_{ji}$. Using symmetry of S we have

$$u_{ij} = as_{ij} = as_{ji} = u_{ji},$$

which verifies rule (ii).

Section 4.4

- Given any $\begin{pmatrix} x \\ y \end{pmatrix} \in \mathbb{R}^2$, we want to know if there are a_1 and a_2 such that $a_1 \begin{pmatrix} 1 \\ 2 \end{pmatrix} + a_2 \begin{pmatrix} 3 \\ 4 \end{pmatrix} = \begin{pmatrix} x \\ y \end{pmatrix}$.
 $\begin{pmatrix} 1 & 3 & x \\ 2 & 4 & y \end{pmatrix} \rightarrow \begin{pmatrix} 1 & 3 & x \\ 0 & -2 & -2x + y \end{pmatrix}$ can be backsolved, so a_1, a_2 exist.
- To see $a_1 \begin{pmatrix} 1 \\ 1 \end{pmatrix} + a_2 \begin{pmatrix} 2 \\ 1 \end{pmatrix} + a_3 \begin{pmatrix} 2 \\ 2 \end{pmatrix} = \begin{pmatrix} x \\ y \end{pmatrix}$ can be solved we reduce:
 $\begin{pmatrix} 1 & 2 & 2 & x \\ 1 & 1 & 2 & y \end{pmatrix} \rightarrow \begin{pmatrix} 1 & 2 & 2 & x \\ 0 & -1 & 0 & -x + y \end{pmatrix}$. Thus there are (many) solutions.
- $\text{span} \left\{ \begin{pmatrix} 1 \\ 1 \end{pmatrix}, \begin{pmatrix} 2 \\ 2 \end{pmatrix}, \begin{pmatrix} 5 \\ 5 \end{pmatrix} \right\} = \text{span} \left\{ \begin{pmatrix} 1 \\ 1 \end{pmatrix} \right\} = \left\{ \begin{pmatrix} r \\ r \end{pmatrix} : r \in \mathbb{R} \right\} \subset \mathbb{R}^2$. For example,
 $\begin{pmatrix} 1 \\ 0 \end{pmatrix} \notin \text{span} \left\{ \begin{pmatrix} 1 \\ 1 \end{pmatrix} \right\}$.
- $\begin{pmatrix} 1 & -1 & 5 & | & x \\ 2 & 2 & 2 & | & y \\ 3 & 3 & 3 & | & z \end{pmatrix} \rightarrow \begin{pmatrix} 1 & 0 & 3 & | & y/4 + x/2 \\ 0 & 1 & -2 & | & y/4 - x/2 \\ 0 & 0 & 0 & | & z - (3/2)y \end{pmatrix}$. Thus we can solve only if $z - (3/2)y = 0$, which is the equation of a plane passing through the origin. Hence the vectors do not span \mathbb{R}^3 .
- $\begin{pmatrix} 1 & 0 & 0 & | & x \\ 1 & 1 & 0 & | & y \\ 1 & 1 & 1 & | & z \end{pmatrix} \rightarrow \begin{pmatrix} 1 & 0 & 0 & | & x \\ 0 & 1 & 0 & | & y - x \\ 0 & 0 & 1 & | & z - x - y \end{pmatrix}$. Hence the vectors span \mathbb{R}^3 .
- Note that $\begin{pmatrix} 2 \\ 0 \\ 1 \end{pmatrix} = \begin{pmatrix} 3 \\ 1 \\ 2 \end{pmatrix} - \begin{pmatrix} 1 \\ 1 \\ 1 \end{pmatrix}$ and $\begin{pmatrix} 7 \\ 3 \\ 5 \end{pmatrix} = 2 \begin{pmatrix} 3 \\ 1 \\ 2 \end{pmatrix} + \begin{pmatrix} 1 \\ 1 \\ 1 \end{pmatrix}$. So $\begin{pmatrix} 2 \\ 0 \\ 1 \end{pmatrix}$ and $\begin{pmatrix} 7 \\ 3 \\ 5 \end{pmatrix}$ are in $\text{span} \left\{ \begin{pmatrix} 3 \\ 1 \\ 2 \end{pmatrix}, \begin{pmatrix} 1 \\ 1 \\ 1 \end{pmatrix} \right\}$. As $\begin{pmatrix} 3 \\ 1 \\ 2 \end{pmatrix}$ and $\begin{pmatrix} 1 \\ 1 \\ 1 \end{pmatrix}$ are not parallel, their span is a plane passing through the origin. Thus the vectors do not span \mathbb{R}^3 . (Or just use reduction as in 4 but with a 3×4 coefficient matrix.)
- Since $\det \begin{pmatrix} 1 & 1 & 0 \\ -1 & 1 & 0 \\ 2 & 2 & 1 \end{pmatrix} = 2 \neq 0$, the vectors span \mathbb{R}^3 , since $\begin{pmatrix} 1 & 1 & 0 \\ -1 & 1 & 0 \\ 2 & 2 & 1 \end{pmatrix} \begin{pmatrix} a \\ b \\ c \end{pmatrix} = \begin{pmatrix} x \\ y \\ z \end{pmatrix}$ can be solved.
- $\begin{pmatrix} 1 & -1 & 0 & | & x \\ -1 & 1 & 0 & | & y \\ 2 & 2 & 1 & | & z \end{pmatrix} \rightarrow \begin{pmatrix} 1 & -1 & 0 & | & x \\ 0 & 4 & 1 & | & z - 2x \\ 0 & 0 & 0 & | & x + y \end{pmatrix}$. Hence, $x + y = 0$, is necessary for any solutions. This is the equation of a plane passing through the origin. Thus the span of the vectors is not \mathbb{R}^3 .
- $1 - x$ and $3 - x^2$ do not span P_2 . For example, $x \notin \text{span} \{1 - x, 3 - x^2\}$. In fact when we try to solve $a(1 - x) + b(3 - x^2) = x$, we find $a + 3b = 0$, $-a = 1$, $-b = 0$ which are inconsistent equations.
- Let $ax^2 + bx + c \in \text{span} \{1 - x, 3 - x^2, x\}$. Trying to solve $\alpha(1 - x) + \beta(3 - x^2) + 8x = ax^2 + bx + c$ gives $\begin{pmatrix} 1 & 3 & 0 & | & c \\ -1 & 0 & 1 & | & b \\ 0 & -1 & 0 & | & a \end{pmatrix} \rightarrow \begin{pmatrix} 1 & 3 & 0 & | & c \\ 0 & 1 & 0 & | & -a \\ 0 & 3 & 1 & | & b+c \end{pmatrix} \rightarrow \begin{pmatrix} 1 & 0 & 0 & | & 3a+c \\ 0 & 1 & 0 & | & -a \\ 0 & 0 & 1 & | & 3a+b+c \end{pmatrix}$. So the equations are consistent and thus the polynomials $1 - x$, $3 - x^2$, and x span P_2 .

11. Show the equations $a_1 \begin{pmatrix} 2 & 1 \\ 0 & 0 \end{pmatrix} + a_2 \begin{pmatrix} 3 & -1 \\ 0 & 0 \end{pmatrix} + a_3 \begin{pmatrix} 0 & 0 \\ 3 & 1 \end{pmatrix} + a_4 \begin{pmatrix} 0 & 0 \\ 2 & 1 \end{pmatrix} = \begin{pmatrix} a & b \\ c & d \end{pmatrix}$ are consistent to conclude the given matrices span M_{22} .
12. They do not span M_{22} . For example, $\begin{pmatrix} 0 & 0 \\ 0 & 1 \end{pmatrix} \notin \text{span} \left\{ \begin{pmatrix} 1 & 0 \\ 1 & 0 \end{pmatrix}, \begin{pmatrix} 1 & 2 \\ 0 & 0 \end{pmatrix}, \begin{pmatrix} 4 & -1 \\ 3 & 0 \end{pmatrix}, \begin{pmatrix} -2 & 5 \\ 6 & 0 \end{pmatrix} \right\}$. (The equations $a_1 \begin{pmatrix} 1 & 0 \\ 1 & 0 \end{pmatrix} + a_2 \begin{pmatrix} 1 & 2 \\ 0 & 0 \end{pmatrix} + a_3 \begin{pmatrix} 4 & -1 \\ 3 & 0 \end{pmatrix} + a_4 \begin{pmatrix} -2 & 5 \\ 6 & 0 \end{pmatrix} = \begin{pmatrix} a & b \\ c & d \end{pmatrix}$ are not always consistent.)
13. $\begin{pmatrix} a & b & c \\ d & e & f \end{pmatrix} = a \begin{pmatrix} 1 & 0 & 0 \\ 0 & 0 & 0 \end{pmatrix} + b \begin{pmatrix} 0 & 1 & 0 \\ 0 & 0 & 0 \end{pmatrix} + c \begin{pmatrix} 0 & 0 & 1 \\ 0 & 0 & 0 \end{pmatrix} + d \begin{pmatrix} 0 & 0 & 0 \\ 1 & 0 & 0 \end{pmatrix} + e \begin{pmatrix} 0 & 0 & 0 \\ 0 & 1 & 0 \end{pmatrix} + f \begin{pmatrix} 0 & 0 & 0 \\ 0 & 0 & 1 \end{pmatrix}$. Thus they span M_{23} .
14. Suppose $a_1x^2 + b_1x + c_1$ and $a_2x^2 + b_2x + c_2$ span P_2 . Let $\mathbf{v}_i = (a_i, b_i, c_i)$ for $i = 1, 2$. Let $\alpha x^2 + \beta x + \gamma \in P_2$ be a nonzero polynomial such that $(\alpha, \beta, \gamma) \cdot \mathbf{v}_i = 0$. (Note that we can find such a nonzero polynomial since $(\alpha, \beta, \gamma) \cdot \mathbf{v}_i = 0$ is a homogeneous system of 2 equations and 3 unknowns.) Suppose that $\alpha x^2 + \beta x + \gamma = d_1(a_1x^2 + b_1x + c_1) + d_2(a_2x^2 + b_2x + c_2)$. Then $(\alpha, \beta, \gamma) \cdot (\alpha, \beta, \gamma) = (\alpha, \beta, \gamma) \cdot (d_1\mathbf{v}_1 + d_2\mathbf{v}_2) = 0$. But this is a contradiction since $(\alpha, \beta, \gamma) \neq 0$. Thus two polynomials cannot span P_2 .
15. Suppose $n + 1 > m$. Let $p_i(x) = a_{in}x^n + a_{i(n-1)}x^{n-1} + \cdots + a_{i0}$ for $i = 1, 2, \dots, m$. For each i , let $\mathbf{a}_i = (a_{in}, a_{i(n-1)}, \dots, a_{i0})$. By theorem 1.4.1, there is a nonzero solution $\mathbf{b} = (b_n, b_{n-1}, \dots, b_0)$ to the homogeneous system of equations $\mathbf{a}_i \cdot \mathbf{b} = 0$. Suppose $\mathbf{b} = \sum_{i=1}^m \alpha_i \mathbf{a}_i$. Then $\mathbf{b} \cdot \mathbf{b} = \mathbf{b} \cdot \left(\sum_{i=1}^m \alpha_i \mathbf{a}_i \right) = \sum_{i=1}^m \alpha_i (\mathbf{b} \cdot \mathbf{a}_i) = 0$. But this is a contradiction since \mathbf{b} is nonzero. Hence, if $q(x) = b_n x^n + b_{n-1} x^{n-1} + \cdots + b_0$, then $q(x)$ is not contained in the span of the $p_i(x)$. Thus $n + 1 \leq m$.
16. $\mathbf{u} = c_1\mathbf{v}_1 + c_2\mathbf{v}_2 + \cdots + c_k\mathbf{v}_k$ and $\mathbf{v} = d_1\mathbf{v}_1 + d_2\mathbf{v}_2 + \cdots + d_k\mathbf{v}_k$. Hence, $\mathbf{u} + \mathbf{v} = (c_1 + d_1)\mathbf{v}_1 + (c_2 + d_2)\mathbf{v}_2 + \cdots + (c_k + d_k)\mathbf{v}_k$, and $\alpha\mathbf{u} = (\alpha c_1)\mathbf{v}_1 + (\alpha c_2)\mathbf{v}_2 + \cdots + (\alpha c_k)\mathbf{v}_k$ are contained in $\text{span}\{\mathbf{v}_1, \mathbf{v}_2, \dots, \mathbf{v}_k\}$.
17. If $p(x) = a_n x^n + a_{n-1} x^{n-1} + \cdots + a_1 x + a_0 \cdot 1$, then $p(x)$ is written as a linear combination of $\{1, x, x^2, \dots, x^n\}$. Thus $\{1, x, x^2, \dots\}$ spans P .
18. Use induction on n . Suppose $\mathbf{v}_1 \in H$. By theorem 4.3.1, $\alpha\mathbf{v}_1 \in H$ for every scalar α . Thus $\text{span}\{\mathbf{v}_1\} \subseteq H$. Suppose $\text{span}\{\mathbf{v}_1, \mathbf{v}_2, \dots, \mathbf{v}_n\} \subseteq H$, and $\mathbf{v}_{n+1} \in H$. Let $\mathbf{v} = \alpha_1\mathbf{v}_1 + \alpha_2\mathbf{v}_2 + \cdots + \alpha_n\mathbf{v}_n + \alpha_{n+1}\mathbf{v}_{n+1}$. By assumption, $\alpha_1\mathbf{v}_1 + \cdots + \alpha_n\mathbf{v}_n \in H$, and theorem 4.3.1 implies $\alpha_{n+1}\mathbf{v}_{n+1} \in H$. Applying theorem 4.3.1 again gives $\mathbf{v} \in H$. By induction, if $\{\mathbf{v}_1, \mathbf{v}_2, \dots, \mathbf{v}_n\} \subseteq H$, then $\text{span}\{\mathbf{v}_1, \mathbf{v}_2, \dots, \mathbf{v}_n\} \subseteq H$.
19. Since $\mathbf{v}_2 = c\mathbf{v}_1$, then $\mathbf{v}_2 \in \text{span}\{\mathbf{v}_1\} = \text{span}\{\mathbf{v}_1, \mathbf{v}_2\}$. Thus, $\text{span}\{\mathbf{v}_1, \mathbf{v}_2\} = \{(x, y, z) : (x, y, z) = t(x_1, y_1, z_1), t \in \mathbb{R}\}$, which is a line passing through the origin.
20. Since $\mathbf{v}_1 \times \mathbf{v}_2$ is perpendicular to $\mathbf{v}_1, \mathbf{v}_2$, hence to the plane spanned by $\mathbf{v}_1, \mathbf{v}_2$, $\mathbf{v}_1 \times \mathbf{v}_2 \cdot \mathbf{x} = 0$ is the equation of a plane, which contains $a_1\mathbf{v}_1 + a_2\mathbf{v}_2$. Expanding the cross product shows $(y_1z_2 - z_1y_2)x + (z_1x_2 - x_1z_2)y + (x_1y_2 - x_2y_1)z = 0$, is an equation of a plane passing through the origin, which contains $H = \text{span}\{\mathbf{v}_1, \mathbf{v}_2\}$. Since $\mathbf{v}_1, \mathbf{v}_2$ are not parallel $\mathbf{v}_1 \times \mathbf{v}_2 \neq 0$ so this equation is the equation of a plane (and not just $0 = 0$).
21. Let $\mathbf{v} \in V$. Then there are scalars $\alpha_1, \alpha_2, \dots, \alpha_n$ such that $\mathbf{v} = \alpha_1\mathbf{v}_1 + \alpha_2\mathbf{v}_2 + \cdots + \alpha_n\mathbf{v}_n$ since $\text{span}\{\mathbf{v}_1, \dots, \mathbf{v}_n\} = V$. Let $\alpha_{n+1} = 0$. Then $\mathbf{v} = \alpha_1\mathbf{v}_1 + \alpha_2\mathbf{v}_2 + \cdots + \alpha_n\mathbf{v}_n + \alpha_{n+1}\mathbf{v}_{n+1}$. Thus $\mathbf{v}_1, \mathbf{v}_2, \dots, \mathbf{v}_{n+1}$ span V .

22. Consider $\begin{pmatrix} 1 & 0 \\ 0 & 1 \end{pmatrix}$, $\begin{pmatrix} 1 & 0 \\ 0 & -1 \end{pmatrix}$, $\begin{pmatrix} 0 & 1 \\ 1 & 0 \end{pmatrix}$, and $\begin{pmatrix} 0 & 1 \\ -1 & 0 \end{pmatrix}$. Note that each matrix is invertible.

$$\begin{aligned} \begin{pmatrix} a & b \\ c & d \end{pmatrix} &= \frac{a}{2} \left[\begin{pmatrix} 1 & 0 \\ 0 & 1 \end{pmatrix} + \begin{pmatrix} 1 & 0 \\ 0 & -1 \end{pmatrix} \right] - \frac{d}{2} \left[\begin{pmatrix} 1 & 0 \\ 0 & -1 \end{pmatrix} - \begin{pmatrix} 1 & 0 \\ 0 & 1 \end{pmatrix} \right] \\ &\quad + \frac{b}{2} \left[\begin{pmatrix} 0 & 1 \\ 1 & 0 \end{pmatrix} + \begin{pmatrix} 0 & 1 \\ -1 & 0 \end{pmatrix} \right] - \frac{c}{2} \left[\begin{pmatrix} 0 & 1 \\ -1 & 0 \end{pmatrix} - \begin{pmatrix} 0 & 1 \\ 1 & 0 \end{pmatrix} \right] \end{aligned}$$

23. Since each $\mathbf{v}_i \in \text{span}\{\mathbf{u}_1, \mathbf{u}_2, \dots, \mathbf{u}_n\}$, then $\text{span}\{\mathbf{v}_1, \mathbf{v}_2, \dots, \mathbf{v}_n\} \subseteq \text{span}\{\mathbf{u}_1, \mathbf{u}_2, \dots, \mathbf{u}_n\}$. Let $A =$

$$(a_{ij}), \mathbf{w} = \begin{pmatrix} \mathbf{u}_1 \\ \mathbf{u}_2 \\ \vdots \\ \mathbf{u}_n \end{pmatrix}, \text{ and } \mathbf{z} = \begin{pmatrix} \mathbf{v}_1 \\ \mathbf{v}_2 \\ \vdots \\ \mathbf{v}_n \end{pmatrix}. \text{ As } A\mathbf{w} = \mathbf{z} \text{ and } \det A \neq 0, \text{ we have } \mathbf{w} = A^{-1}\mathbf{z}. \text{ Let}$$

$A^{-1} = B = (b_{ij})$. For each \mathbf{u}_k , $\mathbf{u}_k = \sum_{i=1}^n b_{ik}\mathbf{v}_i \in \text{span}\{\mathbf{v}_1, \mathbf{v}_2, \dots, \mathbf{v}_n\}$. So $\text{span}\{\mathbf{u}_1, \mathbf{u}_2, \dots, \mathbf{u}_n\} \subseteq \text{span}\{\mathbf{v}_1, \mathbf{v}_2, \dots, \mathbf{v}_n\}$. Hence, $\text{span}\{\mathbf{u}_1, \mathbf{u}_2, \dots, \mathbf{u}_n\} = \text{span}\{\mathbf{v}_1, \mathbf{v}_2, \dots, \mathbf{v}_n\}$.

MATLAB 4.4

1. (a) See answers in Section 3.1.
 (b) This problem should be worked interactively. The following commands will produce the graph below.

```
>> u1 = [1;2]; u2 = [-2;3]; u3 = [5;4]; a = -2; b=2; c = -1;
>> combo(u1,u2,u3,a,b,c)
```

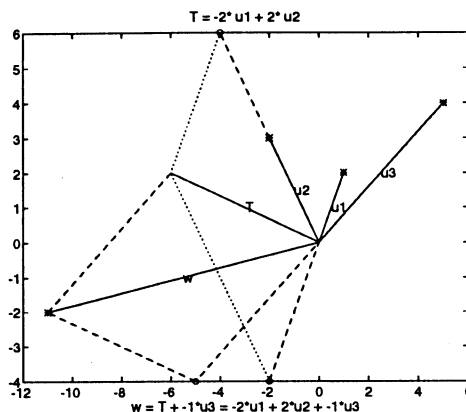

2. (a) (i) We wish to solve $c_1 \begin{pmatrix} 1 \\ 2 \end{pmatrix} + c_2 \begin{pmatrix} -1 \\ 3 \end{pmatrix} = \begin{pmatrix} 3 \\ 1 \end{pmatrix}$, which can be written as $\begin{pmatrix} 1c_1 + (-1)c_2 \\ 2c_1 + 3c_2 \end{pmatrix} = \begin{pmatrix} 3 \\ 1 \end{pmatrix}$.

This system of equations has the augmented matrix

$$\begin{pmatrix} 1 & -1 & 3 \\ 2 & 3 & 1 \end{pmatrix}$$

which is the same as $[\mathbf{u} \ \mathbf{v} \ | \ \mathbf{w}]$.

- (ii) We wish to solve $c_1 \begin{pmatrix} 2 \\ 4 \end{pmatrix} + c_2 \begin{pmatrix} -1 \\ 2 \end{pmatrix} = \begin{pmatrix} -1 \\ 6 \end{pmatrix}$, which can be written as $\begin{pmatrix} 2c_1 + (-1)c_2 \\ 4c_1 + 2c_2 \end{pmatrix} = \begin{pmatrix} -1 \\ 6 \end{pmatrix}$. This system of equations has the augmented matrix

$$\begin{pmatrix} 2 & -1 & -1 \\ 4 & 2 & 6 \end{pmatrix}$$

which is the same as $[\mathbf{u} \ \mathbf{v} \ | \ \mathbf{w}]$.

- (iii) We wish to solve $c_1 \begin{pmatrix} 1 \\ -1 \end{pmatrix} + c_2 \begin{pmatrix} 2 \\ 1 \end{pmatrix} = \begin{pmatrix} 8/5 \\ -5/3 \end{pmatrix}$, which can be written as $\begin{pmatrix} 1c_1 + 2c_2 \\ -1c_1 + 1c_2 \end{pmatrix} = \begin{pmatrix} 8/5 \\ -5/3 \end{pmatrix}$. This system of equations has the augmented matrix

$$\begin{pmatrix} 1 & 2 & 8/5 \\ -1 & 1 & -5/3 \end{pmatrix}$$

which is the same as $[\mathbf{u} \ \mathbf{v} \ | \ \mathbf{w}]$.

(b) This generates interactive graphics.

```
>> u = [1;2]; v = [-1; 3]; w = [3; 1];
>> lincomb(u,v,w)
```

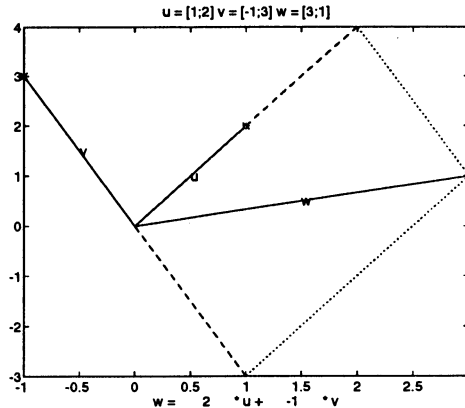

Two other pictures should be generated with sets (ii) and (iii).

3. (a) (i) We wish to solve

$$c_1 \begin{pmatrix} 1 \\ 1 \end{pmatrix} + c_2 \begin{pmatrix} -1 \\ 1 \end{pmatrix} + c_3 \begin{pmatrix} 3 \\ 0 \end{pmatrix} = \begin{pmatrix} 1 \\ -4 \end{pmatrix}$$

which can be written as

$$\begin{pmatrix} 1 & -1 & 3 \\ 1 & 1 & 0 \end{pmatrix} \begin{pmatrix} c_1 \\ c_2 \\ c_3 \end{pmatrix} = \begin{pmatrix} 1 \\ -4 \end{pmatrix}.$$

which has the augmented matrix $[\mathbf{v}_1 \ \mathbf{v}_2 \ \mathbf{v}_3 \ | \ \mathbf{w}]$. This system may be solved using MATLAB:

```
>> A = [ 1 -1 3 1; 1 1 0 -4]; % Enter the augmented matrix.
>> rref(A)
ans =
    1.0000         0    1.5000   -1.5000
         0    1.0000   -1.5000   -2.5000
```

The solution has c_3 arbitrary, and $c_1 = -1.5 - 1.5c_3$ and $c_2 = -2.5 + 1.5c_3$.

(ii) Similarly

```
>> A = [ 1 -2 5 -4; 2 3 4 -1];
>> rref(A)
ans =
    1.0000         0    3.2857   -2.0000
         0    1.0000   -0.8571    1.0000
```

The solution has c_3 arbitrary, and $c_1 = -2 - 3.2857c_3$ and $c_2 = 1 + .8571c_3$.

- (b) (i) If $c_3 = 0$ in system (a.i), then $c_1 = -1.5$ and $c_2 = -2.5$, so that $\mathbf{w} = -1.5\mathbf{v}_1 - 2.5\mathbf{v}_2$. If $c_3 = 0$ in system (a.ii), then $c_1 = -2$ and $c_2 = -1$, so that $\mathbf{w} = -2\mathbf{v}_1 + \mathbf{v}_2$.
- (ii) If $c_2 = 0$ in system (a.i), then $c_3 = 2.5/1.5 = 1.6667$, and $c_1 = -4$, so that $\mathbf{w} = -4\mathbf{v}_1 + 1.6667\mathbf{v}_3$. In system (a.ii), $c_3 = -1/.8571 = -1.1667$, and $c_1 = 1.8334$, so that $\mathbf{w} = 1.8334\mathbf{v}_1 - 1.1667\mathbf{v}_3$.

- (iii) If $c_1 = 0$, in system (a.i), then $c_3 = 1.5/(-1.5) = -1$, and $c_2 = -4$, so that $\mathbf{w} = -4\mathbf{v}_2 - \mathbf{v}_3$. In system (a.ii), $c_3 = 2/(-3.2857) = -0.6987$, and $c_2 = .4783$, so that $\mathbf{w} = .4783\mathbf{v}_2 - 0.6987\mathbf{v}_3$.
- (c) Here are the four plots produced by `combine2(v1,v2,v3,w)` for the data in (a)(ii) above: (note that \mathbf{v}_i is labelled \mathbf{u}_i in these plots).

```
>> v1=[1 2]'; v2=[-2 3]'; v3=[5 4]'; w=[-4 -1]';
>> combine2(v1,v2,v3,w)
>> print -deps fig443c.eps
```

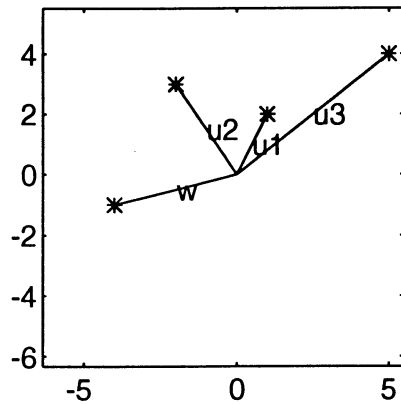

$$\mathbf{w} = -2 * \mathbf{u}_1 + 1 * \mathbf{u}_2$$

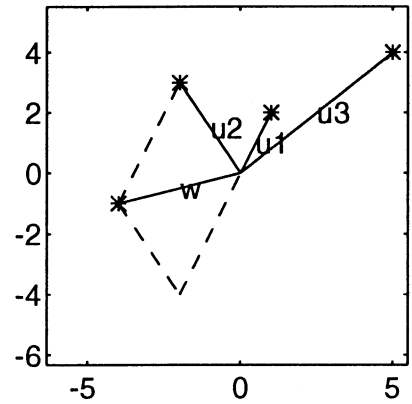

$$\mathbf{w} = 11/23 * \mathbf{u}_2 + -14/23 * \mathbf{u}_3$$

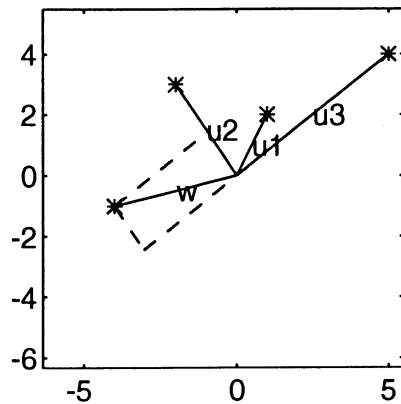

$$\mathbf{w} = 11/6 * \mathbf{u}_1 + -7/6 * \mathbf{u}_3$$

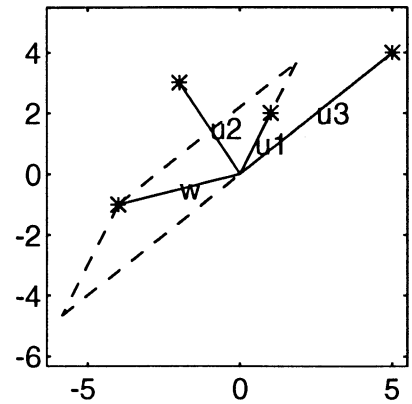

4. (a) The equation $\mathbf{w} = c_1\mathbf{v}_1 + c_2\mathbf{v}_2 + c_3\mathbf{v}_3$ is a system with augmented matrix.

$$\begin{pmatrix} 4 & 7 & 3 & 3 \\ 2 & 1 & -2 & -3 \\ 9 & -8 & 4 & 25 \end{pmatrix}$$

and variables c_1, c_2, c_3 . The definition of linear combination says the vector \mathbf{w} is a linear combination of the \mathbf{v} 's exactly when the equation (hence the system) has a solution.

(b) (i)

```
>> A = [ 4 7 3 3; 2 1 -2 -3; 9 -8 4 25];
>> rref(A)
ans =
     1     0     0     1
     0     1     0    -1
     0     0     1     2

>> c = ans(:,4)
c =
     1
    -1
     2
```

(ii)

```
>> A = [4 7 3 3; 2 0 -2 -3; 9 13 4 25];
>> rref(A)
ans =
     1     0    -1     0
     0     1     1     0
     0     0     0     1

>> % No solution exists
```

(iii)

```
>> A = [8 5 10 10.5; 5 -3 -3 2; -5 3 -5 -14; -9 5 10 3.5];
>> rref(A)
ans =
     1     0     0     0
     0     1     0     0
     0     0     1     0
     0     0     0     1

>> % No solution exists.
```

(iv)

```
>> A = [8 5 10 1; 5 -3 -3 1; -5 3 -5 1; -9 5 10 1];
>> rref(A)
ans =
     1     0     0     0
     0     1     0     0
     0     0     1     0
     0     0     0     1

>> % No solution.
```

(v)

```
>> A = [4 3 5 -3 -19; 5 8 2 -7 -9; 3 -5 11 0 -46; -9 -1 -17 8 74];
>> rref(A)
ans =
     1     0     2     0    -7
     0     1    -1     0     5
     0     0     0     1     2
     0     0     0     0     0
```

```
>> c = [-7; 5; 0; 2]           % Pick c3 = 0.
c =
    -7
     5
     0
     2
```

(vi)

```
>> A = [ 4 7 3 1; 2 1 -2 1; 9 -8 4 1];
>> rref(A)
ans =
    1.0000         0         0    0.2656
         0    1.0000         0    0.0754
         0         0    1.0000   -0.1967
```

```
>> c = ans(:,4)
c =
    0.2656
    0.0754
   -0.1967
```

(vii)

```
>> A = [1 -1 1 3; 2 0 -1 2];
>> rref(A)
ans =
    1.0000         0   -0.5000    1.0000
         0    1.0000   -1.5000   -2.0000

>> c = [1; -2; 0]           % Pick c3 = 0.
c =
     1
    -2
     0
```

- (c) Since there was a solution to the system, \mathbf{w} was in the span of the \mathbf{v} 's in parts (i), (v), (vi) and (vii). Since there was no solution to the system, \mathbf{w} was not in the span of the \mathbf{v} 's in parts (ii), (iii) and (iv). In each case where a solution existed, $\mathbf{w} - c(1)*\mathbf{v}_1 - c(2)*\mathbf{v}_2 - \dots$ will give $\mathbf{0}$ up to roundoff error.

5. (a) (i)

```
>> A = [ 4 7 3; 2 1 -2; 9 -8 4];
>> rref(A)
ans =
     1     0     0
     0     1     0
     0     0     1
```

(ii)

```
>> A = [ 9 5 -10 3; -9 7 4 5; 5 -7 7 5];
>> rref(A)
ans =
    1.0000         0         0    1.0338
         0    1.0000         0    1.3092
         0         0    1.0000    1.2850
```

Since in both cases, the row echelon form of A has no zero rows, any system of the form $[A \ \mathbf{w}]$ will have a solution. Since solutions of this system tell us how to write \mathbf{w} as a linear combination of the vectors $\{\mathbf{v}_1, \mathbf{v}_2, \dots, \mathbf{v}_k\}$, if the system has a solution, then \mathbf{w} will be in the span of this set. Since this system has a solution for any \mathbf{w} in \mathbb{R}^n , the set will span all of \mathbb{R}^3 .

(b) (i)

```
>> A = [10 9 -4; 0 -9 8; -5 0 1; -8 -2 -1];
>> rref(A)
ans =
     1     0     0
     0     1     0
     0     0     1
     0     0     0
```

(ii)

```
>> A = [ 4 3 5 3; 5 8 2 -7; 3 -5 11 0; -9 -1 -17 8];
>> rref(A)
ans =
     1     0     2     0
     0     1    -1     0
     0     0     0     1
     0     0     0     0
```

(iii)

```
>> A = [9 5 14 -4; -9 7 -2 16; 5 7 12 2];
>> rref(A)
ans =
     1     0     1    -1
     0     1     1     1
     0     0     0     0
```

In each of these systems, the row echelon form of A has a zero row, so it is possible to pick a \mathbf{w} so that there will be no solution. Since the system cannot be solved, \mathbf{w} cannot be written as a linear combination of this set. This means that \mathbf{w} is not in the span, so the span is not all of \mathbb{R}^n . By experimentation, one can find such a \mathbf{w} , for example: for sets (i) and (ii), $\mathbf{w} =$

$$\begin{pmatrix} 1 \\ 0 \\ 0 \\ 0 \end{pmatrix} \text{ is not in the span and for set (iii) } \mathbf{w} = \begin{pmatrix} 1 \\ 0 \\ 0 \end{pmatrix}.$$

6. See the solution for problem 2 in Section 1.8. The matrices in (i), (iv), and (v) were invertible, and when they were reduced to row echelon form, they had no zero rows. The matrices in (ii), (iii), and (vi) were not invertible, and had zero rows in their row echelon form. If the row echelon form of A has no zero rows, then the row echelon form of $[A \ \mathbf{w}]$ will always be consistent, and so will always have a solution. This means that the columns of A will span all of \mathbb{R}^n . A square matrix is invertible if and only if its columns span \mathbb{R}^n .

7. (a) To solve this problem, we enter the matrix of \mathbf{v}_i 's and reduce it to row echelon form.

```
>> A = [ 3 -2 7 14 1; -7 0 2 -5 -5; 4 -7 9 27 0; -2 2 1 -5 -1];
>> rref(A)
ans =
     1     0     0     1     0
     0     1     0    -2     0
     0     0     1     1     0
     0     0     0     0     1
```

Since there are no zero rows, the system $[A \mathbf{w}]$ will always have a solution for any \mathbf{w} . This means the set will span all of \mathbb{R}^4 . Since c_4 may be chosen arbitrarily, there will be always an infinite number of solutions.

(b) For the first \mathbf{w} :

(i)

```
>> w = [23; -15; 33; -5];
>> rref([ A w])
ans =
     1     0     0     1     0     2
     0     1     0    -2     0    -1
     0     0     1     1     0     2
     0     0     0     0     1     1
```

The solution has c_4 arbitrary as no pivot in column 4 and $c_1 = 2 - c_4$, $c_2 = -1 + 2c_4$, $c_3 = 2 - c_4$, and $c_5 = 1$.

(ii) With $c_4 = 0$, $\mathbf{w} = 2\mathbf{v}_1 - 1\mathbf{v}_2 + 2\mathbf{v}_3 + 1\mathbf{v}_5$.

(iii) To verify this, recall that \mathbf{v}_i is the same as $A(:, i)$.

```
>> 2*A(:,1) - 1*A(:,2) + 2*A(:,3) + 1*A(:,5) % This should be w.
ans =
    23
   -15
    33
    -5
```

For the second \mathbf{w} :

(i)

```
>> w = [-13; 18; -45; 18];
>> rref([ A w])
ans =
     1     0     0     1     0    -3
     0     1     0    -2     0     6
     0     0     1     1     0     1
     0     0     0     0     1     1
```

The solution is c_4 is arbitrary, and $c_1 = -3 - c_4$, $c_2 = 6 + 2c_4$, $c_3 = 1 - c_4$, and $c_5 = 1$.

(ii) With $c_4 = 0$, $\mathbf{w} = -3\mathbf{v}_1 + 6\mathbf{v}_2 + 1\mathbf{v}_3 + 1\mathbf{v}_5$.

(iii)

```
>> -3*A(:,1) + 6*A(:,2) + 1*A(:,3) + 1*A(:,5) % This should be w.
ans =
    -13
     18
    -45
     18
```

(c) The fourth vector was not needed, because we could always choose c_4 to be zero. This can be recognized by the fact that the fourth column had no pivot.

(d) The matrix formed from the new set will be:

```
>> B = [ 3 -2 7 1; -7 0 2 -5; 4 -7 9 0; -2 2 1 -1];
>> rref(B)
ans =
     1     0     0     0
     0     1     0     0
     0     0     1     0
     0     0     0     1
```

Since this has no rows of zeros, any system of the form $[B \ w]$ will have a solution. Since there are no columns without a pivot, this solution will be unique. This corresponds to the statement that any vector w will be in the span of columns of the new matrix and that the coefficients for the linear combination will be unique.

(e) First enter the matrix of vectors:

```
>> A = [ 10 0 -10 -6 32; 8 2 -4 -7 32; -5 7 19 1 -5];
>> rref(A)
ans =
     1     0     -1     0     2
     0     1     2     0     1
     0     0     0     1    -2
```

As above, for any w in \mathbb{R}^3 , the system $[A \ w]$ will have a solution, and the coefficients c_3 and c_5 may be chosen arbitrarily.

For the first w in (b)

(i)

```
>> w = [26; 31; 17];
>> rref( [A w] )
ans =
     1     0     -1     0     2     2
     0     1     2     0     1     4
     0     0     0     1    -2    -1
```

The solution has c_3 and c_5 arbitrary and $c_1 = 2+1c_3-2c_5$, $c_2 = 4-2c_3-1c_5$ and $c_4 = -1+2c_5$.

(ii) With c_3 and c_5 chosen to be zero, $w = 2v_1 + 4v_2 - 1v_4$. To verify this:

(iii)

```
>> 2*A(:,1) + 4*A(:,2) - 1*A(:,4) % This should be w.
ans =
    26
    31
    17
```

For the second w in (b)

```
>> w = [2; 20; 52];
>> rref( [A w] )
ans =
     1     0    -1     0     2    -1
     0     1     2     0     1     7
     0     0     0     1    -2    -2
```

The solution has c_3 and c_5 arbitrary and $c_1 = -1 + 1c_3 - 2c_5$, $c_2 = 7 - 2c_3 - 1c_5$ and $c_4 = -2 + 2c_5$.

- (ii) With c_3 and c_5 chosen to be zero, $w = -1v_1 + 7v_2 - 2v_4$. To verify this:
 (iii)

```
>> -1*A(:,1) + 7*A(:,2) - 2*A(:,4)      % This should be w.
ans =
     2
    20
    52
```

For (c): the third and fifth vectors are not needed. We may span all of \mathbb{R}^3 with the first, second and fourth vectors. To check this, enter the matrix formed by the new set:

```
>> B = [10 0 -6; 8 2 -7; -5 7 1];
>> rref(B)
ans =
     1     0     0
     0     1     0
     0     0     1
```

As in (d) above, there are no rows of zeros, and every column has a pivot, so the system $[B \ w]$ will always have a unique solution.

8. (a)

```
>> A = [ 20; 10; 20; 10; 0];          % Mix A has 20 parts cement, 10 parts water,
                                     % 20 parts sand, 10 parts gravel, and
                                     % 0 parts fly ash.
>> B = [ 18; 10; 25; 5; 2];          % Mix B.
>> C = [ 12; 10; 15; 15; 8];          % Mix C.
>> v = [ 1000; 200; 1000; 500; 300]; % The custom mix that we want, in grams.
>> rref([ A B C v])                  % Solve c_1 A + c_2 B + c_3 C = v.
ans =
     1     0     0     0
     0     1     0     0
     0     0     1     0
     0     0     0     1
     0     0     0     0
```

Since the fourth row has zeros on the left and a one on the right, there is no solution. Hence, this mix cannot be made.

- (b) Let v be the vector of components in our custom mix. That the total weight is 5000 means

$$v_1 + v_2 + v_3 + v_4 + v_5 = 5000.$$

The amount of cement is $v_1 = 1250$. The ratio of water to cement is 2 to 3, or $v_2/v_1 = 2/3$, which can be written as $v_2 = \frac{2}{3}v_1 = 833.33$. The amount of sand and gravel tells us $v_3 = 1500$, and $v_4 = 1500$. Plugging these values into the equation for the total weight, and solving for v_5 , the fly ash, we get:

$$1250 + 833.333 + 1500 + 1500 + v_5 = 5000,$$

whose solution is $v_5 = -83.3333$. Since it is impossible to have a negative amount of something, this cannot be made as a custom blend.

9. (a) The vector \mathbf{u} represents the polynomial whose constant term is -5 , linear term is 3, x^2 term is 0 and whose x^3 term is 1. This is the polynomial q .
 (b) We add polynomials by adding their terms together:

$$r(x) = (2*5 - 3*1)x^3 + (2*4 - 3*0)x^2 + (2*3 - 3*3)x + (2*1 - 3*(-5)) = 7x^3 + 8x^2 - 3x + 17$$

```
>> v = [ 1; 3; 4; 5]; u = [-5; 3; 0; 1];
>> w = 2*v - 3*u
w =
    17
    -3
     8
     7
```

The vector w represents the polynomial $r(x)$ because the constant term of $r(x)$ is 17, its x term is -3 , its x^2 term is 8 and its x^3 term is 7.

- (c) Polynomials of degree two may be represented by vectors in \mathbb{R}^3 .

```
>> p = [ -1; 2; 0]; % This represents p(x).
>> v1 = [ -2; 0; -5]; % This represents the first poly. in the set.
>> v2 = [ 8; -9; -6]; % The second poly.
>> v3 = [ 9; -7; -1]; % The third poly.
>> rref([ v1 v2 v3 p]) % Reduce the augmented matrix.
ans =
     1     0     0     1
     0     1     0    -1
     0     0     1     1
```

Yes, $p(x)$ is in the span of this set.

$$p(x) = 1(-5x^2 - 2) - 1(-6x^2 - 9x + 8) + 1(-x^2 - 7x + 9)$$

This set does span all of P_2 since the system with augmented matrix $[v_1 \ v_2 \ v_3 \ | \ b]$ would have a solution for any right hand side.

- (d) As above, we will represent P_3 by vectors in \mathbb{R}^4 .

```
>> p = [ -17; 29; 3; 1];
>> v1 = [-8; 8; -7; -2]; v2 = [5; 3; 9; 7]; v3 = [-3; -1; 6; -7];
>> rref([ v1 v2 v3 p])
ans =
     1     0     0     3
     0     1     0     2
     0     0     1     1
     0     0     0     0
```

Yes, $p(x)$ is in the span of this set: $p(x) = 3p_1(x) + 2p_2(x) + 1p_3(x)$ where $p_i(x)$ has the coefficients in v_i . This set does not span all of P_3 . Since there is a row of zeros in the row echelon form of

$A = [v_1 \ v_2 \ v_3]$, it will be possible to pick a vector (which represents a polynomial) so that the system $[A \ p]$ does not have a solution.

(e)

```
>> A = [2 1 1 1; -1 3 2 0; 0 1 1 -1; 1 1 2 0];
>> rref(A)
ans =
     1     0     0     0
     0     1     0     0
     0     0     1     0
     0     0     0     1
```

Since the matrix of vectors representing these polynomials reduces to a row echelon form with no zero rows, this set will span all of P_3 .

10. (a) The matrix $C = A - 2B$ is

$$\begin{pmatrix} a_1 - 2a_2 & c_1 - 2c_2 & e_1 - 2e_2 \\ b_1 - 2b_2 & d_1 - 2d_2 & f_1 - 2f_2 \end{pmatrix}.$$

C is represented by the vector

$$\begin{pmatrix} a_1 - 2a_2 \\ b_1 - 2b_2 \\ c_1 - 2c_2 \\ d_1 - 2d_2 \\ e_1 - 2e_2 \\ f_1 - 2f_2 \end{pmatrix},$$

which is the sum $v + 2w$.

(b)

```
>> w = [1; 29; 3; -17]           % This vector represents the first matrix.
w =
     1
    29
     3
   -17

>> v1 = [-2; 8; -7; 8];         % Next, enter the set of vectors.
>> v2 = [ 7; 3; 9; 5];
>> v3 = [-7; -1; 6; -3];
>> rref([ v1 v2 v3 w])          % Solve c1 v1 + c2 v2 + c3 v3 = w.
ans =
     1     0     0     0
     0     1     0     0
     0     0     1     0
     0     0     0     1
```

This system does not have a solution, so the first matrix is not in the span of the others. From this we can conclude that this set does not span all of M_{22} , since we have found an element of M_{22} that is not in their span.

(c)

```
>> w = [4; -2; 7; -6; -10; 1]; % The first matrix.
>> v1 = [6; 9; 5; 3; -1; -1]; % The set of matrices.
>> v2 = [6; 10; 4; 9; 4; 7]; v3 = [-4; -8; 1; -2; 0; 2];
>> v4 = [ 8; 7; -1; 4; 5; 6]; v5 = [ 4; 8; 5; 0; -10; -1];
>> v6 = [ -9; 3; 4; 4; 0; -6];
>> rref( [v1 v2 v3 v4 v5 v6 w])
ans =
     1     0     0     0     0     0     1
     0     1     0     0     0     0    -1
     0     0     1     0     0     0     2
     0     0     0     1     0     0     1
     0     0     0     0     1     0     1
     0     0     0     0     0     1     0
```

Yes, w is in the span,

$$w = 1v_1 - 1v_2 + 2v_3 + 1v_4 + 1v_5.$$

This set does span all of M_{23} because the system above would have a solution for any right hand side.

(d)

```
>> v1 = [1; -1; 0; 2]; v2 = [ 1; 3; 1; 1];
>> v3 = [ 2; 2; 1; 1]; v4 = [ 0; 0; -1; 1];
>> rref([ v1 v2 v3 v4])
ans =
     1     0     0     0
     0     1     0     0
     0     0     1     0
     0     0     0     1
```

Since there are no zero rows, this system would have a solution for any right hand side. This means that we can write anything in M_{22} as a linear combination of these matrices, so they do span M_{22} .

Section 4.5

1. $\begin{pmatrix} 1 \\ 2 \end{pmatrix} \neq \alpha \begin{pmatrix} -1 \\ -3 \end{pmatrix}$ so linearly independent.
2. $\begin{pmatrix} 2 & 4 & | & 0 \\ -1 & -2 & | & 0 \\ 4 & 7 & | & 0 \end{pmatrix} \rightarrow \begin{pmatrix} 1 & 2 & | & 0 \\ 0 & 0 & | & 0 \\ 0 & -1 & | & 0 \end{pmatrix} \rightarrow \begin{pmatrix} 1 & 0 & | & 0 \\ 0 & 0 & | & 0 \\ 0 & 1 & | & 0 \end{pmatrix}$; Linearly independent, as only the trivial solution.
3. $\begin{pmatrix} 2 & 4 & | & 0 \\ -1 & -2 & | & 0 \\ 4 & 8 & | & 0 \end{pmatrix} \rightarrow \begin{pmatrix} 1 & 2 & | & 0 \\ 0 & 0 & | & 0 \\ 0 & 0 & | & 0 \end{pmatrix}$; Linearly dependent, as $-2 \begin{pmatrix} 2 \\ -1 \\ 2 \end{pmatrix} + 1 \begin{pmatrix} 4 \\ -2 \\ 8 \end{pmatrix} = \mathbf{0}$.
4. $\begin{pmatrix} -2 \\ 3 \end{pmatrix} \neq a \begin{pmatrix} 4 \\ 7 \end{pmatrix}$ so linearly independent.
5. Linearly dependent, as 3 vectors in \mathbb{R}^2 always dependent (Theorem 2).
6. $\begin{vmatrix} 1 & 0 & 1 \\ 0 & 1 & 1 \\ 1 & 1 & 0 \end{vmatrix} = -2$; Linearly independent, (Theorem 5.)
7. $\begin{vmatrix} 1 & 0 & 0 \\ 0 & 1 & 0 \\ 0 & 0 & 1 \end{vmatrix} = 1$; Linearly independent.
8. $\begin{vmatrix} -3 & 7 & 1 \\ 4 & -1 & 2 \\ 2 & 3 & 8 \end{vmatrix} = -140$; Linearly independent.
9. $\begin{vmatrix} -3 & 7 & 1 \\ 4 & -1 & 1 \\ 2 & 3 & 8 \end{vmatrix} = -163$; Linearly independent.
10. $\begin{vmatrix} 1 & 3 & 0 & 5 \\ -2 & 0 & 4 & 0 \\ 1 & 2 & -1 & 3 \\ 1 & -2 & -1 & -1 \end{vmatrix} = 0$; Linearly dependent.
11. $\begin{vmatrix} 1 & 3 & 0 & 5 \\ -2 & 0 & 4 & 0 \\ 1 & 2 & -1 & 3 \\ 1 & -2 & 1 & -1 \end{vmatrix} = 4$; Linearly independent.
12. Linearly dependent, as 4 vectors in \mathbb{R}^3 always dependent (Theorem 2).
13. $c_1(1-x) + c_2x = 0$; $c_1 + (c_2 - c_1)x = 0 \Rightarrow c_1 = 0$; $c_2 - c_1 = 0$; So $c_1 = c_2$. Linearly independent.
14. $-c_1x + c_2(x^2 - 2x) + c_3(3x + 5x^2) = 0$; $(-c_1 - 2c_2 + 3c_3)x + (c_2 + 5c_3)x^2 = 0$; $\begin{pmatrix} -1 & -2 & 3 & | & 0 \\ 0 & 1 & 5 & | & 0 \end{pmatrix} \rightarrow \begin{pmatrix} 1 & 0 & -13 & | & 0 \\ 0 & 1 & 5 & | & 0 \end{pmatrix} \Rightarrow$ Linearly dependent.
15. $c_1(1-x) + c_2(1+x) + c_3x^2 = 0$; $(c_1 + c_2) + (-c_1 + c_2)x + c_3x^2 = 0$; $\begin{pmatrix} 1 & 1 & 0 & | & 0 \\ -1 & 1 & 0 & | & 0 \\ 0 & 0 & 1 & | & 0 \end{pmatrix} \rightarrow \begin{pmatrix} 1 & 1 & 0 & | & 0 \\ 0 & 2 & 0 & | & 0 \\ 0 & 0 & 1 & | & 0 \end{pmatrix} \rightarrow \begin{pmatrix} 1 & 0 & 0 & | & 0 \\ 0 & 1 & 0 & | & 0 \\ 0 & 0 & 1 & | & 0 \end{pmatrix} \Rightarrow$ Linearly independent.

$$16. c_1x + c_2(x^2 - x) + c_3(x^3 - x) = 0; (c_1 - c_2 - c_3)x + c_2x^2 + c_3x^3 = 0; \begin{pmatrix} 0 & -1 & -1 & | & 0 \\ 0 & 1 & 0 & | & 0 \\ 0 & 0 & 1 & | & 0 \end{pmatrix} \rightarrow \begin{pmatrix} 1 & 0 & 0 & | & 0 \\ 0 & 1 & 0 & | & 0 \\ 0 & 0 & 1 & | & 0 \end{pmatrix} \Rightarrow$$

Linearly independent.

$$17. 2c_1x + c_2(x^3 - 3) + c_3(1 + x - 4x^3) + c_4(x^3 + 18x - 9) = 0;$$

$$(-3c_2 + c_3 - 9c_4) + (2c_1 + c_3 + 18c_4)x + (c_2 - 4c_3 + c_4)x^3 = 0; \begin{pmatrix} 0 & -3 & 1 & -9 & | & 0 \\ 2 & 0 & 1 & 18 & | & 0 \\ 0 & 1 & -4 & 1 & | & 0 \end{pmatrix} \rightarrow \begin{pmatrix} 0 & 0 & -11 & -6 & | & 0 \\ 1 & 0 & 1/2 & 9 & | & 0 \\ 0 & 1 & -4 & 1 & | & 0 \end{pmatrix} \rightarrow$$

$$\begin{pmatrix} 0 & 0 & 1 & 6/11 & | & 0 \\ 1 & 0 & 0 & 96/11 & | & 0 \\ 0 & 1 & 0 & 35/11 & | & 0 \end{pmatrix} \Rightarrow \text{Linearly dependent.}$$

$$18. c_1 \begin{pmatrix} 2 & -1 \\ 4 & 0 \end{pmatrix} + c_2 \begin{pmatrix} 0 & -3 \\ 1 & 5 \end{pmatrix} + c_3 \begin{pmatrix} 4 & 1 \\ 7 & -5 \end{pmatrix} = \begin{pmatrix} 0 & 0 \\ 0 & 0 \end{pmatrix} \text{ or } \begin{pmatrix} 2c_1 + 4c_3 - c_1 - 3c_2 + c_3 & -c_1 - 3c_2 + c_3 \\ 4c_1 + c_2 + 7c_3 & 5c_2 - 5c_3 \end{pmatrix} = \begin{pmatrix} 0 & 0 \\ 0 & 0 \end{pmatrix}.$$

$$\begin{pmatrix} 2 & 0 & 4 & | & 0 \\ -1 & -3 & 1 & | & 0 \\ 4 & 1 & 7 & | & 0 \\ 0 & 5 & -5 & | & 0 \end{pmatrix} \rightarrow \begin{pmatrix} 1 & 0 & 2 & | & 0 \\ 0 & -3 & 3 & | & 0 \\ 0 & 1 & -1 & | & 0 \\ 0 & 5 & -5 & | & 0 \end{pmatrix} \rightarrow \begin{pmatrix} 1 & 0 & 2 & | & 0 \\ 0 & 1 & -1 & | & 0 \\ 0 & 0 & 0 & | & 0 \\ 0 & 0 & 0 & | & 0 \end{pmatrix} \Rightarrow \text{Linearly dependent.}$$

$$19. c_1 \begin{pmatrix} 1 & -1 \\ 0 & 6 \end{pmatrix} + c_2 \begin{pmatrix} -1 & 0 \\ 3 & 1 \end{pmatrix} + c_3 \begin{pmatrix} 1 & 1 \\ -1 & 2 \end{pmatrix} + c_4 \begin{pmatrix} 0 & 1 \\ 1 & 0 \end{pmatrix} = \begin{pmatrix} 0 & 0 \\ 0 & 0 \end{pmatrix}. \text{ As in Solution 18.}$$

$$\begin{pmatrix} 1 & -1 & 1 & 0 & | & 0 \\ -1 & 0 & 1 & 1 & | & 0 \\ 0 & 3 & -1 & 1 & | & 0 \\ 6 & 1 & 2 & 0 & | & 0 \end{pmatrix} \rightarrow \begin{pmatrix} 1 & -1 & 1 & 0 & | & 0 \\ 0 & -1 & 2 & 1 & | & 0 \\ 0 & 3 & -1 & 1 & | & 0 \\ 0 & 7 & -4 & 0 & | & 0 \end{pmatrix} \rightarrow \begin{pmatrix} 1 & 0 & -1 & -1 & | & 0 \\ 0 & 1 & -2 & -1 & | & 0 \\ 0 & 0 & 5 & 4 & | & 0 \\ 0 & 0 & 10 & 7 & | & 0 \end{pmatrix} \rightarrow \begin{pmatrix} 1 & 0 & 0 & -1/5 & | & 0 \\ 0 & 1 & 0 & 3/5 & | & 0 \\ 0 & 0 & 1 & 4/5 & | & 0 \\ 0 & 0 & 0 & 1 & | & 0 \end{pmatrix} \rightarrow$$

$$\begin{pmatrix} 1 & 0 & 0 & 0 & | & 0 \\ 0 & 1 & 0 & 0 & | & 0 \\ 0 & 0 & 1 & 0 & | & 0 \\ 0 & 0 & 0 & 1 & | & 0 \end{pmatrix} \Rightarrow \text{Linearly independent.}$$

$$20. c_1 \begin{pmatrix} -1 & 0 \\ 1 & 2 \end{pmatrix} + c_2 \begin{pmatrix} 2 & 3 \\ 7 & -4 \end{pmatrix} + c_3 \begin{pmatrix} 8 & -5 \\ 7 & 6 \end{pmatrix} + c_4 \begin{pmatrix} 4 & -1 \\ 2 & 3 \end{pmatrix} + c_5 \begin{pmatrix} 2 & 3 \\ -1 & 4 \end{pmatrix} = \begin{pmatrix} 0 & 0 \\ 0 & 0 \end{pmatrix}. \text{ Four homogeneous equations and five unknowns } \Rightarrow \text{Linearly dependent.}$$

$$21. c_1 \sin x + c_2 \cos x = 0; \text{ Set } x = 0 \Rightarrow c_2 = 0; \text{ Then } c_1 \text{ must also be } 0. \Rightarrow \text{Linearly independent.}$$

$$22. c_1x + c_2\sqrt{x} + c_3\sqrt[3]{x} = 0; x = 1 \Rightarrow c_1 + c_2 + c_3 = 0; x = 1/64 \Rightarrow \frac{1}{64}c_1 + \frac{1}{8}c_2 + \frac{1}{4}c_3 = 0;$$

$$x = 1/729 \Rightarrow \frac{1}{729}c_1 + \frac{1}{27}c_2 + \frac{1}{9}c_3 = 0; \begin{vmatrix} 1 & 1 & 1 \\ 1/64 & 1/8 & 1/4 \\ 1/729 & 1/27 & 1/9 \end{vmatrix} \neq 0 \Rightarrow \text{Linearly independent.}$$

$$23. \begin{vmatrix} a & c \\ b & d \end{vmatrix} = ad - bc = 0, \text{ by Theorem 5.} \quad 24. \begin{vmatrix} a_{11} & a_{12} & a_{13} \\ a_{21} & a_{22} & a_{23} \\ a_{31} & a_{32} & a_{33} \end{vmatrix} = 0, \text{ see Solution 1.4.16.}$$

$$25. \begin{pmatrix} 1 & 2 & 3 \\ 2 & -1 & \alpha \\ 3 & 4 & 4 \end{pmatrix} \rightarrow \begin{pmatrix} 1 & 2 & 3 \\ 0 & -5 & \alpha - 6 \\ 0 & -2 & -5 \end{pmatrix} \rightarrow \begin{pmatrix} 1 & 2 & 3 \\ 0 & -5 & \alpha - 6 \\ 0 & 0 & -\frac{2}{5}\alpha - \frac{13}{5} \end{pmatrix} \Rightarrow 2\alpha + 13 = 0 \Rightarrow \alpha = -13/2.$$

$$26. \text{ Note that } -2 \begin{pmatrix} 2 \\ -3 \\ 1 \end{pmatrix} = \begin{pmatrix} -4 \\ 6 \\ -2 \end{pmatrix}. \text{ Thus the set of vectors is linearly dependent for all real } \alpha.$$

27. If $A = (\mathbf{v}_1 \mathbf{v}_2 \cdots \mathbf{v}_n)$, then $A\mathbf{c} = 0$ says $c_1 \mathbf{v}_1 + c_2 \mathbf{v}_2 + \cdots + c_n \mathbf{v}_n = 0$. Hence $A\mathbf{c} = 0$ has a non-trivial solution if and only if $\mathbf{v}_1, \dots, \mathbf{v}_n$ dependent by the definition of dependence.
28. If $\mathbf{v}_1, \dots, \mathbf{v}_n$ are linearly dependent, then there exists a nontrivial solution (c_1, \dots, c_n) of $c_1 \mathbf{v}_1 + \cdots + c_n \mathbf{v}_n = 0$. Then $(c_1, \dots, c_n, 0)$ is a nontrivial solution of $c_1 \mathbf{v}_1 + \cdots + c_n \mathbf{v}_n + c_{n+1} \mathbf{v}_{n+1} = 0$. Thus $\mathbf{v}_1, \dots, \mathbf{v}_n, \mathbf{v}_{n+1}$ are linearly dependent.
29. Suppose $\mathbf{v}_1, \dots, \mathbf{v}_k$ are linearly dependent. Then there exists a nontrivial solution (c_1, \dots, c_k) of $c_1 \mathbf{v}_1 + \cdots + c_k \mathbf{v}_k = 0$. Then $(c_1, \dots, c_k, 0, \dots, 0)$ is a nontrivial solution of $c_1 \mathbf{v}_1 + \cdots + c_k \mathbf{v}_k + \cdots + c_n \mathbf{v}_n = 0$. But this implies $\mathbf{v}_1, \dots, \mathbf{v}_n$ are linearly dependent and this is a contradiction. Thus $\mathbf{v}_1, \dots, \mathbf{v}_k$ are linearly independent.
30. Suppose \mathbf{v}_1 and \mathbf{v}_2 are linearly dependent. Then $\mathbf{v}_2 = \alpha \mathbf{v}_1$ for some $\alpha \neq 0$. Then $\mathbf{v}_1 \cdot \mathbf{v}_2 = \alpha |\mathbf{v}_1|^2 \neq 0$, since \mathbf{v}_1 is a nonzero vector. This contradicts \mathbf{v}_1 and \mathbf{v}_2 being orthogonal. Thus \mathbf{v}_1 and \mathbf{v}_2 are linearly independent.
31. If $c_1 \mathbf{v}_1 + c_2 \mathbf{v}_2 + c_3 \mathbf{v}_3 = 0$ then $0 = 0 \cdot \mathbf{v}_1 = c_1 |\mathbf{v}_1|^2 + c_2 \mathbf{v}_2 \cdot \mathbf{v}_1 + c_3 \mathbf{v}_3 \cdot \mathbf{v}_1 = c_1 |\mathbf{v}_1|^2$. So $c_1 = 0$ as $\mathbf{v}_1 \neq 0$. Then $0 = c_2 |\mathbf{v}_2|^2 + c_3 \mathbf{v}_3 \cdot \mathbf{v}_2 = c_2 |\mathbf{v}_2|^2$, so $c_2 = 0$. And finally, $0 = c_3 \mathbf{v}_3 \cdot \mathbf{v}_3$, or $c_3 = 0$. Thus $\mathbf{v}_1, \mathbf{v}_2$ and \mathbf{v}_3 are linearly independent, as only $c_1 = c_2 = c_3 = 0$ solves.
32. Suppose $\mathbf{v}_1, \mathbf{v}_2, \dots, \mathbf{v}_n$ are linearly independent. Then $a_1 \mathbf{v}_1 + a_2 \mathbf{v}_2 + \cdots + a_n \mathbf{v}_n = 0$ has only the trivial solution. So no arbitrary variables in solving. Thus every column in row echelon form has a pivot. Since n rows and n columns, every row has a pivot, i.e. no zero rows in echelon form. Conversely, if the row echelon form of A does not contain a row of zeros, this implies that the only solution to $A\mathbf{x} = 0$ is $\mathbf{x} = 0$, since n non-zero rows implies n pivots. Thus $\mathbf{v}_1, \mathbf{v}_2, \dots, \mathbf{v}_n$ are linearly independent.

$$33. \begin{pmatrix} x_1 \\ x_2 \\ x_3 \end{pmatrix} = x_2 \begin{pmatrix} -1 \\ 1 \\ 0 \end{pmatrix} + x_3 \begin{pmatrix} -1 \\ 0 \\ 1 \end{pmatrix}, \text{ since } x_1 = -x_2 - x_3.$$

$$34. \left(\begin{array}{cccc|c} 1 & -1 & 7 & -1 & 0 \\ 2 & 3 & -8 & 1 & 0 \end{array} \right) \rightarrow \left(\begin{array}{cccc|c} 1 & -1 & 7 & -1 & 0 \\ 0 & 5 & -22 & 3 & 0 \end{array} \right) \rightarrow \left(\begin{array}{cccc|c} 1 & 0 & 13/5 & -2/5 & 0 \\ 0 & 1 & -22/5 & 3/5 & 0 \end{array} \right) \text{ So solving in terms of } x_3, x_4$$

yields $\begin{pmatrix} x_1 \\ x_2 \\ x_3 \\ x_4 \end{pmatrix} = x_3 \begin{pmatrix} -13/5 \\ 22/5 \\ 1 \\ 0 \end{pmatrix} + x_4 \begin{pmatrix} 2/5 \\ -3/5 \\ 0 \\ 1 \end{pmatrix}.$

$$35. \left(\begin{array}{ccc|c} 1 & 2 & -1 & 0 \\ 2 & 5 & 4 & 0 \end{array} \right) \rightarrow \left(\begin{array}{ccc|c} 1 & 2 & -1 & 0 \\ 0 & 1 & 6 & 0 \end{array} \right) \rightarrow \left(\begin{array}{ccc|c} 1 & 0 & -13 & 0 \\ 0 & 1 & 6 & 0 \end{array} \right); \begin{pmatrix} x_1 \\ x_2 \\ x_3 \end{pmatrix} = x_3 \begin{pmatrix} 13 \\ -6 \\ 1 \end{pmatrix}$$

$$36. \left(\begin{array}{cccc|c} 1 & 1 & 1 & -1 & 0 \\ -2 & 3 & 1 & 4 & -6 \end{array} \right) \rightarrow \left(\begin{array}{cccc|c} 1 & 1 & 1 & -1 & 0 \\ 0 & 5 & 3 & 2 & -8 \end{array} \right) \rightarrow \left(\begin{array}{cccc|c} 1 & 0 & 2/5 & -7/5 & 3/5 \\ 0 & 1 & 3/5 & 2/5 & -8/5 \end{array} \right) \text{ So } x_3, x_4, x_5 \text{ arbitrary}$$

and $\begin{pmatrix} x_1 \\ x_2 \\ x_3 \\ x_4 \\ x_5 \end{pmatrix} = x_3 \begin{pmatrix} -2/5 \\ -3/5 \\ 1 \\ 0 \\ 0 \end{pmatrix} + x_4 \begin{pmatrix} 7/5 \\ -2/5 \\ 0 \\ 1 \\ 0 \end{pmatrix} + x_5 \begin{pmatrix} -3/5 \\ 8/5 \\ 0 \\ 0 \\ 1 \end{pmatrix}$

$$37. \begin{pmatrix} x_1 \\ x_2 \\ x_3 \\ x_4 \end{pmatrix} = x_2 \begin{pmatrix} -2 \\ 1 \\ 0 \\ 0 \end{pmatrix} + x_3 \begin{pmatrix} 3 \\ 0 \\ 1 \\ 0 \end{pmatrix} + x_4 \begin{pmatrix} -5 \\ 0 \\ 0 \\ 1 \end{pmatrix}, \text{ as } x_1 = -2x_2 + 3x_3 - 5x_4.$$

38. (a) See 39(a) below, it does not depend on specific \mathbf{u} .
 (b) From $\mathbf{u} \cdot \mathbf{x} = x_1 + 2x_2 + 3x_3 = 0$, get $\mathbf{x} = (-2, 1, 0)$ and $\mathbf{y} = (-3, 0, 1)$.
 (c) $\mathbf{w} = \begin{vmatrix} \mathbf{i} & \mathbf{j} & \mathbf{k} \\ -2 & 1 & 0 \\ -3 & 0 & 1 \end{vmatrix} = \mathbf{i} + 2\mathbf{j} + 3\mathbf{k}$.
 (d) Note that $\mathbf{w} = \mathbf{u}$. (Other choices for \mathbf{x}, \mathbf{y} would yield other \mathbf{w} .)
 (e) See 39(e) below.
39. (a) Suppose $\mathbf{x}, \mathbf{y} \in H$. Then $\mathbf{u} \cdot (\mathbf{x} + \mathbf{y}) = \mathbf{u} \cdot \mathbf{x} + \mathbf{u} \cdot \mathbf{y} = 0 + 0 = 0$. Then $\mathbf{x} + \mathbf{y} \in H$. Suppose $\alpha \in \mathbb{R}$. Then $\mathbf{u} \cdot (\alpha\mathbf{x}) = \alpha(\mathbf{u} \cdot \mathbf{x}) = \alpha(0) = 0$. Then $\alpha\mathbf{x} \in H$. Therefore, H is a subspace of \mathbb{R}^3 .
 (b) Suppose that $\mathbf{u} = (a, b, c)$; Then since $\mathbf{u} \neq \mathbf{0}$, at least one of a, b , or c is non-zero. Suppose that a is not zero. Then $\mathbf{x} = (-b, a, 0)$ and $\mathbf{y} = (-c, 0, a)$ are linearly independent vectors in H . A similar process works if $b \neq 0$ or $c \neq 0$.
 (c) $\mathbf{w} = \begin{vmatrix} \mathbf{i} & \mathbf{j} & \mathbf{k} \\ -b & a & 0 \\ -c & 0 & a \end{vmatrix} = a^2\mathbf{i} + ab\mathbf{j} + ack$. (Key point: $\mathbf{w} = \mathbf{x} \times \mathbf{y}$ is orthogonal to \mathbf{x} and \mathbf{y} .)
 (d) Note that $\mathbf{w} = a\mathbf{u}$.
 (e) H consists of all the vectors which are perpendicular to \mathbf{u} . Then H will be the plane for which \mathbf{u} is a normal vector. $\mathbf{w} = \mathbf{x} \times \mathbf{y}$ is also a vector which is perpendicular to the plane. Since \mathbf{u} and \mathbf{w} are both perpendicular to the same plane in \mathbb{R}^3 , they must be linearly dependent.
40. Consider $f_1(x) = a_1x^2 + b_1x + c_1$, $f_2(x) = a_2x^2 + b_2x + c_2$, $f_3(x) = a_3x^2 + b_3x + c_3$ and $f_4(x) = a_4x^2 + b_4x + c_4$ in P_2 . If we wish to solve for (k_1, k_2, k_3, k_4) in the equation $k_1(f_1(x)) + k_2(f_2(x)) + k_3(f_3(x)) + k_4(f_4(x)) = 0$, we must equate coefficients of $1, x, x^2$ to 0 and we get three homogeneous equations with four unknowns. In this case, there will always be a nontrivial solution for (k_1, k_2, k_3, k_4) . Thus any four polynomials in P_2 are linearly dependent.
41. Suppose $f_1(x)$ and $f_2(x)$ span P_2 . Then for any $f(x) = ax^2 + bx + c$ in P_2 , we would need $k_1(f_1(x)) + k_2(f_2(x)) = f(x)$, for some $k_1, k_2 \in \mathbb{R}$. Therefore, if $f_1(x) = a_1x^2 + b_1x + c_1$ and $f_2(x) = a_2x^2 + b_2x + c_2$, we would have, equating coefficients of $1, x, x^2$:

$$\begin{aligned} k_1a_1 + k_2a_2 &= a \\ k_1b_1 + k_2b_2 &= b \\ k_1c_1 + k_2c_2 &= c. \end{aligned}$$

With three equations and two unknowns it is always possible to choose a, b and c so that no solution exists. Thus f_1 and f_2 cannot span P_2 . (Specifically there will be a row of zeros in echelon form whose third column will say 0 is a non-trivial linear combination of a, b, c . Not all a, b, c will satisfy this condition.)

42. Suppose $f_1, f_2, \dots, f_n, f_{n+1}, f_{n+2}$ are in P_n . (Note: we are using the same notation as in 40.) If we consider $k_1f_1 + k_2f_2 + \dots + k_{n+2}f_{n+2} = 0$, then, as in #40, if we equate coefficients we get $n + 1$ equations in $n + 2$ unknowns. Then there will always be a nontrivial solution for $(k_1, k_2, \dots, k_{n+2})$. Thus any $n + 2$ polynomials in P_n are linearly dependent.
43. Note that if we are given any set of linearly dependent vectors, then if any vectors are added to the set we still have a set of linearly dependent vectors. Thus if any set has a subset which is linearly dependent, then the original set is linearly dependent. Then any linearly independent set cannot have a subset which is linearly dependent. Thus, any subset of a linearly independent set is linearly independent.
44. Suppose $A_1, A_2, A_3, A_4, A_5, A_6$ and A_7 are in M_{32} . Consider solving $a_1A_1 + a_2A_2 + a_3A_3 + a_4A_4 + a_5A_5 + a_6A_6 + a_7A_7 = \mathbf{0}$ for $(a_1, a_2, a_3, a_4, a_5, a_6, a_7)$. This generates six homogeneous equations with seven unknowns. Then, regardless of the given matrices, there will always be a nontrivial solution. Thus any seven matrices of M_{32} are linearly dependent.

45. Suppose that A_1, \dots, A_{mn+1} are in M_{mn} . Consider solving $\sum a_i A_i = O$ for numbers $\{a_i\}$; this is mn homogeneous equations in $mn + 1$ unknowns. Therefore there will always be a nontrivial solution. Thus any $mn + 1$ matrices of M_{mn} are linearly dependent.
46. Note that $S_1 \cap S_2$ is a subset of both S_1 and S_2 , each of which is a linearly independent set. Then by problem 43, $S_1 \cap S_2$ is linearly independent. (Note that the empty set of vectors is linearly independent, so you need not require $S_1 \cap S_2$ to be non-empty.)
47. Clearly this is true for $n = 1$. Assume that $1, x, x^2, \dots, x^{n-1}$ are linearly independent. Then consider $a_0 + a_1 x + \dots + a_{n-1} x^{n-1} + a_n x^n = 0$. Note that a_n must be zero by properties of polynomial addition (i.e., only add like terms) or take n derivatives to get $n! a_n = 0$. Then by our assumption we have $a_0 = 0, a_1 = 0, \dots, a_{n-1} = 0$. Thus $1, x, x^2, \dots, x^{n-1}, x^n$ are linearly independent.
48. Consider $a_1 \mathbf{v}_1 + a_2(\mathbf{v}_1 + \mathbf{v}_2) + \dots + a_n(\mathbf{v}_1 + \mathbf{v}_2 + \dots + \mathbf{v}_n) = 0$. Then we have $(a_1 + a_2 + \dots + a_n)\mathbf{v}_1 + (a_2 + \dots + a_n)\mathbf{v}_2 + \dots + a_n \mathbf{v}_n = 0$. Since $\{\mathbf{v}_1, \mathbf{v}_2, \dots, \mathbf{v}_n\}$ is a linearly independent set, we have

$$\begin{aligned} a_1 + a_2 + \dots + a_n &= 0 \\ a_2 + \dots + a_n &= 0 \\ &\vdots \\ a_n &= 0 \end{aligned}$$

By backward substitution, we have $a_n = 0, a_{n-1} = 0, \dots, a_2 = 0, a_1 = 0$. Thus $\mathbf{v}_1, \mathbf{v}_1 + \mathbf{v}_2, \dots, \mathbf{v}_1 + \mathbf{v}_2 + \dots + \mathbf{v}_n$ are linearly independent.

49. Since $\mathbf{v}_1, \mathbf{v}_2, \dots, \mathbf{v}_n$ are linearly dependent, there exist b_1, b_2, \dots, b_n , where $b_1 \mathbf{v}_1 + b_2 \mathbf{v}_2 + \dots + b_n \mathbf{v}_n = \mathbf{0}$ with at least two of the b_i 's nonzero since $\mathbf{v}_1, \mathbf{v}_2, \dots, \mathbf{v}_n$ are nonzero. Choose k to be the largest i such that $b_i \neq 0$. Note then that $1 < k \leq n$ and, if we let $a_i = -b_i/b_k$, then $\mathbf{v}_k = a_1 \mathbf{v}_1 + a_2 \mathbf{v}_2 + \dots + a_{k-1} \mathbf{v}_{k-1}$.
50. If all the vectors are the zero vector then we are done. If not, then without loss of generality, assume \mathbf{v}_1 is a nonzero vector. Since $\{\mathbf{v}_1, \mathbf{v}_2\}$ is linearly dependent, $\mathbf{v}_2 = a_1 \mathbf{v}_1$ for some a_1 . Since $\{\mathbf{v}_1, \mathbf{v}_3\}$ is linearly dependent, $\mathbf{v}_3 = a_2 \mathbf{v}_1$ for some a_2 . Continuing on with this process, we find that each vector is a multiple of \mathbf{v}_1 .

51. $f(x) = cg(x)$ for some $c \in \mathbb{R}$. Then $f'(x) = cg'(x)$. Then $W(f, g)(x) = \begin{vmatrix} cg(x) & g(x) \\ cg'(x) & g'(x) \end{vmatrix} = 0$.

$$52. W(f_1, f_2, \dots, f_n) = \begin{vmatrix} f_1(x) & f_2(x) & \dots & f_n(x) \\ f_1'(x) & f_2'(x) & \dots & f_n'(x) \\ \vdots & \vdots & \vdots & \vdots \\ f_1^{(n-1)}(x) & f_2^{(n-1)}(x) & \dots & f_n^{(n-1)}(x) \end{vmatrix}$$

53. Consider $a_1(\mathbf{u} + \mathbf{v}) + a_2(\mathbf{u} + \mathbf{v}) + a_3(\mathbf{v} + \mathbf{w}) = 0$

$$(a_1 + a_2)\mathbf{u} + (a_1 + a_3)\mathbf{v} + (a_2 + a_3)\mathbf{w} = 0$$

Since \mathbf{u}, \mathbf{v} and \mathbf{w} are linearly independent, we have

$$\left. \begin{aligned} a_1 + a_2 &= 0 \\ a_1 + a_3 &= 0 \\ a_2 + a_3 &= 0 \end{aligned} \right\} \Rightarrow a_1 = 0, a_2 = 0, a_3 = 0, \text{ by elimination.}$$

Thus $\mathbf{u} + \mathbf{v}, \mathbf{u} + \mathbf{w}$ and $\mathbf{v} + \mathbf{w}$ are linearly independent.

54. We need $\begin{vmatrix} 1-c & 1+c \\ 1+c & 1-c \end{vmatrix} = (1-c)^2 - (1+c)^2 = -4c \neq 0$. Thus the vectors are linearly independent if $c \neq 0$.

55.

$$\begin{aligned} \begin{vmatrix} 1 & 1 & 1 \\ a & b & c \\ a^2 & b^2 & c^2 \end{vmatrix} &= \begin{vmatrix} 1 & 1 & 1 \\ 0 & b-a & c-a \\ 0 & b^2-ab & c^2-ca \end{vmatrix} = \begin{vmatrix} b-a & c-a \\ b(b-a) & c(c-a) \end{vmatrix} \\ &= (b-a)(c-a) \begin{vmatrix} 1 & 1 \\ b & c \end{vmatrix} \\ &= (b-a)(c-a)(c-b) \\ &\neq 0, \text{ if } a \neq b, a \neq c \text{ and } b \neq c. \end{aligned}$$

Thus the vectors are linearly independent.

56. Suppose $\{\mathbf{v}_1, \mathbf{v}_2, \dots, \mathbf{v}_n, \mathbf{v}\}$ is a linearly dependent set. Since $\{\mathbf{v}_1, \mathbf{v}_2, \dots, \mathbf{v}_n\}$ is a linearly independent set, then $\mathbf{v} = a_1\mathbf{v}_1 + \dots + a_n\mathbf{v}_n$ for some $a_1, \dots, a_n \in \mathbb{R}$ by the solution to Problem 49. Then $\mathbf{v} \in \text{span}\{\mathbf{v}_1, \mathbf{v}_2, \dots, \mathbf{v}_n\}$, which is a contradiction. Thus $\{\mathbf{v}_1, \mathbf{v}_2, \dots, \mathbf{v}_n, \mathbf{v}\}$ is a linearly independent set.

57. $\begin{pmatrix} 2 \\ 1 \\ 2 \end{pmatrix}, \begin{pmatrix} -1 \\ 3 \\ 4 \end{pmatrix}, \begin{pmatrix} 1 \\ 1 \\ 1 \end{pmatrix}$. (Eliminate in $\begin{pmatrix} 2 & -1 & a \\ 1 & 3 & b \\ 2 & 4 & c \end{pmatrix}$, then choose any a, b, c making bottom row not all zeros.)

58. $1 - x^2, 1 + x^2, x$. (Any quadratic with non-zero x term will work.)

59. (a) Note that since the vectors \mathbf{u}, \mathbf{v} and \mathbf{w} are coplanar, the points $(u_1, u_2, u_3), (v_1, v_2, v_3), (w_1, w_2, w_3)$ and $(0, 0, 0)$ are all contained in some plane. Let $ax + by + cz = 0$ be the equation of such a plane with $\mathbf{n} = (a, b, c)$ a normal to the plane. Note that a, b and c are not all zero. Then we have

$$\begin{aligned} au_1 + bu_2 + cu_3 &= 0 \\ av_1 + bv_2 + cv_3 &= 0 \\ aw_1 + bw_2 + cw_3 &= 0. \end{aligned}$$

(b) Let $A = \begin{pmatrix} u_1 & u_2 & u_3 \\ v_1 & v_2 & v_3 \\ w_1 & w_2 & w_3 \end{pmatrix}$; $\det A \neq 0 \Leftrightarrow \mathbf{0}$ is the only solution to $A\mathbf{x} = \mathbf{0}$. But, $\mathbf{x} = \begin{pmatrix} a \\ b \\ c \end{pmatrix} \neq \mathbf{0}$ is a solution to $A\mathbf{x} = \mathbf{0}$. Thus $\det A = 0$.

(c) Note that $\det A^t = \det A = 0$. Thus, $A^t\mathbf{x} = \mathbf{0}$ has a nontrivial solution. Thus, by Theorem 3, \mathbf{u}, \mathbf{v} and \mathbf{w} are linearly dependent.

MATLAB 4.5

1. In each case, A the augmented matrix is entered, if `rref(A)` has a column on the left without a pivot in it, then the vectors are dependent, otherwise they are independent.

```

>> A = [ 1 -1 0; 2 -3 0];      % Problem 1.
>> rref(A)
ans =
     1     0     0
     0     1     0

>> A = [ 2 4 0; -1 -2 0; 4 7 0]; % Problem 2.
>> rref(A)
ans =
     1     0     0
     0     1     0
     0     0     0

>> A = [ 2 4 0; -1 -2 0; 4 8 0]; % Problem 3.
>> rref(A)
ans =
     1     2     0
     0     0     0
     0     0     0

>> A = [ -2 4 0; 3 7 0];      % Problem 4.
>> rref(A)
ans =
     1     0     0
     0     1     0

>> A = [ -3 1 4 0; 2 10 -5 0]; % Problem 5.
>> rref(A)
ans =
    1.0000         0   -1.4062         0
         0    1.0000   -0.2188         0

>> A = [ 1 0 1 0; 0 1 1 0; 1 1 0 0]; % Problem 6.
>> rref(A)
ans =
     1     0     0     0
     0     1     0     0
     0     0     1     0

>> A = [ 1 0 0 0; 0 1 0 0; 0 0 1 0]; % Problem 7.
>> rref(A)
ans =
     1     0     0     0
     0     1     0     0
     0     0     1     0

>> A = [ -3 7 1 0; 4 -1 2 0; 2 3 8 0]; % Problem 8.
>> rref(A)
ans =
     1     0     0     0
     0     1     0     0
     0     0     1     0

```



```

>> A = [ -3 7 1 0; 4 -1 1 0; 2 3 8 0]; % Problem 9.
>> rref(A)
ans =
    1    0    0    0
    0    1    0    0
    0    0    1    0

>> A = [ 1 3 0 5 0; -2 0 4 0 0; 1 2 -1 3 0; 1 -2 -1 -1 0]; % Problem 10.
>> rref(A)
ans =
    1    0    0    2    0
    0    1    0    1    0
    0    0    1    1    0
    0    0    0    0    0

>> A = [ 1 3 0 5 0; -2 0 4 0 0; 1 2 -1 3 0; 1 -2 1 -1 0]; % Problem 11.
>> rref(A)
ans =
    1    0    0    0    0
    0    1    0    0    0
    0    0    1    0    0
    0    0    0    1    0

>> A = [ 1 4 -2 7 0; -1 0 3 1 0; 2 0 5 2 0]; % Problem 12.
>> rref(A)
ans =
    1.0000    0    0    0.0909    0
    0    1.0000    0    1.9091    0
    0    0    1.0000    0.3636    0

```

The sets which are linearly independent are 1, 2, 4, 6, 7, 8, 9, and 11. The sets which are linearly dependent are 3, 5, 10, and 12.

2. In the text, it is stated “Three vectors in \mathbb{R}^3 are linearly dependent if and only if they are coplanar.”
- (a) Since they are linearly independent, they must not be coplanar.
 - (b) We need only show they are linearly dependent. To do this, we reduce the augmented matrix formed from the homogeneous equation.
 - (i)

```

>> A = [1 2 3 0; 2 1 3 0; 1 3 4 0];
>> rref(A)
ans =
    1    0    1    0
    0    1    1    0
    0    0    0    0

```

(ii)

```

>> A = [1 -1 2 0 ; 2 0 6 0 ; 1 1 4 0];
>> rref(A)
ans =
    1    0    3    0
    0    1    1    0
    0    0    0    0

```

In both cases, there was a column on the left without a pivot, so the sets were dependent.

3.

```

>> m = 4; n = 3; % Choose values for m and n.
>> A = 2*rand(n,m) -1
A =
   -0.5621    0.3586    0.0388   -0.8931
   -0.9059    0.8694    0.6619    0.0594
    0.3577   -0.2330   -0.9309    0.3423

>> rref(A)
ans =
   1.0000         0         0    4.5903
         0    1.0000         0    4.6803
         0         0    1.0000    0.2248

```

The fourth column does not have a pivot, so the columns are linearly dependent. Conjecture: If a matrix has more columns than rows, the columns will always be linearly dependent. Proof: This follows directly from Theorem 2.

4. Refer to the answer to problem 2 in Section 1.8. The matrices in part (i), (iv), and (v) were invertible, and since they reduced to the identity matrix, their columns are linearly independent. The matrices in part (ii), (iii), and (vi) were not invertible, and their columns were dependent. We now check for linear independence of the rows, by reducing A^t .

```

>> A = (1/13)* [2 7 5; 0 9 8; 7 4 0]; % Matrix for (i)
>> rref(A')
ans =
     1     0     0
     0     1     0
     0     0     1

>> A = [2 -4 5; 0 0 8; 7 -14 0]; % Matrix for (ii)
>> rref(A')
ans =
   1.0000         0    3.5000
         0    1.0000   -2.1875
         0         0         0

>> A = [1 4 -2 1; 5 1 9 7; 7 4 10 4; 0 7 -7 7]; % Matrix for (iii)
>> rref(A')
ans =
   1.0000         0         0    2.8000
         0    1.0000         0    1.4000
         0         0    1.0000   -1.4000
         0         0         0         0

>> A = [1 4 6 1; 5 1 9 7; 7 4 8 4; 0 7 5 7]; % Matrix for (iv)
>> rref(A')
ans =
     1     0     0     0
     0     1     0     0
     0     0     1     0
     0     0     0     1

```

```
>> A = (-1/56) * [1 2 3 4 5      % Matrix for (v)
                  0 -1 2 -1 2
                  1 0 0 2 -1
                  1 1 -1 1 1
                  0 0 0 0 4];
```

```
>> rref(A')
ans =
    1    0    0    0    0
    0    1    0    0    0
    0    0    1    0    0
    0    0    0    1    0
    0    0    0    0    1
```

```
>> A = [ 1 2 -1 7 5      % Matrix for (vi)
        0 -1 2 -3 2
        1 0 3 1 -1
        1 1 1 4 1
        0 0 0 0 4];
```

```
>> rref(A')
ans =
    1.0000         0         0    0.4000    0.4000
         0    1.0000         0   -0.2000    0.8000
         0         0    1.0000    0.6000   -0.4000
         0         0         0         0         0
         0         0         0         0         0
```

In each case, the invertible matrices had linearly independent rows, and the singular matrices had linearly dependent rows. This is proved in the summing up theorem.

5. (a) If the entries in \mathbf{z} are $\{z_1, z_2, \dots, z_m\}$, and the columns of A are $\{\mathbf{v}_1, \mathbf{v}_2, \dots, \mathbf{v}_m\}$, then $\mathbf{w} = A\mathbf{z} = z_1\mathbf{v}_1 + z_2\mathbf{v}_2 + \dots + z_m\mathbf{v}_m$. Since the z_i 's are scalars, this shows that \mathbf{w} is a linear combination of the \mathbf{v}_i 's.
 (b) (i):

```
>> A = [ 8 1 10; 7 -7 -6; -8 -1 -1]; % The matrix of vectors.
>> z = round(10*(2*rand(3,1)-1)) % Generate a random vector z.
z =
    -6
    -9
     4

>> w = A*z      % w is a linear combination of columns of A
w =
   -17
     -3
     53

>> rref([ A w ] )      % Test if this set is linearly dependent.
ans =
     1     0     0    -6
     0     1     0    -9
     0     0     1     4
```

Since there is a column without a pivot in the row echelon form, the set $\{\mathbf{v}_1, \mathbf{v}_2, \mathbf{v}_3, \mathbf{w}\}$ is linearly dependent. This can be repeated for several other random vectors \mathbf{z} .

(ii)

```

>> A = [1 -1 2; 0 2 -1; 1 3 0; 1 1 4]; % The matrix of vectors.
>> z = round(10*(2*rand(3,1)-1)) % Generate a random vector z.
z =
     4
     9
    -2

>> w = A*z % w is a linear combination of
w =
    -9
    20
    31
     5

>> rref([ A w ] ) % Test if this set is linearly dependent.
ans =
     1     0     0     4
     0     1     0     9
     0     0     1    -2
     0     0     0     0

```

Since there is a column without a pivot in the row echelon form, the set $\{v_1, v_2, v_3, w\}$ is linearly dependent.

(iii)

```

>> A = [ 4 10 6 3; 3 2 2 2; 2 8 8 1; 0 1 2 2; 2 4 10 6]; % The matrix.
>> z = round(10*(2*rand(4,1)-1)) % Generate a random vector z.
z =
     0
     7
    -9
    -9

>> w = A*z % w is a linear combination of
w =
    -11
    -22
    -25
    -29
   -116

>> rref([ A w ] ) % Test if this set is linearly dependent.
ans =
     1     0     0     0     0
     0     1     0     0     7
     0     0     1     0    -9
     0     0     0     1    -9
     0     0     0     0     0

```

Since there is a column without a pivot in the row echelon form, the set $\{v_1, v_2, v_3, v_4, w\}$ is linearly dependent.

(c) If w is in the span of $\{v_1, v_2, \dots, v_m\}$, then $\{v_1, v_2, \dots, v_m, w\}$ is a linearly dependent set.

6. (a) In each case, the matrix A is made with the vectors as its columns. Since the system with augmented matrix $S = [A \ 0]$ has a nonzero solution, the vectors are linearly dependent.

```
>> S = [ 1 -1 3 0; 1 1 0 0]; % For problem 3i.
>> rref(S)
ans =
    1.0000         0    1.5000         0
         0    1.0000   -1.5000         0

>> S = [ 1 -2 5 0; 2 3 4 0]; % For problem 3ii.
>> rref(S)
ans =
    1.0000         0    3.2857         0
         0    1.0000   -0.8571         0

>> % For problem 7a.
>> S = [ 3 -2 7 14 1 0 ; -7 0 2 -5 -5 0 ; 4 -7 9 27 0 0 ; -2 2 1 -5 -1 0 ];
>> rref(S)
ans =
     1     0     0     1     0     0
     0     1     0    -2     0     0
     0     0     1     1     0     0
     0     0     0     0     1     0

>> S = [ 10 0 -10 -6 32 0; 8 2 -4 -7 32 0; -5 7 19 1 -5 0]; % For problem 7e.
>> rref(S)
ans =
     1     0    -1     0     2     0
     0     1     2     0     1     0
     0     0     0     1    -2     0
```

- (b) The equation $\mathbf{w} = c_1\mathbf{v}_1 + c_2\mathbf{v}_2 + \cdots + c_k\mathbf{v}_k$ is equivalent to the system $[A \ \mathbf{w}]$ where A is the matrix whose columns are the vectors \mathbf{v}_i . If this system reduces to $[R \ \mathbf{u}]$ in row echelon form, then $[A \ 0]$ reduces to $[R \ 0]$. If there are an infinite number of solutions to $[A \ \mathbf{w}]$, then R will have a column without a pivot in it. In this case, the system $[A \ 0]$ will also have an infinite number of solutions. Since $[A \ 0]$ has a nontrivial solution, the columns of A are not linearly independent.

7. (a)

```
>> m = 3; n =4; % Choose values for m and n.
>> A = 2*rand(n,m)-1
A =
    0.0594   -0.8663    0.8609
    0.3423   -0.1650    0.6923
   -0.9846    0.3735    0.0539
   -0.2332    0.1780   -0.8161

>> rref(A) % Check for linear dependence.
ans =
     1     0     0
     0     1     0
     0     0     1
     0     0     0
```

Since every column has a pivot, the columns of A are linearly independent. This will be true for almost all randomly chosen matrices.

```
>> B = A;
>> B(:,3) = 3*B(:,1) - 2*B(:,2)
B =
    0.0594   -0.8663    1.9108
    0.3423   -0.1650    1.3570
   -0.9846    0.3735   -3.7009
   -0.2332    0.1780   -1.0554

>> rref(B)
ans =
     1     0     3
     0     1    -2
     0     0     0
     0     0     0
```

The third column does not have a pivot, so the columns of B are dependent. This corresponds to choosing the third column of B to be a linear combination of the first and second.

- (b) The above can be repeated several times.
 (c) If a column of A is a linear combination of other columns of A , then the columns are linearly dependent.
 (d) See solution to problem 5 in MATLAB 1.7
 (e) If the columns of A are linearly dependent, then one column can be written as a linear combination of the others. This is the converse of the statement in (c).
 (f) Proof: Let the columns of A be the vectors $\mathbf{v}_1, \mathbf{v}_2, \dots, \mathbf{v}_n$. The columns of A are linearly dependent if and only if there is a nontrivial solution of $c_1\mathbf{v}_1 + c_2\mathbf{v}_2 + \dots + c_n\mathbf{v}_n = 0$. Pick one of the coefficients that is nonzero, for example, c_k . This equation can be rewritten as

$$-c_k\mathbf{v}_k = c_1\mathbf{v}_1 + \dots + c_{k-1}\mathbf{v}_{k-1} + c_{k+1}\mathbf{v}_{k+1} + \dots + c_n\mathbf{v}_n.$$

If we divide this by $-c_k$, then we get

$$\mathbf{v}_k = -(c_1/c_k)\mathbf{v}_1 - \dots - (c_{k-1}/c_k)\mathbf{v}_{k-1} - (c_{k+1}/c_k)\mathbf{v}_{k+1} - \dots - (c_n/c_k)\mathbf{v}_n,$$

which means that \mathbf{v}_k is a linear combination of the other columns. Conversely, if \mathbf{v}_k is a linear combination of the other columns, then

$$\mathbf{v}_k = c_1\mathbf{v}_1 + \dots + c_{k-1}\mathbf{v}_{k-1} + c_{k+1}\mathbf{v}_{k+1} + \dots + c_n\mathbf{v}_n.$$

Bring \mathbf{v}_k to the other side, and letting $c_k = -1$, we get a nontrivial solution of

$$0 = c_1\mathbf{v}_1 + \dots + c_n\mathbf{v}_n,$$

which means that the columns are linearly dependent.

8. (a)
 (i)

```
>> A = [1 0 2; 2 3 1; -1 1 -3];
>> rref(A)
ans =
     1     0     2
     0     1    -1
     0     0     0
```

The third column is 2 times the first plus -1 times the second. To verify this:

```
>> 2*A(:,1) -1* A(:,2)      % This should be the third column.
ans =
     2
     1
    -3
```

(ii)

```
>> A = [10 0 -10 -6 32; 8 2 -4 -7 32; -5 7 19 1 -5];
>> rref(A)
ans =
     1     0     -1     0     2
     0     1     2     0     1
     0     0     0     1    -2

>> -1*A(:,1) + 2*A(:,2)      % This should be the third column.
ans =
    -10
     -4
     19

>> 2*A(:,1) + 1*A(:,2) -2*A(:,4) % This should be the fifth column.
ans =
     32
     32
     -5
```

(iii)

```
>> A = [ 7 6 11 3 5; 8 1 -5 -20 9; 7 6 11 3 8; 8 2 -2 -16 6; 7 3 2 -9 7];
>> rref(A)
ans =
     1     0     -1     -3     0
     0     1     3     4     0
     0     0     0     0     1
     0     0     0     0     0
     0     0     0     0     0

>> -1*A(:,1) + 3*A(:,2)      % This should be the third column.
ans =
     11
     -5
     11
     -2
     2

>> -3*A(:,1) + 4*A(:,2)      % This should be the fourth column.
ans =
     3
    -20
     3
    -16
     -9
```

(iv)

```

>> A = [ 1 3 1 1 3; -2 4 0 1 -1; 0 -2 -3 1 9; 1 1 2 1 5];
>> R = rref(A)

R =
    1.0000         0         0         0    1.0526
         0    1.0000         0         0   -1.1579
         0         0    1.0000         0   -0.3158
         0         0         0    1.0000    5.7368

>> c = R(:,5);           % The fifth column of R gives the coef.
>>                               % This should be the fifth column of A:
>> c(1)*A(:,1) + c(2)*A(:,2) + c(3)*A(:,3) + c(4)*A(:,4)
ans =
    3.0000
   -1.0000
    9.0000
    5.0000

```

(b) See answer to problem 49.

9. (a) In each case, the matrix of vectors is reduced to row echelon form. Since every column has a pivot, the set is independent. Since the bottom row is all zeros, it is possible to pick a w so that the system $[A \ w]$ does not have a solution, which means that w is not in the span of the columns of A .

(i)

```

>> A = [ -1; 2];
>> rref(A)
ans =
     1
     0

```

(ii)

```

>> A = [1 -1 2; 0 2 -1; 1 3 0; 1 1 4];
>> rref(A)
ans =
     1     0     0
     0     1     0
     0     0     1
     0     0     0

```

(iii)

```

>> A = [ 4 10 6 3; 3 2 2 2; 2 8 8 1; 0 1 2 2; 2 4 10 6];
>> rref(A)
ans =
     1     0     0     0
     0     1     0     0
     0     0     1     0
     0     0     0     1
     0     0     0     0

```

- (b) As above, the matrix of vectors is reduced to row echelon form. In each case, there is a column without a pivot, so the vectors are linearly dependent. However each row has a pivot; the system $[A \ w]$ will always have a solution, so the set spans all of \mathbb{R}^n .

(i)

```
>> A = [ 1 3 -1; 2 -1 0];
>> rref(A)
ans =
    1.0000         0   -0.1429
         0    1.0000   -0.2857
```

(ii)

```
>> A = [ 1 -1 2 1; 0 2 -1 1; 1 3 0 4];
>> rref(A)
ans =
    1.0000         0    1.5000         0
         0    1.0000   -0.5000         0
         0         0         0    1.0000
```

(iii)

```
>> A = [ 4 3 0 7 1 1; -1 2 1 2 1 1; 3 2 2 7 -1 1; 1 2 2 5 0 1];
>> rref(A)
ans =
    1.0000         0         0    1.0000         0   -0.1111
         0    1.0000         0    1.0000         0    0.5556
         0         0    1.0000    1.0000         0         0
         0         0         0         0    1.0000   -0.2222
```

(c) No it is not possible. In part (a), there was a pivot in every column, so the number of pivots was the same as the number of columns. However, there was a row without a pivot, so the number of rows was more than the number of pivots. This means that the number of rows is more than the number of columns. Similarly in part (b), the number of rows is less than the number of columns. This cannot happen for n vectors in \mathbb{R}^n , where the matrix A will have the same number of rows and columns.

(d) If $m < n$, a set of m vectors will never span \mathbb{R}^n . If $m = n$, the set is linearly independent if and only if it spans all of \mathbb{R}^n . If $m > n$, the set will never be linearly independent. The proof of all three of these come from reducing the matrix of these vectors to row echelon form. The set spans \mathbb{R}^n when every row has a pivot, and the set is linearly independent when every column has a pivot. If $m < n$, there can at most be m pivots, so at least one of the n rows will not have a pivot. If $m = n$, then every row has a pivot if and only if there are n pivots. This happens if and only if every column has a pivot. If $m > n$, there can be at most n pivots, so at least one of the m columns will not have a pivot.

10. (a) First, the matrix V whose columns are the vectors \mathbf{v}_i is entered. In each case, every column of the reduced row echelon form of V has a pivot.

(i)

```
>> Vi = [ 1 -1 2; 0 2 -1; 1 3 0; 1 1 4];
>> rref(Vi)
ans =
     1     0     0
     0     1     0
     0     0     1
     0     0     0
```

(ii)

```
>> Vii = [ 4 10 6 3; 3 2 2 2; 2 8 8 1; 0 1 2 2];
>> rref(Vii)
ans =
     1     0     0     0
     0     1     0     0
     0     0     1     0
     0     0     0     1
```

(iii)

```
>> Viii = [-1 -1; 0 0; 2 1; 3 5];
>> rref(Viii)
ans =
     1     0
     0     1
     0     0
     0     0
```

(iv)

```
>> Viv = round( 10*(2*rand(4)-1))
Viv =
    -6     9    -9   -10
    -9    -2    -9    -2
     4     0     1    -9
     4     7     3    -2

>> rref(Viv)
ans =
     1     0     0     0
     0     1     0     0
     0     0     1     0
     0     0     0     1
```

- (b) First, a random matrix is entered. To verify that it is invertible, we check that $\det(A)$ is nonzero. Then the matrix B is created whose columns are Av_i . This is done using $B = AV$. Next the matrix B is reduced to see if the vectors are independent. In each case, the vectors $\{Av_1, Av_2, \dots, Av_k\}$ are linearly independent.

```
>> A = round( 10*(2*rand(4)-1))
A =
     4     1     4    -9
     2    -8     8     5
     9     3     5    -3
     7    -2    -5     3

>> det(A)                                % Check that A is invertible.
ans =
    -7290
```

(i)

```
>> B = A*Vi
B =
   -1    1  -29
   15   11   32
   11    9    3
    5  -23   28

>> rref(B)
ans =
    1    0    0
    0    1    0
    0    0    1
    0    0    0
```

(ii)

```
>> B = A*Vii
B =
   27   65   40    0
    0   73   70    8
   55  133   94   32
   12   29    4   18

>> rref(B)
ans =
    1    0    0    0
    0    1    0    0
    0    0    1    0
    0    0    0    1
```

(iii)

```
>> B = A*Viii
B =
  -23  -45
   29   31
   -8  -19
   -8    3

>> rref(B)
ans =
    1    0
    0    1
    0    0
    0    0
```

(iv)

```
>> B = A*Viv
B =
  -53  -29  -68  -60
  112   69   77  -86
  -73   54 -112 -135
  -32   88  -41  -27
```

```
>> rref(B)
ans =
     1     0     0     0
     0     1     0     0
     0     0     1     0
     0     0     0     1
```

(c) This is done in the same way that (b) was.

```
>> A(:,3) = 2*A(:,1) - A(:,2)
A =
     4     1     7    -9
     2    -8    12     5
     9     3    15    -3
     7    -2    16     3
```

```
>> det(A) % This should be zero, for A to be singular.
ans =
     0
```

(i)

```
>> B = A*Vi
B =
     2    10   -29
    19    23    32
    21    39     3
    26    40    28
```

```
>> rref(B)
ans =
     1     0     0
     0     1     0
     0     0     1
     0     0     0
```

(ii)

```
>> B = A*Vii
B =
    33    89    64     3
     8   105   102    12
    75   213   174    42
    54   197   172    39
```

```
>> rref(B)
ans =
  1.0000     0     0  1.3846
     0  1.0000     0 -1.8718
     0     0  1.0000  1.9359
     0     0     0     0
```

(iii)

```
>> B = A*Viii
B =
   -17   -42
    37    35
    12    -9
    34    24
```

```
>> rref(B)
ans =
     1     0
     0     1
     0     0
     0     0
```

(iv)

```
>> B = A*Viv
B =
    -41    -29    -65    -87
    128     69     81   -122
    -33     54   -102   -225
     52     88    -20   -216
```

```
>> rref(B)
ans =
  1.0000         0         0   -3.0229
         0  1.0000         0   0.0629
         0         0  1.0000   3.2171
         0         0         0         0
```

The vectors from parts (i) and (iii) were still linearly independent. However, the vectors in part (ii) and (iv) were no longer linearly independent.

(d) If the matrix A is invertible, and a set $\{v_1, v_2, \dots, v_k\}$ is linearly independent, then the set $\{Av_1, Av_2, \dots, Av_k\}$ is also linearly independent.

11. To solve this problem, each polynomial in P_n is represented by a vector in \mathbb{R}^{n+1} , as in problem 9 in MATLAB 4.4. Then the matrix of these vectors is reduced to row echelon form. Finally, if any column doesn't have a pivot, the corresponding vector is written in terms of the other vectors.

```
>>                                     % Problem 13.
>> p1 = [1; -1; 0];                   % The first polynomial 1 - 1x + 0x^2
>> p2 = [0; 1; 0];                     % The second poly. 0 + 1x + 0x^2
>> A = [p1 p2];
>> rref(A)

ans =
     1     0
     0     1
     0     0
```

Every column has a pivot, so these polynomials are linearly independent.

```
>>                                     % Problem 14.
>> A = [0 0 0                           % The constant terms of the polynomials.
        -1 -2 3                          % The x terms.
         0 1 5];                          % The x^2 terms.
>> rref(A)
ans =
     1     0   -13
     0     1     5
     0     0     0
```

These are linearly dependent, and the third column can be written in terms of the first two.

```
>> -13*A(:,1) + 5*A(:,2)
ans =
     0
     3
     5
```

In terms of the polynomials $(3x + 5x^2) = -13(-x) + 5(x^2 - 2x)$.

```
>>                                     % Problem 15.
>> A = [ 1 1 0                         % The constant terms.
        -1 1 0                         % The x terms.
         0 0 1];                       % The x^2 terms.
>> rref(A)
ans =
     1     0     0
     0     1     0
     0     0     1
```

These are linearly independent.

```
>>                                     % Problem 16.
>> A = [ 0 0 0                         % The Constant terms.
         1 -1 -1                       % The x terms.
         0 1 0                         % The x^2 terms.
         0 0 1];                       % The x^3 terms.
>> rref(A)
ans =
     1     0     0
     0     1     0
     0     0     1
     0     0     0
```

These are linearly independent.

```
>>                                     % Problem 17.
>> A = [ 0 -3 1 -9                     % The Constant terms.
         2 0 1 18                      % The x terms.
         0 0 0 0                       % The x^2 terms.
         0 1 -4 1];                   % The x^3 terms.
>> rref(A)
ans =
     1.0000     0     0     8.7273
     0     1.0000     0     3.1818
     0     0     1.0000     0.5455
     0     0     0     0
```

These are linearly dependent. The fourth polynomial is 8.7273 times the first plus 3.1818 times the second plus 0.5455 times the third. To verify this:

```
>> 8.7273*A(:,1) + 3.1818*A(:,2) + 0.5455*A(:,3)
ans =
    -8.9999
    18.0001
     0
     0.9998
```

Notice we only used 4 decimal places for the solution, and `ans` only agrees with `A(:,4)` to about 4 digits.

12. In order to work this problem, the matrices will be entered as vectors.

```
>> M1 = [ 2 -1; 4 0];           % Question 18.
>> M2 = [ 0 -3; 1 5]; M3 = [ 4 1; 7 -5];
>> v1 = [ M1(:,1) ; M1(:,2)]
v1 =
     2
     4
    -1
     0

>> v2 = [ M2(:,1) ; M2(:,2)]
v2 =
     0
     1
    -3
     5

>> v3 = [ M3(:,1) ; M3(:,2)]
v3 =
     4
     7
     1
    -5

>> rref( [ v1 v2 v3])
ans =
     1     0     2
     0     1    -1
     0     0     0
     0     0     0
```

These are dependent: $M_3 = 2M_1 - 1M_2$.

```
>> 2*M1 - 1*M2           % This should be M3.
ans =
     4     1
     7    -5

>> M1 = [1 -1; 0 6]; M2 = [-1 0; 3 1]; % Question 19.
>> M3 = [1 1; -1 2]; M4 = [ 0 1; 1 0];
>> v1 = [ M1(:,1) ; M1(:,2)]; v2 = [ M2(:,1) ; M2(:,2)];
>> v3 = [ M3(:,1) ; M3(:,2)]; v4 = [ M4(:,1) ; M4(:,2)];
>> rref( [ v1 v2 v3 v4])
ans =
     1     0     0     0
     0     1     0     0
     0     0     1     0
     0     0     0     1
```

These are linearly independent.

```
>> M1 = [ -1 0; 1 2]; M2 = [2 3; 7 -4]; % Question 20.
>> M3 = [ 8 -5; 7 6]; M4 = [ 4 -1; 2 3]; M5 = [ 2 3; -1 4];
>> v1 = [ M1(:,1) ; M1(:,2)]; v2 = [ M2(:,1) ; M2(:,2)];
>> v3 = [ M3(:,1) ; M3(:,2)]; v4 = [ M4(:,1) ; M4(:,2)];
>> v5 = [ M5(:,1) ; M5(:,2)];
>> R = rref( [ v1 v2 v3 v4 v5])
R =
    1.0000         0         0         0    0.9697
         0    1.0000         0         0    0.0303
         0         0    1.0000         0   -1.2121
         0         0         0    1.0000    3.1515
```

These are dependent. The fifth matrix is a linear combination of the first four.

```
>> c = R(:,5); % The coefficients.
>> c(1)*M1 + c(2)*M2 + c(3)*M3 + c(4)*M4 % This should be M5.
ans =
    2.0000    3.0000
   -1.0000    4.0000
```

13. (a) In order to work this problem, we will need to convert the 2×2 matrices into a vectors in \mathbb{R}^4 .

```
>> A = round(10*(2*rand(2)-1)) % Generate a random matrix.
A =
     4     5
     8    -5

>> a = A(:) % This converts a matrix to a single column.
a =
     4
     8
     5
    -5
```

The two commands above are repeated for B , C , D , and E . Next we check the linear dependence of a , b , c , d , and e .

```
>> M = [ a b c d e]
M =
     4     9    -9   -10     4
     8    -2    -9    -2     2
     5     0     1    -9     9
    -5     7     3    -2     7

>> R = rref(M)
R =
    1.0000         0         0         0    7.2042
         0    1.0000         0         0    5.3266
         0         0    1.0000         0    4.2263
         0         0         0    1.0000    3.4719
```

From R , we see that e is a linear combination of the first four vectors. This corresponds to E being a linear combination of the first four matrices. To verify this:

```
>> E                                % The matrix E.
E =
     4     9
     2     7

>> R(1,5)*A + R(2,5)*B + R(3,5)*C + R(4,5)*D % This is E as a combination
                                                % of A, B, C and D.

ans =
     4.0000     9.0000
     1.9999     7.0001
```

This can be repeated for two other sets of random matrices.

(b) As in (a), we will convert the 2×3 matrices into a vectors in \mathbb{R}^6 .

```
>> A = round(10*(2*rand(2,3)-1)) % Generate a random matrix.
A =
    -9    -3     5
     5     3    10

>> a = [ A(:,1); A(:,2); A(:,3) ] % Convert a matrix into one column vector.
a =
    -9
     5
    -3
     3
     5
    10
```

This is repeated for B through G .

```
>> M = [ a b c d e f g]
M =
    -9    -3    -9     0     8    -4    -9
     5    -5     3    -5     8    10     0
    -3    10     8    -5    -9     0    -2
     3     4    -5    -3     8    -5    -4
     5     5    -1    -7     0    -8     8
    10     3     5     0     0     9     1

>> R = rref(M)
R =
     1.0000         0         0         0         0         0         0.8926
         0         1.0000         0         0         0         0        -0.9856
         0         0         1.0000         0         0         0        -0.3569
         0         0         0         1.0000         0         0        -0.7539
         0         0         0         0         1.0000         0        -1.0689
         0         0         0         0         0         1.0000        -0.3539
```

From R , we see that g is a linear combination of the first six vectors. This corresponds to G being a linear combination of the first six matrices. To verify this, compare G with the linear combination:

```
>> G                                % The matrix G.
G =
    -9    -2     8
     0    -4     1
```

```
>> R(1,7)*A + R(2,7)*B + R(3,7)*C + R(4,7)*D + R(5,7)*E + R(6,7)*F
ans =
   -9.0000   -2.0000    8.0000
    0.0000   -4.0000    1.0000
```

- (c) Any set of 9 or more matrices in M_{42} is linearly dependent. This can be tested in the same manner as in (a) and (b).
 (d) See solution for 45.

14. (a)

```
>> A = zeros(6,8);           % There are 6 nodes and 8 edges.
>> A(1,1) = -1; A(2,1) = 1; % Edge 1 leaves node 1 and enters node 2.
>> A(2,2) = -1; A(3,2) = 1; % Edge 2.
>> A(4,3) = -1; A(5,3) = 1; % Edge 3.
>> A(5,4) = -1; A(6,4) = 1; % Edge 4.
>> A(1,5) = -1; A(6,5) = 1; % Edge 5.
>> A(5,6) = -1; A(1,6) = 1; % Edge 6.
>> A(5,7) = -1; A(2,7) = 1; % Edge 7.
>> A(3,8) = -1; A(4,8) = 1; % Edge 8.
A =
   -1    0    0    0   -1    1    0    0
    1   -1    0    0    0    0    1    0
    0    1    0    0    0    0    0   -1
    0    0   -1    0    0    0    0    1
    0    0    1   -1    0   -1   -1    0
    0    0    0    1    1    0    0    0
```

(b)

```
>> rref([A(:,1) A(:,7) A(:,4) A(:,5)])
ans =
    1    0    0    1
    0    1    0   -1
    0    0    1    1
    0    0    0    0
    0    0    0    0
    0    0    0    0

>> rref([ A(:,1) A(:,7) A(:,6)])
ans =
    1    0   -1
    0    1    1
    0    0    0
    0    0    0
    0    0    0
    0    0    0
```

In each case, and for any closed loop, the columns are linearly dependent.

(c) One such set has edges 1, 2, 7, and 8.

```
>> rref([ A(:,1) A(:,2) A(:,7) A(:,8) ])
ans =
    1     0     0     0
    0     1     0     0
    0     0     1     0
    0     0     0     1
    0     0     0     0
    0     0     0     0
```

As long as there are no closed loops, the set columns will be linearly independent.

(d)

```
>> A = zeros(5,8); % There are 5 nodes and 8 edges.
>> A(1,1) = -1; A(1,3) = 1; A(1,6) = 1; A(1,4) = -1; % Node 1.
>> A(2,1) = 1; A(2,2) = -1; % Node 2.
>> A(3,4) = 1; A(3,7) = -1; A(3,5) = -1; % Node 3.
>> A(4,2) = 1; A(4,3) = -1; A(4,7) = 1; A(4,8) = 1; % Node 4.
>> A(5,8) = -1; A(5,6) = -1; A(5,5) = 1 % Node 5.
A =
   -1     0     1    -1     0     1     0     0
     1    -1     0     0     0     0     0     0
     0     0     0     1    -1     0    -1     0
     0     1    -1     0     0     0     1     1
     0     0     0     0     1    -1     0    -1
```

```
>> rref([ A(:,4) A(:,5) A(:,6) ]) % Edges 4, 5 and 6 form a cycle.
ans =
     1     0    -1
     0     1    -1
     0     0     0
     0     0     0
     0     0     0
```

```
>> rref([ A(:,1) A(:,3) A(:,6) A(:,4) ]) % Edges 1, 3, 6 and 4 have no loops.
ans =
     1     0     0     0
     0     1     0     0
     0     0     1     0
     0     0     0     1
     0     0     0     0
```

The columns corresponding to a loop were dependent, and those corresponding to a set with no loops were independent.

(e) If A is the incidence matrix for a digraph, then its columns are linearly independent if and only if the digraph has no cycles.

Section 4.6

1. no; two polynomials cannot span P_2 , see Solution 4.5.41.
2. yes; they are independent since $\det \begin{pmatrix} 0 & 1 & -5 \\ -3 & 0 & 0 \\ 0 & 1 & 1 \end{pmatrix} = 3(1+5) = 18 \neq 0$; they span since $\begin{pmatrix} 0 \\ -3 \\ 0 \end{pmatrix}, \begin{pmatrix} 1 \\ 0 \\ 1 \end{pmatrix}$, and $\begin{pmatrix} -5 \\ 0 \\ 1 \end{pmatrix}$ span \mathbb{R}^3 .
3. no; as $x^2 - 3 = (x^2 - 1) + (x^2 - 2)$, they are dependent.
4. yes; as $\det \begin{pmatrix} 1 & 1 & 1 & 1 \\ 0 & 1 & 0 & 0 \\ 0 & 0 & 1 & 0 \\ 0 & 0 & 0 & 1 \end{pmatrix} = 1 \neq 0$, they are independent and span the 4 dimensional space P_3 , by Theorem 5.
5. no; three polynomials cannot span P_3 . (Any linear combination of these three will have $ax^3 - 4ax + bx^2 + c$. So x^3 or x not in span.)
6. no; $\begin{pmatrix} 0 & 0 \\ 1 & 0 \end{pmatrix} \notin \text{span} \left\{ \begin{pmatrix} 3 & 1 \\ 0 & 0 \end{pmatrix}, \begin{pmatrix} 3 & 2 \\ 0 & 0 \end{pmatrix}, \begin{pmatrix} -5 & 1 \\ 0 & 6 \end{pmatrix}, \begin{pmatrix} 0 & 1 \\ 0 & -7 \end{pmatrix} \right\}$. (Show $a_1 \begin{pmatrix} 3 & 1 \\ 0 & 0 \end{pmatrix} + a_2 \begin{pmatrix} 3 & 2 \\ 0 & 0 \end{pmatrix} + a_3 \begin{pmatrix} -5 & 1 \\ 0 & 6 \end{pmatrix} + a_4 \begin{pmatrix} 0 & 1 \\ 0 & -7 \end{pmatrix} = \begin{pmatrix} a & b \\ c & d \end{pmatrix}$ can not always be solved.)
7. As $abcd \neq 0$, then a, b, c , and d are all nonzero. Thus, $c_1 \begin{pmatrix} a & 0 \\ 0 & 0 \end{pmatrix} + c_2 \begin{pmatrix} 0 & b \\ 0 & 0 \end{pmatrix} + c_3 \begin{pmatrix} 0 & 0 \\ c & 0 \end{pmatrix} + c_4 \begin{pmatrix} 0 & 0 \\ 0 & d \end{pmatrix} = 0$ implies $c_i = 0$ for each i . $\begin{pmatrix} \alpha & \beta \\ \gamma & \rho \end{pmatrix} = \frac{\alpha}{a} \begin{pmatrix} a & 0 \\ 0 & 0 \end{pmatrix} + \frac{\beta}{b} \begin{pmatrix} 0 & b \\ 0 & 0 \end{pmatrix} + \frac{\gamma}{c} \begin{pmatrix} 0 & 0 \\ c & 0 \end{pmatrix} + \frac{\rho}{d} \begin{pmatrix} 0 & 0 \\ 0 & d \end{pmatrix}$. Hence they are independent and span, so form a basis for M_{22} .
8. As M_{22} has a basis consisting of 4 matrices, then theorem 2 implies every basis for M_{22} contains 4 matrices. Thus the given set of matrices is not a basis for M_{22} . (Any 5 matrices in M_2 are dependent.)
9. yes; given $(x, y) \in H$, then $(x, y) = (x, -x) = x(1, -1)$
10. no; they are dependent since $(-3, 3) = -3(1, -1)$, so not a basis.
11. $\begin{pmatrix} x \\ y \\ z \end{pmatrix} = \begin{pmatrix} x \\ y \\ 2x - y \end{pmatrix} = x \begin{pmatrix} 1 \\ 0 \\ 2 \end{pmatrix} + y \begin{pmatrix} 0 \\ 1 \\ -1 \end{pmatrix}; \left\{ \begin{pmatrix} 1 \\ 0 \\ 2 \end{pmatrix}, \begin{pmatrix} 0 \\ 1 \\ -1 \end{pmatrix} \right\}$ is a basis.
12. $\begin{pmatrix} x \\ y \\ z \end{pmatrix} = \begin{pmatrix} (2/3)y - 2z \\ y \\ z \end{pmatrix} = y \begin{pmatrix} 2/3 \\ 1 \\ 0 \end{pmatrix} + z \begin{pmatrix} -2 \\ 0 \\ 1 \end{pmatrix}; \left\{ \begin{pmatrix} 2/3 \\ 1 \\ 0 \end{pmatrix}, \begin{pmatrix} -2 \\ 0 \\ 1 \end{pmatrix} \right\}$ is a basis.
13. $\begin{pmatrix} x \\ y \\ z \end{pmatrix} = \begin{pmatrix} x \\ (3/2)x \\ 2x \end{pmatrix} = x \begin{pmatrix} 1 \\ 3/2 \\ 2 \end{pmatrix}; \left\{ \begin{pmatrix} 1 \\ 3 \\ 4 \end{pmatrix} \right\}$ 14. $\begin{pmatrix} x \\ y \\ z \end{pmatrix} = \begin{pmatrix} 3t \\ -2t \\ t \end{pmatrix} = t \begin{pmatrix} 3 \\ -2 \\ 1 \end{pmatrix}; \left\{ \begin{pmatrix} 3 \\ -2 \\ 1 \end{pmatrix} \right\}$
15. As $\dim \mathbb{R}^2 = 2$, a proper subspace H must have dimension 1. Thus, $H = \text{span} \{(x_0, y_0)\}$ for some $(x_0, y_0) \in \mathbb{R}^2$. So for every $(x, y) \in H$, $(x, y) = t(x_0, y_0)$ for some $t \in \mathbb{R}$. Hence, $x = tx_0$ and $y = ty_0$, which is the equation of a line through the origin.

16. (a) Suppose (x_1, y_1, z_1, w_1) and (x_2, y_2, z_2, w_2) are in H . Then $a(x_1 + x_2) + b(y_1 + y_2) + c(z_1 + z_2) + d(w_1 + w_2) = ax_1 + by_1 + cz_1 + dw_1 + ax_2 + by_2 + cz_2 + dw_2 = 0$, and $a(\alpha x_1) + b(\alpha y_1) + c(\alpha z_1) + d(\alpha w_1) = \alpha(ax_1 + by_1 + cz_1 + dw_1) = 0$. Thus H is a subspace of \mathbb{R}^4 .

(b) As $abcd \neq 0$, a is nonzero. Then
$$\begin{pmatrix} x \\ y \\ z \\ w \end{pmatrix} = \begin{pmatrix} -(by + cz + dw)/a \\ y \\ z \\ w \end{pmatrix} = y \begin{pmatrix} -b/a \\ 1 \\ 0 \\ 0 \end{pmatrix} + z \begin{pmatrix} -c/a \\ 0 \\ 1 \\ 0 \end{pmatrix} + w \begin{pmatrix} -d/a \\ 0 \\ 0 \\ 1 \end{pmatrix}.$$
 Hence a basis for H is $\left\{ \begin{pmatrix} -b/a \\ 1 \\ 0 \\ 0 \end{pmatrix}, \begin{pmatrix} -c/a \\ 0 \\ 1 \\ 0 \end{pmatrix}, \begin{pmatrix} -d/a \\ 0 \\ 0 \\ 1 \end{pmatrix} \right\}$.

(c) $\dim H = 3$.

17. Let $\{v_1, v_2, \dots, v_{n-1}\}$ be a basis for H . Let $\mathbf{a} = (a_1, a_2, \dots, a_n)$. As $\mathbf{a} \cdot \mathbf{v}_i = 0$ is a homogeneous system of $n - 1$ equations with n unknowns, there is a nontrivial solution \mathbf{a} . Let $\mathbf{v} = (x_1, x_2, \dots, x_n)$

be in H . So $\mathbf{v} = \sum_{i=1}^{n-1} c_i \mathbf{v}_i$ where $c_i \in \mathbb{R}$. Then $\mathbf{a} \cdot \mathbf{v} = \mathbf{a} \cdot \left(\sum_{i=1}^{n-1} c_i \mathbf{v}_i \right) = \sum_{i=1}^{n-1} c_i (\mathbf{a} \cdot \mathbf{v}_i) = 0$. Thus

$a_1 x_1 + a_2 x_2 + \dots + a_n x_n = 0$, which proves the result, since the $n - 1$ dimensional space of solutions must coincide with H .

18.
$$\begin{pmatrix} x_1 \\ x_2 \\ x_3 \\ x_4 \\ x_5 \end{pmatrix} = \begin{pmatrix} x_1 \\ x_2 \\ x_3 \\ x_4 \\ 2x_1 - 3x_2 + x_3 + 4x_4 \end{pmatrix} = x_1 \begin{pmatrix} 1 \\ 0 \\ 0 \\ 0 \\ 2 \end{pmatrix} + x_2 \begin{pmatrix} 0 \\ 1 \\ 0 \\ 0 \\ -3 \end{pmatrix} = x_3 \begin{pmatrix} 0 \\ 0 \\ 1 \\ 0 \\ 1 \end{pmatrix} + x_4 \begin{pmatrix} 0 \\ 0 \\ 0 \\ 1 \\ 4 \end{pmatrix}.$$
 Hence the vectors $\begin{pmatrix} 1 \\ 0 \\ 0 \\ 0 \\ 2 \end{pmatrix}, \begin{pmatrix} 0 \\ 1 \\ 0 \\ 0 \\ -3 \end{pmatrix}, \begin{pmatrix} 0 \\ 0 \\ 1 \\ 0 \\ 1 \end{pmatrix}$, and $\begin{pmatrix} 0 \\ 0 \\ 0 \\ 1 \\ 4 \end{pmatrix}$ form a basis for H .

19. $\left(\begin{array}{cc|c} 1 & -1 & 0 \\ -2 & 2 & 0 \end{array} \right) \rightarrow \left(\begin{array}{cc|c} 1 & -1 & 0 \\ 0 & 0 & 0 \end{array} \right) \quad \begin{pmatrix} x \\ y \end{pmatrix} = \begin{pmatrix} y \\ y \end{pmatrix} = y \begin{pmatrix} 1 \\ 1 \end{pmatrix}.$ Thus a basis for the solution space is $\left\{ \begin{pmatrix} 1 \\ 1 \end{pmatrix} \right\}$.

20. $\left(\begin{array}{cc|c} 1 & -2 & 0 \\ 3 & 1 & 0 \end{array} \right) \rightarrow \left(\begin{array}{cc|c} 1 & 0 & 0 \\ 0 & 1 & 0 \end{array} \right).$ The solution space is the trivial subspace.

21. $\left(\begin{array}{ccc|c} 1 & -1 & -1 & 0 \\ 2 & -1 & 1 & 0 \end{array} \right) \rightarrow \left(\begin{array}{ccc|c} 1 & 0 & 2 & 0 \\ 0 & 1 & 3 & 0 \end{array} \right) \quad \begin{pmatrix} x \\ y \\ z \end{pmatrix} = \begin{pmatrix} -2z \\ -3z \\ z \end{pmatrix} = z \begin{pmatrix} -2 \\ -3 \\ 1 \end{pmatrix}.$ Thus $\left\{ \begin{pmatrix} -2 \\ -3 \\ 1 \end{pmatrix} \right\}$ is a basis for the solution space.

22. $\left(\begin{array}{ccc|c} 1 & -3 & 1 & 0 \\ -2 & 2 & -3 & 0 \\ 4 & -8 & 5 & 0 \end{array} \right) \rightarrow \left(\begin{array}{ccc|c} 1 & 0 & 7/4 & 0 \\ 0 & 1 & 1/4 & 0 \\ 0 & 0 & 0 & 0 \end{array} \right) \quad \begin{pmatrix} x \\ y \\ z \end{pmatrix} = z \begin{pmatrix} -7/4 \\ -1/4 \\ 1 \end{pmatrix}.$ A basis for the solution space is $\left\{ \begin{pmatrix} 7 \\ 1 \\ -4 \end{pmatrix} \right\}$.

$$23. \left(\begin{array}{ccc|c} 2 & -6 & 4 & 0 \\ -1 & 3 & -2 & 0 \\ -3 & 9 & -6 & 0 \end{array} \right) \rightarrow \left(\begin{array}{ccc|c} 1 & -3 & 2 & 0 \\ 0 & 0 & 0 & 0 \\ 0 & 0 & 0 & 0 \end{array} \right) \quad \begin{pmatrix} x \\ y \\ z \end{pmatrix} = y \begin{pmatrix} 3 \\ 1 \\ 0 \end{pmatrix} + z \begin{pmatrix} -2 \\ 0 \\ 1 \end{pmatrix} \quad \left\{ \begin{pmatrix} 3 \\ 1 \\ 0 \end{pmatrix}, \begin{pmatrix} -2 \\ 0 \\ 1 \end{pmatrix} \right\} \text{ is a basis}$$

for the solution space.

$$24. \left\{ \begin{pmatrix} 1 & 0 & 0 \\ 0 & 0 & 0 \\ 0 & 0 & 0 \end{pmatrix}, \begin{pmatrix} 0 & 0 & 0 \\ 0 & 1 & 0 \\ 0 & 0 & 0 \end{pmatrix}, \begin{pmatrix} 0 & 0 & 0 \\ 0 & 0 & 0 \\ 0 & 0 & 1 \end{pmatrix} \right\}; \dim D_3 = 3.$$

25. For $i = 1, 2, \dots, n$, let B_i be an $n \times n$ matrix with $b_{ii} = 1$ and 0's everywhere else. Then $\{B_1, B_2, \dots, B_n\}$ is a basis for D_n . Hence $\dim D_n = n$.

26. Let $A \in S_{nn}$ and $B \in S_{nn}$. Then $A + B = A^t + B^t = (A + B)^t$. Hence $A + B \in S_{nn}$. Moreover, $\alpha A = \alpha A^t = (\alpha A)^t$. So $\alpha A \in S_{nn}$. By Theorem 4.3.1, S_{nn} is a subspace of M_{nn} . For $i \leq j$, let B_{ij} be the $n \times n$ matrix with $b_{ij} = b_{ji} = 1$ and 0's elsewhere. Note that each B_{ij} is symmetric, they are linearly independent, and every symmetric matrix can be written as a linear combination of the B_{ij} 's. Thus $\{B_{ij} : 1 \leq i \leq j \leq n\}$ is a basis for S_{nn} , and $\dim S_{nn} = n + (n-1) + (n-2) + \dots + 2 + 1 = \sum_{k=1}^n k = \frac{n(n+1)}{2}$.

27. Use induction on m . Let $\{\mathbf{u}_1, \mathbf{u}_2, \dots, \mathbf{u}_n\}$ be a basis for V . Suppose $m = n - 1$; then some $\mathbf{u}_i \notin \text{span}\{\mathbf{v}_1, \mathbf{v}_2, \dots, \mathbf{v}_m\}$. By problem 4.5.56, $\{\mathbf{v}_1, \mathbf{v}_2, \dots, \mathbf{v}_m, \mathbf{u}_i\}$ is a linear independent set containing n vectors. By theorem 5, $\{\mathbf{v}_1, \mathbf{v}_2, \dots, \mathbf{v}_m, \mathbf{u}_i\}$ is a basis for V . Now suppose $m < n$ and that the claim holds true for $m + 1$ linearly independent vectors. As before, some $\mathbf{u}_i \notin \text{span}\{\mathbf{v}_1, \mathbf{v}_2, \dots, \mathbf{v}_m\}$. So $\{\mathbf{v}_1, \mathbf{v}_2, \dots, \mathbf{v}_m, \mathbf{u}_i\}$ is a set of $m + 1$ linearly independent vectors. By the induction hypothesis, this set can be extended to a basis for V , which proves the claim.

28. By problem 4.5.48, they are linearly independent. By theorem 5, they constitute a basis for V .

29. If the vectors are linearly independent, then they form a basis for V . Hence $\dim V = n$. If they are dependent, by problem 4.5.49, at least one of the vectors can be written as a linear combination of the vectors that precede it. Throw this vector out. Continue in this manner until m linearly independent vectors are obtained. By construction, this set still spans V . Thus $\dim V = m < n$. In either case, we have $\dim V \leq n$.

30. Suppose there exists $\mathbf{v} \in K$ such that $\mathbf{v} \notin H$. Let $\{\mathbf{u}_1, \mathbf{u}_2, \dots, \mathbf{u}_n\}$ be a basis for H . Then $\{\mathbf{u}_1, \mathbf{u}_2, \dots, \mathbf{u}_n, \mathbf{v}\}$ is a linearly independent set contained in K . This implies $\dim K \geq n + 1 > n = \dim H$, which is a contradiction. Thus $H = K$.

31. (a) $(h_1 + k_1) + (h_2 + k_2) = (h_1 + h_2) + (k_1 + k_2) \in H + K$; $\alpha(h + k) = \alpha h + \alpha k \in H + K$.
 (b) Let $\{\mathbf{u}_1, \mathbf{u}_2, \dots, \mathbf{u}_m\}$ be a basis for H and $\{\mathbf{v}_1, \mathbf{v}_2, \dots, \mathbf{v}_n\}$ be a basis for K . Let $B = \{\mathbf{u}_1, \mathbf{u}_2, \dots, \mathbf{u}_m, \mathbf{v}_1, \mathbf{v}_2, \dots, \mathbf{v}_n\}$. Clearly, B spans $H + K$. Suppose $\alpha_1 \mathbf{u}_1 + \alpha_2 \mathbf{u}_2 + \dots + \alpha_m \mathbf{u}_m + \beta_1 \mathbf{v}_1 + \beta_2 \mathbf{v}_2 + \dots + \beta_n \mathbf{v}_n = \mathbf{0}$. Then $\alpha_1 \mathbf{u}_1 + \alpha_2 \mathbf{u}_2 + \dots + \alpha_m \mathbf{u}_m = -\beta_1 \mathbf{v}_1 - \beta_2 \mathbf{v}_2 - \dots - \beta_n \mathbf{v}_n \in H \cap K = \{\mathbf{0}\}$. Thus $\alpha_1 \mathbf{u}_1 + \alpha_2 \mathbf{u}_2 + \dots + \alpha_m \mathbf{u}_m = \beta_1 \mathbf{v}_1 + \beta_2 \mathbf{v}_2 + \dots + \beta_n \mathbf{v}_n = \mathbf{0}$. It follows that $\alpha_i = \beta_j = 0$ for each i and j . So B is a basis for $H + K$. Hence $\dim(H + K) = \dim H + \dim K$.

32. If $H = V$, then $K = \{\mathbf{0}\}$. If $H = \{\mathbf{0}\}$, then $K = V$. Suppose H is a proper subspace. Let $\{\mathbf{v}_1, \mathbf{v}_2, \dots, \mathbf{v}_k\}$ be a basis for H and let $\dim V = n$. By problem 27, there exist vectors $\mathbf{v}_{k+1}, \mathbf{v}_{k+2}, \dots, \mathbf{v}_n$ such that $\{\mathbf{v}_1, \mathbf{v}_2, \dots, \mathbf{v}_n\}$ is a basis for V . Let $K = \text{span}\{\mathbf{v}_{k+1}, \mathbf{v}_{k+2}, \dots, \mathbf{v}_n\}$. Clearly $H + K = V$. Suppose

$$\mathbf{v} \in H \cap K. \text{ Then } \mathbf{v} = \sum_{i=1}^k \alpha_i \mathbf{v}_i = \sum_{i=k+1}^n \beta_i \mathbf{v}_i, \text{ which gives } \sum_{i=1}^k \alpha_i \mathbf{v}_i - \sum_{i=k+1}^n \beta_i \mathbf{v}_i = \mathbf{0}. \text{ Thus each}$$

$\alpha_i = 0$ and each $\beta_j = 0$, and it follows that $H \cap K = \{\mathbf{0}\}$. It is false that K is unique, for instance if

$$H = \left\{ \alpha \begin{pmatrix} 1 \\ 0 \end{pmatrix} \right\} = x\text{-axis in } \mathbb{R}^2, K \text{ can be any line through } 0, \text{ with non-zero slope.}$$

33. Suppose \mathbf{v}_1 and \mathbf{v}_2 are colinear. Then $\mathbf{v}_2 = \alpha\mathbf{v}_1$ for some scalar α . Thus $\{\mathbf{v}_1\}$ is a basis for $\text{span}\{\mathbf{v}_1, \mathbf{v}_2\}$ and $\dim \text{span}\{\mathbf{v}_1, \mathbf{v}_2\} = 1$. Conversely, suppose $\dim \text{span}\{\mathbf{v}_1, \mathbf{v}_2\} = 1$. Let $\{\mathbf{v}\}$ be a basis for $\text{span}\{\mathbf{v}_1, \mathbf{v}_2\}$. Then $\mathbf{v}_1 = \alpha\mathbf{v}$ and $\mathbf{v}_2 = \beta\mathbf{v}$. As $\dim \text{span}\{\mathbf{v}_1, \mathbf{v}_2\} = 1$, either $\alpha \neq 0$ or $\beta \neq 0$.

We may assume $\alpha \neq 0$. Then $\mathbf{v}_2 = \frac{\beta}{\alpha}\mathbf{v}_1$ which shows they are colinear.

34. Suppose $\mathbf{v}_1, \mathbf{v}_2$, and \mathbf{v}_3 are coplanar. If the vectors are parallel, $\dim \text{span}\{\mathbf{v}_1, \mathbf{v}_2, \mathbf{v}_3\} = 1$. If at least two of the vectors are not parallel, then $\dim \text{span}\{\mathbf{v}_1, \mathbf{v}_2, \mathbf{v}_3\} = 2$. Hence, in either case $\dim \text{span}\{\mathbf{v}_1, \mathbf{v}_2, \mathbf{v}_3\} \leq 2$. Conversely, suppose $\dim \text{span}\{\mathbf{v}_1, \mathbf{v}_2, \mathbf{v}_3\} \leq 2$. If the dimension is 1, let $\{\mathbf{v}\}$ be a basis. Then $\mathbf{v}_1 = \alpha\mathbf{v}$, $\mathbf{v}_2 = \beta\mathbf{v}$, and $\mathbf{v}_3 = \gamma\mathbf{v}$. Since the dimension is 1, either α, β , or γ is

nonzero. We may assume $\alpha \neq 0$. Then $\mathbf{v}_2 = \frac{\beta}{\alpha}\mathbf{v}_1$ and $\mathbf{v}_3 = \frac{\gamma}{\alpha}\mathbf{v}_1$, which shows the vectors are parallel.

If the dimension is 2, let $\{\mathbf{u}, \mathbf{v}\}$ be a basis. Then $\mathbf{v}_1 = \alpha_1\mathbf{u} + \beta_1\mathbf{v}$, $\mathbf{v}_2 = \alpha_2\mathbf{u} + \beta_2\mathbf{v}$, and $\mathbf{v}_3 = \alpha_3\mathbf{u} + \beta_3\mathbf{v}$. Thus

$$\begin{aligned} \mathbf{v}_1 \cdot (\mathbf{v}_2 \times \mathbf{v}_3) &= \mathbf{v}_1 \cdot [\alpha_2\alpha_3(\mathbf{u} \times \mathbf{u}) + \beta_2\alpha_3(\mathbf{v} \times \mathbf{u}) + \alpha_2\beta_3(\mathbf{u} \times \mathbf{v}) + \beta_2\beta_3(\mathbf{v} \times \mathbf{v})] \\ &= \alpha_1(\alpha_2\beta_3 - \beta_2\alpha_3)[\mathbf{u} \cdot (\mathbf{u} \times \mathbf{v})] + \beta_1(\alpha_2\beta_3 - \beta_2\alpha_3)[\mathbf{v} \cdot (\mathbf{u} \times \mathbf{v})] \\ &= 0. \end{aligned}$$

By problem 3.5.59, $\mathbf{v}_1, \mathbf{v}_2$, and \mathbf{v}_3 are coplanar. So in either case the vectors are coplanar.

35. Suppose the vectors are dependent. Then we could throw out one of the vectors and still have a set that spans V , which would imply $\dim V < n$. Thus the vectors are independent and, hence, form a basis for V .
36. If $H = V$, then H has a basis. Suppose H is a proper subspace of V , then as V is finite dimensional, it follows that H is spanned by a finite number of vectors. Let $\{\mathbf{v}_1, \mathbf{v}_2, \dots, \mathbf{v}_k\}$ be a subset of H which spans H . By the method used in problem 29, we can reduce this spanning set until we have a set that spans H and is linearly independent. Thus H has a basis.
37. $\{(1, 0, 1, 0), (0, 1, 0, 1), (1, 0, 0, 0), (0, 1, 0, 0)\}$ and $\{(1, 0, 1, 0), (0, 1, 0, 1), (0, 0, 1, 0), (0, 0, 0, 1)\}$

38. $\begin{vmatrix} a & 1 & 1+a \\ 1 & 0 & 1 \\ 0 & a & a \end{vmatrix} = \begin{vmatrix} a & 1 & a \\ 1 & 0 & 1 \\ 0 & a & 0 \end{vmatrix} = -a(a-a) = 0$. The vectors never form a basis for \mathbb{R}^3 , since for all values of a the vectors are dependent.

MATLAB 4.6

1. (a) In each case, the matrix formed by the vectors reduces to the identity matrix in row echelon form. This means that they are linearly independent, and by theorem 5 they form a basis since we are dealing with n vectors in a space known to have dimension n .

(i)

```
>> A = [ 8.25 1.01 10; 7 -7 -6.5; 8 -1 -1];
>> rref(A)
ans =
    1    0    0
    0    1    0
    0    0    1

>> w = 2*rand(3,1)-1           % For part (b).
w =
    0.5230
    0.5404
    0.6556

>> c = A\w                     % Solve Ac = w.
c =
    0.0825
    0.0219
   -0.0179
>> c(1)*A(:,1) + c(2)*A(:,2) + c(3)*A(:,3) % Write w as a linear combination.
ans =
    0.5230
    0.5404
    0.6556
```

(ii)

```
>>
>> A = [1 1 2 -1 1; -1 0 4 -1 1; 0 3 -1 2 1; 2 -1 3 -1 1; 1 1 1 1 1];
>> rref(A)
ans =
    1    0    0    0    0
    0    1    0    0    0
    0    0    1    0    0
    0    0    0    1    0
    0    0    0    0    1

>> w = 2*rand(5,1)-1           % For part b.
w =
   -0.7493
   -0.9683
    0.3769
    0.7365
    0.2591

>> c = A\w                     % Solve Ac = w.
c =
   -0.9345
   -2.3096
   -2.1988
   -0.5952
    6.2972
```



```
>> c(1)*A(:,1) + c(2)*A(:,2) ... % Write w as a linear combination.
      + c(3)*A(:,3) + c(4)*A(:,4) + c(5)*A(:,5)
ans =
-0.7493
-0.9683
 0.3769
 0.7365
 0.2591
```

(iii) For this part, we must first convert the 2×2 matrices into column vectors in \mathbb{R}^4 .

```
>> A = [ 1 -1; 1.2 2.1]; B = [ 2 1; -1 1]; % Enter the matrices.
>> C = [ 1 3; -2 0]; D = [ -1.5 4; 4.3 5];
>> a = [ A(:,1); A(:,2)] % Convert them to vectors.
a =
 1.0000
 1.2000
-1.0000
 2.1000
>> b = [ B(:,1); B(:,2)];
>> c = [ C(:,1); C(:,2)];
>> d = [ D(:,1); D(:,2)];
>> M = [a b c d] % Form the matrix of vectors.

M =
 1.0000  2.0000  1.0000 -1.5000
 1.2000 -1.0000 -2.0000  4.3000
-1.0000  1.0000  3.0000  4.0000
 2.1000  1.0000  0  5.0000

>> rref(M) % Check for linear independence.
ans =
 1  0  0  0
 0  1  0  0
 0  0  1  0
 0  0  0  1

>> W = 2*rand(2)-1 % Make a random matrix for part (b).
W =
 0.4724  0.9989
 0.4508  0.7771

>> w = [ W(:,1); W(:,2)] % Convert W to a vector.
w =
 0.4724
 0.4508
 0.9989
 0.7771

>> c = M\w % Solve Mc = w.
c =
-1.0916
 1.4930
-0.9490
 0.3153
```

```
>> c(1)*A + c(2)*B + c(3)*C + c(4)*D % Compare w with this linear combination.
ans =
    0.4724    0.9989
    0.4508    0.7771
```

(iv) We must convert polynomials to vectors in \mathbb{R}^5 .

```
>> p1 = [ 1; 2; 0; -1; 1]; p2 = [ 4; -1; 3; 0; 1];
>> p3 = [ 5; 3; -1; 4; 2]; p4 = [ 0; 1; -2; 1; 1];
>> p5 = [ 1; 1; 1; 1; 1];
>> A = [p1 p2 p3 p4 p5]
A =
     1     4     5     0     1
     2    -1     3     1     1
     0     3    -1    -2     1
    -1     0     4     1     1
     1     1     2     1     1

>> rref(A)
ans =
     1     0     0     0     0
     0     1     0     0     0
     0     0     1     0     0
     0     0     0     1     0
     0     0     0     0     1

>> w = 2*rand(5,1)-1 % For part (b).
w =
   -0.5336
   -0.3874
   -0.2980
    0.0265
    0.1822

>> c = A\w % Solve Ac = w.
c =
   -0.1647
    0.1083
   -0.1884
    0.4755
    0.1399

>> c(1)*p1 + c(2)*p2 + c(3)*p3 + c(4)*p4 + c(5)*p5 % Compare with w.
ans =
   -0.5336
   -0.3874
   -0.2980
    0.0265
    0.1822
```

2. See the answer to problem 9, MATLAB 4.5. In each case, the matrix of vectors is reduced to row echelon form. Since there are no zero rows, the system $[A \ w]$ will have a solution for any w . Therefore the set spans all of \mathbb{R}^n . However, since there is a column without a pivot, the vectors are not linearly independent. Thus they are not a basis. Below, a random vector w is generated, and the system $[A \ w]$ is reduced to echelon form. In each case there is a free variable.

(i)

```
>> A = [ 1 3 -1; 2 -1 0];
>> w = 2*rand(2,1)-1
w =
    0.3577
    0.3586

>> rref([A w])
ans =
    1.0000         0   -0.1429    0.2048
         0    1.0000   -0.2857    0.0510
```

(ii)

```
>> A = [ 1 -1 2 1; 0 2 -1 1; 1 3 0 4];
>> w = 2*rand(3,1)-1
w =
    0.8694
   -0.2330
    0.0388

>> rref([A w])
ans =
    1.0000         0    1.5000         0    1.2997
         0    1.0000   -0.5000         0    0.0658
         0         0         0    1.0000   -0.3646
```

(iii)

```
>> A = [ 4 3 0 7 1 1; -1 2 1 2 1 1; 3 2 2 7 -1 1; 1 2 2 5 0 1];
>> w = 2*rand(4,1)-1
w =
    0.6619
   -0.9309
   -0.8931
    0.0594

>> rref([A w])
ans =
    1.0000         0         0    1.0000         0   -0.1111    1.2108
         0    1.0000         0    1.0000         0    0.5556   -2.5184
         0         0    1.0000    1.0000         0    0.0000    1.9427
         0         0         0         0    1.0000   -0.2222    3.3741
```

3. (a) See the answer for problem 1 above, to see how to enter these matrices. In each case, the first vector is removed from the set. The new set is made from the columns of the new matrix B . The resulting set is not a basis because the vectors no longer span.

(i)

```
>> A = [ 8.25 1.01 10; 7 -7 -6.5; 8 -1 -1];
>> B = A(:, [2:3] )
B =
    1.0100    10.0000
   -7.0000   -6.5000
   -1.0000   -1.0000

>> rref(B)
ans =
     1     0
     0     1
     0     0
```

(ii)

```
>> A = [1 1 2 -1 1; -1 0 4 -1 1; 0 3 -1 2 1; 2 -1 3 -1 1; 1 1 1 1 1];
>> B = A(:, [2:5] )
B =
     1     2    -1     1
     0     4    -1     1
     3    -1     2     1
    -1     3    -1     1
     1     1     1     1

>> rref(B)
ans =
     1     0     0     0
     0     1     0     0
     0     0     1     0
     0     0     0     1
     0     0     0     0
```

(iii)

```
>> M = [a b c d];
>> B = M(:, [2:4] )
B =
    2.0000    1.0000   -1.5000
   -1.0000   -2.0000    4.3000
    1.0000    3.0000    4.0000
    1.0000         0    5.0000

>> rref(B)
ans =
     1     0     0
     0     1     0
     0     0     1
     0     0     0
```

(iv)

```

>> A = [p1 p2 p3 p4 p5];
>> B = A(:, [2:5] )
B =
     4     5     0     1
    -1     3     1     1
     3    -1    -2     1
     0     4     1     1
     1     2     1     1

>> rref(B)
ans =
     1     0     0     0
     0     1     0     0
     0     0     1     0
     0     0     0     1
     0     0     0     0

```

(b) For each set, a vector w is generated, and then a new matrix $B = [w A]$ is entered. The resulting set is not a basis because the set is not linearly independent, as seen by the column without a pivot.

(i)

```

>> A = [ 8.25 1.01 10; 7 -7 -6.5; 8 -1 -1];
>> B = [ round( 5*(2*rand(3,1)-1)) A]
B =
   -4.0000    8.2500    1.0100   10.0000
   -1.0000    7.0000   -7.0000   -6.5000
    2.0000    8.0000   -1.0000   -1.0000

>> rref(B)
ans =
   1.0000         0         0   -1.3120
         0    1.0000         0    0.3914
         0         0    1.0000    1.5074

```

(ii)

```

>> A = [1 1 2 -1 1; -1 0 4 -1 1; 0 3 -1 2 1; 2 -1 3 -1 1; 1 1 1 1 1];
>> B = [ round( 5*(2*rand(5,1)-1)) A]
B =
     1     1     1     2    -1     1
     4    -1     0     4    -1     1
     3     0     3    -1     2     1
     0     2    -1     3    -1     1
    -4     1     1     1     1     1

>> rref(B)
ans =
   1.0000         0         0         0         0    0.0202
         0    1.0000         0         0         0    0.2348
         0         0    1.0000         0         0    0.2794
         0         0         0    1.0000         0    0.3441
         0         0         0         0    1.0000    0.2227

```

(iii)

```

>> M = [a b c d];
>> B = [ round( 5*(2*rand(4,1)-1)) M]
B =
    2.0000    1.0000    2.0000    1.0000   -1.5000
   -1.0000    1.2000   -1.0000   -2.0000    4.3000
    2.0000   -1.0000    1.0000    3.0000    4.0000
    4.0000    2.1000    1.0000         0    5.0000

>> rref(B)
ans =
    1.0000         0         0         0   -1.6629
         0    1.0000         0         0    9.2472
         0         0    1.0000         0   -7.7674
         0         0         0    1.0000    8.1135

```

(iv)

```

>> A = [p1 p2 p3 p4 p5];
>> B = [ round( 5*(2*rand(5,1)-1)) A]
B =
     3     1     4     5     0     1
    -2     2    -1     3     1     1
    -5     0     3    -1    -2     1
     2    -1     0     4     1     1
    -2     1     1     2     1     1

>> rref(B)
ans =
    1.0000         0         0         0         0   -0.2281
         0    1.0000         0         0         0   -0.1754
         0         0    1.0000         0         0    0.0702
         0         0         0    1.0000         0    0.3158
         0         0         0         0    1.0000    0.0175

```

(c) Assume that A is a matrix whose columns form a basis for \mathbb{R}^n . Since the columns are in \mathbb{R}^n then A is an $n \times m$ matrix. We wish to show that $m = n$. Let R be the reduced row echelon form of A . Since the columns of A span \mathbb{R}^n , every row of R must have a pivot. This tells us there are n pivots. Since the columns of A are linearly independent, every column of R must have a pivot. Thus there are n columns, and the proof is done.

4. (a) The following lines of code should be repeated 5 times.

```

>> M = round(10*(2*rand(3,2)-1)); % Generate a random matrix.
>> v = [ M(:,1); M(:,2)]; % Convert it to a vector.
>> % After generating a vector, do one of the
>> % following lines of code. Either:
>> A = v % Start a new list of vectors the first time.
>> % Or:
>> A = [ A v] % Add v to the list of vectors.

```

```
A =
     3     4    -5    -3     8
     5     5    -1    -7     0
    10     3     5     0     0
    -3    -9     0     8    -4
    -5     3    -5     8    10
    10     8    -5    -9     0
```

```
>> rref(A)
```

```
ans =
     1     0     0     0     0
     0     1     0     0     0
     0     0     1     0     0
     0     0     0     1     0
     0     0     0     0     1
     0     0     0     0     0
```

This set does not span, since there is a row without a pivot. Generate two more vectors and add them to the list using the code above, to get seven vectors.

```
>> A = [ A v]
```

```
A =
     3     4    -5    -3     8    -5    -4
     5     5    -1    -7     0    -8     8
    10     3     5     0     0     9     1
    -3    -9     0     8    -4    -9    -1
    -5     3    -5     8    10     0     9
    10     8    -5    -9     0     -2    -9
```

```
>> rref(A)
```

```
ans =
    1.0000         0         0         0         0         0    -1.0064
         0    1.0000         0         0         0         0     2.9989
         0         0    1.0000         0         0         0     2.6820
         0         0         0    1.0000         0         0     1.3376
         0         0         0         0    1.0000         0    -0.2319
         0         0         0         0         0         0    1.0000    -1.2603
```

This set is not linearly independent because there is a column without a pivot in it.

- (b) Assume that A is a matrix whose columns represent matrices that form a basis for M_{nm} . A matrix in M_{nm} will be represented by a vector in \mathbb{R}^{nm} , so there are nm rows in A . As in problem 3 above, since the columns are linearly independent, and the span, A has the same number of rows as columns. But the number of columns of A is the same as the number of matrices in the basis, so there are nm matrices in a basis of M_{nm} .
5. (a) Refer to the answers to Problem 1 in this section and Problem 2 in MATLAB 1.8. In each case, the matrix reduces to the identity matrix, so each matrix is invertible, and the columns form a basis for \mathbb{R}^n .
- (b) The columns of a matrix form a basis for \mathbb{R}^n if and only if the matrix is an invertible $n \times n$ matrix.
- (c) The columns form a basis if and only if the matrix reduces to the identity matrix, when put in row echelon form. The matrix reduces to the identity matrix if and only if it is invertible.

6. (a) (i) Since $\{\mathbf{v}_1, \dots, \mathbf{v}_5\}$ form a basis, there is always a unique solution to $\mathbf{w} = c_1\mathbf{v}_1 + \dots + c_5\mathbf{v}_5$.
 (ii) Using the distributive rules for matrix multiplication

$$A\mathbf{w} = A(c_1\mathbf{v}_1 + \dots + c_5\mathbf{v}_5) = c_1A\mathbf{v}_1 + \dots + c_5A\mathbf{v}_5 = c_1\mathbf{w}_1 + \dots + c_5\mathbf{w}_5.$$

- (iii) From the previous formula,

$$A\mathbf{w} = c_1\mathbf{w}_1 + \dots + c_5\mathbf{w}_5 = [\mathbf{w}_1 \ \mathbf{w}_2 \ \mathbf{w}_3 \ \mathbf{w}_4 \ \mathbf{w}_5] \begin{pmatrix} c_1 \\ c_2 \\ c_3 \\ c_4 \\ c_5 \end{pmatrix}.$$

- (b) Call $W = [\mathbf{w}_1 \ \mathbf{w}_2 \ \mathbf{w}_3 \ \mathbf{w}_4 \ \mathbf{w}_5]$. We wish to find $\mathbf{y} = A\mathbf{w}$ for the given \mathbf{w} . From part (a), we know that $\mathbf{y} = W\mathbf{c}$ where \mathbf{c} are the coefficients of \mathbf{w} in the basis $\{\mathbf{v}_1, \dots, \mathbf{v}_5\}$. If V is the matrix of these vectors, then $V\mathbf{c} = \mathbf{w}$. So to find \mathbf{c} , we need to solve $V\mathbf{c} = \mathbf{w}$ for \mathbf{c} .

```
>> W = [ 5 7 36 -10 5; 5 5 25 -2 9; 3 7 13 -1 5];
>>                                     % The basis from 1(ii) is:
>> V = [1 1 2 -1 1; -1 0 4 -1 1; 0 3 -1 2 1; 2 -1 3 -1 1; 1 1 1 1 1];
```

(i)

```
>> w = [ 0; -10; 9; -6; -4];
>> c = V \ w                               % Solve Vc = w.

c =
    -8
   -10
   -18
   -11
    43

>> y = W*c                               % Find y = Aw using part (a).
y =
  -433
  -131
  -102
```

(ii)

```
>> w = 2*rand(5,1) - 1
w =
   -0.5621
   -0.9059
    0.3577
    0.3586
    0.8694

>> c = V \ w                               % Solve Vc = w.
c =
    0.6897
    0.1912
    0.6134
    1.0224
   -1.6475
```



```
>> y = W*c                                % Find y = Aw using part (a).
y =
    8.4090
    2.8686
    2.1227
```

(c) The only thing that needs to be changed is the matrix W in (b).

```
>> W = eye(5);                            % The matrix W happens to be the identity.
```

(i)

```
>> w = [ 0; -10; 9; -6; -4];
>> c = V\w                                % Solve Vc = w.
c =
   -8
  -10
  -18
  -11
   43
```

```
>> y = W*c                                % Find y = Aw using part (a).
y =
   -8
  -10
  -18
  -11
   43
```

(ii)

```
>> w = 2*rand(5,1) -1
w =
   -0.2330
    0.0388
    0.6619
   -0.9309
   -0.8931

>> c = V\w                                % Solve Vc = w.
c =
   -1.6729
   -1.6747
   -2.3744
   -1.5172
    6.3462

>> y = W*c                                % Find y = Aw using part (a).
y =
   -1.6729
   -1.6747
   -2.3744
   -1.5172
    6.3462
```

Section 4.7

For 1–15 we use $\rho = \#$ pivots in echelon form, $\nu = \#$ columns $-\rho$. We could also use $\nu =$ arbitrary variables in solutions to $A\mathbf{x} = 0$.

1. $\begin{vmatrix} 1 & 2 \\ 3 & 4 \end{vmatrix} = -2 \neq 0 \Rightarrow \rho = 2; \nu = 2 - 2 = 0$
2. $\begin{pmatrix} 1 & -1 & 2 \\ 3 & 1 & 0 \end{pmatrix} \rightarrow \begin{pmatrix} 1 & -1 & 2 \\ 0 & 4 & -6 \end{pmatrix} \Rightarrow \rho = 2; \nu = 3 - 2 = 1$, since 2 pivots.
3. $\begin{pmatrix} -1 & 3 & 2 \\ 2 & -6 & -4 \end{pmatrix} \rightarrow \begin{pmatrix} -1 & 3 & 2 \\ 0 & 0 & 0 \end{pmatrix} \Rightarrow \rho = 1; \nu = 3 - 1 = 2$, since 1 pivot.
4. $\begin{vmatrix} 1 & -1 & 2 \\ 3 & 1 & 4 \\ -1 & 0 & 4 \end{vmatrix} = 22 \neq 0 \Rightarrow \rho = 3; \nu = 3 - 3 = 0$
5. $\begin{pmatrix} 1 & -1 & 2 \\ 3 & 1 & 4 \\ 5 & -1 & 8 \end{pmatrix} \rightarrow \begin{pmatrix} 1 & -1 & 2 \\ 0 & 4 & -2 \\ 0 & 4 & -2 \end{pmatrix} \Rightarrow \rho = 2; \nu = 3 - 2 = 1$.
6. $\begin{pmatrix} -1 & 2 & 1 \\ 2 & -4 & -2 \\ -3 & 6 & 3 \end{pmatrix} \rightarrow \begin{pmatrix} -1 & 2 & 1 \\ 0 & 0 & 0 \\ 0 & 0 & 0 \end{pmatrix} \Rightarrow \rho = 1; \nu = 3 - 1 = 2$
7. $\begin{pmatrix} 1 & -1 & 2 & 3 \\ 0 & 1 & 4 & 3 \\ 1 & 0 & 6 & 6 \end{pmatrix} \rightarrow \begin{pmatrix} 1 & -1 & 2 & 3 \\ 0 & 1 & 4 & 3 \\ 0 & 1 & 4 & 3 \end{pmatrix} \Rightarrow \rho = 2; \nu = 4 - 2 = 2$
8. $\begin{pmatrix} 1 & -1 & 2 & 3 \\ 0 & 1 & 4 & 3 \\ 1 & 0 & 6 & 5 \end{pmatrix} \rightarrow \begin{pmatrix} 1 & -1 & 2 & 3 \\ 0 & 1 & 4 & 3 \\ 0 & 1 & 4 & 2 \end{pmatrix} \Rightarrow \rho = 3; \nu = 4 - 3 = 1$
9. $\begin{pmatrix} 2 & 3 \\ -1 & 1 \\ 4 & 7 \end{pmatrix} \rightarrow \begin{pmatrix} 2 & 3 \\ 0 & 5/2 \\ 0 & 1 \end{pmatrix} \rightarrow \begin{pmatrix} 2 & 3 \\ 0 & 5/2 \\ 0 & 0 \end{pmatrix} \Rightarrow \rho = 2; \nu = 2 - 2 = 0$
10. $\begin{vmatrix} 1 & -1 & 2 & 3 \\ 0 & 1 & 0 & 1 \\ 1 & 0 & 1 & 0 \\ 0 & 0 & 0 & 1 \end{vmatrix} = -1 \neq 0 \Rightarrow \rho = 4; \nu = 4 - 4 = 0$
11. $\begin{pmatrix} 1 & -1 & 2 & 1 \\ -1 & 0 & 1 & 2 \\ 1 & -2 & 5 & 4 \\ 2 & -1 & 1 & -1 \end{pmatrix} \rightarrow \begin{pmatrix} 1 & -1 & 2 & 3 \\ 0 & -1 & 3 & 3 \\ 0 & 1 & -3 & -3 \\ 0 & -1 & 3 & 3 \end{pmatrix} \rightarrow \begin{pmatrix} 1 & -1 & 2 & 1 \\ 0 & -1 & 3 & 3 \\ 0 & 0 & 0 & 0 \\ 0 & 0 & 0 & 0 \end{pmatrix} \Rightarrow \rho = 2; \nu = 4 - 2 = 2$
12. $\begin{pmatrix} 1 & -1 & 2 & 3 \\ -2 & 2 & -4 & -6 \\ 2 & -2 & 4 & 6 \\ 3 & -3 & 6 & 9 \end{pmatrix} \rightarrow \begin{pmatrix} 1 & -1 & 2 & 3 \\ 0 & 0 & 0 & 0 \\ 0 & 0 & 0 & 0 \\ 0 & 0 & 0 & 0 \end{pmatrix} \Rightarrow \rho = 1; \nu = 4 - 1 = 3$
13. $\begin{pmatrix} -1 & -1 & 0 & 0 \\ 0 & 0 & 2 & 3 \\ 4 & 0 & -2 & 1 \\ 3 & -1 & 0 & 4 \end{pmatrix} \rightarrow \begin{pmatrix} -1 & -1 & 0 & 0 \\ 0 & 0 & 2 & 3 \\ 0 & -4 & -2 & 1 \\ 0 & -4 & 0 & 4 \end{pmatrix} \rightarrow \begin{pmatrix} -1 & -1 & 0 & 0 \\ 0 & -4 & -2 & 1 \\ 0 & 0 & 2 & 3 \\ 0 & 0 & -2 & -3 \end{pmatrix} \rightarrow \begin{pmatrix} -1 & -1 & 0 & 0 \\ 0 & -4 & -2 & 1 \\ 0 & 0 & 2 & 3 \\ 0 & 0 & 0 & 0 \end{pmatrix} \Rightarrow \rho = 3; \nu = 4 - 3 = 1$

14. $\rho = 2; \nu = 3 - 2 = 1$

15. $\begin{pmatrix} 1 & 2 & 3 \\ 0 & 0 & 4 \\ 0 & 0 & 6 \end{pmatrix} \rightarrow \begin{pmatrix} 1 & 2 & 3 \\ 0 & 0 & 4 \\ 0 & 0 & 0 \end{pmatrix} \Rightarrow \rho = 2; \nu = 3 - 2 = 1$

For 16–21 choose basis for Range A as columns of A with pivots in echelon form or transposes of non-zero rows in echelon form of A^t .

16. Basis for Range $A = \left\{ \begin{pmatrix} 1 \\ 3 \end{pmatrix}, \begin{pmatrix} -1 \\ 1 \end{pmatrix} \right\}; \begin{pmatrix} 1 & -1 & 2 & | & 0 \\ 3 & 1 & 0 & | & 0 \end{pmatrix} \rightarrow \begin{pmatrix} 1 & -1 & 2 & | & 0 \\ 0 & 4 & -6 & | & 0 \end{pmatrix} \rightarrow \begin{pmatrix} 1 & 0 & 1/2 & | & 0 \\ 0 & 1 & -3/2 & | & 0 \end{pmatrix};$ Basis for $N_A = \left\{ \begin{pmatrix} -1/2 \\ 3/2 \\ 1 \end{pmatrix} \right\}$

17. $A^t = \begin{pmatrix} 1 & 3 & 5 \\ -1 & 1 & -1 \\ 2 & 4 & 8 \end{pmatrix} \rightarrow \begin{pmatrix} 1 & 3 & 5 \\ 0 & 4 & 4 \\ 0 & -2 & -2 \end{pmatrix} \rightarrow \begin{pmatrix} 1 & 3 & 5 \\ 0 & 4 & 4 \\ 0 & 0 & 0 \end{pmatrix};$ Basis for Range $A = \left\{ \begin{pmatrix} 1 \\ 3 \\ 5 \end{pmatrix}, \begin{pmatrix} 0 \\ 1 \\ 1 \end{pmatrix} \right\}$
 $\begin{pmatrix} 1 & -1 & 2 & | & 0 \\ 3 & 1 & 4 & | & 0 \\ 5 & -1 & 8 & | & 0 \end{pmatrix} \rightarrow \begin{pmatrix} 1 & -1 & 2 & | & 0 \\ 0 & 4 & -2 & | & 0 \\ 0 & 0 & 0 & | & 0 \end{pmatrix} \rightarrow \begin{pmatrix} 1 & 0 & 3/2 & | & 0 \\ 0 & 1 & -1/2 & | & 0 \\ 0 & 0 & 0 & | & 0 \end{pmatrix};$ Basis for $N_A = \left\{ \begin{pmatrix} -3/2 \\ 1/2 \\ 1 \end{pmatrix} \right\}$

18. Note that $c_2 = -2c_1$, and $c_3 = -c_1$, then Basis for Range $A = \left\{ \begin{pmatrix} -1 \\ 2 \\ -3 \end{pmatrix} \right\}$

$\begin{pmatrix} -1 & 2 & 1 & | & 0 \\ 2 & -2 & -4 & | & 0 \\ -3 & 6 & 3 & | & 0 \end{pmatrix} \rightarrow \begin{pmatrix} -1 & 2 & 1 & | & 0 \\ 0 & 0 & 0 & | & 0 \\ 0 & 0 & 0 & | & 0 \end{pmatrix} \Rightarrow x_1 = 2x_2 + x_3;$ Basis for $N_A = \left\{ \begin{pmatrix} 2 \\ 1 \\ 0 \end{pmatrix}, \begin{pmatrix} 0 \\ 1 \\ 1 \end{pmatrix} \right\}$

19. Note that the first, second and fourth columns of A are linearly independent. Basis for Range $A =$

$\left\{ \begin{pmatrix} 1 \\ 0 \\ 1 \end{pmatrix}, \begin{pmatrix} -1 \\ 1 \\ 0 \end{pmatrix}, \begin{pmatrix} 2 \\ 4 \\ 6 \end{pmatrix} \right\}.$

$\begin{pmatrix} 1 & -1 & 2 & 3 & | & 0 \\ 0 & 1 & 4 & 3 & | & 0 \\ 1 & 0 & 6 & 5 & | & 0 \end{pmatrix} \rightarrow \begin{pmatrix} 1 & -1 & 2 & 3 & | & 0 \\ 0 & 1 & 4 & 3 & | & 0 \\ 0 & 0 & 0 & 1 & | & 0 \end{pmatrix} \rightarrow \begin{pmatrix} 1 & 0 & 6 & 6 & | & 0 \\ 0 & 1 & 4 & 3 & | & 0 \\ 0 & 0 & 0 & 1 & | & 0 \end{pmatrix} \rightarrow \begin{pmatrix} 1 & 0 & 6 & 0 & | & 0 \\ 0 & 1 & 4 & 0 & | & 0 \\ 0 & 0 & 0 & 1 & | & 0 \end{pmatrix}$

Basis for $N_A = \left\{ \begin{pmatrix} -6 \\ -4 \\ 1 \\ 0 \end{pmatrix} \right\}.$

20. Note that by problem 11, $\dim C_A = 2$ and the first two columns of A are linearly independent. Basis

for Range $A = \left\{ \begin{pmatrix} 1 \\ -1 \\ 1 \\ 2 \end{pmatrix}, \begin{pmatrix} -1 \\ 0 \\ -2 \\ -1 \end{pmatrix} \right\}$

$\begin{pmatrix} 1 & -1 & 2 & 1 & | & 0 \\ -1 & 0 & 1 & 2 & | & 0 \\ 1 & -2 & 5 & 4 & | & 0 \\ 2 & -1 & 1 & -1 & | & 0 \end{pmatrix} \rightarrow \begin{pmatrix} 1 & -1 & 2 & 1 & | & 0 \\ 0 & 1 & -3 & -3 & | & 0 \\ 0 & 0 & 0 & 0 & | & 0 \\ 0 & 0 & 0 & 0 & | & 0 \end{pmatrix} \rightarrow \begin{pmatrix} 1 & 0 & -1 & -2 & | & 0 \\ 0 & 1 & -3 & -3 & | & 0 \\ 0 & 0 & 0 & 0 & | & 0 \\ 0 & 0 & 0 & 0 & | & 0 \end{pmatrix}$

Basis for $N_A = \left\{ \begin{pmatrix} 1 \\ 3 \\ 1 \\ 0 \end{pmatrix}, \begin{pmatrix} 2 \\ 3 \\ 0 \\ 1 \end{pmatrix} \right\}$

$$21. \left(\begin{array}{cccc|c} 1 & -1 & 2 & 3 & 0 \\ -2 & 2 & -4 & -6 & 0 \\ 2 & -2 & 4 & 6 & 0 \\ 3 & -3 & 6 & 9 & 0 \end{array} \right) \rightarrow \left(\begin{array}{cccc|c} 1 & -1 & 2 & 3 & 0 \\ 0 & 0 & 0 & 0 & 0 \\ 0 & 0 & 0 & 0 & 0 \\ 0 & 0 & 0 & 0 & 0 \end{array} \right). \text{Basis for Range } A = \left\{ \begin{pmatrix} 1 \\ -2 \\ 2 \\ 3 \end{pmatrix} \right\}$$

$$\text{Basis for } N_A = \left\{ \begin{pmatrix} 1 \\ 0 \\ 0 \\ 0 \end{pmatrix}, \begin{pmatrix} -2 \\ 0 \\ 1 \\ 0 \end{pmatrix}, \begin{pmatrix} -3 \\ 0 \\ 0 \\ 1 \end{pmatrix} \right\}, \text{ as } \begin{pmatrix} x_2 - 2x_3 - 3x_4 \\ x_2 \\ x_3 \\ x_4 \end{pmatrix} \text{ gives } N_A.$$

22. By problem 13, $\dim C_A = 3$. Note that the first three columns of A are linearly independent. Basis

$$\text{for Range } A = \left\{ \begin{pmatrix} -1 \\ 0 \\ 4 \\ 3 \end{pmatrix}, \begin{pmatrix} -1 \\ 0 \\ 0 \\ -1 \end{pmatrix}, \begin{pmatrix} 0 \\ 2 \\ -2 \\ 0 \end{pmatrix} \right\}. \text{Continuing the reduction in solution 13}$$

$$\left(\begin{array}{cccc|c} -1 & -1 & 0 & 0 & 0 \\ 0 & 0 & 2 & 3 & 0 \\ 4 & 0 & -2 & 1 & 0 \\ 3 & -1 & 0 & 4 & 0 \end{array} \right) \rightarrow \left(\begin{array}{cccc|c} 1 & 1 & 0 & 0 & 0 \\ 0 & -4 & -2 & 1 & 0 \\ 0 & 0 & 2 & 3 & 0 \\ 0 & 0 & 0 & 0 & 0 \end{array} \right) \rightarrow \left(\begin{array}{cccc|c} 1 & 0 & 0 & 1 & 0 \\ 0 & 1 & 0 & -1 & 0 \\ 0 & 0 & 1 & 3/2 & 0 \\ 0 & 0 & 0 & 0 & 0 \end{array} \right).$$

$$\text{Basis for } N_A = \left\{ \begin{pmatrix} -1 \\ 1 \\ -3/2 \\ 1 \end{pmatrix} \right\}$$

$$23. \left(\begin{array}{ccc} 1 & 4 & -2 \\ 2 & 1 & 2 \\ -1 & 3 & -4 \end{array} \right) \rightarrow \left(\begin{array}{ccc} 1 & 4 & -2 \\ 0 & -7 & 6 \\ 0 & 7 & -6 \end{array} \right) \rightarrow \left(\begin{array}{ccc} 1 & 4 & -2 \\ 0 & -7 & 6 \\ 0 & 0 & 0 \end{array} \right) \quad \text{Basis: } \left\{ \begin{pmatrix} 1 \\ 4 \\ -2 \end{pmatrix}, \begin{pmatrix} 0 \\ -7 \\ 6 \end{pmatrix} \right\}$$

$$24. \left(\begin{array}{ccc} 1 & -2 & 3 \\ 2 & -1 & 4 \\ 3 & -3 & 3 \\ 2 & 1 & 0 \end{array} \right) \rightarrow \left(\begin{array}{ccc} 1 & -2 & 3 \\ 0 & 3 & 2 \\ 0 & 3 & -6 \\ 0 & 5 & -6 \end{array} \right) \rightarrow \left(\begin{array}{ccc} 1 & -2 & 3 \\ 0 & 3 & 2 \\ 0 & 0 & 8 \\ 0 & 0 & 0 \end{array} \right) \quad \text{Basis: } \left\{ \begin{pmatrix} 1 \\ -2 \\ 3 \end{pmatrix}, \begin{pmatrix} 0 \\ 3 \\ 2 \end{pmatrix}, \begin{pmatrix} 0 \\ 0 \\ 3 \end{pmatrix} \right\}$$

$$25. \left(\begin{array}{cccc} 1 & -1 & 1 & -1 \\ 2 & 0 & 0 & 1 \\ 4 & -2 & 2 & 1 \\ 7 & -3 & 3 & -1 \end{array} \right) \rightarrow \left(\begin{array}{cccc} 1 & -1 & 1 & -1 \\ 0 & 2 & -2 & 3 \\ 0 & 2 & -2 & 5 \\ 0 & 4 & -4 & 6 \end{array} \right) \rightarrow \left(\begin{array}{cccc} 1 & -1 & 1 & -1 \\ 0 & 2 & -2 & 3 \\ 0 & 0 & 0 & 2 \\ 0 & 0 & 0 & 0 \end{array} \right) \quad \text{Basis: } \left\{ \begin{pmatrix} 1 \\ -1 \\ 1 \\ -1 \end{pmatrix}, \begin{pmatrix} 0 \\ 2 \\ -2 \\ 3 \end{pmatrix}, \begin{pmatrix} 0 \\ 0 \\ 2 \\ 0 \end{pmatrix} \right\}$$

$$26. \left(\begin{array}{ccc} 1 & 0 & 0 & 1 \\ 0 & 1 & 1 & 0 \\ 1 & -2 & -2 & 1 \\ 0 & 2 & 2 & 1 \end{array} \right) \rightarrow \left(\begin{array}{ccc} 1 & 0 & 0 & 1 \\ 0 & 1 & 1 & 0 \\ 0 & 2 & 2 & 0 \\ 0 & 2 & 2 & 1 \end{array} \right) \rightarrow \left(\begin{array}{ccc} 1 & 0 & 0 & 1 \\ 0 & 1 & 1 & 0 \\ 0 & 0 & 0 & 0 \\ 0 & 0 & 0 & 1 \end{array} \right) \quad \text{Basis: } \left\{ \begin{pmatrix} 1 \\ 0 \\ 0 \\ 1 \end{pmatrix}, \begin{pmatrix} 0 \\ 1 \\ 1 \\ 0 \end{pmatrix}, \begin{pmatrix} 0 \\ 0 \\ 0 \\ 1 \end{pmatrix} \right\}$$

$$27. \left(\begin{array}{ccc|c} 1 & 1 & -1 & 7 \\ 4 & -1 & 5 & 4 \\ 6 & 1 & 3 & 20 \end{array} \right) \rightarrow \left(\begin{array}{ccc|c} 1 & 1 & -1 & 7 \\ 0 & -5 & 9 & -24 \\ 0 & -5 & 9 & -22 \end{array} \right) \rightarrow \left(\begin{array}{ccc|c} 1 & 1 & -1 & 7 \\ 0 & -5 & 9 & -24 \\ 0 & 0 & 0 & 2 \end{array} \right) \quad \rho(A) = 2 \neq 3 = \rho((A, \mathbf{b})) \Rightarrow \text{No solution.}$$

$$28. \left(\begin{array}{ccc|c} 1 & 1 & -1 & 7 \\ 4 & -1 & 5 & 4 \\ 6 & 1 & 3 & 18 \end{array} \right) \rightarrow \left(\begin{array}{ccc|c} 1 & 1 & -1 & 7 \\ 0 & -5 & 9 & -24 \\ 0 & 0 & 0 & 0 \end{array} \right) \quad \rho(A) = 2 = \rho((A, \mathbf{b})) \Rightarrow \text{Solution exists.}$$

$$29. \left(\begin{array}{cccc|c} 1 & -2 & 1 & 1 & 2 \\ 3 & 0 & 2 & -2 & -8 \\ 0 & 4 & -1 & -1 & 1 \\ 5 & 0 & 3 & -1 & -3 \end{array} \right) \rightarrow \left(\begin{array}{cccc|c} 1 & -2 & 1 & 1 & 2 \\ 0 & 6 & -1 & -5 & -14 \\ 0 & 4 & -1 & -1 & 1 \\ 0 & 10 & -2 & -6 & -13 \end{array} \right) \rightarrow \left(\begin{array}{cccc|c} 1 & -2 & 1 & 1 & 2 \\ 0 & 6 & -1 & -5 & -14 \\ 0 & 0 & 1 & -7 & -31 \\ 0 & 0 & 1 & -7 & -31 \end{array} \right) \quad \rho(A) = 3 = \rho((A, \mathbf{b})) \Rightarrow$$

Solution exists.

$$30. \left(\begin{array}{cccc|c} 1 & -2 & 1 & 1 & 2 \\ 3 & 0 & 2 & -2 & -8 \\ 0 & 4 & -1 & -1 & 1 \\ 5 & 0 & 3 & -1 & 0 \end{array} \right) \rightarrow \left(\begin{array}{cccc|c} 1 & -2 & 1 & 1 & 2 \\ 0 & 6 & -1 & -5 & -14 \\ 0 & 4 & -1 & -1 & 1 \\ 0 & 10 & -2 & -6 & -12 \end{array} \right) \rightarrow \left(\begin{array}{cccc|c} 1 & -2 & 1 & 1 & 2 \\ 0 & 6 & -1 & -5 & -14 \\ 0 & 0 & 1 & -7 & -31 \\ 0 & 0 & 1 & -7 & -34 \end{array} \right) \quad \rho(A) = 3 \neq 4 = \rho((A, \mathbf{b})) \Rightarrow \text{No solution.}$$

31. Since A is a diagonal matrix, the nonzero columns are linearly independent. Then the number of nonzero components on the diagonal is equal to the number of linearly independent columns of A , which is the rank of A .
32. Since A is an upper triangular square matrix with zeros on the diagonal, bottom row is all zeros, so less than n -pivots in echelon form. Thus $\rho(A) < n$.
33. $\rho(A) = \dim C_A = \dim R_A = \dim C_{A^t} = \rho(A^t)$.
34. (a) $\rho(A) = \dim R_A \leq m = \text{number of rows}$
 (b) $\nu(A) = n - \rho(A) \geq n - m$
35. Let $\{\mathbf{v}_1, \mathbf{v}_2, \dots, \mathbf{v}_k\}$ be a basis for Range A . Since B is invertible, $\{B\mathbf{v}_1, B\mathbf{v}_2, \dots, B\mathbf{v}_k\}$ is a linearly independent set in \mathbb{R}^m and thus is a basis for BA . Then $\rho(A) = \rho(BA)$. Since C is invertible, Range $C = \mathbb{R}^n$. Then if $\mathbf{v} \in \text{Range } A$, there is an $\mathbf{x} \in \mathbb{R}^n$ such that $A\mathbf{x} = \mathbf{v}$. But there also exists $\mathbf{y} \in \mathbb{R}^n$ such that $C\mathbf{y} = \mathbf{x}$. Then $AC\mathbf{y} = \mathbf{v}$. Then Range $A \subset \text{Range } AC$. If $\mathbf{v} \in \text{Range } AC$, there is an $\mathbf{x} \in \mathbb{R}^n$ such that $AC\mathbf{x} = \mathbf{v}$. But then $\mathbf{v} \in \text{Range } A$. So Range $AC \subset \text{Range } A$. Thus Range $AC = \text{Range } A$. Thus $\rho(A) = \rho(AC)$.
36. Suppose $\mathbf{b} \in C_{AB}$. Then $AB\mathbf{x} = \mathbf{b}$ for some \mathbf{x} . Then $\mathbf{b} \in C_A$ because $A\mathbf{y} = \mathbf{b}$ for $\mathbf{y} = B\mathbf{x}$. Then $C_{AB} \subseteq C_A$. Thus $\rho(AB) \leq \rho(A)$. Next, note that the i^{th} row of AB is a combination of the rows of B . Then $R_{AB} \subseteq R_B$. Thus $\rho(AB) \leq \rho(B)$. Thus $\rho(AB) \leq \min(\rho(A), \rho(B))$.
37. Since $\rho(A) = 5$, $\rho(A, \mathbf{b}) = 5$ for any 5-vector \mathbf{b} . Then, by Theorem 7, $A\mathbf{x} = \mathbf{b}$ has at least one solution for every 5-vector \mathbf{b} .
38. Let M_1, \dots, M_r be the matrices which represent the elementary row operations which would convert A to the reduced echelon form E_1 . That is, $M_r \cdots M_1 A = E_1$. Let N_1, \dots, N_s be the matrices which represent the elementary row operations which would convert B to the reduced echelon form E_2 . Then $N_s \cdots N_1 B = E_2$. Note that $M_1, \dots, M_r, N_1, \dots, N_s$ are all invertible matrices. Since $\rho(A) = \rho(B)$, the number of nonzero pivot elements of E_1 equals the number of nonzero pivot elements of E_2 , and thus the first $\rho(A)$ rows of each E_i have pivot columns with leading 1. Now elementary column operations on E_1, E_2 will bring both into the same form with k -ones on the diagonals of pivot rows and zeros elsewhere. Column operations are right multiplication by elementary matrices. Thus $M_r, \dots, M_1 A C_1 \cdots C_l = N_s \cdots N_1 B D_1 \cdots D_k$ or $(N_1^{-1} \cdots N_s^{-1} M_r \cdots M_1) A (C_1 \cdots C_l D_k^{-1} \cdots D_1^{-1}) = B$.
39. This follows from problem 35.
40. Since any $k + 1$ rows of A are linearly dependent, $\rho(A) \leq k$. Since any k rows of A are linearly independent, $\rho(A) \geq k$. Thus $\rho(A) = k$.
41. Suppose $\rho(A) < n$. If $A\mathbf{x} = \mathbf{0}$ has only $\mathbf{x} = \mathbf{0}$ as a solution, then by Theorem 8, $\rho(A) = n$. This is a contradiction, so there must exist $\mathbf{x} \neq \mathbf{0}$ such that $A\mathbf{x} = \mathbf{0}$. Suppose there exists $\mathbf{x} \neq \mathbf{0}$ such that $A\mathbf{x} = \mathbf{0}$. If $\rho(A) = n$, then, by Theorem 8, $\mathbf{x} = \mathbf{0}$ is the only solution to $A\mathbf{x} = \mathbf{0}$. This is a contradiction, so $\rho(A) < n$.
42. Hypotheses mean Range $A = \mathbb{R}^m$. Then $\dim \text{Range } A = m = \rho(A)$.

43. Suppose that B , the row echelon form of A , has k pivots in its first k rows. Since there are no other pivots, all the entries below the first k rows are zero. Let $b_{1,m_1}, b_{2,m_2}, \dots, b_{k,m_k}$ denote the pivots; let $\mathbf{r}_1, \mathbf{r}_2, \dots, \mathbf{r}_k$ denote the first k rows of B and suppose that $c_1\mathbf{r}_1 + c_2\mathbf{r}_2 + \dots + c_k\mathbf{r}_k = \mathbf{0}$. By the definition of a pivot, the m_1 component in the vector $\mathbf{0} = c_1\mathbf{r}_1 + \dots + c_k\mathbf{r}_k$ is c_1b_{1,m_1} . Since $b_{1,m_1} \neq 0$, we conclude that $c_1 = 0$. The m_2 component of the vector is $c_1b_{1,m_2} + c_2b_{2,m_2}$. Since $c_1 = 0$ and $b_{2,m_2} \neq 0$, we conclude that $c_2 = 0$. Continuing in this manner, we see that $c_j = 0$ for $j = 1, 2, \dots, k$ so the first k rows of B are linearly independent. Since all other rows in the row echelon form of A are zero, we conclude that $\rho(A) = \dim R_A = k$, as $\mathbf{r}_1, \dots, \mathbf{r}_k$ are a basis for R_A .

Now, suppose that $\rho(A) = k$. Let B equal the row echelon form of A . As above, the first k rows of B are linearly independent and all entries below the first k rows are zero. The first nonzero entry in each of the first k rows of B is a pivot, for if not, it would have been made zero by the row reduction of A to its row echelon form. Thus B has k pivots.

CALCULATOR SOLUTIONS 4.7

The problems in this section ask you to compute the rank, range, row space and nullity of the given matrices. As usual, our solutions for the TI-85 assume the matrix is in $A47nn$. Then we compute $\text{rref } Ann$ and read off the solutions from the reduced row echelon form and the original matrix as follows:

The **nullity** of A ($\nu(A)$) is the number of non-pivot columns in $\text{rref } A$. This follows from the fact that the description of the nullspace obtained from $\text{rref } A$ shows that each non-pivot column contributes one vector to a basis of the nullspace by setting that non-pivot column variable to 1 and all other non-pivot variables to 0. So $\dim(N_A) = \text{number of non-pivot columns}$.

A basis for the **Range** of A ($= C_A$ - the column space of A) is given by the columns of A corresponding to the *pivots* in $\text{rref } A$. (This follows from the fact that the each vector in the basis for the *nullspace* described above shows how to write each non-pivot column vector from the original A as a linear combination of the pivot columns of the original A . This shows the non-pivot columns are redundant and the pivot columns span C_A . The pivot columns are independent since any linear combination of columns equal to $\mathbf{0}$ with zero coefficients in the non-pivot columns also must have zeros in the pivot columns from the description of N_A in terms of $\text{rref } A$).

The **rank** of A ($\rho(A)$ or $\dim(C_A)$) is computed as the number of pivots in $\text{rref } A$, since each pivot contributes one column of the original matrix to the basis for C_A described above. (Alternatively you could use $\rho(A) + \nu(A) = \text{\# of columns of } A$.)

A basis for the **row space** of A (R_A) is given by the non-zero rows in $\text{rref } A$, since those rows are independent (look at the pivot columns in those rows) and span the space $R_A (= R_{\text{rref}(A)})$ by Theorem 5).

44. For A4744:
$$\begin{bmatrix} .37 & .48 & -.7 & -1.16 \\ .46 & -.39 & 2.09 & .83 \\ .52 & .87 & -1.57 & 1.04 \\ .67 & .35 & .29 & -.33 \end{bmatrix} \text{rref A4744 } \boxed{\text{ENTER}}$$
- yields:
$$\begin{bmatrix} 1 & 0 & 2 & 0 \\ 0 & 1 & -3 & 0 \\ 0 & 0 & 0 & 1 \\ 0 & 0 & 0 & 0 \end{bmatrix}$$
 . So $\rho(A4744) = 3$, since there are 3 pivot columns and the C_{A4744} has a basis:
- $$\left\{ \begin{pmatrix} .37 \\ .46 \\ .52 \\ .67 \end{pmatrix}, \begin{pmatrix} .48 \\ -.39 \\ .87 \\ .35 \end{pmatrix}, \begin{pmatrix} -1.16 \\ .83 \\ 1.04 \\ -.33 \end{pmatrix} \right\}$$
 chosen as the columns of A4744 corresponding to pivots in the reduced echelon form. R_{A4744} has the first three (non-zero) rows of $\text{rref } A4744$ as a basis: $\{ [1 \ 0 \ 2 \ 0], [0 \ 1 \ -3 \ 0], [0 \ 0 \ 0 \ 1] \}$. Finally, $\nu(A4744) = 4 - \rho(A4744) = 1$ (which also is the number of non-pivot columns in A4744).

45. For A4745 =
$$\begin{bmatrix} 187 & -46 & 512 & 653 & 512 \\ -35 & 51 & -233 & -207 & -325 \\ 257 & -148 & 958 & 1067 & 1162 \end{bmatrix}$$
, $\text{rref } A4745 \boxed{\text{ENTER}}$ yields:
- $$\begin{bmatrix} 1 & 0 & 2 & 3 & 1.40809890249 \\ 0 & 1 & -3 & -2 & -5.40620663555 \\ 0 & 0 & 0 & 0 & 0 \end{bmatrix}$$
 . So rank of A4745 ($\rho(A4745)$) is 2, since there are 2 pivot
- columns and the range of A4745 (C_{A4745}) has a basis:
$$\left\{ \begin{pmatrix} 187 \\ 35 \\ 257 \end{pmatrix}, \begin{pmatrix} -46 \\ 51 \\ -148 \end{pmatrix} \right\}$$
 chosen as the columns of A4745 cor-

responding to pivots in the reduced echelon form. R_{A4745} has the non-zero rows of $\text{rref } A4745$ as a basis: $\{ [1 \ 0 \ 2 \ 3 \ 1.40809890249], [0 \ 1 \ -3 \ -2 \ -5.40620663555] \}$. Finally, $\nu(A4745) = 5 - \rho(A4745) = 3$ (which also is the number of non-pivot columns in $A4745$).

46. For $A4746 = \begin{bmatrix} 37 & 81 & -29 & 58 & 33 & -19 & 102 \\ -48 & 91 & 306 & 38 & 205 & 0 & -58 \\ 53 & 215 & -47 & -11 & -38 & 423 & 99 \\ -85 & 10 & 335 & -20 & 172 & 19 & -160 \\ -80 & 316 & 594 & 7 & 339 & 442 & -119 \\ -71 & 46 & -416 & -83 & 201 & -88 & 144 \end{bmatrix}$, $\text{rref } A4746$ yields:

$$\begin{bmatrix} 1 & 0 & 0 & 0 & -3.1038473473 & 2.93920187539 & -.151801945062 \\ 0 & 1 & 0 & 0 & .625586755864 & 1.18104420224 & .446191742079 \\ 0 & 0 & 1 & 0 & -.198695556927 & .553790907848 & -.469903022938 \\ 0 & 0 & 0 & 1 & 1.57599402542 & -3.57508816282 & .99737850334 \\ 0 & 0 & 0 & 0 & 0 & 0 & 0 \\ 0 & 0 & 0 & 0 & 0 & 0 & 0 \end{bmatrix}$$

So $\rho(A4746) = 4$, since there are 4 pivot columns and the C_{A4746} has a basis: $\left\{ \begin{pmatrix} 37 \\ -48 \\ 53 \\ -85 \\ -80 \\ -71 \end{pmatrix}, \begin{pmatrix} 81 \\ 91 \\ 215 \\ 10 \\ 316 \\ 46 \end{pmatrix}, \begin{pmatrix} -29 \\ 306 \\ -47 \\ 335 \\ 594 \\ -416 \end{pmatrix}, \begin{pmatrix} 58 \\ 38 \\ -11 \\ -20 \\ 7 \\ -83 \end{pmatrix} \right\}$

chosen as the columns of $A4746$ corresponding to pivots in the reduced echelon form. R_{A4746} has the four non-zero rows of $\text{rref } A4746$ as a basis. Finally, $\nu(A4746) = 7 - \rho(A4746) = 3$ (which also is the number of non-pivot columns in $A4746$).

47. For $A4747 = \begin{bmatrix} .0284 & -.0311 & -.0207 & .0431 & .0615 \\ -.0511 & -.1216 & -.1811 & .0904 & .031 \\ -.0965 & -.427 & -.5847 & .3574 & .216 \\ .0795 & .0905 & .1604 & -.473 & .0305 \\ -.011 & -.3365 & -.4243 & .3101 & .521 \end{bmatrix}$, $\text{rref } A4747$

yields:

$$\begin{bmatrix} 1 & 0 & 0 & 0 & 45.7500000001 \\ 0 & 1 & 0 & 0 & 87.7022036283 \\ 0 & 0 & 1 & 0 & -71.9680450647 \\ 0 & 0 & 0 & 1 & -1.68350168351E-12 \\ 0 & 0 & 0 & 0 & 0 \end{bmatrix}$$

So $\rho(A4747) = 4$, since there are 4 pivot columns and the C_{A4747} has a basis:

$\left\{ \begin{pmatrix} .0284 \\ -.0511 \\ -.0965 \\ .0795 \\ -.011 \end{pmatrix}, \begin{pmatrix} -.0311 \\ -.1216 \\ -.427 \\ .0905 \\ -.3365 \end{pmatrix}, \begin{pmatrix} -.0207 \\ -.1811 \\ -.5847 \\ .1604 \\ -.4243 \end{pmatrix}, \begin{pmatrix} .0431 \\ .0904 \\ .3574 \\ -.473 \\ .3101 \end{pmatrix} \right\}$ chosen as the columns of $A4747$ corresponding to pivots in the

reduced echelon form. R_{A4747} has the 4 non-zero rows of $\text{rref } A4747$ as a basis. Finally, $\nu(A4747) = 5 - \rho(A4747) = 1$ (which also is the number of non-pivot columns in $A4747$).

MATLAB 4.7

1.

(i) Problem 7.

```
>> A = [ 1 -1 2 3; 0 1 4 3; 1 0 6 6];
>> rref(A)
ans =
     1     0     6     6
     0     1     4     3
     0     0     0     0
```

(a) The solution of $Ax = 0$ is

$$\mathbf{x} = x_3 \begin{pmatrix} -6 \\ -4 \\ 1 \\ 0 \end{pmatrix} + x_4 \begin{pmatrix} -6 \\ -3 \\ 0 \\ 1 \end{pmatrix}.$$

So a basis of the null space of A is

$$\left\{ \begin{pmatrix} -6 \\ -4 \\ 1 \\ 0 \end{pmatrix}, \begin{pmatrix} -6 \\ -3 \\ 0 \\ 1 \end{pmatrix} \right\}.$$

(b) Let B be the matrix whose columns are these vectors. We use the reduced echelon form of B to check that they are linearly independent.

```
>> B = [ -6 -6; -4 -3; 1 0; 0 1];
>> rref(B)
ans =
     1     0
     0     1
     0     0
     0     0
```

(c) See below.

(d) The dimension is 2.

(ii) Problem 8.

```
>> A = [ 1 -1 2 3; 0 1 4 3; 1 0 6 5];
>> rref(A)
ans =
     1     0     6     0
     0     1     4     0
     0     0     0     1
```

(a) The solution of $Ax = 0$ is

$$\mathbf{x} = x_3 \begin{pmatrix} -6 \\ -4 \\ 1 \\ 0 \end{pmatrix}.$$

So a basis of the null space of A is

$$\left\{ \begin{pmatrix} -6 \\ -4 \\ 1 \\ 0 \end{pmatrix} \right\}.$$

(b) Let B be the matrix whose columns are these vectors. We use the reduced echelon form of B to check that they are linearly independent.

```
>> B = [ -6; -4; 1; 0];
>> rref(B)
ans =
     1
     0
     0
     0
```

(c) See below.

(d) The dimension is 1.

(iii) Problem 10.

```
>> A = [ 1 -1 2 3; 0 1 0 1; 1 0 1 0; 0 0 0 1];
>> rref(A)
ans =
     1     0     0     0
     0     1     0     0
     0     0     1     0
     0     0     0     1
```

(a) The solution of $Ax = 0$ is

$$\mathbf{x} = \begin{pmatrix} 0 \\ 0 \\ 0 \\ 0 \end{pmatrix}.$$

The basis is the empty set.

(b) The dimension is 0.

(iv) Problem 11.

```
>> A = [1 -1 2 1; -1 0 1 2; 1 -2 5 4; 2 -1 1 -1];
>> rref(A)
ans =
     1     0    -1    -2
     0     1    -3    -3
     0     0     0     0
     0     0     0     0
```

(a) The solution of $Ax = 0$ is

$$\mathbf{x} = x_3 \begin{pmatrix} 1 \\ 3 \\ 1 \\ 0 \end{pmatrix} + x_4 \begin{pmatrix} 2 \\ 3 \\ 0 \\ 1 \end{pmatrix}.$$

So a basis of the null space of A is

$$\left\{ \begin{pmatrix} 1 \\ 3 \\ 1 \\ 0 \end{pmatrix}, \begin{pmatrix} 2 \\ 3 \\ 0 \\ 1 \end{pmatrix} \right\}.$$

(b) Let B be the matrix whose columns are these vectors. We use the reduced echelon form of B to check that they are linearly independent.

```
>> B = [ 1 2; 3 3; 1 0; 0 1];
>> rref(B)
ans =
     1     0
     0     1
     0     0
     0     0
```

(c) See below.

(d) The dimension is 2.

(v) Problem 12.

```
>> A = [1 -1 2 3; -2 2 -4 -6; 2 -2 4 6; 3 -3 6 9];
>> rref(A)
ans =
     1    -1     2     3
     0     0     0     0
     0     0     0     0
     0     0     0     0
```

(a) The solution of $Ax = 0$ is

$$x = x_2 \begin{pmatrix} 1 \\ 1 \\ 0 \\ 0 \end{pmatrix} + x_3 \begin{pmatrix} -2 \\ 0 \\ 1 \\ 0 \end{pmatrix} + x_4 \begin{pmatrix} -3 \\ 0 \\ 0 \\ 1 \end{pmatrix}.$$

So a basis of the null space of A is

$$\left\{ \begin{pmatrix} 1 \\ 1 \\ 0 \\ 0 \end{pmatrix}, \begin{pmatrix} -2 \\ 0 \\ 1 \\ 0 \end{pmatrix}, \begin{pmatrix} -3 \\ 0 \\ 0 \\ 1 \end{pmatrix} \right\}.$$

(b) Let B be the matrix whose columns are these vectors. We use the reduced echelon form of B to check that they are linearly independent.

```
>> B = [ 1 -2 -3; 1 0 0 ; 0 1 0; 0 0 1];
>> rref(B)
ans =
     1     0     0
     0     1     0
     0     0     1
     0     0     0
```

- (c) See below.
 (d) The dimension is 3.
 (vi) Problem 13.

```
>> A = [-1 -1 0 0; 0 0 2 3; 4 0 -2 1; 3 -1 0 4];
>> rref(A)
ans =
    1.0000         0         0     1.0000
         0     1.0000         0    -1.0000
         0         0     1.0000     1.5000
         0         0         0         0
```

- (a) The solution of $Ax = 0$ is

$$\mathbf{x} = x_4 \begin{pmatrix} -1 \\ 1 \\ -1.5 \\ 1 \end{pmatrix}.$$

So a basis of the null space of A is

$$\left\{ \begin{pmatrix} -1 \\ 1 \\ -1.5 \\ 1 \end{pmatrix} \right\}.$$

- (b) Let B be the matrix whose columns are these vectors. We use the reduced echelon form of B to check that they are linearly independent.

```
>> B = [ -1 ; 1 ; -1.5 ; 1 ];
>> rref(B)
ans =
     1
     0
     0
     0
```

- (c) See below.
 (d) The dimension is 1.
 (vii)

```
>> A = [-6 -2 -18 -2 -10; -9 0 -18 4 -5; 4 7 29 2 13];
>> rref(A)
ans =
     1     0     2     0     1
     0     1     3     0     1
     0     0     0     1     1
```

- (a) The solution of $Ax = 0$ is

$$\mathbf{x} = x_3 \begin{pmatrix} -2 \\ -3 \\ 1 \\ 0 \\ 0 \end{pmatrix} + x_5 \begin{pmatrix} -1 \\ -1 \\ 0 \\ -1 \\ 1 \end{pmatrix}.$$

So a basis of the null space of A is

$$\left\{ \begin{pmatrix} -2 \\ -3 \\ 1 \\ 0 \\ 0 \end{pmatrix}, \begin{pmatrix} -1 \\ -1 \\ 0 \\ -1 \\ 1 \end{pmatrix} \right\}.$$

- (b) Let B be the matrix whose columns are these vectors. We use the reduced echelon form of B to check that they are linearly independent.

```
>> B = [ -2 -1; -3 -1; 1 0; 0 -1; 0 1];
>> rref(B)
ans =
     1     0
     0     1
     0     0
     0     0
     0     0
```

(c) See below.

(d) The dimension is 2.

- (c) Since we wrote the general solution of $Ax = 0$ as a linear combination of these vectors, where the coefficients in the combination were the arbitrary variables, the general solution of $Ax = 0$ is in the span of these vectors. Since any vector in the null space is a solution of $Ax = 0$, these vectors span the null space.

- (d) The dimension of a vector space is the number of vectors in its basis. In this case, that is the number of arbitrary variables in the solution to system $Ax = 0$.

2. (a) (i) See answer to Problem 1(vi) above.
(ii)

```
>> R = rref(A);
>> B = [ -R(1,4); -R(2,4); -R(3,4); 1]
B =
    -1.0000
     1.0000
    -1.5000
     1.0000
```

```
>> % Notice that B is the same as the answer in Problem 1(vi).
```

(iii)

```
>> A*B
ans =
     0
     0
     0
     0
```

$AB = 0$ since B is in the null space.

- (b) (i) See the answer to Problem 1(vii).

(ii)

```
>> R = rref(A);
>> B = [[ -R(1,3); -R(2,3); 1;0;0] [ -R(1,5); -R(2,5); 0; -R(3,5); 1]]
B =
    -2    -1
    -3    -1
     1     0
     0    -1
     0     1

>> % These were the same as the vectors in Problem 1(vii).
```

(iii)

```
>> A*B
ans =
     0     0
     0     0
     0     0
```

We expect $AB = 0$ since the columns of B are in the null space of A .

(c)

(i)

```
>> A = [-9 3 8 -5 -1; -5 0 -5 -5 -3; -7 0 8 8 9];
>> R = rref(A)
R =
    1.0000         0         0         0    -0.2800
         0    1.0000         0   -4.3333   -3.5200
         0         0    1.0000    1.0000    0.8800

>> B = [ [-R(1,4); -R(2,4); -R(3,4); 1;0] [-R(1,5); -R(2,5); -R(3,5); 0;1]]
B =
         0    0.2800
    4.3333    3.5200
   -1.0000   -0.8800
    1.0000         0
         0    1.0000

>> A*B                                     % This should be zero.
ans =
    1.0e-15 *
         0   -0.8882
         0         0
         0         0
```

(ii)

```
>> A = rand(4,6); A(:,4) = 1/3*A(:,2)-2/7*A(:,3)
A =
    0.2190    0.9347    0.0346    0.3017    0.6868    0.5269
    0.0470    0.3835    0.0535    0.1126    0.5890    0.0920
    0.6789    0.5194    0.5297    0.0218    0.9304    0.6539
    0.6793    0.8310    0.6711    0.0852    0.8462    0.4160
```

```

>> R = rref(A)
R =
    1.0000         0         0    0.0000         0    2.1212
         0    1.0000         0    0.3333         0    0.0484
         0         0    1.0000   -0.2857         0   -1.7284
         0         0         0         0    1.0000    0.1121

>> B = [ [-R(1,4); -R(2,4); -R(3,4); 1; 0; 0] ...
        [-R(1,6); -R(2,6); -R(3,6); 0; -R(4,6); 1] ]
B =
    0.0000   -2.1212
   -0.3333   -0.0484
    0.2857    1.7284
    1.0000         0
         0   -0.1121
         0    1.0000

>> A*B                                % This should be zero.
ans =
    1.0e-16 *
         0         0
         0   -0.1388
         0         0
   -0.2776    0.5551

```

3. (a) Refer to the answer to Problem 2.

(i) For 2(a)

```

>> A = [-1 -1 0 0; 0 0 2 3; 4 0 -2 1; 3 -1 0 4];
>> B = [ -1 ; 1 ; -1.5 ; 1 ];
>> N = null(A)
N =
   -0.4364
    0.4364
   -0.6547
    0.4364

```

(ii) There is 1 vector in both B and N . Every basis for a vector space has the same number of vectors.

(iii)

```

>> rref([B N])
ans =
    1.0000    0.4364
         0         0
         0         0
         0         0

>> rref([N B])
ans =
    1.0000    2.2913
         0         0
         0         0
         0         0

```

The system $[B \mid N]$ can be solved. This means that the vector in N can be written as a linear combination of the vectors in B . Similarly, the vector in B can be written in terms of N . This is expected to be true since the vector in B is in the null space of A , and so we should be able to write it as a linear combination of the vectors in the basis N . Similarly, the vector in N is also in the null space of A , so we should be able to write it as a linear combination of the vectors in the basis B .

(i) For (2b)

```
>> A = [-6 -2 -18 -2 -10; -9 0 -18 4 -5; 4 7 29 2 13];
>> B = [-2 -1; -3 -1; 1 0; 0 -1; 0 1];
>> N = null(A)
N =
-0.2161 -0.5252
-0.5734 -0.5624
 0.3573  0.0372
 0.4984 -0.4508
-0.4984  0.4508
```

(ii) There are 2 vectors in both B and N .

(iii)

```
>> rref([B N])
ans =
 1.0000         0    0.3573    0.0372
         0    1.0000   -0.4984    0.4508
         0         0         0         0
         0         0         0         0
         0         0         0         0

>> rref([N B])
ans =
 1.0000         0    2.5098   -0.2072
         0    1.0000    2.7750    1.9892
         0         0         0         0
         0         0         0         0
         0         0         0         0
```

As above, the system $[B \mid \mathbf{w}]$ can be solved where \mathbf{w} is any of the vectors in N . Similarly, B can be written in terms of N .

(i) For 2(c)

```
>> A = [-9 3 8 -5 -1; -5 0 -5 -5 -3; -7 0 8 8 9];
>> R = rref(A);
>> B = [ [-R(1,4); -R(2,4); -R(3,4); 1;0] [-R(1,5); -R(2,5); -R(3,5); 0;1]];
>> N = null(A)
N =
-0.0936  0.1921
 0.8026  0.5230
-0.1626 -0.1671
 0.4569 -0.4367
-0.3344  0.6862
```

(ii) There are 2 vectors in both B and N .

(iii)

```

>> rref([B N])
ans =
    1.0000         0    0.4569   -0.4367
         0    1.0000   -0.3344    0.6862
         0         0         0         0
         0         0         0         0
         0         0         0         0

>> rref([N B])
ans =
    1.0000         0    4.0976    2.6078
         0    1.0000    1.9969    2.7281
         0         0         0         0
         0         0         0         0
         0         0         0         0

```

As above, the system $[B \mid \mathbf{w}]$ can be solved where \mathbf{w} is any of the vectors in N . Similarly, B can be written in terms of N .

(b)

```

>> A = [ 1 -2 5 1 9; -3 6 6 3.56 3; 4.2 -8.4 -10 4 -1];
>> N = null(A)
N =
    0.7108    0.5868
   -0.0921    0.6243
    0.5118   -0.3784
    0.2372   -0.1754
   -0.4101    0.3032

>> R = rref(A)
R =
    1.0000   -2.0000         0         0    2.1822
         0         0    1.0000         0    1.2479
         0         0         0    1.0000    0.5784

>> B = [ [2;1;0;0;0] [-R(1,5);0; -R(2,5); -R(3,5); 1]]
B =
    2.0000   -2.1822
    1.0000         0
         0   -1.2479
         0   -0.5784
         0    1.0000

>> A*B
ans =
    1.0e-04 *
         0   -0.0869
         0    0.0781
         0   -0.2821

>> A*N
ans =
    1.0e-14 *
   -0.0444   -0.2220
   -0.1776   -0.0888
    0.2220    0.1554

```

Both AN and AB should be zero since the columns of B and N should form a basis for the null space of A . But due to round off error they are not exactly zero. However, as predicted in the problem statement, AN is much closer to zero than AB .

4. (a) Since the i th entry of $A\mathbf{x}$ is the inner product of \mathbf{x} with the i th row of A , $A\mathbf{x} = 0$ only if the inner product of \mathbf{x} with each row of A is zero. This means that \mathbf{x} is in the null space of A if and only if \mathbf{x} is orthogonal to each row of A . Since the two subspaces are the same, they will have the same bases.

For (b) through (d), we may use the `null` command to find a basis for the null space of A where A is the matrix whose rows are the given vectors. The basis is made from the columns of the matrix returned by `null`.

(b)

```
>> A = [ -1 2 3];
>> null(A)
ans =
    0.5345    0.8018
    0.7745   -0.3382
   -0.3382    0.4927
```

(c)

```
>> A = [ 2 -3 1; -1 0 1/2];
>> null(A)
ans =
    0.3841
    0.5121
    0.7682
```

This is a multiple of the cross product of $A(:,1)$ and $A(:,2)$.

(d)

```
>> A = [ 1 2 -3 1 2; 0 1 5 -1 1; -2 3 1 4 0];
>> null(A)
ans =
    0.7579   -0.3428
   -0.2876   -0.5899
    0.1849    0.0342
    0.5485    0.2625
   -0.0883    0.6814
```

5.

```
>> A = [0 8 -6 -5 4 -4; 9 2 4 -10 9 8; 5 7 -7 -2 -5 3; 1 -7 -8 -9 -6 -7];
>> b = [46 29 0 -15]';
>> x = [1 2 -1 0 4 -2]';
```

(a)

```
>> A*x                                % This should be b.
ans =
    46
    29
     0
   -15
```

(b)

```
>> B = null(A)           % B is the matrix requested.
B =
    0.1627   -0.7266
   -0.3718   -0.0389
   -0.6353   -0.2038
    0.4034   -0.3029
    0.4832   -0.0264
    0.1882    0.5802
```

(c)

```
>> % Generate a random vector in null(A), by taking a
>> % random combination of the columns of B.
>> w = B * (2*rand(2,1)-1)
w =
    0.7717
   -0.2701
   -0.3408
    0.5964
    0.4187
   -0.3558

>> z = x+w
z =
    1.7717
    1.7299
   -1.3408
    0.5964
    4.4187
   -2.3558

>> A*z           % This should be b.
ans =
    46.0000
    29.0000
     0.0000
   -15.0000
```

This should be repeated for another random w .

6.

(i) (a)

```
>> A = [ 1 -2 3; -2 4 -6; 1 0 1];
>> R = rref(A)
R =
     1     0     1
     0     1    -1
     0     0     0

>> C = R([1 2], :)
C =
     1     0     1
     0     1    -1
```

```
>> B = C'
B =
     1     0
     0     1
     1    -1
```

(b)

```
>> % Use rref(B) to check that the columns of B are linearly independent.
>> rref(B)
ans =
     1     0
     0     1
     0     0
```

(c)

```
>> % To check that each original vector is a linear combination
>> % of the vectors in B, we use rref to solve [B A(j,:)]' for each j.
>> rref( [ B A(1,:)'] )
ans =
     1     0     1
     0     1    -2
     0     0     0

>> rref( [ B A(2,:)'] )
ans =
     1     0    -2
     0     1     4
     0     0     0

>> rref( [ B A(3,:)'] )
ans =
     1     0     1
     0     1     0
     0     0     0
```

(ii) (a)

```
>> A = [ 1 -1 0 3 -1 4; 2 0 1 7 2 1/2; 3 5 1 4 1 5];
>> R = rref(A)
R =
 1.0000         0         0  2.0000 -1.0000  4.0833
         0  1.0000         0 -1.0000         0  0.0833
         0         0  1.0000  3.0000  4.0000 -7.6667

>> C = R([1:3], :)
C =
 1.0000         0         0  2.0000 -1.0000  4.0833
         0  1.0000         0 -1.0000         0  0.0833
         0         0  1.0000  3.0000  4.0000 -7.6667
```

(b)

```
>> B = C';
>> % Use rref(B) to check that the columns of B are linearly independent.
>> rref(B)
ans =
    1     0     0
    0     1     0
    0     0     1
    0     0     0
    0     0     0
    0     0     0
```

(c)

```
>> % To check that each original vector is a linear combination
>> % of the vectors in B, we use rref to solve [B A(j,:)]' ] for each j.
>> rref( [ B A(1,:)'] )
ans =
    1     0     0     1
    0     1     0    -1
    0     0     1     0
    0     0     0     0
    0     0     0     0
    0     0     0     0

>> rref( [ B A(2,:)'] )
ans =
    1     0     0     2
    0     1     0     0
    0     0     1     1
    0     0     0     0
    0     0     0     0
    0     0     0     0

>> rref( [ B A(3,:)'] )
ans =
    1     0     0     3
    0     1     0     5
    0     0     1     1
    0     0     0     0
    0     0     0     0
    0     0     0     0
```

(i) (a)

```
>> A = [ 1 2 -1 3 1; -1 0 1 2 0; ...
        5 4 -5 0 2; 1 2 3 -2 0; 6 8 -2 3 3];
>> R = rref(A)
R =
    1.0000         0         0   -3.2500   -0.2500
         0    1.0000         0    2.5000    0.5000
         0         0    1.0000   -1.2500   -0.2500
         0         0         0         0         0
         0         0         0         0         0
```

```
>> C = R([1:3],:)
C =
    1.0000         0         0   -3.2500   -0.2500
         0    1.0000         0    2.5000    0.5000
         0         0    1.0000   -1.2500   -0.2500
```

(b)

```
>> B = C';
>> % Use rref(B) to check that the columns of B are linearly independent.
>> rref(B)
ans =
     1     0     0
     0     1     0
     0     0     1
     0     0     0
     0     0     0
```

(c)

```
>> % To check that each original vector is a linear combination
>> % of the vectors in B, we use rref to solve [B A(j,:)]' for each j.
>> rref( [ B A(1,:)'])
ans =
     1     0     0     1
     0     1     0     2
     0     0     1    -1
     0     0     0     0
     0     0     0     0

>> rref( [ B A(2,:)'])
ans =
     1     0     0    -1
     0     1     0     0
     0     0     1     1
     0     0     0     0
     0     0     0     0

>> rref( [ B A(3,:)'])
ans =
     1     0     0     5
     0     1     0     4
     0     0     1    -5
     0     0     0     0
     0     0     0     0

>> rref( [ B A(4,:)'])
ans =
     1     0     0     1
     0     1     0     2
     0     0     1     3
     0     0     0     0
     0     0     0     0
```

```
>> rref( [ B A(5,:)'] )
ans =
     1     0     0     6
     0     1     0     8
     0     0     1    -2
     0     0     0     0
     0     0     0     0
```

For part (a), we expect the columns of B , which are the rows of C to be a basis for the span of the vectors by the argument in example 6. For part (b), since each column has a pivot, the vectors are linearly independent. For part (c), each of the systems $[B \ v]$ had a unique solution. The coefficients of the linear combination were the first three entries of the original vector. This is because the first three rows of B are e_1 , e_2 , and e_3 .

7. (a) Since the range of a matrix is the same as its column space, by theorem 3, we may follow example 6. The nonzero rows of $\text{rref}(A')$ form a basis for the row space of A^t . Taking transposes gives a basis for the range of A .

(b) From problem 7.

(i)

```
>> A = [1 -1 2 3; 0 1 4 3; 1 0 6 6];
>> R = rref(A')
R =
     1     0     1
     0     1     1
     0     0     0
     0     0     0

>> B = ( R([1:2], :) )'           % Turn the nonzero rows into columns.
B =
     1     0
     0     1
     1     1

>> % Check that the each column of A is a combination of the columns of B:
>> rref([ B A(:,1)])             % The first column of A.
ans =
     1     0     1
     0     1     0
     0     0     0

>> rref([ B A(:,2)])             % The second column of A.
ans =
     1     0    -1
     0     1     1
     0     0     0

>> rref([ B A(:,3)])             % The third column of A.
ans =
     1     0     2
     0     1     4
     0     0     0

>> rref([ B A(:,4)])             % The fourth column of A.
ans =
     1     0     3
     0     1     3
     0     0     0
```

(ii) From 11.

```

>> % In each case above, there was a unique solution to [B A(:,j)].
>> A = [ 1 -1 2 1; -1 0 1 2; 1 -2 5 4; 2 -1 1 -1];
>> R = rref(A')
R =
     1     0     2     1
     0     1     1    -1
     0     0     0     0
     0     0     0     0

>> B = ( R([1:2], :) )'           % Turn the nonzero rows into columns.
B =
     1     0
     0     1
     2     1
     1    -1

>> % Check that the each column of A is a combination of the columns of B:
>> rref([ B A(:,1)])             % The first column of A.
ans =
     1     0     1
     0     1    -1
     0     0     0
     0     0     0

>> rref([ B A(:,2)])             % The second column of A.
ans =
     1     0    -1
     0     1     0
     0     0     0
     0     0     0

>> rref([ B A(:,3)])             % The third column of A.
ans =
     1     0     2
     0     1     1
     0     0     0
     0     0     0

>> rref([ B A(:,4)])             % The fourth column of A.
ans =
     1     0     1
     0     1     2
     0     0     0
     0     0     0

```

(iii) From 12.

```

>> % In each case above, there was a unique solution to [B A(:,j)].
>> A = [1 -1 2 3; -2 2 -4 -6; 2 -2 4 6; 3 -3 6 9];
>> R = rref(A')
R =
     1    -2     2     3
     0     0     0     0
     0     0     0     0
     0     0     0     0

```



```

>> B = ( R([1], :) )'           % Turn the nonzero rows into columns.
B =
     1
    -2
     2
     3

>> % Check that the each column of A is a combination of the columns of B:
>> rref([ B A(:,1)])           % The first column of A.
ans =
     1     1
     0     0
     0     0
     0     0

>> rref([ B A(:,2)])           % The second column of A..
ans =
     1    -1
     0     0
     0     0
     0     0

>> rref([ B A(:,3)])           % The third column of A.
ans =
     1     2
     0     0
     0     0
     0     0

>> rref([ B A(:,4)])           % The fourth column of A.
ans =
     1     3
     0     0
     0     0
     0     0

```

(iv) From 13.

```

>> % In each case above, there was a unique solution to [B A(:,j)].
>> A = [-1 -1 0 0; 0 0 2 3; 4 0 -2 1; 3 -1 0 4];
>> R = rref(A')
R =
     1     0     0     1
     0     1     0     1
     0     0     1     1
     0     0     0     0

>> B = ( R([1:3], :) )'       % Turn the nonzero rows into columns.
B =
     1     0     0
     0     1     0
     0     0     1
     1     1     1

```

```

>> % Check that the each column of A is a combination of the columns of B:
>> rref([ B A(:,1)])           % The first column of A.
ans =
    1     0     0    -1
    0     1     0     0
    0     0     1     4
    0     0     0     0

>> rref([ B A(:,2)])           % The second column of A.
ans =
    1     0     0    -1
    0     1     0     0
    0     0     1     0
    0     0     0     0

>> rref([ B A(:,3)])           % The third column of A.
ans =
    1     0     0     0
    0     1     0     2
    0     0     1    -2
    0     0     0     0

>> rref([ B A(:,4)])           % The fourth column of A.
ans =
    1     0     0     0
    0     1     0     3
    0     0     1     1
    0     0     0     0

```

(v)

```

>> % In each case above, there was a unique solution to [B A(:,j)].
>> A = round(10*(2*rand(5)-1)); A(:,2) = .5*A(:,1);
>> A(:,4) = A(:,1) - 1/3 *A(:,3)
A =
 -6.0000  -3.0000   1.0000  -6.3333   1.0000
 -9.0000  -4.5000   3.0000 -10.0000  -8.0000
  4.0000   2.0000 -10.0000   7.3333   3.0000
  4.0000   2.0000  -2.0000   4.6667  -2.0000
  9.0000   4.5000  -9.0000  12.0000   4.0000

>> R = rref(A')
R =
  1.0000     0     0  -0.8617  -0.5651
     0   1.0000     0   0.2084  -0.2866
     0     0   1.0000   0.1764   0.7575
     0     0     0     0     0
     0     0     0     0     0

```

```

>> B = ( R([1:3], :) )'      % Turn the nonzero rows into columns.
B =
    1.0000         0         0
         0    1.0000         0
         0         0    1.0000
   -0.8617    0.2084    0.1764
   -0.5651   -0.2866    0.7575
>> % Check that the each column of A is a combination of the columns of B:
>> rref([ B A(:,1)])        % The first column of A.
ans =
     1     0     0    -6
     0     1     0    -9
     0     0     1     4
     0     0     0     0
     0     0     0     0
>> rref([ B A(:,2)])        % The second column of A.
ans =
    1.0000         0         0   -3.0000
         0    1.0000         0   -4.5000
         0         0    1.0000    2.0000
         0         0         0         0
         0         0         0         0
>> rref([ B A(:,3)])        % The third column of A.
ans =
     1     0     0     1
     0     1     0     3
     0     0     1   -10
     0     0     0     0
     0     0     0     0
>> rref([ B A(:,4)])        % The fourth column of A.
ans =
    1.0000         0         0   -6.3333
         0    1.0000         0  -10.0000
         0         0    1.0000    7.3333
         0         0         0         0
         0         0         0         0
>> rref([ B A(:,5)])        % The fifth column of A.
ans =
     1     0     0     1
     0     1     0    -8
     0     0     1     3
     0     0     0     0
     0     0     0     0
>> % In each case above, there was a unique solution to [B A(:,j)].

```

8. (i) From problem 7.

```
>> A = [1 -1 2 3; 0 1 4 3; 1 0 6 6];
```

(a)

```
>> R = rref(A)
R =
     1     0     6     6
     0     1     4     3
     0     0     0     0
```

```
>> % See problem 7 for rref(A') and answer to part (b).
```

(b)

```
>> B = R([1:2], :)           % a basis for the row space.
B =
     1     0     6     6
     0     1     4     3
```

(d) The dimensions of the row space and the column space were both 2.

(e) The number of pivots in `rref(A)` and `rref(A')` are the same.

(ii) From 11.

```
>> A = [ 1 -1 2 1; -1 0 1 2; 1 -2 5 4; 2 -1 1 -1];
```

(a)

```
>> R = rref(A)
R =
     1     0    -1    -2
     0     1    -3    -3
     0     0     0     0
     0     0     0     0
```

```
>> % See problem 7 for rref(A') and answer to part (b).
```

(c) A basis for the row space is given by the nonzero rows in R:

```
>> B = R([1:2], :)
B =
     1     0    -1    -2
     0     1    -3    -3
```

(d) The dimensions of the row space and the column space were both 2.

(iii) From 12.

```
>> A = [1 -1 2 3; -2 2 -4 -6; 2 -2 4 6; 3 -3 6 9];
```

(a)

```
>> R = rref(A)
R =
     1    -1     2     3
     0     0     0     0
     0     0     0     0
     0     0     0     0
```

```
>> % See problem 7 for rref(A') and answer to part (b).
```

(c) A basis for the row space.

```
>> B = R([1],:);
B =
    1    -1     2     3
```

(d) The dimensions of the row space and the column space were both 1.

(iv) From 13.

```
>> A = [-1 -1 0 0; 0 0 2 3; 4 0 -2 1; 3 -1 0 4];
```

(a)

```
>> R = rref(A)
R =
    1.0000     0     0     1.0000
         0     1.0000     0    -1.0000
         0     0     1.0000     1.5000
         0     0     0         0
```

```
>> % See problem 7 for rref(A') and answer to part (b).
```

(c) A basis for the row space.

```
>> B = R([1:3],:);
B =
    1.0000     0     0     1.0000
         0     1.0000     0    -1.0000
         0     0     1.0000     1.5000
```

(d) The dimensions of the row space and the column space were both 3.

(v)

```
>> A = round(10*(2*rand(5)-1)); A(:,2) = .5*A(:,1);
>> A(:,4) = A(:,1) - 1/3 *A(:,3)
```

```
A =
    8.0000    4.0000   -5.0000    9.6667    5.0000
    5.0000    2.5000   10.0000    1.6667     0
   -5.0000   -2.5000    4.0000   -6.3333   -5.0000
   -9.0000   -4.5000    5.0000  -10.6667   -5.0000
    5.0000    2.5000    3.0000    4.0000   -3.0000
```

(a)

```
>> R = rref(A)
R =
    1.0000    0.5000     0     1.0000     0
         0         0     1.0000   -0.3333     0
         0         0         0         0     1.0000
         0         0         0         0         0
         0         0         0         0         0
```

```
>> % See problem 7 for rref(A') and answer to part (b).
```

(c) A basis for the row space.

```
>> B = R([1:3], :)
B =
    1.0000    0.5000         0    1.0000         0
         0         0    1.0000   -0.3333         0
         0         0         0         0    1.0000
```

- (d) The dimensions of the row space and the column space were both 3.
- (d) The dimensions of the row space and the column space of A will always be the same.
- (e) The number of nonzero rows in $\text{rref}(A)$ and $\text{rref}(A')$ is the same. The number of nonzero rows is the dimension of the row space of a matrix. So this verifies (d) as row space of A' "is" column space of A after taking transposes.
9. (a) See MATLAB 4.4, Problems 3 and 7.
- (b) In each case, C will be the matrix formed as in problem 6.
- (i)

```
>>                                     % The first matrix.
>> A = [ 1 -2 3; -2 4 -6; 1 0 1]'; % Note the ' to make rows into columns
>> rref(A)
ans =
     1     -2     0
     0     0     1
     0     0     0
```

```
>> B = A(:, [1 3]) % B is the 1st and 3rd columns of A.
B =
     1     1
    -2     0
     3     1
```

(ii)

```
>> rref(B) % These should be linearly independent.
ans =
     1     0
     0     1
     0     0
```

(iii)

```
>> R = rref(A'); C = R([1:2],:); % From problem 6, R has 2 non-zero rows.
```

(iv)

```
>> rref([B C]), rref([C B]) % Both of these systems should be solvable.
ans =
    1.0000         0         0   -0.5000
         0    1.0000    1.0000    0.5000
         0         0         0         0
ans =
     1     0     1     1
     0     1    -2     0
     0     0     0     0
```

(i) The 2nd matrix.

```
>> A = [ 1 -1 0 3 -1 4; 2 0 1 7 2 1/2; 3 5 1 4 1 5]';
>> rref(A)
ans =
    1     0     0
    0     1     0
    0     0     1
    0     0     0
    0     0     0
    0     0     0
```

```
>> B = A(:, [1 2 3])           % B is the first 3 columns of A.
B =
    1.0000    2.0000    3.0000
   -1.0000         0    5.0000
         0    1.0000    1.0000
    3.0000    7.0000    4.0000
   -1.0000    2.0000    1.0000
    4.0000    0.5000    5.0000
```

(ii)

```
>> rref(B)                   % These should be linearly independent.
ans =
    1     0     0
    0     1     0
    0     0     1
    0     0     0
    0     0     0
    0     0     0
```

(iii)

```
>> R = rref(A'); C = R([1:3],:); % From problem 6, R has 3 non-zero rows.
```

(iv)

```
>> rref([B C]), rref([C B])  % Both of these systems should be solvable.
ans =
    1.0000         0         0    0.8333   -0.1667   -1.6667
         0    1.0000         0   -0.1667   -0.1667    1.3333
         0         0    1.0000    0.1667    0.1667   -0.3333
         0         0         0         0         0         0
         0         0         0         0         0         0
         0         0         0         0         0         0

ans =
    1     0     0     1     2     3
    0     1     0    -1     0     5
    0     0     1     0     1     1
    0     0     0     0     0     0
    0     0     0     0     0     0
    0     0     0     0     0     0
```

(i) For 3rd Matrix.

```
>> A = [ 1 2 -1 3 1; -1 0 1 2 0; ...
        5 4 -5 0 2; 1 2 3 -2 0; 6 8 -2 3 3]';
```

```
>> rref(A)
```

```
ans =
    1     0     2     0     3
    0     1    -3     0    -2
    0     0     0     1     1
    0     0     0     0     0
    0     0     0     0     0
```

```
>> B = A(:,[1 2 4])
```

```
B =
    1    -1     1
    2     0     2
   -1     1     3
    3     2    -2
    1     0     0
```

```
% B is the 1st, 2nd and 4th columns of A.
% Since those have pivots.
```

(ii)

```
>> rref(B)
```

```
ans =
    1     0     0
    0     1     0
    0     0     1
    0     0     0
    0     0     0
```

```
% These should be linearly independent.
```

(iii)

```
>> R = rref(A'); C = R([1:3],:); % From problem 6, R has 3 non-zero rows.
```

(iv)

```
>> rref([B C]), rref([C B]) % Both of these systems should be solvable.
```

```
ans =
    1.0000     0     0    -0.2500     0.5000    -0.2500
     0     1.0000     0    -1.0000     0.5000     0
     0     0     1.0000     0.2500     0     0.2500
     0     0     0     0     0     0
     0     0     0     0     0     0
```

```
ans =
```

```
    1     0     0     1    -1     1
    0     1     0     2     0     2
    0     0     1    -1     1     3
    0     0     0     0     0     0
    0     0     0     0     0     0
```

- (c) (Solutions only given for part (i) of (b). For (b.ii) note independence of columns of B follows from the fact that $\text{rref}(B)$ consists of pivot columns of $\text{rref}(A)$. For (c) count columns and compare with solutions to MATLAB Problem 7.

```
>> A = [1 -1 2 3; 0 1 4 3; 1 0 6 6]; % Matrix (i) from #7.
>> rref(A)
ans =
     1     0     6     6
     0     1     4     3
     0     0     0     0

>> B = A(:, [1 2])
B =
     1    -1
     0     1
     1     0

>> A = [1 -1 2 1; -1 0 1 2; 1 -2 5 4; 2 -1 1 -1]; % Matrix (ii) from #11.
>> rref(A)
ans =
     1     0    -1    -2
     0     1    -3    -3
     0     0     0     0
     0     0     0     0

>> B = A(:, [1 2])
B =
     1    -1
    -1     0
     1    -2
     2    -1

>> A = [1 -1 2 3; -2 2 -4 -6; 2 -2 4 6; 3 -3 6 9]; % Matrix (iii) from #12.
>> rref(A)
ans =
     1    -1     2     3
     0     0     0     0
     0     0     0     0
     0     0     0     0

>> B = A(:, [1])
B =
     1
    -2
     2
     3

>> A = [-1 -1 0 0; 0 0 2 3; 4 0 -2 1; 3 -1 0 4]; % Matrix (iv) from #13
>> rref(A)
ans =
  1.0000         0         0         1.0000
         0         1.0000         0        -1.0000
         0         0         1.0000         1.5000
         0         0         0         0
```

```

>> B = A(:, [1 2 3])
B =
    -1    -1     0
     0     0     2
     4     0    -2
     3    -1     0
>> A = round(10*(2*rand(5)-1)); A(:,2) = .5*A(:,1); % Matrix (v).
>> A(:,4) = A(:,1) - 1/3 *A(:,3)
A =
   -6.0000   -3.0000    1.0000   -6.3333    1.0000
   -9.0000   -4.5000    3.0000  -10.0000   -8.0000
    4.0000    2.0000  -10.0000    7.3333    3.0000
    4.0000    2.0000   -2.0000    4.6667   -2.0000
    9.0000    4.5000   -9.0000   12.0000    4.0000
>> rref(A)
ans =
    1.0000    0.5000         0    1.0000         0
         0         0    1.0000   -0.3333         0
         0         0         0         0    1.0000
         0         0         0         0         0
         0         0         0         0         0
>> B = A(:, [1 3 5])
B =
    -6     1     1
    -9     3    -8
     4    -10     3
     4     -2    -2
     9    -9     4

```

10. (i) (a)

```

>> A = round(10*( 2*rand(5,3)-1));
>> B = [A eye(5)]
B =
    -1     7     3     1     0     0     0     0
     9    -7     5     0     1     0     0     0
    -9   -10     5     0     0     1     0     0
     5     4    10     0     0     0     1     0
     5     7     8     0     0     0     0     1
>> rref(B) % Every row has a pivot so columns span.
ans =
Columns 1 through 7
    1.0000         0         0         0         0   -0.1199    0.3628
         0    1.0000         0         0         0    0.0315   -0.3060
         0         0    1.0000         0         0    0.0473    0.0410
         0         0         0    1.0000         0   -0.4826    2.3817
         0         0         0         0    1.0000    1.0631   -5.6120
Column 8
   -0.3785
    0.3628
    0.0442
   -3.0505
    5.7256

```

(b)

```

>> C = B(:, [1:5])
C =
   -1     7     3     1     0
     9    -7     5     0     1
    -9   -10     5     0     0
     5     4    10     0     0
     5     7     8     0     0

>> % The first three columns of C are the same as A.
>> rref(C) % This should be the identity:
ans = % In fact its rref(B)(:,1:5)
     1     0     0     0     0 % Therefore columns of C are a basis.
     0     1     0     0     0
     0     0     1     0     0
     0     0     0     1     0
     0     0     0     0     1

```

(ii) (a)

```

>> A = [ 1 2 3 1; 2 8 9 3; -1 1 -3 -1]';
>> B = [ A eye(4)]
B =
     1     2    -1     1     0     0     0
     2     8     1     0     1     0     0
     3     9    -3     0     0     1     0
     1     3    -1     0     0     0     1

>> rref(B) % Every row has a pivot
ans =
  1.0000     0     0   3.6667   0.3333     0  -3.3333
         0   1.0000     0  -1.0000     0     0   1.0000
         0     0   1.0000   0.6667   0.3333     0  -1.3333
         0     0     0     0     0   1.0000  -3.0000

```

(b)

```

>> C = B(:, [1 2 3 6])
C =
     1     2    -1     0
     2     8     1     0
     3     9    -3     1
     1     3    -1     0

>> % The first three columns of C are the same as A.
>> rref(C) % This should be the identity.
ans =
     1     0     0     0
     0     1     0     0
     0     0     1     0
     0     0     0     1

```

- (c) Since the columns making up the identity span \mathbb{R}^n , the total set of vectors will still span \mathbb{R}^n . Hence the set can be reduced to a basis by taking columns in B with pivots in $\text{rref}(B)$. Since the original set is linearly independent, the columns corresponding to these vectors will have pivots in them.

11. (i) From problem 7.

```
>> A = [1 -1 2 3; 0 1 4 3; 1 0 6 6];
>> R = rref(A'); B = ( R([1:2], :) )'; % Solution from problem 7.
>> C = orth(A) % This is an orthogonal basis.
C =
    0.2673    0.7715
    0.5345   -0.6172
    0.8018    0.1543

>> rref([C B]), rref([B C]) % Both of these show unique solutions, since
ans = % Pivots are in columns of the first matrix.
    1.0000         0    1.0690    1.3363
         0    1.0000    0.9258   -0.4629
         0         0         0         0
ans =
    1.0000         0    0.2673    0.7715
         0    1.0000    0.5345   -0.6172
         0         0         0         0
```

(ii) From 11.

```
>> A = [ 1 -1 2 1; -1 0 1 2; 1 -2 5 4; 2 -1 1 -1];
>> R = rref(A'); B = ( R([1:2], :) )'; % Solution from problem 7.
>> C = orth(A) % This is an orthogonal basis.
C =
    0.3592    0.2178
    0.1796   -0.5663
    0.8980   -0.1307
    0.1796    0.7841

>> rref([C B]), rref([B C]) % Both of these show unique solutions.
ans =
    1.0000         0    2.3349    0.8980
         0    1.0000    0.7405   -1.4811
         0         0         0         0
         0         0         0         0
ans =
    1.0000         0    0.3592    0.2178
         0    1.0000    0.1796   -0.5663
         0         0         0         0
         0         0         0         0
```

(iii) From 12.

```
>> A = [1 -1 2 3; -2 2 -4 -6; 2 -2 4 6; 3 -3 6 9];
>> R = rref(A'); B = ( R([1], :) )'; % Solution from problem 7.
>> C = orth(A) % This is an orthogonal basis.
C =
   -0.2357
    0.4714
   -0.4714
   -0.7071
```

```
>> rref([C B]), rref([B C])    % Both of these show unique solutions.
ans =
    1.0000   -4.2426
         0         0
         0         0
         0         0

ans =
    1.0000   -0.2357
         0         0
         0         0
         0         0
```

(iv) From 13.

```
>> A = [-1 -1 0 0; 0 0 2 3; 4 0 -2 1; 3 -1 0 4];
>> R = rref(A'); B = (R([1:3], :))'; % Solution from problem 7.
>> C = orth(A)                % This is an orthogonal basis.
C =
    0.1961    0.1531   -0.8295
         0    0.7464    0.4392
   -0.7845   -0.3636    0.0488
   -0.5883    0.5359   -0.3416

>> rref([C B]), rref([B C])    % Both of these show unique solutions.
ans =
    1.0000         0         0   -0.3922   -0.5883   -1.3728
         0    1.0000         0    0.6890    1.2823    0.1723
         0         0    1.0000   -1.1711    0.0976   -0.2928
         0         0         0         0         0         0

ans =
    1.0000         0         0    0.1961    0.1531   -0.8295
         0    1.0000         0         0    0.7464    0.4392
         0         0    1.0000   -0.7845   -0.3636    0.0488
         0         0         0         0         0         0
```

12. We will use the method from problem 9, once we convert to vector terms as in earlier sections.

(a)

```
>> A = [3 0 4 -1; -1 0 0 -1; 0 -2 1 0; 4 1 3 0]'; % ' allows entry as rows
>> rref(A)
ans =
     1     0     0     0
     0     1     0     0
     0     0     1     0
     0     0     0     1

>> % Since this set is linearly independent. It is a basis for its span.
```

(b)

```
>> A = [-6 4 -9 4; -2 7 0 -9; -18 29 -18 -19; -2 2 4 0]';
>> rref(A)
ans =
     1     0     2     0
     0     1     3     0
     0     0     0     1
     0     0     0     0
```

```
>> B = A(:, [1 2 4])           % The basis is the 1st, 2nd and 4th elements.
B =
   -6    -2    -2
    4     7     2
   -9     0     4
    4    -9     0
```

For part (a), the set of all four polynomials is a basis. For part (b), the set of the first, second, and fourth matrix form the basis.

13. (a)

```
>> n = 4; A = round(10*(2*rand(n)-1))
A =
   -5     2    -5    -4
   -4     7    -2    -6
   -3    -2     1    -7
    0     7    -1     1
```

```
>> rref(A)
ans =
    1     0     0     0
    0     1     0     0
    0     0     1     0
    0     0     0     1
```

```
>> rank(A)
ans =
    4
```

(b)

```
>> B = A; B(:,2) = B(:,1) - 3*B(:,4);
>> rref(B)
ans =
    1.0000     0     0    0.3333
     0    1.0000     0   -0.3333
     0     0    1.0000     0
     0     0     0     0
```

```
>> rank(B)
ans =
    3
```

B is not invertible since the columns are dependent, due to row of zeros.

(c)

```
>> B(:,3) = 2*B(:,2);
>> rref(B)
ans =
    1.0000     0     0    0.3333
     0    1.0000    2.0000   -0.3333
     0     0     0     0
     0     0     0     0
```

```
>> rank(B)
ans =
     2
```

B is still not invertible for the same reason.

- (d) Repeat for other n 's.
- (e) The rank of A is the number of pivots in `rref(A)`.
- (f) The $n \times n$ matrix A is invertible if and only if the rank of A is n .
- (g)

```
>> n = 5; B = round(10*(2*rand(n)-1)); % Create a random matrix of size 5.
>> B(:,2) = B(:,1) - 3*B(:,4); % Set 5-2 columns to be multiples of others.
>> B(:,3) = 2*B(:,2);
>> B(:,5) = 2*B(:,1) + 2*B(:,2);
>> rank(B)
ans =
     2
```

```
>> n = 6; B = round(10*(2*rand(n)-1)); % Create a random matrix of size 6.
>> B(:,2) = B(:,1) - 3*B(:,4); % Set 6-4 columns to be multiples of others.
>> B(:,3) = 2*B(:,2);
>> rank(B)
ans =
     4
```

14. (a)

```
>> A = round( 10*(2*rand(2,3)-1));
>> rank(A), rank(A')
ans =
     2
ans =
     2

>> A = round( 10*(2*rand(4,5)-1));
>> rank(A), rank(A')
ans =
     4
ans =
     4

>> A = round( 10*(2*rand(7,3)-1));
>> rank(A), rank(A')
ans =
     3
ans =
     3
```

(b)

```
>> n = 6;
>> A = round( 10*(2*rand(n)-1));
>> rank(A), rank(A')
ans =
     6
ans =
     6
```

```

>> A = round( 10*(2*rand(n)-1));
>> A(:,2) = A(:,1) - 3*A(:,4); % reduce the rank of A.
>> A(:,3) = 2*A(:,2);
>> rank(A), rank(A')
ans =
     4
ans =
     4

>> A = round( 10*(2*rand(n)-1));
>> A(:,3) = 2*A(:,2); % reduce the rank of A.
>> A(:,4) = -1*A(:,3);
>> A(:,5) = A(:,3)-2*A(:,2);
>> rank(A), rank(A')
ans =
     3
ans =
     3

```

(c) $\text{rank}(A)=\text{rank}(A')$.

(d) Since $\text{rank}(A)$ is the dimension of the column space, by problem 8, this should be the same as $\text{rank}(A')$, which is the dimension of the row space.

15. Using A for the augmented matrix, and C for the coefficient matrix:

```

>> A = [ 1 -2 3 11; 4 1 -1 4; 2 -1 3 10]; % For problem 1, section 1.3
>> C = A(:, [1:3]);
>> rank(A),rank(C)
ans =
     3
ans =
     3

>> A = [-2 1 6 18; 5 0 8 -16; 3 2 -10 -3];
>> C = A(:, [1:3]);
>> rank(A),rank(C)
ans =
     3
ans =
     3

>> % For problem 2.
>> A = [3 6 -6 9; 2 -5 4 6; 5 28 -26 -8];
>> C = A(:, [1:3]);
>> rank(A),rank(C)
ans =
     3
ans =
     2

>> A = [1 1 -1 7; 4 -1 5 4; 6 1 3 20];
>> C = A(:, [1:3]);
>> rank(A),rank(C)
ans =
     3
ans =
     2

```



```

>>                                     % For problem 3.
>> A = [ 3 5 1 0; 4 2 -8 0; 8 3 -18 0];
>> C = A(:, [1:3]);
>> rank(A),rank(C)
ans =
     2
ans =
     2

>> A = [ 9 27 3 3 12; 9 27 10 1 19; 1 3 5 9 6];
>> C = A(:, [1:4]);
>> rank(A),rank(C)
ans =
     3
ans =
     3

```

If the rank of A and C are the same, then the system has a solution. If the augmented matrix has a higher rank, then the system has no solution.

16. (a)

```

>> m3=magic(3);m4=magic(4);m5=magic(5);m6=magic(6);...
>> m6=magic(6);m7=magic(7);m8=magic(8);m9=magic(9);
>> [rank(m3) rank(m4) rank(m5) rank(m6) rank(m7) rank(m8) rank(m9)]
ans =
     3     3     5     5     7     3     9

```

To generate other magic squares we can take m_i' , as transposing will only interchange row and column sums. Or we could interchange two rows, say via $m_i[2\ 1\ 3:i, :]$ and still have a magic square. Or any combination of transposes and row (or column) interchanges.

As to patterns in the ranks, all of the other magic squares constructed from the m_i will keep the same rank. So the sequence above will always be the same. Observe the *odd* i have $\text{rank}(m_i) = i$, i.e. $\text{rank}(m_5) = 5$. The even i may not seem to have any clear pattern. We experiment some more, continuing to use the same notation.

```

>> m10=magic(10);m11=magic(11);m12=magic(12);m13=magic(13);m14=magic(14);
>> [rank(m10) rank(m11) rank(m12) rank(m13) rank(m14)]
ans =
     7    11     3    13     9

```

Combined with the previous work these confirm the pattern for the odd order matrices and show

```

>> [ rank(m4) rank(m6) rank(m8) rank(m10) rank(m12) rank(m14)]
ans =
     3     5     3     7     3     9

```

Thus it appears that $\text{rank}(\text{magic}(4k)) = 3$ while $\text{rank}(\text{magic}(4k+2)) = 2k+3$.

(b)

```

>> A = [1 2 3; 4 5 6; 7 8 9];
>> rank(A)
ans =
     2

```

```
>> A = [1 2 3 4; 5 6 7 8; 9 10 11 12; 13 14 15 16];
>> rank(A)
ans =
     2
```

- Each of the matrices will have rank 2. Since the difference between any two consecutive rows is $n * [1 \ 1 \ \dots \ 1]$, the first row and $[1 \ 1 \ \dots \ 1]$ form a basis for the row space. Hence rank = 2, always.
- (c) $\text{rank}(\mathbf{u} * \mathbf{v}')$ will always be one, provided \mathbf{u} , \mathbf{v} are non-zero. In fact the j 'th column of $\mathbf{u} * \mathbf{v}'$ is $v_j \mathbf{u}$, multiple of \mathbf{u} . Hence \mathbf{u} is a basis for the column space of $\mathbf{u} * \mathbf{v}'$ (provided some $v_j \neq 0$, and $\mathbf{u} \neq \mathbf{0}$). So dimension of the column space is 1.

```
>> u = 2*rand(4,1)-1; v = 2*rand(4,1)-1;
>> A = u*v';
>> rank(A)
ans =
     1
```

These matrices will always have rank 1, since all columns are multiples of \mathbf{u} . (Provided $\mathbf{u} \neq \mathbf{0}$ and $\mathbf{v} \neq \mathbf{0}$.)

17. (a)

```
>> n = 4; A = round(10*(2*rand(n)-1));
>> m = 5; B = round(10*(2*rand(n,m)-1));
>> B(3,:) = B(1,:)-B(2,:); B(4,:) = B(2,:); % reduce the rank of B.
```

Note that to reduce the rank of a matrix with fewer rows than columns we must make some rows equal to linear combinations of other rows, rather than columns.

```
>> rank(A), rank(B), rank(A*B)
ans =
     4
ans =
     2
ans =
     2
```

If A is invertible, and B has rank k , then AB has rank k . This relates to problem 10 in MATLAB 4.5 because the rank of B is the number of linearly independent columns in B , and the conclusion of Problem 10 says multiplication by an A preserves independence of a collection of columns.

(b)

```
>> n = 6; A = round(10*(2*rand(n)-1));
>> A(3,:) = A(1,:)-A(2,:); A(4,:) = A(2,:); % reduce the rank of A.
>> m = 5; B = round(10*(2*rand(n,m)-1));
>> rank(A), rank(B), rank(A*B)
ans =
     4
ans =
     5
ans =
     4
```

(c) Form a 5×7 random matrix A and make two rows by linear combinations of other rows. A reasonable conjecture is the rank of AB is the minimum of the ranks of A and B .

(d)

```
>> A = [1 -1 0; 2 0 2; 3 1 4];
>> B = [ 1 -3 2; 1 -3 2; -1 3 -2];
>> rank(A), rank(B), rank(A*B)
ans =
     2
ans =
     1
ans =
     0
```

A refined (correct) conjecture is $\text{rank}(AB) \leq \min(\text{rank}(A), \text{rank}(B))$.

Section 4.8

Note most solutions compute transition matrix by computing C^{-1} . An alternative is to find $\mathbf{x}_B = C^{-1}\mathbf{x}$ by reduction $(C | \mathbf{x}) \rightarrow (I | C^{-1}, \mathbf{x})$ for $\mathbf{x} = (x_1 \cdots x_n)^t$.

$$1. C = \begin{pmatrix} 1 & 1 \\ 1 & -1 \end{pmatrix}; C^{-1} = \frac{-1}{2} \begin{pmatrix} -1 & -1 \\ -1 & 1 \end{pmatrix} = \frac{1}{2} \begin{pmatrix} 1 & 1 \\ 1 & -1 \end{pmatrix}; \frac{1}{2} \begin{pmatrix} 1 & 1 \\ 1 & -1 \end{pmatrix} \begin{pmatrix} x \\ y \end{pmatrix} = \begin{pmatrix} (x+y)/2 \\ (x-y)/2 \end{pmatrix}$$

$$\text{i.e. } (x+y)/2 \begin{pmatrix} 1 \\ 1 \end{pmatrix} + (x-y)/2 \begin{pmatrix} 1 \\ -1 \end{pmatrix} = \begin{pmatrix} x \\ y \end{pmatrix}.$$

$$2. C = \begin{pmatrix} 2 & 3 \\ -3 & -2 \end{pmatrix}; C^{-1} = \frac{1}{5} \begin{pmatrix} -2 & -3 \\ 3 & 2 \end{pmatrix}; \frac{1}{5} \begin{pmatrix} -2 & -3 \\ 3 & 2 \end{pmatrix} \begin{pmatrix} x \\ y \end{pmatrix} = \begin{pmatrix} (-2x-3y)/5 \\ (3x+2y)/5 \end{pmatrix}$$

$$3. C = \begin{pmatrix} 5 & 3 \\ 7 & -4 \end{pmatrix}; C^{-1} = \frac{-1}{41} \begin{pmatrix} -4 & -3 \\ -7 & 5 \end{pmatrix} = \frac{1}{41} \begin{pmatrix} 4 & 3 \\ 7 & -5 \end{pmatrix}; \frac{1}{41} \begin{pmatrix} 4 & 3 \\ 7 & -5 \end{pmatrix} \begin{pmatrix} x \\ y \end{pmatrix} = \begin{pmatrix} (4x+3y)/41 \\ (7x-5y)/41 \end{pmatrix}$$

$$4. C = \begin{pmatrix} -1 & -1 \\ -2 & 2 \end{pmatrix}; C^{-1} = \frac{1}{4} \begin{pmatrix} -2 & -1 \\ -2 & 1 \end{pmatrix}; \frac{1}{4} \begin{pmatrix} -2 & -1 \\ -2 & 1 \end{pmatrix} \begin{pmatrix} x \\ y \end{pmatrix} = \begin{pmatrix} (-2x-y)/4 \\ (-2x+y)/4 \end{pmatrix}$$

$$5. C = \begin{pmatrix} a & b \\ c & d \end{pmatrix}; C^{-1} = \frac{1}{ad-bc} \begin{pmatrix} d & -b \\ -c & a \end{pmatrix}; \frac{1}{ad-bc} \begin{pmatrix} d & -b \\ -c & a \end{pmatrix} \begin{pmatrix} x \\ y \end{pmatrix} = \frac{1}{ad-bc} \begin{pmatrix} dx-by \\ -cx+ay \end{pmatrix}$$

$$6. C = \begin{pmatrix} 1 & 0 & 1 \\ 0 & 0 & 1 \\ 0 & 1 & 1 \end{pmatrix}; C^{-1} = \begin{pmatrix} 1 & -1 & 0 \\ 0 & -1 & 1 \\ 0 & 1 & 0 \end{pmatrix}; C^{-1} \begin{pmatrix} x \\ y \\ z \end{pmatrix} = \begin{pmatrix} x-y \\ -y+z \\ y \end{pmatrix}$$

$$7. C = \begin{pmatrix} 1 & 1 & 1 \\ 0 & 1 & 1 \\ 0 & 0 & 1 \end{pmatrix}; C^{-1} = \begin{pmatrix} 1 & -1 & 0 \\ 0 & 1 & -1 \\ 0 & 0 & 1 \end{pmatrix}; C^{-1} \begin{pmatrix} x \\ y \\ z \end{pmatrix} = \begin{pmatrix} x-y \\ y-z \\ z \end{pmatrix}. \text{ Or } \begin{pmatrix} 1 & 1 & 1 & x \\ 0 & 1 & 1 & y \\ 0 & 0 & 1 & z \end{pmatrix} \rightarrow \begin{pmatrix} 1 & 0 & 0 & x-y \\ 0 & 1 & 0 & y-z \\ 0 & 0 & 1 & z \end{pmatrix}. \text{ So}$$

$$(x-y) \begin{pmatrix} 1 \\ 0 \\ 0 \end{pmatrix} + (y-z) \begin{pmatrix} 1 \\ 1 \\ 0 \end{pmatrix} + z \begin{pmatrix} 1 \\ 1 \\ 1 \end{pmatrix} = \begin{pmatrix} x \\ y \\ z \end{pmatrix}.$$

$$8. C = \begin{pmatrix} 1 & -1 & 0 \\ 0 & 1 & 1 \\ -1 & 0 & 1 \end{pmatrix}; C^{-1} = \frac{1}{2} \begin{pmatrix} 1 & 1 & -1 \\ -1 & 1 & -1 \\ 1 & 1 & 1 \end{pmatrix}; C^{-1} \begin{pmatrix} x \\ y \\ z \end{pmatrix} = \frac{1}{2} \begin{pmatrix} x+y-z \\ -x+y-z \\ x+y+z \end{pmatrix}$$

$$9. C = \begin{pmatrix} 2 & -1 & 3 \\ 1 & 4 & -2 \\ 3 & 5 & -4 \end{pmatrix}; C^{-1} = \frac{1}{31} \begin{pmatrix} 6 & -11 & 10 \\ 2 & 17 & -7 \\ 7 & 13 & -9 \end{pmatrix}; C^{-1} \begin{pmatrix} x \\ y \\ z \end{pmatrix} = \frac{1}{31} \begin{pmatrix} 6x-11y+10z \\ 2x+17y-7z \\ 7x+13y-9z \end{pmatrix}$$

$$10. C = \begin{pmatrix} a & b & c \\ 0 & d & e \\ 0 & 0 & f \end{pmatrix}; C^{-1} = \frac{1}{adf} \begin{pmatrix} df & -bf & be-dc \\ 0 & af & -ae \\ 0 & 0 & ad \end{pmatrix}; C^{-1} \begin{pmatrix} x \\ y \\ z \end{pmatrix} = \frac{1}{adf} \begin{pmatrix} dfx-bfy+(be-dc)z \\ afy-aez \\ adz \end{pmatrix}$$

The reduction method is easy for this problem.

$$11. C = \begin{pmatrix} 1 & -1 & -1 \\ 0 & 1 & 0 \\ 0 & 0 & 1 \end{pmatrix}; C^{-1} = \begin{pmatrix} 1 & 1 & 1 \\ 0 & 1 & 0 \\ 0 & 0 & 1 \end{pmatrix}; C^{-1} \begin{pmatrix} a_0 \\ a_1 \\ a_2 \end{pmatrix} = \begin{pmatrix} a_0+a_1+a_2 \\ a_1 \\ a_2 \end{pmatrix}, \text{ i.e. } (a_0+a_1+a_2)1 + a_1(x-$$

$$1) + a_2(x^2-1) = a_0 + a_1x + a_2x^2.$$

$$12. C = \begin{pmatrix} 6 & 2 & 3 \\ 0 & 3 & 4 \\ 0 & 0 & 5 \end{pmatrix}; C^{-1} = \frac{1}{90} \begin{pmatrix} 15 & -10 & -1 \\ 0 & 30 & -24 \\ 0 & 0 & 18 \end{pmatrix}; C^{-1} \begin{pmatrix} a_0 \\ a_1 \\ a_2 \end{pmatrix} = \begin{pmatrix} 15a_0-10a_1-a_2 \\ 30a_1-24a_2 \\ 18a_2 \end{pmatrix}$$

$$13. C = \begin{pmatrix} 1 & -1 & -1 \\ 1 & 1 & 0 \\ 0 & 0 & 1 \end{pmatrix}; C^{-1} = \frac{1}{2} \begin{pmatrix} 1 & 1 & 1 \\ -1 & 1 & -1 \\ 0 & 0 & 2 \end{pmatrix}; C^{-1} \begin{pmatrix} a_0 \\ a_1 \\ a_2 \end{pmatrix} = \frac{1}{2} \begin{pmatrix} a_0 + a_1 + a_2 \\ -a_0 + a_1 - a_2 \\ 2a_2 \end{pmatrix}$$

$$14. c_1 \begin{pmatrix} 1 & 1 \\ -1 & 0 \end{pmatrix} + c_2 \begin{pmatrix} 2 & 0 \\ 3 & 1 \end{pmatrix} + c_3 \begin{pmatrix} 0 & 1 \\ -1 & 0 \end{pmatrix} + c_4 \begin{pmatrix} 0 & -2 \\ 0 & 4 \end{pmatrix} = \begin{pmatrix} 2 & -1 \\ 4 & 6 \end{pmatrix}. \text{ Then, } c_1 = -10/7, c_2 = 12/7, \\ c_3 = 18/7, c_4 = 15/14.$$

$$15. C = \begin{pmatrix} 1 & 1 & 0 & 0 \\ 0 & 1 & 1 & 0 \\ 0 & 0 & 1 & 1 \\ 0 & 0 & 0 & 1 \end{pmatrix}; C^{-1} = \begin{pmatrix} 1 & -1 & 1 & -1 \\ 0 & 1 & -1 & 1 \\ 0 & 0 & 1 & -1 \\ 0 & 0 & 0 & 1 \end{pmatrix}; C^{-1} \begin{pmatrix} -6 \\ 5 \\ -3 \\ 2 \end{pmatrix} = \begin{pmatrix} -16 \\ 10 \\ -5 \\ 2 \end{pmatrix}. \text{ Then, } 2x^3 - 3x^2 + 5x - 6 = \\ -16(1) + (10(1+x) - 5(x+x^2) + 2(x^2+x^3))$$

$$16. C = \begin{pmatrix} 1 & 1 & 1 & 1 \\ 0 & -1 & -2 & -3 \\ 0 & 0 & 1 & 3 \\ 0 & 0 & 0 & -1 \end{pmatrix}; C^{-1} = \begin{pmatrix} 1 & 1 & 1 & 1 \\ 0 & -1 & -2 & -3 \\ 0 & 0 & 1 & 3 \\ 0 & 0 & 0 & -1 \end{pmatrix}; C^{-1} \begin{pmatrix} 5 \\ -1 \\ 4 \\ 0 \end{pmatrix} = \begin{pmatrix} 8 \\ -7 \\ 4 \\ 0 \end{pmatrix}. \text{ Then, } 4x^2 - x + 5 = \\ 8(1) - 7(1-x) + 4(1-x)^2.$$

$$17. \begin{pmatrix} 1 \\ 1 \end{pmatrix} = a_{11} \begin{pmatrix} 0 \\ 3 \end{pmatrix} + a_{21} \begin{pmatrix} 5 \\ -1 \end{pmatrix}; \begin{pmatrix} 2 \\ 3 \end{pmatrix} = a_{12} \begin{pmatrix} 0 \\ 3 \end{pmatrix} + a_{22} \begin{pmatrix} 5 \\ -1 \end{pmatrix}. \text{ Then, } a_{11} = 2/5, a_{21} = 1/5, a_{12} = \\ 17/15, a_{22} = 2/5. A = \frac{1}{15} \begin{pmatrix} 6 & 17 \\ 3 & 6 \end{pmatrix}; (\mathbf{x})_{B_2} = \frac{1}{15} \begin{pmatrix} 6 & 17 \\ 3 & 6 \end{pmatrix} \begin{pmatrix} 2 \\ -1 \end{pmatrix} = \begin{pmatrix} -1/3 \\ 0 \end{pmatrix}$$

$$18. \begin{pmatrix} 2 \\ -5 \end{pmatrix} = a_{11} \begin{pmatrix} -2 \\ 1 \end{pmatrix} + a_{21} \begin{pmatrix} -3 \\ 2 \end{pmatrix}; \begin{pmatrix} 7 \\ 3 \end{pmatrix} = a_{12} \begin{pmatrix} -2 \\ 1 \end{pmatrix} + a_{22} \begin{pmatrix} -3 \\ 2 \end{pmatrix}. \text{ Then, } a_{11} = 11, a_{21} = -8, \\ a_{12} = -23, a_{22} = 13. (\mathbf{x})_{B_2} = \begin{pmatrix} 11 & -23 \\ -8 & 13 \end{pmatrix} \begin{pmatrix} 4 \\ -1 \end{pmatrix} = \begin{pmatrix} 67 \\ -45 \end{pmatrix}$$

$$19. \begin{pmatrix} 1 \\ -1 \\ 0 \end{pmatrix} = a_{11} \begin{pmatrix} 3 \\ 0 \\ 0 \end{pmatrix} + a_{21} \begin{pmatrix} 1 \\ 2 \\ -1 \end{pmatrix} + a_{31} \begin{pmatrix} 0 \\ 1 \\ 5 \end{pmatrix}; \begin{pmatrix} 0 \\ 1 \\ -1 \end{pmatrix} = a_{12} \begin{pmatrix} 3 \\ 0 \\ 0 \end{pmatrix} + a_{22} \begin{pmatrix} 1 \\ 2 \\ -1 \end{pmatrix} + a_{32} \begin{pmatrix} 0 \\ 1 \\ 5 \end{pmatrix}; \\ \begin{pmatrix} 1 \\ 0 \\ 1 \end{pmatrix} = a_{13} \begin{pmatrix} 3 \\ 0 \\ 0 \end{pmatrix} + a_{23} \begin{pmatrix} 1 \\ 2 \\ -1 \end{pmatrix} + a_{33} \begin{pmatrix} 0 \\ 1 \\ 5 \end{pmatrix}; \text{ Then, } a_{11} = 16/33, a_{21} = -15/11, a_{31} = -1/11, \\ a_{12} = -2/11, a_{22} = 6/11, a_{32} = -1/11, a_{13} = 4/11, a_{23} = -1/11, a_{33} = 2/11. (\mathbf{x})_{B_2} = \\ \frac{1}{33} \begin{pmatrix} 16 & -6 & 12 \\ -15 & 18 & -3 \\ -3 & -3 & 6 \end{pmatrix} \begin{pmatrix} 2 \\ -1 \\ 4 \end{pmatrix} = \begin{pmatrix} 86/33 \\ -20/11 \\ 7/11 \end{pmatrix}$$

$$20. 2(1-x) + 3x + 3(x^2 - x - 1) = 3x^2 - 2x - 1. C = \begin{pmatrix} 3 & 1 & 0 \\ -2 & 1 & 1 \\ 0 & 0 & 1 \end{pmatrix}; C^{-1} = \frac{1}{5} \begin{pmatrix} 1 & -1 & 1 \\ 2 & 3 & -3 \\ 0 & 0 & 5 \end{pmatrix}; C^{-1} \begin{pmatrix} -1 \\ -2 \\ 3 \end{pmatrix} = \\ \begin{pmatrix} 4/5 \\ -17/5 \\ 3 \end{pmatrix}. \text{ Then, } 3x^2 - 2x - 1 = 4(3-2x)/5 - 17(1+x)/5 + 3(x+x^2)$$

$$21. \begin{vmatrix} 2 & 1 & -1 \\ 3 & -2 & 0 \\ 5 & 1 & 6 \end{vmatrix} = -55 \Rightarrow \text{linearly independent.}$$

$$22. \begin{vmatrix} -3 & 2 & 4 \\ 0 & -1 & 2 \\ 1 & 4 & 0 \end{vmatrix} = 32 \Rightarrow \text{linearly independent.}$$

$$23. \begin{vmatrix} 0 & -2 & 2 \\ 1 & 2 & 1 \\ 4 & 0 & 12 \end{vmatrix} = 0 \Rightarrow \text{linearly dependent.}$$

$$24. \begin{vmatrix} -2 & 3 & 6 \\ 4 & 1 & 8 \\ -2 & 0 & 0 \end{vmatrix} = -36 \Rightarrow \text{linearly independent.}$$

$$25. \begin{vmatrix} 1 & -1 & 2 & 4 \\ 0 & -3 & 5 & 6 \\ 1 & 4 & 0 & 3 \\ 0 & 5 & -6 & 7 \end{vmatrix} = -260 \Rightarrow \text{linearly independent.}$$

$$26. \begin{vmatrix} 2 & -3 & 1 & 11 \\ 0 & -2 & 0 & 2 \\ 3 & 7 & -1 & -5 \\ 4 & 1 & -3 & -5 \end{vmatrix} = 0 \Rightarrow \text{linearly dependent.}$$

$$27. \begin{vmatrix} 1 & 4 & -1 & 0 \\ -3 & 4 & 6 & 0 \\ 2 & 5 & -2 & 3 \\ 4 & 0 & 3 & 0 \end{vmatrix} = -183 \Rightarrow \text{linearly independent.}$$

$$28. \begin{vmatrix} a & b & d & g \\ 0 & c & e & h \\ 0 & 0 & f & j \\ 0 & 0 & 0 & k \end{vmatrix} = acfk \neq 0 \Rightarrow \text{linearly independent.}$$

29. $p_i(0) = 0$ implies that the constant term is zero for each polynomial. Then the first row of the matrix A (as in example 4) will be a row of zeros. Then $\det A = 0$, which implies that the polynomials are linearly dependent.

30. $p_i^{(j)}(0) = 0$ implies that the coefficient of the x^j term is zero for each polynomial. Then row $j + 1$ of the matrix A will be a row of zeros. So A not invertible, which implies that the polynomials are linearly dependent.

31. Note that the first row of matrix A (as in example 5) is a row of zeros. Then A not invertible which implies that the matrices are linearly dependent.

32. $(x', y') = (1, 0)$ corresponds to $(x, y) = (\cos \theta, \sin \theta)$.
 $(x', y') = (0, 1)$ corresponds to $(x, y) = (-\sin \theta, \cos \theta)$.

33. Since the basis elements $(1, 0)$ and $(0, 1)$ of the $x'y'$ -coordinate axis correspond to $(\cos \theta, \sin \theta)$ and $(-\sin \theta, \cos \theta)$ of the xy -coordinate axis, the change of coordinate matrix is given by

$$A^{-1} = \begin{pmatrix} \cos \theta & \sin \theta \\ -\sin \theta & \cos \theta \end{pmatrix}.$$

$$34. \begin{pmatrix} \sqrt{3}/2 & 1/2 \\ -1/2 & \sqrt{3}/2 \end{pmatrix} \begin{pmatrix} -4 \\ 3 \end{pmatrix} = \begin{pmatrix} (-4/\sqrt{3} + 3)/2 \\ -2 - 3\sqrt{3}/2 \end{pmatrix} \quad 35. \begin{pmatrix} \sqrt{2}/2 & \sqrt{2}/2 \\ -\sqrt{2}/2 & \sqrt{2}/2 \end{pmatrix} \begin{pmatrix} 2 \\ -7 \end{pmatrix} = \begin{pmatrix} -5\sqrt{2}/2 \\ -9\sqrt{2}/2 \end{pmatrix}$$

$$36. \begin{pmatrix} -1/2 & \sqrt{3}/2 \\ -\sqrt{3}/2 & -1/2 \end{pmatrix} \begin{pmatrix} 4 \\ 5 \end{pmatrix} = \begin{pmatrix} -2 + 5\sqrt{3}/2 \\ -2/\sqrt{3} - 5/2 \end{pmatrix}$$

37. Note problem meant $(\mathbf{c}_i)_{B_1} = \begin{pmatrix} c_{1i} \\ c_{2i} \\ \vdots \\ c_{ni} \end{pmatrix}$. Since C is invertible, the n columns of C are linearly inde-

pendent. Thus \mathbf{c}_i , $i = 1, \dots, n$ are independent. Since $\dim V = n$, then by Theorem 5 of section 4.6, $B_2 = \{\mathbf{c}_1, \mathbf{c}_2, \dots, \mathbf{c}_n\}$ is a basis for V .

38. This is from Theorem 2.

39. Let $CA = \begin{pmatrix} r_{11} & r_{12} & \cdots & r_{1n} \\ r_{21} & r_{22} & \cdots & r_{2n} \\ \vdots & \vdots & & \vdots \\ r_{n1} & r_{n2} & \cdots & r_{nn} \end{pmatrix}$. Suppose $CA = I$. Then $(\mathbf{x})_{B_1} = I(\mathbf{x})_{B_1} = CA(\mathbf{x})_{B_1}$, for every

$\mathbf{x} \in V$. Suppose $(\mathbf{x})_{B_1} = CA(\mathbf{x})_{B_1}$ for every $\mathbf{x} \in V$. Let $B_1 = \{\mathbf{v}_1, \mathbf{v}_2, \dots, \mathbf{v}_n\}$. Then $(\mathbf{v}_1)_{B_1} =$

$\begin{pmatrix} 1 \\ 0 \\ \vdots \\ 0 \end{pmatrix} = CA \begin{pmatrix} 1 \\ 0 \\ \vdots \\ 0 \end{pmatrix}$. But $CA \begin{pmatrix} 1 \\ 0 \\ \vdots \\ 0 \end{pmatrix} = \begin{pmatrix} r_{11} \\ r_{21} \\ \vdots \\ r_{n1} \end{pmatrix}$ = the first column of CA . Similarly, the second column

of $CA = \begin{pmatrix} 0 \\ 1 \\ \vdots \\ 0 \end{pmatrix} = (\mathbf{v}_2)_{B_1}$. Continuing in this manner, we have $CA = I$.

MATLAB 4.8

1. (a) We mimic the 'by hand' solution by finding `rref([v1 v2 w])`

```
>> rref( [ 1 -1 1; 1 1 2])
ans =
    1.0000         0    1.5000
         0    1.0000    0.5000

>> rref( [ 1 -1 -3; 1 1 4])
ans =
    1.0000         0    0.5000
         0    1.0000    3.5000
```

For (i), $(\mathbf{w})_B = (1.5, .5)^t$ and for (ii) $(\mathbf{w})_B = (.5, 3.5)^t$, which is what `lincomb(v1,v2,w)` shows.

- (b) To find the coefficients in $(\mathbf{w})_B$, we must solve $a\mathbf{v}_1 + b\mathbf{v}_2 = \mathbf{w}$. This can be written as the matrix equation

$$[\mathbf{v}_1 \ \mathbf{v}_2] \begin{bmatrix} a \\ b \end{bmatrix} = \mathbf{w},$$

whose augmented matrix is $[\mathbf{v}_1 \ \mathbf{v}_2 \ | \ \mathbf{w}]$.

2. (a) Let A be the matrix with vectors in B as columns.

```
>> A = [ 1 2 3 4; 2 5 5 8; 1 3 3 9; 0 -2 2 1];
>> rank(A) % Since the rank is 4, this is a basis.
ans =
    4
```

- (b) is the same as in problem 1.

- (c)

```
>> w = [1 2 -3 1]';
>> wb = A\w % This is the solution of Ax = w.
wb =
    42
    -9
    -9
     1

>> A*wb % This should be the same as w.
ans =
     1
     2
    -3
     1
```

- (d) (i)

```
>> A = [1 2 3 4; 1 3 2 4; 1 2 4 10; .5 1 1.5 2.5]; % (d) System (i).
>> w = round(10*(2*rand(4,1)-1));
>> wb = A\w % w in the basis B.
wb =
   -280
     64
     67
    -11
```

Computing $w - A \cdot w$ will yield 0 to within roundoff error.

(ii)

```
>> A = round(10*(2*rand(4,4)-1)); % Form B from the columns of A
>> w = round(10*(2*rand(4,1)-1));
>> wb = A \ w % Find coefficients of w in the basis B.
wb = % Since MATLAB issues no warnings.
    -5.8277 % A is invertible so B is an independent set.
    -2.7421
    -0.5824
     3.0477
```

3. (a) Reducing $[A \ I]$ gives the same information as reducing each of $[A \ w_i]$. Since that will give the solution of $Ax = w_i$, this will find the coefficients of w_i in the basis B , made up of the columns of A .

(b)

```
>> R = rref( [ A eye(4) ] )
R =
     1     0     0     0    -84    45     -5    21
     0     1     0     0     19   -10     1    -5
     0     0     1     0     21   -11     1    -5
     0     0     0     1     -4     2     0     1

>> C = R(:, [5:8]);
>> C - inv(A) % This should be zero.
ans =
     0     0     0     0
     0     0     0     0
     0     0     0     0
     0     0     0     0
```

Part (a) shows the i th column of C , say c_i solves $Ac_i = w_i$. Combining these says $AC = I$ since $w_i = e_i$, or $C = A^{-1}$.

(c)

```
>> w = [1 -2 3 4]';
```

(i)

```
>> rref([A w])
ans =
     1     0     0     0   -105 % Wb = last column.
     0     1     0     0     22
     0     0     1     0     26
     0     0     0     1     -4
```

(ii) $(w)_B = Cw = C \begin{pmatrix} 1 \\ -2 \\ 3 \\ 4 \end{pmatrix}$. From (a) the j th column of C is $(e_j)_B$ so

$$(w)_B = 1(e_1)_B - 2(e_2)_B + 3(e_3)_B + 4(e_4)_B$$

```
>> C*w % C*w = inv(A)* w, solves Ax = w.
ans =
    -105
     22
     26
     -4
```

(iii) The matrix C is the transition from the standard basis to B .

4. (a) Each part of MATLAB 4.4, problem 9, answered questions about some P_n by representing the polynomial $p_n(x) = a_0 + a_1x + \cdots + a_nx^n$ via the vector $(a_0, a_1, \dots, a_n)^t$. The vector is just $(p_n)_B$, the coordinate vector for p_n with respect to the standard basis $B = \{1, x, x^2, \dots, x^n\}$ for P_n .
- (b) For problem 14.

```
>> A = [1 -1 1 0; 2 3 0 1; 0 -1 1 0; 0 0 -2 4]'; % (Note the ')
>> w = [2 4 -1 6]';
>> A\w
% answer.
ans =
-1.4286
 1.7143
 2.5714
 1.0714
```

$$\text{i.e. } \text{ans}(1) \begin{pmatrix} 1 & 1 \\ -1 & 0 \end{pmatrix} + \text{ans}(2) \begin{pmatrix} 2 & 0 \\ 3 & 1 \end{pmatrix} + \text{ans}(3) \begin{pmatrix} 0 & 1 \\ -1 & 0 \end{pmatrix} + \text{ans}(4) \begin{pmatrix} 0 & -2 \\ 0 & 4 \end{pmatrix} = \begin{pmatrix} 2 & -1 \\ 4 & 6 \end{pmatrix}.$$

For problem 15.

```
>> A = [1 0 0 0; 1 1 0 0; 0 1 1 0; 0 0 1 1]';
>> w = [-6 5 -3 2]';
>> A\w
% answer.
ans =
-16
 10
 -5
 2
```

$$\text{i.e. } -16(1) + 10(1+x) - 5(x+x^2) + 2(x^2+x^3) = -6 + 5x - 3x^2 + 2x^3.$$

(c) For problem 16.

```
>> A = [1 0 0 0; 1 -1 0 0; 1 -2 1 0; 1 -3 3 -1]';
>> w = [5 -1 4 0]';
>> A\w
% answer.
ans =
 8
 -7
 4
 0
```

$$\text{i.e. } 8(1) - 7(1-x) + 4(1-x)^2 + 0(1-x)^3 = 4x^2 - x + 5.$$

5.

```
>> V = [1 1 1; 2 3 3; -3 2 3]';
>> W = [1 2 1; -1 -1 0; 2 9 8]'
```

(a)

```
>> rank(V), rank(W)
ans =
 3
ans =
 3
```

Since both ranks are 3, the columns of V , W both form bases for \mathbb{R}^3 .

- (b) Writing \mathbf{v}_j as a linear combination of the columns of $W = [\mathbf{w}_1 \ \mathbf{w}_2 \ \mathbf{w}_3]$ amounts to solving $W\mathbf{d}_j = \mathbf{v}_j$. Combining these three problems into one, we can solve them by reducing the extended augmented matrix $(W|V)$ to $(I|D)$, and reading off $(\mathbf{v}_j)_C$ as the j 'th column of D .

(c)

```
>> rref([W V])
ans =
    1.0000         0         0   -3.5000   -6.0000   12.0000
         0    1.0000         0   -3.5000   -6.0000   13.0000
         0         0    1.0000    0.5000    1.0000   -1.0000
```

So

```
>> v1C = ans(:,4);v2C = ans(:,5); v3C = ans(:,6);
>> D=[v1C v2C v3C]
D =
   -3.5000   -6.0000   12.0000
   -3.5000   -6.0000   13.0000
    0.5000    1.0000   -1.0000
```

(d)

```
>> x = [1 -2 -3]';
>> xb = V\x                               % x in basis B.
xb =
    -6
     2
    -1
>> xc = W\x                               % x in basis C.
xc =
    -3
    -4
     0
>> D*xb                                   % Same as xc.
ans =
    -3
    -4
     0
```

(e)

```
>> W\V                                     % Same as D above.
ans =
   -3.5000   -6.0000   12.0000
   -3.5000   -6.0000   13.0000
    0.5000    1.0000   -1.0000
```

(f)

```
>> V = [ 1 2 3 4; 2 5 5 8; 1 3 3 9; 0 -2 2 1];
>> W = [ 1 2 3 4; 1 3 2 4; 1 2 4 10; .5 1 1.5 2.5];
>> rref([W V])
ans =
     1     0     0     0   -27  -165    25   -81
     0     1     0     0     7    40    -4    21
     0     0     1     0     6    37    -6    17
     0     0     0     1    -1    -6     1    -2
```

```

>> v1C=ans(:,5);v2C=ans(:,6);v3C=ans(:,7);v4C=ans(:,8);
>> D=[v1C v2C v3C v4C]
D =
   -27   -165    25   -81
     7     40    -4    21
     6     37    -6    17
    -1     -6     1    -2

>> x= round(10*rand(4,1)-5)
x =
   -3
   -5
     2
     2

>> xb = V\x                               % x in basis B. Alternative: rref([V x])
xb =
    59
   -15
   -16
     4

>> xc = W\x                               % x in basis C. Alternative: rref([W x])
xc =
   158
   -39
   -37
     7

>> D*xb                                   % Should be same as xc
ans =
   158
   -39
   -37
     7

```

(g) $D = W^{-1}V$ can be explained in the following two ways:

- (i) The reduction $(W \mid V) \rightarrow (I \mid D)$ is accomplished by (left) multiplication by W^{-1} since $WD = V$ is solved by $ID = (W^{-1}W)D = W^{-1}V$.
- (ii) Since V is the transition matrix from B to the standard basis, and W^{-1} is the transition matrix from the standard basis to C , $D = W^{-1}V$ is the transition from B to C .

6. Problem 18.

```

>> V = [2 7; -5 3];                       % V is the transition matrix from B1 to S.
>> W = [0 5; 3 -1];                       % W is the transition matrix from B2 to S.
>> D = inv(W)*V                            % D is the transition matrix from B1 to B2.
D =
   -1.5333    1.4667
    0.4000    1.4000

>> x1 = [4; -1];                          % x in B1.
>> D*x1                                     % x in B2.
ans =
   -7.6000
    0.2000

```

Problem 19.

```
>> V = [1 0 1; -1 1 0; 0 -1 1]; % V is the transition matrix from B1 to S.
>> W = [3 1 0; 0 2 1; 0 -1 5]; % W is the transition matrix from B2 to S.
>> D = inv(W)*V % D is the transition matrix from B1 to B2.
D =
    0.4848   -0.1818    0.3636
   -0.4545    0.5455   -0.0909
   -0.0909   -0.0909    0.1818

>> x1 = [2; -1; 4]; % x in B1.
>> D*x1 % x in B2.
ans =
    2.6061
   -1.8182
    0.6364
```

Problem 20.

```
>> V = [1 -1 0; 0 3 0; -1 -1 1]'; % V is the transition matrix from B1 to S.
>> W = [3 -2 0; 1 1 0; 0 1 1]'; % W is the transition matrix from B2 to S.
>> D = inv(W)*V % D is the transition matrix from B1 to B2.
D =
    0.4000   -0.6000    0.2000
   -0.2000    1.8000   -1.6000
         0         0    1.0000

>> x1 = [2; 1; 3]; % x in B1.
>> D*x1 % x in B2.
ans =
    0.8000
   -3.4000
    3.0000
```

7. Let S be the standard basis.

```
>> U = [ 2 4 .5; 8 7 1; 5 3 .5] % The transition matrix from D to S.
```

(a)

```
>> T = inv(W)*V % The transtion from B to S and then to C, see 5c, g.
T =
   -3.5000   -6.0000   12.0000
   -3.5000   -6.0000   13.0000
    0.5000    1.0000   -1.0000

>> S = inv(U)*W
S =
    0.0000    0.0000   -2.0000
    0.0000   -1.0000  -13.0000
    2.0000    6.0000  116.0000

>> K = inv(U)*V
K =
   -1.0000   -2.0000    2.0000
   -3.0000   -7.0000    0.0000
   30.0000   68.0000  -14.0000
```

- (b) The transition from B to C , followed (on left) by transition from C to D gives the transition from B to D . So $K = S * T$.

```
>> S*T
ans =
   -1.0000   -2.0000    2.0000
   -3.0000   -7.0000    0.0000
   30.0000   68.0000  -14.0000
```

- (c) Repeat with random bases.

8.

```
>> V = [1 1 1; 2 3 3; -3 2 3]'; % The transition matrix B to S, by column.
>> A = [5 -6 4; 3 -19 19; 3 -24 24];
```

(a)

```
>> A * V(:,1) / 3 % This should be V(:,1).
ans =
     1
     1
     1

>> A * V(:,2) / 2 % This should be V(:,2).
ans =
     2
     3
     3

>> A * V(:,3) / 5 % This should be V(:,3).
ans =
    -3
     2
     3
```

(b)

```
>> xb = [-1; 2; 4];
>> x = V*xb % This is x in the standard basis, we need it
x = % before we can find Ax.
    -9
    13
    17

>> z = A*x
z =
   -55
    49
    69

>> zb = inv(V)*z % This is z in the basis B.
zb =
    -3
     4
    20
```

```

>> D = diag([3 2 5]);
>> D*xb                                % This should be the same as zb.
ans =
    -3
     4
    20

```

(c) We get the same result for any \mathbf{x} , $D * \mathbf{x} = A * \mathbf{x}$.

(d)

```

>> V*D*inv(V)                          % This should be the same as A.
ans =
     5     -6     4
     3    -19    19
     3    -24    24

```

(e)

```

>> V = [1 2 1; -1 -1 0; 2 9 8]'; % Note ' used so V can be entered by columns.
>> A = [37 -33 28; 48.5 -44.5 38.5; 12 -12 11];
>> A * V(:,1) / (-1)                    % This should be V(:,1).
ans =
     1
     2
     1

>> A * V(:,2) / 4                        % This should be V(:,2).
ans =
    -1
    -1
     0

>> A * V(:,3) / .5                       % This should be V(:,3).
ans =
     2
     9
     8

>> xb = [-1; 2; 4];
>> x = V*xb                               % This is x in the standard basis.
x =
     5
    32
    31

>> z = A*x
z =
    -3
    12
    17

>> zb = inv(V)*z                          % This is z in the basis B.
zb =
     1
     8
     2

```

```

>> D = diag([-1 4 .5]);
>> D*xb                                % This should be the same as zb.
ans =
     1
     8
     2
>> V*D*inv(V)                          % This should be the same as A
ans =
    37.0000   -33.0000    28.0000
    48.5000   -44.5000    38.5000
    12.0000   -12.0000    11.0000

```

(f) If $\mathbf{x} = a\mathbf{v}_1 + b\mathbf{v}_2 + c\mathbf{v}_3$ then $(\mathbf{x})_B = (a, b, c)^t$ and $D(\mathbf{x})_B = (ra, sb, tc)^t$ since $D = \text{diag}([r \ s \ t])$. However, $\mathbf{z} = A\mathbf{x} = aA\mathbf{v}_1 + bA\mathbf{v}_2 + cA\mathbf{v}_3 = ar\mathbf{v}_1 + bsv_2 + ct\mathbf{v}_3$. So, from the definition of the coordinate vector, $(\mathbf{z})_B = (ar, bs, ct)^t$. Thus $(\mathbf{z})_B = D(\mathbf{x})_B$.

Now notice that the matrix D represents the transformation A in the basis B from the first part. So applying A should be the same as changing to the basis B , applying D and then changing back to the standard basis, which is the same as applying VDV^{-1} .

9. (a) Rotation of the unit vector $\mathbf{e}_1 = (1, 0)^t$ by θ gives the point $\mathbf{v}_1 = (x_1, y_1)^t$ on the unit circle whose coordinates are $x_1 = \cos \theta$, $y_1 = \sin \theta$ from the definitions of \cos and \sin either in terms of triangles or as coordinates of points on the unit circle. Similarly $\mathbf{v}_2 = (-\sin \theta, \cos \theta)^t$ is the rotation of $\mathbf{e}_2 = (0, 1)^t$. Alternatively we could identify \mathbf{v}_2 as the rotation of \mathbf{e}_1 by $\theta + \pi/2$ and use trig identities like $\cos(\theta + \pi/2) = -\sin \theta$, $\sin(\theta + \pi/2) = \cos \theta$.

```

>> a = 1; b = 2;
>> M = sqrt(x'*x);
>> th = pi/2;
>> v1 = [cos(th); sin(th)]
>> v2 = [-sin(th); cos(th)];
>> V = [v1 v2]
>> x = [a;b]
>> w = V*x
>> % The next command is modified from text to produce distinct line types:
>> % solid=blue and dotted=red lines, visible in black and white
>> plot([0,x(1)],[0 x(2)],'-r', [0,w(1)], [0,w(2)],':b')
>> axis('square'); % Correct position for MATLAB 4.x.
>> axis([-M M -M M]); % These should precede plot in 3.5.
>> print -deps fig4_8_9.eps % Use this to save to a file except in PC MATLAB

```

- (b) Here is the sample graph from the text. The solid line is the original vector \mathbf{x} and the dotted line is the rotated vector \mathbf{w} . (Note solid=red, dotted=blue).

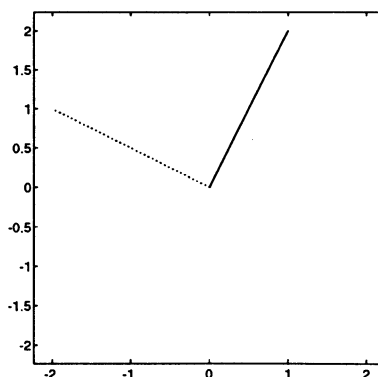

(c) (i)

```

>> t = pi/4;
>> B = [ cos(t) -sin(t); sin(t) cos(t)] % Columns of B are basis.
B =
    0.7071   -0.7071
    0.7071    0.7071

>> t = 2*pi/3;
>> C = [ cos(t) -sin(t); sin(t) cos(t)] % Columns of C are basis.
C =
   -0.5000   -0.8660
    0.8660   -0.5000

>> T = C\B % B to Standard followed by Std to C.
T =
    0.2588    0.9659
   -0.9659    0.2588

>> S = B\C % C to Std followed by Std to B.
S =
    0.2588   -0.9659
    0.9659    0.2588

```

(ii)

```

>> xb = [.5 ; 3]; % Coordinates in Basis B.
>> xc = T*xb % Use T to convert from B to C.
xc =
    3.0272
    0.2935

>> x = B*xb % Convert from B to the standard basis.
x =
   -1.7678
    2.4749

>> inv(c)*x % Convert Standard basis to C.
ans = % Same as xc.
    3.0272
    0.2935

```

(iii)

```

>> xc = [2; -1.4]; % Coordinates in C basis.
>> xb = S*xc % Use S to convert from C to B.
xb =
    1.8699
    1.5695

>> x = C*xc % Convert from C to the standard basis.
x =
    0.2124
    2.4321

```

```

>> inv(B)*x          % Convert from Standard bases to B.
ans =
    1.8699
    1.5695

```

(iv)

```

>> The labels on the x-axes in rotcoor graphs verify (ii) and (iii)
>> rotcoor(B,C,[.5 3]') % Rotate from pi/4 to 2pi/3 coordinates
>> print -deps fig489civ.ii.eps

```

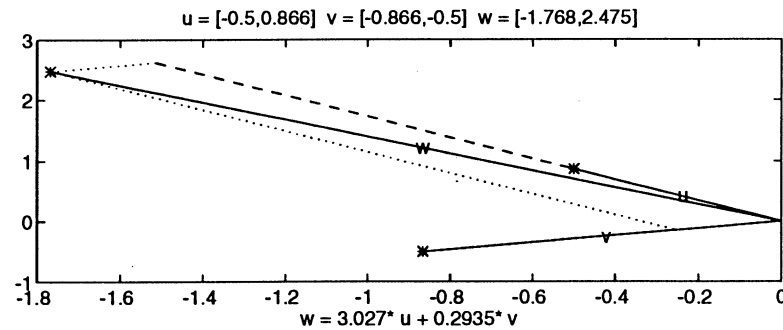
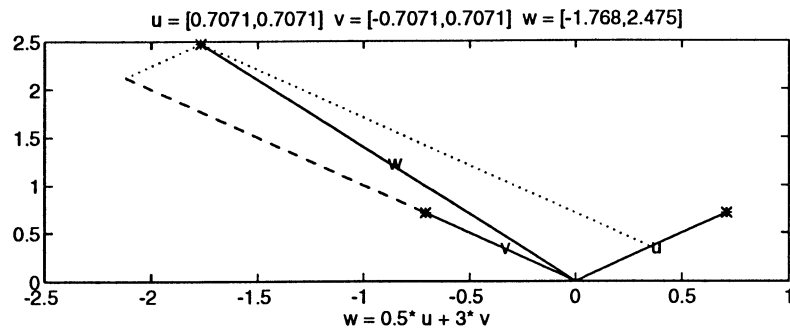

```

>> clg
>> rotcoor(C,B,[2 -1.4]') % Rotate from 2pi/3 to pi/4 coordinates
>> print -deps fig489civ.iii.eps

```

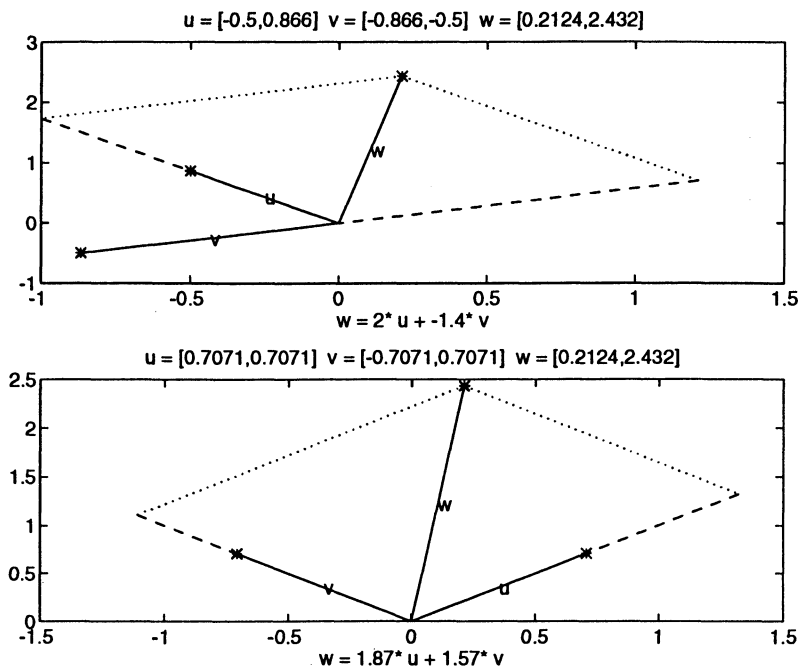

10. (a) (i) Rotation about z -axis by θ just acts on the x, y coordinates as if we were rotating in the (x, y) -plane. So the trig identities or basic definitions of the trig functions used in problem 9(a) above show \mathbf{v}, \mathbf{w} have the forms $\mathbf{v} = (\cos \theta, \sin \theta, 0)^t$, $\mathbf{w} = (-\sin \theta, \cos \theta, 0)^t$. The matrix $Y = [\mathbf{v} \ \mathbf{w} \ \mathbf{e}_3]$ is the transition matrix from the coordinates in the system rotated by θ around the z -axis to the standard coordinates.
- (ii) Repeat the reasoning above, except here all rotations are in the (y, z) -plane, as the x -axis is fixed. $R = [\mathbf{e}_1 \ \mathbf{v} \ \mathbf{w}]$ is the transition matrix from new coordinates in the system rotated by α around the x -axis back to the standard coordinates.
- (ii) As above except now all rotations are done in the (x, z) -plane since the y -axis is fixed. $P = [\mathbf{v} \ \mathbf{e}_2 \ \mathbf{w}]$ represents the transition from new coordinates in the system rotated by ϕ around the y -axis back to the standard coordinates.
- (b) Multiplying \mathbf{u} by YR on the left is the same as first multiplying \mathbf{u} by R on the left, which represents rotation by α around the x -axis, and next multiplying the resulting vector by Y on the left, which represents rotation by θ around the z -axis. To do the rotations in the other order, multiply by RY . The matrices YR and RY are usually not the same, because doing the rotations in different orders will typically yield different results.
- (c) (i)

```
>> ph = pi/4;
>> P = [ cos(ph) 0 sin(ph); 0 1 0; -sin(ph) 0 cos(ph)] % Pitch.
P =
    0.7071         0    0.7071
         0    1.0000         0
   -0.7071         0    0.7071

>> al = -pi/3;
>> R = [ 1 0 0; 0 cos(al) -sin(al); 0 sin(al) cos(al)] % Roll.
R =
    1.0000         0         0
         0    0.5000    0.8660
         0   -0.8660    0.5000
```

```

>> th = pi/2;
>> Y = [ cos(th) -sin(th) 0; sin(th) cos(th) 0; 0 0 1] % The yaw matrix.
Y =
    0.0000   -1.0000         0
    1.0000    0.0000         0
         0         0    1.0000

>> A = eye(3) % Start with the standard basis for the attitude matrix.
A =
     1     0     0
     0     1     0
     0     0     1

>> A1 = Y*R*P*eye(3) % Do a pitch, roll and then yaw (reading right to left).
A1 =
    0.6124   -0.5000   -0.6124
    0.7071    0.0000    0.7071
   -0.3536   -0.8660    0.3536

```

(ii)

```

>> A2 = P*R*Y*eye(3) % Do a yaw, roll and then pitch. Compare with part (i).
A2 = % Results are different from A1.
   -0.6124   -0.7071    0.3536
    0.5000    0.0000    0.8660
   -0.6124    0.7071    0.3536

```

(iii) Repeat above with new th , $a1$, ph and (possibly) new orders.

(d)

```

>> p = [.2; .3; -1];
>> p2=(A2\A1)*p % Convert from first to second coordinate system.
p2 =
   -0.2221
   -0.8973
   -0.5250

>> ps = A1*p % Convert from the first coordinate system
>> % to the standard coordinate system.
ps =
    0.5848
   -0.5657
   -0.6841

>> A2*p2 % Convert from the second to standard
ans = % Same as ps above.
    0.5848
   -0.5657
   -0.6841

```

Section 4.9

1. Let $\mathbf{v}_1 = \begin{pmatrix} 1 \\ 1 \end{pmatrix}$ and $\mathbf{v}_2 = \begin{pmatrix} -1 \\ 1 \end{pmatrix}$. Then $\mathbf{u}_1 = \mathbf{v}_1/|\mathbf{v}_1| = \frac{1}{\sqrt{2}} \begin{pmatrix} 1 \\ 1 \end{pmatrix} = \begin{pmatrix} 1/\sqrt{2} \\ 1/\sqrt{2} \end{pmatrix}$, $\mathbf{v}'_2 = \mathbf{v}_2 - (\mathbf{v}_2 \cdot \mathbf{u}_1)\mathbf{u}_1 = \mathbf{v}_2 - (0)\mathbf{u}_1 = \mathbf{v}_2$, and hence $\mathbf{u}_2 = \mathbf{v}_2/|\mathbf{v}_2| = \begin{pmatrix} -1/\sqrt{2} \\ 1/\sqrt{2} \end{pmatrix}$.

2. A basis for H is $\{(1, -1)\}$. Thus an orthonormal basis for H is $\{(1/\sqrt{2}, -1/\sqrt{2})\}$.

3. (i) if $a = b = 0$, $\{(1, 0), (0, 1)\}$; (ii) if $a \neq 0$ and $b = 0$, $\{(0, 1)\}$; (iii) if $a = 0$ and $b \neq 0$, $\{(1, 0)\}$; (iv) if $a \neq 0$ and $b \neq 0$, $\{(b/\sqrt{a^2 + b^2}, -a/\sqrt{a^2 + b^2})\}$

4. Let $\mathbf{v}_1 = \begin{pmatrix} a \\ b \end{pmatrix}$ and $\mathbf{v}_2 = \begin{pmatrix} c \\ d \end{pmatrix}$. As $ad - bc \neq 0$, then $|\mathbf{v}_1| \neq 0$. Hence $\mathbf{u}_1 = \begin{pmatrix} a/\sqrt{a^2 + b^2} \\ b/\sqrt{a^2 + b^2} \end{pmatrix}$, $\mathbf{v}'_2 = \begin{pmatrix} c \\ d \end{pmatrix} - \frac{ac + bd}{\sqrt{a^2 + b^2}} \begin{pmatrix} a/\sqrt{a^2 + b^2} \\ b/\sqrt{a^2 + b^2} \end{pmatrix} = \begin{pmatrix} -b(ad - bc)/(a^2 + b^2) \\ a(ad - bc)/(a^2 + b^2) \end{pmatrix}$, $|\mathbf{v}'_2| = \frac{ad - bc}{\sqrt{a^2 + b^2}}$, and $\mathbf{u}_2 = \begin{pmatrix} -b/\sqrt{a^2 + b^2} \\ a/\sqrt{a^2 + b^2} \end{pmatrix}$.

5. A basis for π is $\left\{ \begin{pmatrix} 1 \\ 0 \\ 2 \end{pmatrix}, \begin{pmatrix} 0 \\ 1 \\ -1 \end{pmatrix} \right\}$. Hence $\mathbf{u}_1 = \begin{pmatrix} 1/\sqrt{5} \\ 0 \\ 2/\sqrt{5} \end{pmatrix}$, $\mathbf{v}'_2 = \begin{pmatrix} 0 \\ 1 \\ -1 \end{pmatrix} - (-2/\sqrt{5}) \begin{pmatrix} 1/\sqrt{5} \\ 0 \\ 2/\sqrt{5} \end{pmatrix} = \begin{pmatrix} 2/5 \\ 1 \\ -1/5 \end{pmatrix}$, and $\mathbf{u}_2 = \begin{pmatrix} 2/\sqrt{30} \\ 5/\sqrt{30} \\ -1/\sqrt{30} \end{pmatrix}$.

6. The set of vectors $\left\{ \begin{pmatrix} -2 \\ 0 \\ 1 \end{pmatrix}, \begin{pmatrix} 2/3 \\ 1 \\ 0 \end{pmatrix} \right\}$ forms a basis for π . Thus $\mathbf{u}_1 = \begin{pmatrix} -2/\sqrt{5} \\ 0 \\ 1/\sqrt{5} \end{pmatrix}$, $\mathbf{v}'_2 = \begin{pmatrix} 2/3 \\ 1 \\ 0 \end{pmatrix} - \frac{-4}{3\sqrt{5}} \begin{pmatrix} -2/\sqrt{5} \\ 0 \\ 1/\sqrt{5} \end{pmatrix} = \begin{pmatrix} 2/15 \\ 1 \\ 4/15 \end{pmatrix}$, and $\mathbf{u}_2 = \begin{pmatrix} 2\sqrt{5}/35 \\ 3\sqrt{5}/7 \\ 4\sqrt{5}/35 \end{pmatrix}$.

7. The vector $\begin{pmatrix} 2 \\ 3 \\ 4 \end{pmatrix}$ spans L , hence $\left\{ \begin{pmatrix} 2/\sqrt{29} \\ 3/\sqrt{29} \\ 4/\sqrt{29} \end{pmatrix} \right\}$ is an orthonormal basis for L .

8. As $(3, -2, 1)$ spans L , then $\{(3/\sqrt{14}, -2/\sqrt{14}, 1/\sqrt{14})\}$ is an orthonormal basis for L .

9. The vectors $\begin{pmatrix} 1 \\ 0 \\ 0 \\ 2 \end{pmatrix}$, $\begin{pmatrix} 0 \\ 1 \\ 0 \\ -1 \end{pmatrix}$, and $\begin{pmatrix} 0 \\ 0 \\ 1 \\ 3 \end{pmatrix}$ form a basis for H . So $\mathbf{u}_1 = \begin{pmatrix} 1/\sqrt{5} \\ 0 \\ 0 \\ 2/\sqrt{5} \end{pmatrix}$, $\mathbf{v}'_2 = \begin{pmatrix} 0 \\ 1 \\ 0 \\ -1 \end{pmatrix} - (-2/\sqrt{5}) \begin{pmatrix} 1/\sqrt{5} \\ 0 \\ 0 \\ 2/\sqrt{5} \end{pmatrix} = \begin{pmatrix} 2/5 \\ 1 \\ 0 \\ -1/5 \end{pmatrix}$, and $\mathbf{u}_2 = \begin{pmatrix} 2/\sqrt{30} \\ 5/\sqrt{30} \\ 0 \\ -1/\sqrt{30} \end{pmatrix}$. To find \mathbf{u}_3 we compute $\mathbf{v}'_3 =$

$$\mathbf{v}_3 - (\mathbf{v}_3 \cdot \mathbf{u}_1)\mathbf{u}_1 - (\mathbf{v}_3 \cdot \mathbf{u}_2)\mathbf{u}_2 = \begin{pmatrix} 0 \\ 0 \\ 1 \\ 3 \end{pmatrix} - (6/\sqrt{5}) \begin{pmatrix} 1/\sqrt{5} \\ 0 \\ 0 \\ 2/\sqrt{5} \end{pmatrix} - (-3/\sqrt{30}) \begin{pmatrix} 2/\sqrt{30} \\ 5/\sqrt{30} \\ 0 \\ -1/\sqrt{30} \end{pmatrix} = \begin{pmatrix} -1 \\ 1/2 \\ 1 \\ 1/2 \end{pmatrix}.$$

$$\text{Thus } \mathbf{u}_3 = \begin{pmatrix} -2/\sqrt{10} \\ 1/\sqrt{10} \\ 2/\sqrt{10} \\ 1/\sqrt{10} \end{pmatrix}$$

10. As $abc \neq 0$, then $a \neq 0$. Thus $\left\{ \begin{pmatrix} -b \\ a \\ 0 \end{pmatrix}, \begin{pmatrix} -c \\ 0 \\ a \end{pmatrix} \right\}$ is a basis for π . Then $\mathbf{u}_1 = \begin{pmatrix} -b/\sqrt{a^2+b^2} \\ a/\sqrt{a^2+b^2} \\ 0 \end{pmatrix}$,

$$\mathbf{v}'_2 = \begin{pmatrix} -c \\ 0 \\ a \end{pmatrix} - \frac{bc}{\sqrt{a^2+b^2}} \begin{pmatrix} -b/\sqrt{a^2+b^2} \\ a/\sqrt{a^2+b^2} \\ 0 \end{pmatrix} = \begin{pmatrix} -ca^2/(a^2+b^2) \\ -abc/a^2+b^2 \\ a \end{pmatrix}, \text{ and}$$

$$\mathbf{u}_2 = \begin{pmatrix} -ac\sqrt{(a^2+b^2)(a^2+b^2+c^2)} \\ -bc/\sqrt{(a^2+b^2)(a^2+b^2+c^2)} \\ (a^2+b^2)/\sqrt{(a^2+b^2)(a^2+b^2+c^2)} \end{pmatrix}$$

11. L is spanned by the vector $\begin{pmatrix} a \\ b \\ c \end{pmatrix}$. Hence $\left\{ \begin{pmatrix} a/\sqrt{a^2+b^2+c^2} \\ b/\sqrt{a^2+b^2+c^2} \\ c/\sqrt{a^2+b^2+c^2} \end{pmatrix} \right\}$ is an orthonormal basis for L .

12. The vectors $\begin{pmatrix} 1 \\ 0 \\ 0 \\ 2 \end{pmatrix}$, $\begin{pmatrix} 0 \\ 1 \\ 0 \\ -3 \end{pmatrix}$, $\begin{pmatrix} 0 \\ 0 \\ 1 \\ 1 \end{pmatrix}$, and $\begin{pmatrix} 0 \\ 0 \\ 0 \\ 4 \end{pmatrix}$ form a basis for H . Then $\mathbf{u}_1 = \begin{pmatrix} 1/\sqrt{5} \\ 0 \\ 0 \\ 2/\sqrt{5} \end{pmatrix}$, $\mathbf{v}'_2 =$

$$\begin{pmatrix} 0 \\ 1 \\ 0 \\ -3 \end{pmatrix} + \frac{6}{\sqrt{5}} \begin{pmatrix} 1/\sqrt{5} \\ 0 \\ 0 \\ 2/\sqrt{5} \end{pmatrix} \begin{pmatrix} 6/\sqrt{5} \\ 1 \\ 0 \\ -3/\sqrt{5} \end{pmatrix}, \mathbf{u}_2 = \begin{pmatrix} 6/\sqrt{70} \\ 5/\sqrt{70} \\ 0 \\ -3/\sqrt{70} \end{pmatrix}, \mathbf{v}'_3 = \begin{pmatrix} 0 \\ 0 \\ 1 \\ 0 \end{pmatrix} - \frac{2}{\sqrt{5}} \begin{pmatrix} 1/\sqrt{5} \\ 0 \\ 0 \\ 2/\sqrt{5} \end{pmatrix} + \frac{3}{\sqrt{70}} \begin{pmatrix} 6/\sqrt{70} \\ 5/\sqrt{70} \\ 0 \\ -3/\sqrt{70} \end{pmatrix} =$$

$$\begin{pmatrix} -1/7 \\ 3/14 \\ 1 \\ 0 \\ 1/14 \end{pmatrix} \text{ and } \mathbf{u}_3 = \begin{pmatrix} -2/\sqrt{210} \\ 3/\sqrt{210} \\ 14/\sqrt{210} \\ 0 \\ 1/\sqrt{210} \end{pmatrix}. \text{ To find } \mathbf{u}_4 \text{ we compute } \mathbf{v}'_4 = \mathbf{v}_4 - (\mathbf{v}_4 \cdot \mathbf{u}_1)\mathbf{u}_1 - (\mathbf{v}_4 \cdot \mathbf{u}_2)\mathbf{u}_2 -$$

$$(\mathbf{v}_4 \cdot \mathbf{u}_3)\mathbf{u}_3 = \begin{pmatrix} 0 \\ 0 \\ 0 \\ 1 \\ 4 \end{pmatrix} - \frac{8}{\sqrt{5}} \begin{pmatrix} 1/\sqrt{5} \\ 0 \\ 0 \\ 2/\sqrt{5} \end{pmatrix} + \frac{12}{\sqrt{70}} \begin{pmatrix} 6/\sqrt{70} \\ 5/\sqrt{70} \\ 0 \\ -3/\sqrt{70} \end{pmatrix} - \frac{4}{\sqrt{210}} \begin{pmatrix} -2/\sqrt{210} \\ 3/\sqrt{210} \\ 14/\sqrt{210} \\ 0 \\ 1/\sqrt{210} \end{pmatrix} = \begin{pmatrix} -8/15 \\ 4/5 \\ -4/15 \\ 1 \\ 4/15 \end{pmatrix}, \text{ and}$$

$$\text{hence } \mathbf{u}_4 = \begin{pmatrix} -8/\sqrt{465} \\ 12/\sqrt{465} \\ -4/\sqrt{465} \\ 15/\sqrt{465} \\ 4/\sqrt{465} \end{pmatrix}.$$

13. A basis for the solution space is $\left\{ \begin{pmatrix} 7 \\ 1 \\ -4 \end{pmatrix} \right\}$, and hence $\left\{ \begin{pmatrix} 7/\sqrt{66} \\ 1/\sqrt{66} \\ -4/\sqrt{66} \end{pmatrix} \right\}$ is an orthonormal basis.

14. The set of vectors $\left\{ \begin{pmatrix} 1/\sqrt{2} \\ 0 \\ 1/\sqrt{2} \\ 0 \end{pmatrix}, \begin{pmatrix} -1/2 \\ 1/2 \\ 1/2 \\ -1/2 \end{pmatrix}, \begin{pmatrix} 0 \\ 1 \\ 0 \\ 0 \end{pmatrix}, \begin{pmatrix} 0 \\ 0 \\ 0 \\ 1 \end{pmatrix} \right\}$ forms a basis for \mathbb{R}^4 . Then $\mathbf{v}'_3 = \begin{pmatrix} 0 \\ 1 \\ 0 \\ 0 \end{pmatrix} -$

$$0 \begin{pmatrix} 1/\sqrt{2} \\ 0 \\ 1/\sqrt{2} \\ 0 \end{pmatrix} - \frac{1}{2} \begin{pmatrix} -1/2 \\ 1/2 \\ 1/2 \\ -1/2 \end{pmatrix} = \begin{pmatrix} 1/4 \\ 3/4 \\ -1/4 \\ 1/4 \end{pmatrix}, \mathbf{u}_3 = \begin{pmatrix} 1/\sqrt{12} \\ 3/\sqrt{12} \\ -1/\sqrt{12} \\ 1/\sqrt{12} \end{pmatrix}, \mathbf{v}'_4 = \begin{pmatrix} 0 \\ 0 \\ 0 \\ 1 \end{pmatrix} - 0 \begin{pmatrix} 1/\sqrt{2} \\ 0 \\ 1/\sqrt{2} \\ 0 \end{pmatrix} + \frac{1}{2} \begin{pmatrix} -1/2 \\ 1/2 \\ 1/2 \\ -1/2 \end{pmatrix} -$$

$$\frac{1}{\sqrt{12}} \begin{pmatrix} 1/\sqrt{12} \\ 3/\sqrt{12} \\ -1/\sqrt{12} \\ 1/\sqrt{12} \end{pmatrix} = \begin{pmatrix} -1/3 \\ 0 \\ 1/3 \\ 2/3 \end{pmatrix}, \text{ and } \mathbf{u}_4 = \begin{pmatrix} -1/\sqrt{6} \\ 0 \\ 1/\sqrt{6} \\ 2/\sqrt{6} \end{pmatrix}$$

$$15. Q^t = \begin{pmatrix} 2/3 & 1/3 & -2/3 \\ 1/3 & 2/3 & 2/3 \\ 2/3 & -2/3 & 1/3 \end{pmatrix} \text{ and } QQ^t = I.$$

16. Since $PQ(PQ)^t = PQQ^tP^t = PIP^t = PP^t = I$ then PQ is orthogonal.

$$17. PQ(PQ)^t = \left(\frac{1}{3\sqrt{2}}\right)^2 \begin{pmatrix} 1-\sqrt{8} & -1-\sqrt{8} \\ 1+\sqrt{8} & 1-\sqrt{8} \end{pmatrix} \begin{pmatrix} 1-\sqrt{8} & 1+\sqrt{8} \\ -1-\sqrt{8} & 1-\sqrt{8} \end{pmatrix} = I.$$

18. As Q is symmetric and orthogonal, then $QQ^t = QQ = Q^2 = I$.

19. Since Q is orthogonal then $QQ^t = I$. Hence, $\det QQ^t = \det Q \det Q^t = (\det Q)^2 = 1$, which implies $\det Q = \pm 1$.

$$20. AA^t = A^2 = \begin{pmatrix} \sin t & \cos t \\ \cos t & -\sin t \end{pmatrix}^2 = \begin{pmatrix} 1 & 0 \\ 0 & 1 \end{pmatrix} \text{ for any real number } t.$$

21. If $\mathbf{v}_i = \mathbf{0}$, then let $c_i = 1$ and $c_j = 0$ for $j \neq i$. Then we will have $c_1\mathbf{v}_1 + c_2\mathbf{v}_2 + \cdots + c_n\mathbf{v}_n = \mathbf{0}$ with $c_i \neq 0$, which implies the set of vectors is linearly dependent.

22. (a) From problem 2, $\{(1/\sqrt{2}, -1/\sqrt{2})\}$ is an orthonormal basis for H . Thus

$$\text{proj}_H \mathbf{v} = \left(\begin{pmatrix} -1 \\ 2 \end{pmatrix} \cdot \begin{pmatrix} 1/\sqrt{2} \\ -1/\sqrt{2} \end{pmatrix} \right) \begin{pmatrix} 1/\sqrt{2} \\ -1/\sqrt{2} \end{pmatrix} = \begin{pmatrix} -3/2 \\ 3/2 \end{pmatrix}.$$

(b) $H^\perp = \{\mathbf{x} \in \mathbb{R}^2 : \mathbf{x} \cdot (1/\sqrt{2}, -1/\sqrt{2}) = 0\} = \{(x, y) \in \mathbb{R}^2 : x = y\} = \{(x, x) : x \in \mathbb{R}\}$. So an orthonormal basis for H^\perp is $\{(1/\sqrt{2}, 1/\sqrt{2})\}$.

$$(c) \mathbf{v} = \begin{pmatrix} -3/2 \\ 3/2 \end{pmatrix} + \left(\begin{pmatrix} -1 \\ 2 \end{pmatrix} \cdot \begin{pmatrix} 1/\sqrt{2} \\ 1/\sqrt{2} \end{pmatrix} \right) \begin{pmatrix} 1/\sqrt{2} \\ 1/\sqrt{2} \end{pmatrix} = \begin{pmatrix} -3/2 \\ 3/2 \end{pmatrix} + \begin{pmatrix} 1/2 \\ 1/2 \end{pmatrix}.$$

23. (a) If $a = b = 0$ then $\{(1, 0), (0, 1)\}$ is an orthonormal basis for H . So in this case $\text{proj}_H \mathbf{v} = \mathbf{v}$ by theorem 4. If either $a \neq 0$ or $b \neq 0$ then $\{(b/\sqrt{a^2 + b^2}, -a/\sqrt{a^2 + b^2})\}$ is an orthonormal basis for H , and $\text{proj}_H \mathbf{v} = \mathbf{0}$.

(b) For the case $a = b = 0$, $H^\perp = \{\mathbf{0}\}$ by part (iii) of theorem 6. If $a \neq 0$ or $b \neq 0$, then $H^\perp = \{\mathbf{x} \in \mathbb{R}^2 : \mathbf{x} \cdot (b, -a) = 0\} = \{t(a, b) : t \in \mathbb{R}\}$. Thus an orthonormal basis for H^\perp is $\{(a/\sqrt{a^2 + b^2}, b/\sqrt{a^2 + b^2})\}$.

(c) If $a = b = 0$, then $\mathbf{v} = \mathbf{v} + \mathbf{0}$. If $a \neq 0$ or $b \neq 0$, then $\mathbf{v} = \mathbf{0} + \mathbf{v}$.

$$24. (a) \text{ We may assume } a \neq 0. \text{ By problem 10, } \left\{ \begin{pmatrix} -b/\sqrt{a^2 + b^2} \\ a/\sqrt{a^2 + b^2} \\ 0 \end{pmatrix}, \begin{pmatrix} -ac/\sqrt{(a^2 + b^2)(a^2 + b^2 + c^2)} \\ -bc/\sqrt{(a^2 + b^2)(a^2 + b^2 + c^2)} \\ (a^2 + b^2)/\sqrt{(a^2 + b^2)(a^2 + b^2 + c^2)} \end{pmatrix} \right\}$$

is an orthonormal basis for H . So $\text{proj}_H \mathbf{v} = \mathbf{0} + \mathbf{0} = \mathbf{0}$.

(b) Upon solving the system $\mathbf{u}_1 \cdot \mathbf{x} = 0$, $\mathbf{u}_2 \cdot \mathbf{x} = 0$, we find $\{(a, b, c)\}$ is a basis for H^\perp , and hence $\{(a/\sqrt{a^2 + b^2 + c^2}, b/\sqrt{a^2 + b^2 + c^2}, c/\sqrt{a^2 + b^2 + c^2})\}$ is an orthonormal basis.

(c) $\mathbf{v} = \mathbf{0} + \mathbf{v}$.

$$25. (a) \text{ From problem 6 we have } \left\{ \begin{pmatrix} -2/\sqrt{5} \\ 0 \\ 1/\sqrt{5} \end{pmatrix}, \begin{pmatrix} 2/\sqrt{5}/35 \\ 3\sqrt{5}/7 \\ 4\sqrt{5}/35 \end{pmatrix} \right\} \text{ for an orthonormal basis of } H, \text{ and hence}$$

$$\text{proj}_H \mathbf{v} = 2\sqrt{5} \begin{pmatrix} -2/\sqrt{5} \\ 0 \\ 1/\sqrt{5} \end{pmatrix} + \frac{5\sqrt{5}}{7} \begin{pmatrix} 2\sqrt{5}/35 \\ 3\sqrt{5}/7 \\ 4\sqrt{5}/35 \end{pmatrix} = \begin{pmatrix} -186/49 \\ 75/49 \\ 118/49 \end{pmatrix}.$$

(b) Solving the system $\mathbf{u}_1 \cdot \mathbf{x} = 0$, $\mathbf{u}_2 \cdot \mathbf{x} = 0$ gives $\{(3, -2, 6)\}$ for a basis of H^\perp . So an orthonormal basis for H is $\{(3/7, -2/7, 6/7)\}$.

$$(c) \mathbf{v} = \begin{pmatrix} -186/49 \\ 75/49 \\ 118/49 \end{pmatrix} + \left(\begin{pmatrix} 3/7 \\ -2/7 \\ 6/7 \end{pmatrix} \cdot \begin{pmatrix} -3 \\ 1 \\ 4 \end{pmatrix} \right) \begin{pmatrix} 3/7 \\ -2/7 \\ 6/7 \end{pmatrix} = \begin{pmatrix} -186/49 \\ 75/49 \\ 118/49 \end{pmatrix} + \begin{pmatrix} 39/49 \\ -26/49 \\ 78/49 \end{pmatrix}.$$

26. (a) An orthonormal basis for H is $\{(2/\sqrt{29}, 3/\sqrt{29}, 4/\sqrt{29})\}$. So $\text{proj}_H \mathbf{v} = (18/29, 27/29, 36/29)$.

(b) Solving the system $\mathbf{u}_1 \cdot \mathbf{x} = 0$ gives $\left\{ \begin{pmatrix} -3 \\ 2 \\ 0 \end{pmatrix}, \begin{pmatrix} -2 \\ 0 \\ 1 \end{pmatrix} \right\}$ for a basis of H^\perp . Hence

$$\left\{ \begin{pmatrix} -3/\sqrt{13} \\ 2/\sqrt{13} \\ 0 \end{pmatrix}, \begin{pmatrix} -8/\sqrt{377} \\ -12/\sqrt{377} \\ 13/\sqrt{377} \end{pmatrix} \right\} \text{ is an orthonormal basis for } H^\perp.$$

$$(c) \mathbf{v} = \begin{pmatrix} 18/29 \\ 27/29 \\ 36/29 \end{pmatrix} - \frac{1}{\sqrt{13}} \begin{pmatrix} -3/\sqrt{13} \\ 2/\sqrt{13} \\ 0 \end{pmatrix} - \frac{7}{\sqrt{377}} \begin{pmatrix} -8/\sqrt{377} \\ -12/\sqrt{377} \\ 13/\sqrt{377} \end{pmatrix} = \begin{pmatrix} 18/29 \\ 27/29 \\ 36/29 \end{pmatrix} + \begin{pmatrix} 11/29 \\ 2/29 \\ -7/29 \end{pmatrix}.$$

27. (a) From problem 9, the set of vectors $\left\{ \begin{pmatrix} 1/\sqrt{5} \\ 0 \\ 0 \\ 2/\sqrt{5} \end{pmatrix}, \begin{pmatrix} 2/\sqrt{30} \\ 5/\sqrt{30} \\ 0 \\ -1/\sqrt{30} \end{pmatrix}, \begin{pmatrix} -2/\sqrt{10} \\ 1/\sqrt{10} \\ 2/\sqrt{10} \\ 1/\sqrt{10} \end{pmatrix} \right\}$ forms an orthonormal

$$\text{basis for } H. \text{ Hence } \text{proj}_H \mathbf{v} = \frac{7}{\sqrt{5}} \begin{pmatrix} 1/\sqrt{5} \\ 0 \\ 0 \\ 2/\sqrt{5} \end{pmatrix} - \frac{6}{\sqrt{30}} \begin{pmatrix} 2/\sqrt{30} \\ 5/\sqrt{30} \\ 0 \\ -1/\sqrt{30} \end{pmatrix} + \frac{4}{\sqrt{10}} \begin{pmatrix} -2/\sqrt{10} \\ 1/\sqrt{10} \\ 2/\sqrt{10} \\ 1/\sqrt{10} \end{pmatrix} = \begin{pmatrix} 1/5 \\ -3/5 \\ 4/5 \\ 17/5 \end{pmatrix}.$$

(b) Upon solving the system $\mathbf{u}_i \cdot \mathbf{x} = 0$, we find $\{(-2/\sqrt{15}, 1/\sqrt{15}, -3/\sqrt{15}, 1/\sqrt{15})\}$ is an orthonormal basis for H^\perp .

$$(c) \mathbf{v} = \begin{pmatrix} 1/5 \\ -3/5 \\ 4/5 \\ 17/5 \end{pmatrix} - \frac{6}{\sqrt{15}} \begin{pmatrix} -2/\sqrt{15} \\ 1/\sqrt{15} \\ -3/\sqrt{15} \\ 1/\sqrt{15} \end{pmatrix} = \begin{pmatrix} 1/5 \\ -3/5 \\ 4/5 \\ 17/5 \end{pmatrix} + \begin{pmatrix} 4/5 \\ -2/5 \\ 6/5 \\ -2/5 \end{pmatrix}.$$

28. (a) The set of vectors $\left\{ \begin{pmatrix} 0 \\ 0 \\ 1 \\ 0 \end{pmatrix}, \begin{pmatrix} 1 \\ 1 \\ 0 \\ 3 \end{pmatrix} \right\}$ forms a basis for H , and hence $\left\{ \begin{pmatrix} 0 \\ 0 \\ 1 \\ 0 \end{pmatrix}, \begin{pmatrix} 1/\sqrt{11} \\ 1/\sqrt{11} \\ 0 \\ 3/\sqrt{11} \end{pmatrix} \right\}$ is an

$$\text{orthonormal basis. So } \text{proj}_H \mathbf{v} = \begin{pmatrix} 0 \\ 0 \\ 3 \\ 0 \end{pmatrix} + \begin{pmatrix} 4/11 \\ 4/11 \\ 0 \\ 12/11 \end{pmatrix} = \begin{pmatrix} 4/11 \\ 4/11 \\ 3 \\ 12/11 \end{pmatrix}.$$

(b) Solving the system $\mathbf{u}_i \cdot \mathbf{x} = 0$ gives $\left\{ \begin{pmatrix} -1 \\ 1 \\ 0 \\ 0 \end{pmatrix}, \begin{pmatrix} -3 \\ 0 \\ 0 \\ 1 \end{pmatrix} \right\}$ for a basis of H . So

$$\left\{ \begin{pmatrix} -1/\sqrt{2} \\ 1/\sqrt{2} \\ 0 \\ 0 \end{pmatrix}, \begin{pmatrix} -3/\sqrt{22} \\ -3/\sqrt{33} \\ 0 \\ 2/\sqrt{22} \end{pmatrix} \right\} \text{ is an orthonormal basis for } H.$$

$$(c) \mathbf{v} = \begin{pmatrix} 4/11 \\ 4/11 \\ 3 \\ 12/11 \end{pmatrix} + \begin{pmatrix} -3/2 \\ 3/2 \\ 0 \\ 0 \end{pmatrix} + \begin{pmatrix} 3/22 \\ 3/22 \\ 0 \\ -1/11 \end{pmatrix} = \begin{pmatrix} 4/11 \\ 4/11 \\ 3 \\ 12/11 \end{pmatrix} + \begin{pmatrix} -15/11 \\ 18/11 \\ 0 \\ -1/11 \end{pmatrix}.$$

29. $|\mathbf{u}_1 - \mathbf{u}_2|^2 = (\mathbf{u}_1 - \mathbf{u}_2) \cdot (\mathbf{u}_1 - \mathbf{u}_2) = |\mathbf{u}_1|^2 - 2\mathbf{u}_1 \cdot \mathbf{u}_2 + |\mathbf{u}_2|^2 = 1 + 0 + 1 = 2$. So $|\mathbf{u}_1 - \mathbf{u}_2| = \sqrt{2}$.
30. Use induction on n . If $n = 1$, then $|\mathbf{u}_1|^2 = 1$. Suppose $|\mathbf{u}_1 + \mathbf{u}_2 + \cdots + \mathbf{u}_{n-1}|^2 = n - 1$. Then $|\mathbf{u}_1 + \mathbf{u}_2 + \cdots + \mathbf{u}_n|^2 = (\mathbf{u}_1 + \mathbf{u}_2 + \cdots + \mathbf{u}_n) \cdot (\mathbf{u}_1 + \mathbf{u}_2 + \cdots + \mathbf{u}_n) = \mathbf{u}_n \cdot (\mathbf{u}_1 + \mathbf{u}_2 + \cdots + \mathbf{u}_n) + (\mathbf{u}_1 + \mathbf{u}_2 + \cdots + \mathbf{u}_{n-1}) \cdot (\mathbf{u}_1 + \mathbf{u}_2 + \cdots + \mathbf{u}_n) = 2\mathbf{u}_n \cdot (\mathbf{u}_1 + \mathbf{u}_2 + \cdots + \mathbf{u}_{n-1}) + \mathbf{u}_n \cdot \mathbf{u}_n + (\mathbf{u}_1 + \mathbf{u}_2 + \cdots + \mathbf{u}_{n-1}) \cdot (\mathbf{u}_1 + \mathbf{u}_2 + \cdots + \mathbf{u}_{n-1}) = 0 + 1 + n - 1 = n$. By induction, this proves the result.
31. For linear independence we want $a^2 + b^2 \neq 0$. For the vectors to form an orthonormal basis we need $a^2 + b^2 = 1$.
32. Suppose $\left\{ \begin{pmatrix} a \\ b \end{pmatrix}, \begin{pmatrix} c \\ d \end{pmatrix} \right\}$ is an orthonormal basis for \mathbb{R}^2 . Then $a^2 + b^2 = c^2 + d^2 = 1$, and $ac + bd = 0$. We may assume $a \neq 0$. So $c = -bd/a$. Substituting this into $c^2 + d^2 = 1$ and solving for d gives $d = \pm a$. Thus, $\begin{pmatrix} c \\ d \end{pmatrix} = \begin{pmatrix} b \\ -a \end{pmatrix}$ or $\begin{pmatrix} c \\ d \end{pmatrix} = \begin{pmatrix} -b \\ a \end{pmatrix}$.
33. Suppose $|\mathbf{u} + \mathbf{v}| = |\mathbf{u}| + |\mathbf{v}|$. Then $|\mathbf{u} + \mathbf{v}|^2 = (\mathbf{u} + \mathbf{v}) \cdot (\mathbf{u} + \mathbf{v}) = |\mathbf{u}|^2 + 2(\mathbf{u} \cdot \mathbf{v}) + |\mathbf{v}|^2 = |\mathbf{u}|^2 + 2|\mathbf{u}||\mathbf{v}| + |\mathbf{v}|^2$. Thus $\mathbf{u} \cdot \mathbf{v} = |\mathbf{u}||\mathbf{v}|$, which implies $\mathbf{u} = \lambda\mathbf{v}$ for some scalar λ , and hence \mathbf{u} and \mathbf{v} are linearly dependent.
34. $|\mathbf{u} + \mathbf{v}|^2 = |\mathbf{u}|^2 + 2(\mathbf{u} \cdot \mathbf{v}) + |\mathbf{v}|^2 \leq |\mathbf{u}|^2 + 2|\mathbf{u}||\mathbf{v}| + |\mathbf{v}|^2 = (|\mathbf{u}| + |\mathbf{v}|)^2$. Taking square roots, we obtain $|\mathbf{u} + \mathbf{v}| \leq |\mathbf{u}| + |\mathbf{v}|$.
35. Use induction on n . For the case $n = 1$, we have $\mathbf{x}_1 \neq 0$, so $\dim \text{span}\{\mathbf{x}_1\} = 1$. Assume the result is true for $k = n$. Suppose that

$$|\mathbf{x}_1 + \mathbf{x}_2 + \cdots + \mathbf{x}_{n+1}| = |\mathbf{x}_1| + |\mathbf{x}_2| + \cdots + |\mathbf{x}_{n+1}|. \quad (*)$$

We want to show $|\mathbf{x}_1 + \mathbf{x}_2 + \cdots + \mathbf{x}_n| = |\mathbf{x}_1| + |\mathbf{x}_2| + \cdots + |\mathbf{x}_n|$. If we do not have equality, then by the triangle inequality, $|\mathbf{x}_1 + \mathbf{x}_2 + \cdots + \mathbf{x}_n| < |\mathbf{x}_1| + |\mathbf{x}_2| + \cdots + |\mathbf{x}_n|$. But adding $|\mathbf{x}_{n+1}|$ to both sides would give $|\mathbf{x}_1 + \mathbf{x}_2 + \cdots + \mathbf{x}_{n+1}| < |\mathbf{x}_1| + |\mathbf{x}_2| + \cdots + |\mathbf{x}_{n+1}|$, which contradicts (*). Thus, we have equality and hence, $\dim \text{span}\{\mathbf{x}_1, \mathbf{x}_2, \dots, \mathbf{x}_n\} = 1$ by the induction hypothesis. As $|\mathbf{x}_1 + \mathbf{x}_2 + \cdots + \mathbf{x}_{n+1}| = |\mathbf{x}_1 + \mathbf{x}_2 + \cdots + \mathbf{x}_n| + |\mathbf{x}_{n+1}|$, then by problem #33, we have $\mathbf{x}_{n+1} = \lambda(\mathbf{x}_1 + \mathbf{x}_2 + \cdots + \mathbf{x}_n)$. So $\mathbf{x}_{n+1} \in \text{span}\{\mathbf{x}_1, \mathbf{x}_2, \dots, \mathbf{x}_n\}$, and hence $\dim \text{span}\{\mathbf{x}_1, \mathbf{x}_2, \dots, \mathbf{x}_{n+1}\} = 1$, which proves the result.

36. By theorem 4 we have $\mathbf{v} = (\mathbf{v} \cdot \mathbf{u}_1)\mathbf{u}_1 + (\mathbf{v} \cdot \mathbf{u}_2)\mathbf{u}_2 + \cdots + (\mathbf{v} \cdot \mathbf{u}_n)\mathbf{u}_n$. Hence,

$$\begin{aligned} |\mathbf{v}|^2 &= \mathbf{v} \cdot \mathbf{v} = [(\mathbf{v} \cdot \mathbf{u}_1)\mathbf{u}_1 + \cdots + (\mathbf{v} \cdot \mathbf{u}_n)\mathbf{u}_n] \cdot [(\mathbf{v} \cdot \mathbf{u}_1)\mathbf{u}_1 + \cdots + (\mathbf{v} \cdot \mathbf{u}_n)\mathbf{u}_n] \\ &= (\mathbf{v} \cdot \mathbf{u}_1)^2(\mathbf{u}_1 \cdot \mathbf{u}_1) + (\mathbf{v} \cdot \mathbf{u}_2)^2(\mathbf{u}_2 \cdot \mathbf{u}_2) + \cdots + (\mathbf{v} \cdot \mathbf{u}_n)^2(\mathbf{u}_n \cdot \mathbf{u}_n), \text{ since } \mathbf{u}_i \cdot \mathbf{u}_j = 0, i \neq j \\ &= |\mathbf{v} \cdot \mathbf{u}_1|^2 + |\mathbf{v} \cdot \mathbf{u}_2|^2 + \cdots + |\mathbf{v} \cdot \mathbf{u}_n|^2, \text{ since } \mathbf{u}_i \cdot \mathbf{u}_i = 1. \end{aligned}$$

37. Let $\mathbf{v} \in H$. Then for every $\mathbf{k} \in H^\perp$, we have $\mathbf{v} \cdot \mathbf{k} = 0$. Thus $\mathbf{v} \in (H^\perp)^\perp$, which shows $H \subseteq (H^\perp)^\perp$. Suppose $\mathbf{v} \in (H^\perp)^\perp$. Then $\mathbf{v} \cdot \mathbf{k} = 0$ for every $\mathbf{k} \in H^\perp$. By theorem 7, there exists $\mathbf{h} \in H$ and $\mathbf{p} \in H^\perp$ such that $\mathbf{v} = \mathbf{h} + \mathbf{p}$. Thus $\mathbf{v} \cdot \mathbf{p} = 0 = \mathbf{h} \cdot \mathbf{p} + \mathbf{p} \cdot \mathbf{p} = \mathbf{p} \cdot \mathbf{p}$, which implies $\mathbf{p} = 0$. So $\mathbf{v} \in H$, and hence $(H^\perp)^\perp \subseteq H$. Therefore $H = (H^\perp)^\perp$.
38. Let $\mathbf{v} \in H_1$. By theorem 7, there exists $\mathbf{h} \in H_2$ and $\mathbf{p} \in H_2^\perp$ such that $\mathbf{v} = \mathbf{h} + \mathbf{p}$. As $H_1^\perp = H_2^\perp$, then for every $\mathbf{k} \in H_2^\perp$ we have $\mathbf{v} \cdot \mathbf{k} = 0$. In particular, $\mathbf{v} \cdot \mathbf{p} = 0 = \mathbf{h} \cdot \mathbf{p} + \mathbf{p} \cdot \mathbf{p} = \mathbf{p} \cdot \mathbf{p}$, and hence $\mathbf{p} = 0$. So $\mathbf{v} \in H_2$, which shows $H_1 = H_2$.
39. Let $\mathbf{h} \in H_2^\perp$. Then $\mathbf{h} \cdot \mathbf{v} = 0$ for every $\mathbf{v} \in H_2$. As $H_1 \subset H_2$, then $\mathbf{h} \cdot \mathbf{v} = 0$ for every $\mathbf{v} \in H_1$. Thus $\mathbf{h} \in H_1^\perp$. Therefore $H_2^\perp \subset H_1^\perp$.
40. As $\mathbf{u} \perp \mathbf{v}$, then $\mathbf{u} \cdot \mathbf{v} = 0$. Thus, $|\mathbf{u} + \mathbf{v}|^2 = (\mathbf{u} + \mathbf{v}) \cdot (\mathbf{u} + \mathbf{v}) = |\mathbf{u}|^2 + 2(\mathbf{u} \cdot \mathbf{v}) + |\mathbf{v}|^2 = |\mathbf{u}|^2 + |\mathbf{v}|^2$.

MATLAB 4.9

1. (a)

```

>> v1 = [-1; 2; -1]; v2 = [3; 4; 0];
>> u1 = v1 / norm(v1) % Normalize v1.
u1 =
   -0.4082
    0.8165
   -0.4082
>> u2 = u2 - ((v2'*u1)/(u1'*u1))*u1 % orthogonalize, could omit
u2 = % denominator (u1'*u1) as u1 length 1.
    3.8333
    2.3333
    0.8333
>> u2 = u2 / norm(u2) % normalize.
u2 =
    0.8398
    0.5112
    0.1826
>> A = [u1 u2]; % This is the matrix of vectors.
>> A'*A % Dot each column in A with every other column in A, all at once.
% If this is the identity, then the vectors are orthonormal.
ans =
    1.0000    0.0000
    0.0000    1.0000

```

Check $\text{rref}([A: v1 v2])=[I:c1 c2]$ to verify $v1, v2$ are combinations of $u1, u2$.

(b)

```

>> v1 = [0 -2 -3 -3 1]';
>> v2 = [3 -5 0 0 5]'; v3 = [2 1 4 1 3]';
>> u1 = v1 / norm(v1) % Normalize v1.
u1 =
    0
   -0.4170
   -0.6255
   -0.6255
    0.2085
>> u2 = v2 - (v2'*u1)*u1 % orthogonalize.
u2 =
    3.0000
   -3.6957
    1.9565
    1.9565
    4.3478
>> u2 = u2 / norm(u2) % normalize.
u2 =
    0.4276
   -0.5268
    0.2789
    0.2789
    0.6197

```

```

>> u3 = u3 - (v3'*u1)*u1 - (v3'*u2)*u2
u3 =
    0.4682
    1.6696
    1.1749
   -1.8251
    1.3887

>> u3 = u3 / norm(u3)
u3 =
    0.1507
    0.5376
    0.3783
   -0.5876
    0.4471

>> A = [u1 u2 u3];           % This is the matrix of vectors.
>> A'*A % Dot each column in A with every other column in A.
      % If this is the identity, then the vectors are orthonormal.

ans =
    1.0000    0.0000    0.0000
    0.0000    1.0000    0.0000
    0.0000    0.0000    1.0000

```

Check `rref([A v1 v2 v3])` is `[I c1 c2 c3]` to verify v_i 's are linear combinations of u_i 's.

(c)

```

>> v1 = [-1; 2; 0; 1]; v2 = [1; -1; 2; 2];
>> v3 = [1; -2; 3; 1]; v4 = [-1; 2; -1; 4];
>> u1 = v1 / norm(v1)           % Normalize u1.
u1 =
   -0.4082
    0.8165
     0
    0.4082

>> u2 = v2 - (v2'*u1)*u1 % orthogonalize.
u2 =
    0.8333
   -0.6667
    2.0000
    2.1667

>> u2 = u2 / norm(u2)           % normalize.
u2 =
    0.2657
   -0.2126
    0.6378
    0.6909

>> u3 = v3 - (v3'*u1)*u1 - (v3'*u2)*u2
u3 =
   -0.5424
    0.0339
    0.8983
   -0.6102

```

```

>> u3 = u3 / norm(u3)
u3 =
    -0.4466
     0.0279
     0.7398
    -0.5025

>> u4 = v4 - (v4'*u1)*u1 - (v4'*u2)*u2 - (v4'*u3)*u3
u4 =
    -0.8851
    -0.6322
    -0.2529
     0.3793

>> u4 = u4 / norm(u4)
u4 =
    -0.7505
    -0.5361
    -0.2144
     0.3216

>> A = [u1 u2 u3 u4]; % This is the matrix of vectors.
>> A'*A % Dot each column in A with every other column in A.
      % If this is the identity, then the vectors are orthonormal.
ans =
    1.0000    0.0000    0.0000    0.0000
    0.0000    1.0000    0.0000    0.0000
    0.0000    0.0000    1.0000    0.0000
    0.0000    0.0000    0.0000    1.0000

```

(d) Repeat above with 4 random vectors.

2. The solution set for $Ax = 0$ has $x = 1y - 3z - 1w$ with the other variables arbitrary. So a basis for H will be:

```

>> v1 = [1; 1; 0; 0]; % y = 1, z = w = 0;
>> v2 = [-3; 0; 1; 0]; % z = 1, y = w = 0;
>> v3 = [-1; 0; 0; 1]; % w = 1, y = z = 0;
>> u1 = v1 / norm(v1) % Perform Gram-Schmidt.
u1 =
    0.7071
    0.7071
     0
     0

>> u2 = v2 - (v2'*u1)*u1
u2 =
   -1.5000
    1.5000
    1.0000
     0

>> u2 = u2 / norm(u2)
u2 =
   -0.6396
    0.6396
    0.4264
     0

```

```

>> u3 = v3 - (v3'*u1)*u1 - (v3'*u2)*u2
u3 =
   -0.0909
    0.0909
   -0.2727
    1.0000

>> u3 = u3 / norm(u3)
u3 =
   -0.0870
    0.0870
   -0.2611
    0.9574

>> A = [u1 u2 u3]           % The final basis.
A =
    0.7071   -0.6396   -0.0870
    0.7071    0.6396    0.0870
         0    0.4264   -0.2611
         0         0    0.9574

```

3. (a) Let $l = \sqrt{a^2 + b^2}$, which is the $|v|$ and $|z|$. Then $v_1 \cdot v_2 = (-ab + ba)/l^2 = 0$. Also, $|v_1| = |v|/l = l/l = 1$, and $|v_2| = |z|/l = l/l = 1$. Hence the set is orthonormal. Since this is an orthogonal set of nonzero vectors, it is linearly independent. Any set of two linearly independent vectors is a basis for \mathbb{R}^2 .

(b)

```

>> v = [1; 2];
>> v1 = v / norm(v), v2 = [-2; 1]/norm(v)
v1 =
    0.4472
    0.8944
v2 =
   -0.8944
    0.4472

>> w = [-3; 4];
>> p1 = (w'*v1)*v1           % Notice that v1'*v1 = 1.
p1 =
     1
     2

>> p2 = (w'*v2)*v2           % Notice that v2'*v2 = 1.
p2 =
    -4
     2

>> prjtn(w,v1); print -deps fig493b1.eps
>> prjtn(w,v2); print -deps fig493b2.eps

```

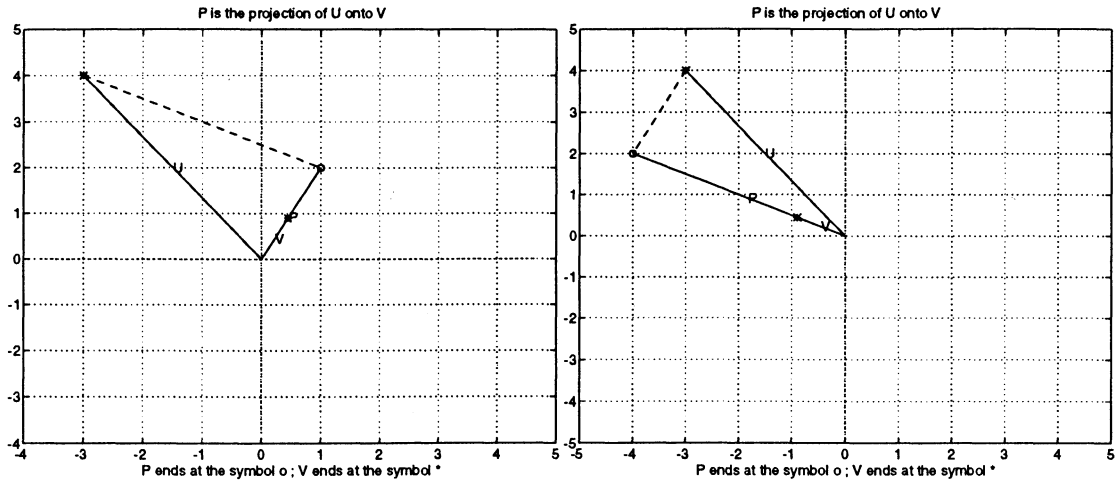

(c)

```
>> p1 + p2                                % This should be w.
ans =
    -3
     4
>> lincomb(v1,v2,w); print -deps fig493c.eps ;
```

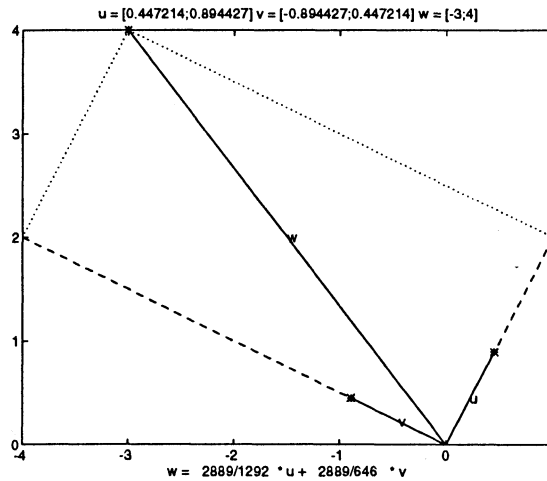

Note that in the `prjtn` graphs the projection onto a vector is formed by dropping a perpendicular onto the vector. Then in the `lincomb` graph the parallelogram formed is a rectangle since v_1, v_2 are perpendicular.

(d)

```
>> w = [4; 2];
>> p1 = (w'*v1)*v1                        % Notice that v1'*v1 = 1.
p1 =
    1.6000
    3.2000

>> p2 = (w'*v2)*v2                        % Notice that v1'*v1 = 1.
p2 =
    2.4000
   -1.2000
```

```
>> p1 + p2 % This should be w.
ans =
    4.0000
    2.0000
```

- (e) Your choice.
- (f) Using H as the span of $\{v = av_1\}$, p_1 is in H and p_2 is in H^\perp since $v_2 \cdot v_1 = 0$, and $w = p_1 + p_2$.

4. (a)

```
>> v = [2; 1]/ norm([2;1])
v =
    0.8944
    0.4472

>> w = [3; 5];
>> p = (w'*v)*v
p =
    4.4000
    2.2000

>> norm(w-p) % the distance from w to p.
ans =
    3.1305
```

(b)

```
>> c = 2.5;
>> z = c*v;
>> norm(w-z) % This should be larger than |w-p|.

ans =
    3.9564
```

(c)

```
>> w = [-3; 2];
>> p = (w'*v)*v
p =
   -1.6000
   -0.8000

>> norm(w-p) % the distance from w to p.
ans =
    3.1305

>> c = 1.5;
>> z = c*v;
>> norm(w-z) % This should be larger than |w-p|.

ans =
    4.5405
```

- (e) Label p at foot of perpendicular dropped from w to line through v , $w - p$ is this perpendicular, and $w - z$ is the dashed hypotenuse. The diagrams show that if $z = \alpha v$ in $H = \text{span}\{v\}$ is not $\text{proj}_H w = p$ then $w - z$ is the hypotenuse of a right triangle with one side $w - p$. Hence $|w - p| < |w - z|$.

5. (a)

```
>> v1 = [-1; 2; 3]; v2 = [0; 1; 2];
>> z1 = v1/norm(v1)
z1 =
    -0.2673
     0.5345
     0.8018
>> z2 = v2 - (v2'*z1)*z1;
>> z2 = z2/norm(z2)
z2 =
     0.8729
    -0.2182
     0.4364
```

(b)

```
>> z = [-1; -2; 1];
>> z'*v1, z'*v2
ans =
     0
ans =
     0
```

Since H is a two dimensional subspace of \mathbb{R}^3 , H^\perp will be one dimensional ($3 - 2 = 1$). Since z is a nonzero vector in H^\perp , it will form a basis. The vector n is the result of using Gram-Schmidt on the basis $\{z\}$.

(c)

```
>> n = z/norm(z);
>> w = [1; 0; 0]; % Choose a vector.
>> wh1 = (w'*z1)*z1 + (w'*z2)*z2 % Use method 1.
wh1 =
     0.8333
    -0.3333
     0.1667
>> wh2 = w - (w'*n)*n % Use method 2. (should be the same as 1.)
wh2 =
     0.8333
    -0.3333
     0.1667
```

(d) To get h drop a perpendicular from w to line through n . $w - h$ can be represented as the arrow from h to w , which is the side of a parallelogram opposite to p , the projection of w .

6. (a)

```
>> u1 = [0; -2; -3; -3; 1];
>> u2 = [3; -5; 0; 0; 5]; u3 = [2; 1; 4; 1; 3];
>> A = [u1 u2 u3]; B = orth(A)
B =
     0.3906     0.2298     0.0157
    -0.6509     0.4563     0.3293
         0     0.7747    -0.1098
         0     0.1937    -0.8814
     0.6509     0.3184     0.3199
```



```
>> B'*B                                % Verify that the columns are orthonormal.
ans =
    1.0000    0.0000    0.0000
    0.0000    1.0000    0.0000
    0.0000    0.0000    1.0000
```

(b)

```
>> x = round(10*(2*rand(3,1)-1));
```

Recall that Ax is a linear combination of the columns of A , so it is in the range of A . To verify Theorem 4, we use the columns of B as the orthonormal basis.

```
>> w = A*x                              % This and the next display should be the same:
w =
   -11
   -27
   -43
   -13
   -14

>> (w'*B(:,1))*B(:,1) + (w'*B(:,2))*B(:,2) + (w'*B(:,3))*B(:,3)
ans =
  -11.0000
  -27.0000
  -43.0000
  -13.0000
  -14.0000
```

7.

```
>> A = 10*(2*rand(6,4)-1);
>> B = orth(A)
B =
    0.1746    0.2858   -0.6351    0.2796
    0.4137    0.4925   -0.0476    0.4788
    0.0167   -0.5723   -0.0451    0.4736
   -0.4933    0.5789    0.3622    0.0574
   -0.5076    0.0353   -0.6763   -0.2394
    0.5451    0.1089   -0.0611   -0.6385
```

(a)

```
>> w = 10*(2*rand(6,1)-1)
w =
   -4.4584
    8.2763
    0.5949
   -0.7111
    8.8196
   -8.9983
```

```

>> c = w'*B           % The dot product of w with each column in B.
c =                  % (w'*u1 w'*u2 w'*u3 w'*u4)
   -6.3757    1.3810   -3.2613    6.5911
>> z = c'
z =                  % So z=(w'*u1 w'*u2 w'*u3 w'*u4)'=B'*w
   -6.3757
    1.3810
   -3.2613
    6.5911

>> p = B*z           % The projection of w onto H is
p =                  % (w.u1)u1+(w.u2)u2+(w.u3)u3+(w.u4)u4
    3.1961           % Note p=B*B'*w combining previous steps
    1.3539
    2.3712
    3.1414
    3.9128
   -7.3338

```

(b)

```

>> x = 10*(2*rand(4,1)-1);
>> h = A*x           % h is in H.
h =
   49.1183
   19.2271
  -38.5432
   80.7957
   80.5036
  -54.4691

>> norm(w-h), norm(w-p) % Compare.
ans =
   135.5423
ans =
   12.3026

```

The distance from w to $\text{proj}_H w$ is always smaller (or equal to) the distance from w to h , any arbitrary vector in H .

(c) Since v_4 is a linear combination of v_1 , v_3 and z , it may be replaced by z in the basis for H .

```

>> z = A * [ 2; 0; -3; 1];
>> C = [ A(:, [1:3]) z]; D = orth(C);
>> w = 10*(2*rand(6,1)-1);
>> p1 = B*B'*w;      % Use basis B. We learned in (a) this is projection
>> p2 = D*D'*w;      % Use basis D.
>> p1 - p2           % Compare. Get zero up to round off error.
ans =
   1.0e-14 *
    0.6661
   -0.0888
   -0.1776
    0.4441
   -0.1776
   -0.3109

```

The projection of \mathbf{w} onto H does not depend on which basis you choose. Here, $\mathbf{p}_1 - \mathbf{p}_2$ has some small round off error.

- (d) The entries in $B^t \mathbf{w}$ are the coefficients in definition 4 since $\mathbf{u}_i \cdot \mathbf{w} = \mathbf{u}_i^t * \mathbf{w}$. To form the linear combination of the columns of B with these as multipliers, as in definition 4, form $B(B^t \mathbf{w})$.
8. (a) If a vector \mathbf{v} is in the null space of A^t , then $A^t \mathbf{v} = \mathbf{0}$. By taking the transpose of this we may replace it by $\mathbf{v}^t A = \mathbf{0}$. Since any thing in H can be written as $A\mathbf{x}$ for some \mathbf{x} , we have that $\mathbf{v}^t(A\mathbf{x}) = (\mathbf{v}^t A)\mathbf{x} = \mathbf{0}\mathbf{x} = \mathbf{0}$. This means that \mathbf{v} is orthogonal to anything in H or that $\mathbf{v} \in H^\perp$. Conversely, if $\mathbf{v} \in H^\perp$, we have that for any vector $\mathbf{y} \in H$, $\mathbf{v}^t \mathbf{y} = 0$. For any vector \mathbf{x} in the domain of A , $A\mathbf{x}$ is in H , so we have $\mathbf{v}^t A\mathbf{x} = 0$, or by taking the transpose $\mathbf{x}^t(A^t \mathbf{v}) = 0$. This means that $A^t \mathbf{v}$ is orthogonal to every vector \mathbf{x} . This can happen only when $A^t \mathbf{v} = \mathbf{0}$, hence \mathbf{v} is in the null space of A^t .
- (b)

```
>> A = round(10*(2*rand(7,4)-1));
>> B = orth(A); C = null(A');
>> C'*C % Verify that columns of C are orthonormal.
ans =
    1.0000    0.0000    0.0000
    0.0000    1.0000    0.0000
    0.0000    0.0000    1.0000
```

(c)

```
>> w = round(10*(2*rand(7,1)-1));
>> h = B*B'*w; p = C*C'*w;
>> w - (h+p) % This should be zero (up to round off error).
ans =
    1.0e-14 *
    0.1776
   -0.4441
    0.5329
    0.0444
   -0.1776
    0.0888
   -0.0888

>> h'*p % h,p should be (essentially) orthogonal.
ans =
   -5.3291e-15
```

(d)

```
>> B*B' + C*C' % This should be I.
ans =
    1.0000    0.0000    0.0000    0.0000    0.0000    0.0000    0.0000
    0.0000    1.0000    0.0000    0.0000    0.0000    0.0000    0.0000
    0.0000    0.0000    1.0000    0.0000    0.0000    0.0000    0.0000
    0.0000    0.0000    0.0000    1.0000    0.0000    0.0000    0.0000
    0.0000    0.0000    0.0000    0.0000    1.0000    0.0000    0
    0.0000    0.0000    0.0000    0.0000    0.0000    1.0000    0.0000
    0.0000    0.0000    0.0000    0.0000    0          0.0000    1.0000
```

- (e) Since $\mathbf{h} = BB^t \mathbf{w}$ and $\mathbf{p} = CC^t \mathbf{w}$, and since $\mathbf{w} = \mathbf{h} + \mathbf{p}$, we have that $\mathbf{w} = (BB^t + CC^t)\mathbf{w}$. Since this is true for every vector \mathbf{w} , it follows that $I = BB^t + CC^t$.

9. (a) The i th coordinate of \mathbf{v} in this basis is $\mathbf{u}_i^t \mathbf{v}$. Since \mathbf{u}_i^t is the i th row of B^t , the vector of coordinates is just $B^t \mathbf{v}$.
- (b) Since the norm of both \mathbf{u}_i and \mathbf{w} are one, $\cos(\theta_i) = \mathbf{u}_i \cdot \mathbf{w}$, where θ_i is the angle that \mathbf{u}_i makes with \mathbf{w} .
- (c) (i)

```
>> deg = 180/pi;
>> w = [1; 1]/norm([1;1])
>> v1 = [1; 0]; v2 = [0; 1];
>> acos( w'*v1)*deg           % The angle between w and v1 in degrees.
ans =
    45.0000

>> acos( w'*v2)*deg           % The angle between w and v2 in degrees.
ans =
    45.0000
```

(ii)

```
>> w = [-1; 0];
>> v1 = [1; 1]/norm([1;1]);
>> v2 = [-1; 1]/norm([-1;1]);
>> acos( w'*v1)*deg           % The angle between w and v1 in degrees.
ans =
    135

>> acos( w'*v2)*deg           % The angle between w and v2 in degrees.
ans =
    45.0000
```

(d)

```
>> B = [2 2 -1; 2 -1 2; -1 2 2]/3 ;
>> B' * B                       % This should be the identity.
ans =
     1     0     0
     0     1     0
     0     0     1

>> s = [1; 1; 1];
>> w = s/norm(s);
>> c = w' * B;                   % The cosines of the angles.
>> acos(c) * deg                 % Entries agree with acos((s'*B(:,i))/norm(s))
ans =
    54.7356    54.7356    54.7356
```

10. (a)

```
>> B = 1/sqrt(2) * [1 1; 1 -1];
>> B' * B % This should be the identity.
ans =
    1.0000    0
         0    1.0000
```

(b)

```
>> B1 = 1/14 * [-4 -6 12; 6 -12 -4; 12 4 6];
>> B1' * B1 % This should be the identity.
ans =
    1.0000    0.0000    0
    0.0000    1.0000    0.0000
         0    0.0000    1.0000
```

(c)

```
>> B2 = 1/39 * [-13 14 -34; -26 -29 -2; -26 22 19];
>> B2' * B2 % This should be the identity.
ans =
     1     0     0
     0     1     0
     0     0     1
```

(d)

```
>> B3 = orth(rand(3));
>> B3' * B3 % This should be the identity.
ans =
    1.0000    0.0000    0.0000
    0.0000    1.0000    0
    0.0000         0    1.0000
```

(e)

```
>> v1 = [-1; 2; 3]; v2 = [0; 1; 1]; v3 = [-1; 2; 4];
>> u1 = v1/norm(v1);
>> u2 = v2 - (u1'*v2)*u1; u2 = u2 / norm(u2);
>> u3 = v3 - (u1'*v3)*u1 - (u2'*v3)*u2; u3 = u3 / norm(u3);
>> B4 = [u1 u2 u3]
B4 =
   -0.2673    0.7715    0.5774
    0.5345    0.6172   -0.5774
    0.8018   -0.1543    0.5774

>> B4' * B4 % This should be the identity.
ans =
    1.0000    0.0000    0.0000
    0.0000    1.0000    0.0000
    0.0000    0.0000    1.0000
```

11. (a)

```

>> B = B1*B2
B =
   -0.1905    0.6996    0.6886
    0.6190    0.6300   -0.4689
   -0.7619    0.3370   -0.5531

>> B' * B                                % This should be the identity.
ans =
    1.0000    0.0000         0
    0.0000    1.0000    0.0000
         0    0.0000    1.0000

>> B = B1*B3
B =
   -0.2959    0.3625    0.8837
   -0.4714   -0.8601    0.1950
    0.8308   -0.3589    0.4254

>> B' * B                                % This should be the identity.
ans =
    1.0000    0.0000    0.0000
    0.0000    1.0000    0.0000
    0.0000    0.0000    1.0000

>> B = B2*B4
B =
   -0.4180    0.0989   -0.9030
   -0.2604   -0.9654    0.0148
    0.8703   -0.2413   -0.4293

>> B' * B                                % This should be the identity.
ans =
    1.0000    0.0000    0.0000
    0.0000    1.0000    0.0000
    0.0000    0.0000    1.0000

>> B = B3*B4
B =
   -0.4188   -0.0527    0.9065
   -0.2893    0.9540   -0.0782
    0.8607    0.2950    0.4148

>> B' * B                                % This should be the identity.
ans =
    1.0000    0.0000    0.0000
    0.0000    1.0000    0.0000
    0.0000    0.0000    1.0000

```

(b) See the solution to Problem 16 above.

12. (a)

```

>> B = 1/sqrt(2) * [1 1; 1 -1]; % B from MATLAB Problem 10 changed by Problem 11.
>> A = inv(B)
A =
    0.7071    0.7071
    0.7071   -0.7071

>> A' * A % This should be the identity.
ans =
    1.0000    0
         0    1.0000

>> A = inv(B1) % Matrices B1, B2, B3, B4 previously entered
A = % in MATLAB Problem 10, and not changed.
   -0.2857    0.4286    0.8571
   -0.4286   -0.8571    0.2857
    0.8571   -0.2857    0.4286

>> A' * A % This should be the identity.
ans =
    1.0000    0.0000    0.0000
    0.0000    1.0000    0.0000
    0.0000    0.0000    1.0000

>> A = inv(B2)
A =
   -0.3333   -0.6667   -0.6667
    0.3590   -0.7436    0.5641
   -0.8718   -0.0513    0.4872

>> A' * A % This should be the identity.
ans =
    1.0000    0.0000    0
    0.0000    1.0000    0.0000
         0    0.0000    1.0000

>> A = inv(B3);
>> A' * A % This should be the identity.
ans =
    1.0000    0.0000    0.0000
    0.0000    1.0000    0.0000
    0.0000    0.0000    1.0000

>> A = inv(B4)
A =
   -0.2673    0.5345    0.8018
    0.7715    0.6172   -0.1543
    0.5774   -0.5774    0.5774

>> A' * A % This should be the identity.
ans =
    1.0000    0.0000    0.0000
    0.0000    1.0000    0.0000
    0.0000    0.0000    1.0000

```

- (b) The matrix B is orthogonal if $B^t B = I$. Since this is the definition of the inverse of B , we see that $A = B^t$ is in fact B^{-1} . Since $A^t = B$, we then have $A^t A = B B^{-1} = I$, i.e. B^{-1} is orthogonal.

13. (a)

```

>> det(B)
ans =
    -1.0000
>> det(B1)
ans =
     1
>> det(B2)
ans =
    1.0000
>> det(B3)
ans =
     1
>> det(B4)
ans =
    -1.0000

```

- (b) Take the determinant of $B^t B = I$, and use $\det(B^t) = \det(B)$. We get $\det(B)^2 = \det(I) = 1$, so $\det(B) = \pm 1$.
- (c) Since the volume of the parallelepiped formed by $Q\mathbf{u}$, $Q\mathbf{v}$ and $Q\mathbf{w}$ is that of the parallelepiped formed by \mathbf{u} , \mathbf{v} and \mathbf{w} multiplied by $|\det(Q)|$, and since $\det(Q) = \pm 1$, they will have the same volumes.

14. (a)

```

>> Q = B1; deg = 180/pi;
>> v = 2*rand(3,1)-1;
>> w = 2*rand(3,1)-1;
>> norm(v), norm(Q*v)           % compare the lengths.
ans =
    0.4455
ans =
    0.4455
>> acos(v'*w/(norm(v)*norm(w))) * deg % The angle between v and w (in degrees)
ans =
    75.1669
>> qv = Q*v; qw = Q*w;
>> acos(qv'*qw/(norm(qv)*norm(qw))) * deg % The angle between Qv and Qw
ans =
    75.1669

```

For any \mathbf{v} and \mathbf{w} , multiplication by Q will preserve both lengths and angles.

(b)

```

>> Q = orth(2*rand(6)-1);
>> Q'*Q           % This should be the identity.
ans =
    1.0000    0.0000    0.0000    0.0000    0.0000    0.0000
    0.0000    1.0000    0.0000    0.0000    0.0000    0.0000
    0.0000    0.0000    1.0000    0.0000    0.0000    0.0000
    0.0000    0.0000    0.0000    1.0000    0.0000    0.0000
    0.0000     0.0000    0.0000    0.0000    1.0000    0.0000
    0.0000    0.0000    0.0000    0.0000    0.0000    1.0000

```



```
>> v = 2*rand(6,1)-1;
>> w = 2*rand(6,1)-1;
>> norm(v), norm(Q*v)           % compare the lengths.
ans =
    1.4703
ans =
    1.4703
>> acos(v'*w/(norm(v)*norm(w))) * deg % The angle between v and w (in degrees)
ans =
    103.8352
>> qv = Q*v; qw = Q*w;
>> acos(qv'*qw/(norm(qv)*norm(qw))) * deg % The angle between Qv and Qw
ans =
    103.8352
```

Orthogonal matrices preserve angles and lengths.

(c)

```
>> Q = orth(2*rand(6)-1);
>> x = 2*rand(6,1)-1; z = 2*rand(6,1)-1;
>> xx = inv(Q)*x; zz = inv(Q)*z; % Q is the transition matrix from Q to S,
                                   % so inv(Q) is the transition from S to Q.
>> norm(x-z), norm(xx-zz)         % Compare.
ans =
    2.5292
ans =
    2.5292
```

The distance between two vectors can be computed using coordinates with respect to any orthonormal basis.

- (d) Since multiplication by Q or by Q^{-1} does not change lengths, we expect that changing from one orthogonal basis to another will not increase any errors in the original representation. For example, if \mathbf{x} is the true vector, and \mathbf{z} is the computed vector, then the error would be $|\mathbf{x} - \mathbf{z}|$. In the new basis, this would be $|\mathbf{xx} - \mathbf{zz}|$ which has the same size as $|\mathbf{x} - \mathbf{z}|$.
- (e) From the identity $Q^t Q = I$, we get

$$Q\mathbf{v} \cdot Q\mathbf{w} = (Q\mathbf{v})^t Q\mathbf{w} = \mathbf{v}^t (Q^t Q)\mathbf{w} = \mathbf{v}^t \mathbf{w} = \mathbf{v} \cdot \mathbf{w}.$$

$|Q\mathbf{v}| = \sqrt{Q\mathbf{v} \cdot Q\mathbf{v}} = \sqrt{\mathbf{v} \cdot \mathbf{v}} = |\mathbf{v}|$, and so $\text{acos}(Q\mathbf{v} \cdot Q\mathbf{w}/|Q\mathbf{v}||Q\mathbf{w}|) = \text{acos}(\mathbf{v} \cdot \mathbf{w}/(|\mathbf{v}||\mathbf{w}|))$.

- (f) $|Q\mathbf{x} - Q\mathbf{z}| = |Q(\mathbf{x} - \mathbf{z})| = |\mathbf{x} - \mathbf{z}|$, as Q preserves lengths. Hence Q preserves distances between points.

15. (a) Choose an angle, say $\pi/4$ and form V as in MATLAB 4.8.9(b)

```
>> V'*V           % This is I, so the rotation V is orthogonal, for any angle.
ans =
     1     0
     0     1
```

For the same angle form P , R , and Y as in MATLAB 4.8.10(a).

```
>> P'*P           % These will be I for any angle so P,R,Y orthogonal:
ans =
    1.0000         0         0
         0    1.0000         0
         0         0    1.0000
```

```

>> R'*R
ans =
     1     0     0
     0     1     0
     0     0     1

>> Y'*Y
ans =
     1     0     0
     0     1     0
     0     0     1

```

- (b) The standard basis is orthonormal, rotation preserves lengths and angles, and the columns of a rotation matrix are just the rotations of the standard basis. Hence these n columns form an orthonormal set which must be a basis since the set has n independent vectors in the n dimensional space \mathbb{R}^n .
- (c) The product of orthogonal matrices is also orthogonal, so the attitude matrix will be orthogonal.
- (d) Since A is the transition matrix from the satellite's basis to the standard coordinates, A^{-1} will be the transition matrix back.

```

>> v1 = [.7017; -.7017; 0]; v2 = [.2130; .2130; .9093];
>> v3 = [ .1025; -.4125; .0726];
>> A = inv( [v1 v2 v3])           % Solve V = inv(A) * I for A.
A =
     1.7793     0.3542    -0.4998
     0.2321     0.2321     0.9910
    -2.9069    -2.9069     1.3618

>> A'*A                           % This should be I.
ans =
    11.6696     9.1339    -4.6179
     9.1339     8.6292    -3.9057
    -4.6179    -3.9057     3.0865

```

Since $A^t A$ was not the identity, A is not orthogonal. This indicates an error. We could have checked $[v1\ v2\ v3]' * [v1\ v2\ v3] \neq I$ directly without finding A .

(e)

```

>> ph = pi/4;
>> P = [ cos(ph) 0 sin(ph); 0 1 0; -sin(ph) 0 cos(ph)]; % Pitch.
>> al = -pi/3;
>> R = [ 1 0 0; 0 cos(al) -sin(al); 0 sin(al) cos(al)]; % Roll.
>> th = pi/6;
>> Y = [ cos(th) -sin(th) 0; sin(th) cos(th) 0; 0 0 1]; % The yaw matrix.
>> A = Y*R*P*eye(3)
A =
     0.9186    -0.2500     0.3062
    -0.1768     0.4330     0.8839
    -0.3536    -0.8660     0.3536

```

The ij th element of $A^t I$ will be the dot product of the i th column of A with the j th column of I . Since the columns have unit length, we can take the arccosine to compute the angles between them.

```

>> acos( A' * eye(3) ) * deg % the angles, in degrees. col 1 for (1, 0, 0)',
                               % col. 2 for (0, 1, 0), ...
ans =
    23.2837   100.1821   110.7048
   104.4775    64.3411   150.0000
    72.1705    27.8856    69.2952

```

16. (a)

```

>> x = 2*rand(3,1)-1; v = x/ norm(x);
>> H = eye(3) - 2*v * v'
H =
   -0.0169   -0.9999   -0.0023
   -0.9999    0.0169   -0.0023
   -0.0023   -0.0023    1.0000

>> H' * H                                % This should be the identity.
ans =
    1.0000    0.0000    0.0000
    0.0000    1.0000     0
    0.0000     0    1.0000

```

(b)

```

>> n = 7; x = 2*rand(n,1)-1; v = x/ norm(x); % Part (b).
>> H = eye(n) - 2*v * v';
>> norm( eye(n) - H'*H )                % This should be zero: H'*H should be I.
ans =
    3.4777e-16

```

(c) Compute $H^t H$:

$$H^t H = (I^t - (2vv^t)^t)(I - 2vv^t) = (II - 2vv^t - 2vv^t + (-2vv^t)(-2vv^t)) = I - 4vv^t + 4vv^t vv^t.$$

Since $v^t v = 1$, the last term, $4vv^t vv^t$ is the same as $4vv^t$, the second term. Hence $H^t H = I$.

(d) This is a sample of the resulting plot, using

```
>>vv = [1;1]; x = [-1;2];
```

and plotting the reflected vector using line type '-.'

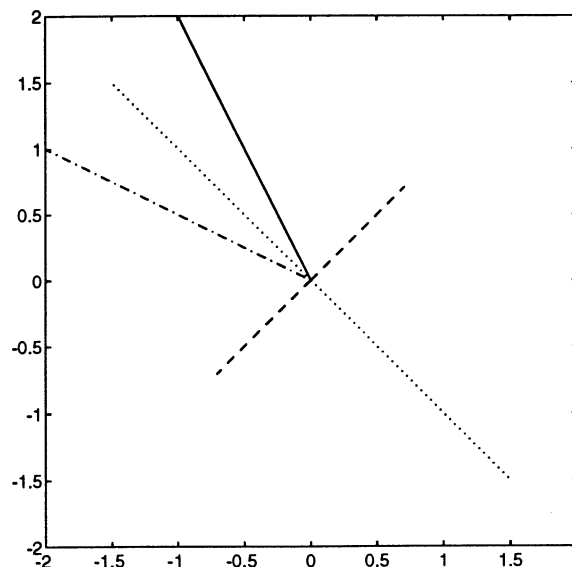

(e) Since H represents the reflection across a line, $H = H^{-1}$. This can be proved by noticing that $H = H^t$, and since H is orthogonal, $H^t = H^{-1}$.

Section 4.10

An efficient alternate route to the solutions in Problems 4–8 is to compute $A^t\mathbf{y}$, and solve $A^t\mathbf{A}\mathbf{u} = A^t\mathbf{y}$ by elimination, skipping $(A^tA)^{-1}$.

$$1. A = \begin{pmatrix} 1 & 1 \\ 1 & -2 \\ 1 & 7 \end{pmatrix}, \mathbf{y} = \begin{pmatrix} 3 \\ 4 \\ 0 \end{pmatrix}, A^tA = \begin{pmatrix} 3 & 6 \\ 3 & 54 \end{pmatrix}, (A^tA)^{-1} = \frac{1}{126} \begin{pmatrix} 54 & -6 \\ -6 & 3 \end{pmatrix}. \text{ Then } \mathbf{u} = \begin{pmatrix} 68/21 \\ -19/42 \end{pmatrix};$$

$$y = (136 - 19x)/42$$

$$2. A = \begin{pmatrix} 1 & -3 \\ 1 & 4 \end{pmatrix}, \mathbf{y} = \begin{pmatrix} 7 \\ 9 \end{pmatrix}, A^tA = \begin{pmatrix} 2 & 1 \\ 1 & 25 \end{pmatrix}, (A^tA)^{-1} = \frac{1}{49} \begin{pmatrix} 25 & -1 \\ -1 & 2 \end{pmatrix}. \text{ Then } \mathbf{u} = \begin{pmatrix} 55/7 \\ 2/7 \end{pmatrix}; y = (55 - 2x)/7$$

$$3. A = \begin{pmatrix} 1 & 1 \\ 1 & 4 \\ 1 & -2 \\ 1 & 3 \end{pmatrix}, \mathbf{y} = \begin{pmatrix} -3 \\ 6 \\ 5 \\ -1 \end{pmatrix}, A^tA = \begin{pmatrix} 4 & 6 \\ 6 & 30 \end{pmatrix}, (A^tA)^{-1} = \frac{1}{84} \begin{pmatrix} 30 & -6 \\ -6 & 4 \end{pmatrix}. \text{ Then } \mathbf{u} = \begin{pmatrix} 27/14 \\ -5/42 \end{pmatrix};$$

$$y = (81 - 5x)/42$$

$$4. A = \begin{pmatrix} 1 & 2 & 4 \\ 1 & 3 & 9 \\ 1 & 1 & 1 \\ 1 & 4 & 16 \end{pmatrix}, \mathbf{y} = \begin{pmatrix} -5 \\ 0 \\ 1 \\ -2 \end{pmatrix}, A^tA = \begin{pmatrix} 4 & 10 & 30 \\ 10 & 30 & 100 \\ 30 & 100 & 354 \end{pmatrix}, (A^tA)^{-1} = \frac{1}{40} \begin{pmatrix} 310 & -270 & 50 \\ -270 & 258 & -50 \\ 50 & -50 & 10 \end{pmatrix}. \text{ Then}$$

$$\mathbf{u} = \begin{pmatrix} 9/2 \\ -27/5 \\ 1 \end{pmatrix}; y = (45 - 54x + 10x^2)/10$$

$$5. A = \begin{pmatrix} 1 & -7 & 49 \\ 1 & 2 & 4 \\ 1 & 1 & 1 \end{pmatrix}, \mathbf{y} = \begin{pmatrix} 3 \\ 8 \\ 5 \end{pmatrix}, A^tA = \begin{pmatrix} 3 & -4 & 54 \\ -4 & 54 & -334 \\ 54 & -334 & 2418 \end{pmatrix}, (A^tA)^{-1} =$$

$$\frac{1}{2592} \begin{pmatrix} 9508 & -4182 & -790 \\ -4182 & 2169 & 393 \\ -790 & 393 & 73 \end{pmatrix}. \text{ Then } \mathbf{u} = \begin{pmatrix} 47/18 \\ 25/12 \\ 11/36 \end{pmatrix}, y = (94 + 75x + 11x^2)/36$$

$$6. A = \begin{pmatrix} 1 & 1 & 1 \\ 1 & 3 & 9 \\ 1 & 5 & 25 \\ 1 & -3 & 9 \\ 1 & 7 & 49 \end{pmatrix}, \mathbf{y} = \begin{pmatrix} -1 \\ -6 \\ 2 \\ 1 \\ 4 \end{pmatrix}, A^tA = \begin{pmatrix} 5 & 13 & 93 \\ 13 & 93 & 469 \\ 93 & 469 & 3189 \end{pmatrix}, (A^tA)^{-1} =$$

$$\frac{1}{21728} \begin{pmatrix} 9577 & 270 & -319 \\ 270 & 912 & -142 \\ -319 & -142 & 37 \end{pmatrix}. \text{ Then } \mathbf{u} = \begin{pmatrix} -7435/2716 \\ -863/1358 \\ 641/2716 \end{pmatrix}, y = (-7435 - 1726x + 641x^2)/2716$$

7. As with the linear approximation on page 420–421, $\mathbf{A}\mathbf{u} = \text{proj}_H \mathbf{y}$. Then, $\mathbf{A}\mathbf{u} \perp (\mathbf{y} - \mathbf{A}\mathbf{u}) \Rightarrow \mathbf{u} = (A^tA)^{-1}A^t\mathbf{y}$.

$$8. A = \begin{pmatrix} 1 & 3 & 9 & 27 \\ 1 & 0 & 0 & 0 \\ 1 & -1 & 1 & -1 \\ 1 & 2 & 4 & 8 \\ 1 & 1 & 1 & 1 \end{pmatrix}, \mathbf{y} = \begin{pmatrix} -2 \\ 3 \\ 4 \\ -2 \\ 2 \end{pmatrix}, A^tA = \begin{pmatrix} 5 & 5 & 15 & 35 \\ 5 & 15 & 35 & 99 \\ 15 & 35 & 99 & 275 \\ 35 & 99 & 275 & 795 \end{pmatrix},$$

$$(A^tA)^{-1} = \frac{1}{2520} \begin{pmatrix} 1944 & -60 & -1440 & 420 \\ -60 & 1000 & -150 & -70 \\ -1440 & -150 & 1755 & -525 \\ 420 & -70 & -525 & 175 \end{pmatrix}. \text{ Then } \mathbf{u} = \frac{1}{252} \begin{pmatrix} 900 \\ -426 \\ -27 \\ 84 \end{pmatrix}, y = (900 - 426x - 27x^2 +$$

$84x^3)/252$.

9. This is a generalization of problem 7. The same reasoning applies.

10. (a) Let $y = a + bx + cx^2$. Then $\begin{pmatrix} 1 & 1 & 1 \\ 1 & -1 & 1 \\ 1 & 3 & 9 \end{pmatrix} \begin{pmatrix} a \\ b \\ c \end{pmatrix} = \begin{pmatrix} 5.52 \\ 15.52 \\ 11.28 \end{pmatrix}$. Then $a = 8.55$, $b = -5$ and $c = 1.97$.

Note that $8.55 - 5(-2) + 1.97(-2)^2 = 26.43$. So all four points lie on the same parabola $y = 8.55 - 5x + 1.97x^2$.

(b) $A = \begin{pmatrix} 1 & 1 & 1 \\ 1 & -1 & 1 \\ 1 & 3 & 9 \\ 1 & -2 & 4 \end{pmatrix}$, $\mathbf{u} = \begin{pmatrix} 8.55 \\ -5 \\ 1.97 \end{pmatrix}$, $\mathbf{y} = \begin{pmatrix} 5.52 \\ 15.52 \\ 11.28 \\ 26.43 \end{pmatrix}$. Then $A\mathbf{u} = \mathbf{y} \Rightarrow \mathbf{y} - A\mathbf{u} = \mathbf{0} \Rightarrow |\mathbf{y} - A\mathbf{u}| = 0$.

11. $A = \begin{pmatrix} 1 & 10 & 100 \\ 1 & 30 & 900 \\ 1 & 50 & 2500 \\ 1 & 100 & 10000 \\ 1 & 175 & 30625 \end{pmatrix}$, $\mathbf{y} = \begin{pmatrix} 150 \\ 260 \\ 325 \\ 500 \\ 670 \end{pmatrix}$, $A^t A = \begin{pmatrix} 5 & 365 & 44125 \\ 365 & 44125 & 6512375 \\ 44125 & 6512375 & 1044960625 \end{pmatrix}$. Then $\mathbf{u} = \begin{pmatrix} 108.715 \\ 4.906 \\ -0.01 \end{pmatrix}$,

$c = 108.715 + 4.906x - 0.01x^2$, using c for cost.

12. $A = \begin{pmatrix} 1 & 1 & 1 \\ 1 & 1.5 & 2.25 \\ 1 & 2.5 & 6.25 \\ 1 & 4 & 16 \end{pmatrix}$, $\mathbf{y} = \begin{pmatrix} 57 \\ 67 \\ 68 \\ 9.5 \end{pmatrix}$. Then $\mathbf{u} = \begin{pmatrix} 10.898 \\ 60.947 \\ -15.318 \end{pmatrix}$.

(a) $s_0 = 10.898$ ft.

(b) $v_0 = 60.947$ ft./sec.

(c) $g/2 = -15.318 \Rightarrow g = -30.636$ ft./sec.²

CALCULATOR SOLUTIONS 4.10

Problems 13-16 ask you to find the linear regression line for some x-y data pairs and then problems 17-20 request the quadratic regression curve for the same data; each type is to be calculated to eight significant digits. To have the results listed to the requested accuracy we place the calculator in scientific mode with 8 digits to the right of the decimal place by using the **MODE** menu or by keying in `SCI:FIX 8` `[ENTER]`. Next we carry out the desired regression calculation using the functions **LINR** and **P2REG** from the **STAT** menu, both of which have x-list and y-list arguments.

Two different approaches to entering the data and carrying out the calculations can be followed.

Either we can do the (x,y) pair data entry together from the **STAT** menu and then perform the regression calculations as suggested in the text:

1. We enter the **STAT** menu and prepare to enter the lists via:

`[STAT]` `[F2]` `<EDIT>`

2. We name the lists (with the problem number since we'll have to reuse each one) via:

`X41013` `[ENTER]` `Y41013` `[ENTER]`

3. We then enter the (x,y) points in order by

`57` `[ENTER]` `84` `[ENTER]` `43` `[ENTER]` `91` `[ENTER]` `71` `[ENTER]` `36` `[ENTER]` `83` `[ENTER]`
`24` `[ENTER]` `108` `[ENTER]` `15` `[ENTER]` `141` `[ENTER]` `8` `[ENTER]`. (We can type `[EXIT]` at this point to indicate we are done entering data, although this is not necessary.)

4. Then we calculate the linear regression equation:

- (a) We go to the **STAT CALC** menu by `[2nd]` `[CALC]` (if we stopped the previous step without an `[EXIT]`) or by `[STAT]` `[F1]` `<CALC>` (if we used `[EXIT]`).
- (b) `[ENTER]` `[ENTER]` (to accept the x-list and y-list entered previously; or insert a different x-list and/or y-list name before each `[ENTER]`).
- (c) `[F2]` `<LINR>` to calculate and display the regression coefficients for the line $y = a + bx$, or `[MORE]` `[F1]` `<P2REG>` to calculate and display the regression coefficients $\{c_2, c_1, c_0\}$ for the 2nd degree polynomial $y = c_2x^2 + c_1x + c_0$ (yes the coefficients for the polynomial come out in this (reversed) order).

Or we can enter the x-data into a list and the y-data (say for Problem 13) into a list from the `[2nd]` `[LIST]` menu by `{57,43,71,83,108,141}` `[STO>]` `X41013` `[ENTER]` and `{84,91,36,24,15,8}` `[STO>]` `Y41013` `[ENTER]`. Then compute the linear regression equation by literally keying in `LINR(X41013,Y41013)` `[ENTER]`. To see the coefficients of the linear regression line $y = a + bx$ we must enter `SHWST` `[ENTER]`, which displays the last computed **STAT CALC** result. For the 2'nd degree polynomial regression equation from this data (i.e. for Problem 17) instead of `LINR` we key in `P2REG(X41013,Y41013):PRegC` `[ENTER]` which calculates and displays the coefficients for the quadratic regression curve.

Although you are not asked to get the graphs of the regression curves, it is very easy to do and very helpful in assessing the reasonableness of the least squares fitting that has been done. After you perform the regression step above, you can look at the graphs by doing the following steps:

- G1. Go to the **GRAPH RANGE** menu by entering `[GRAPH]` `[F2]` `<RANGE>` and establish a reasonable graphing range which encloses the min and max of the x-list and the y-list. For Problem 13 and 17 this might be done by entering values `xMin=0` `[v]` `xMax=150` `[v]` `yMin=0` `[v]` `yMax=100`. The values you enter here should be nice values slightly outside the x-list and y-list limits. (If you want to have axes with tick marks you will have to set `LabelOn` on the **GRAPH FORMAT** menu, and you should set `xSc1=10` (or 25) and `ySc1=10(or25)` during the **RANGE** setting operation. The choices for scales should be chosen to mesh

nicely with the range values you choose and not generate too many tick marks.)

G2. Now that the range and format are set, you can graph the data with **STAT** **F3** **<DRAW>** **F2** **<SCAT>**. (Or from the Home screen you could enter SCAT (X41013, Y41013).)

G3. To draw the regression curve you enter **F4** **<DRREG>** from the **STAT DRAW** menu. (Note that this will draw the regression line if the last **CALC** was **LINR** and will draw the quadratic regression curve if the last **CALC** was **P2REG**.)

13. Once the data is in lists, **LINR (X41013, Y41013) : SHWST** **ENTER** shows the regression line is $y = a + bx$ with $a = 116.717661$ and $b = -.87933592$. The scatter plot and regression line for this data look like:

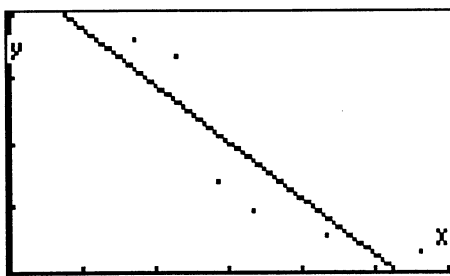

14. Once the data is in lists, **LINR (X41014, Y41014) : SHWST** **ENTER** shows the regression line is $y = a + bx$ with $a = 35.935675546$ and $b = -83.4295656347$. The scatter plot and regression line for this data look like:

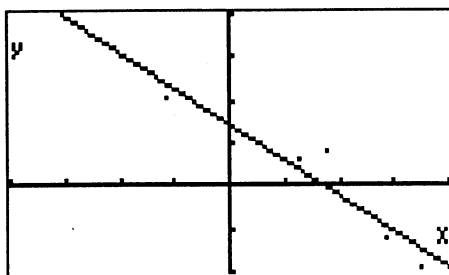

15. Once the data is in lists, **LINR (X41015, Y41015) : SHWST** **ENTER** shows the regression line is $y = a + bx$ with $a = -1.11930576E+2$ and $b = 2.13326527$. The scatter plot and regression line for this data look like:

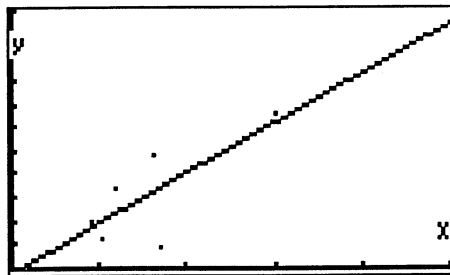

16. Once the data is in lists, `LINR (X41016, Y41016) : SHWST` `ENTER` shows the regression line is $y = a + bx$ with $a = -.194215756$ and $b = 1.19206507$. The scatter plot and regression line for this data look like:

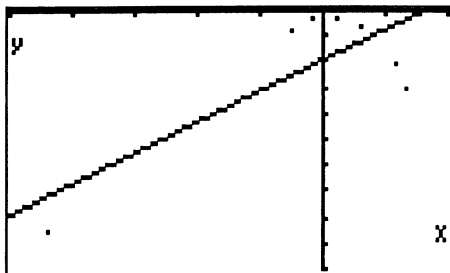

17. Once the Problem 13 data is in lists, `P2REG (X41013, Y41013) : PRegC` `ENTER` shows the quadratic regression equation is $y = c_2x^2 + c_1x + c_0$ with

$$\{c_2, c_1, c_0\} = \{1.35739160E-2, -3.39135882, 2.17421277E2\}.$$

The scatter plot and regression curve for this data look like:

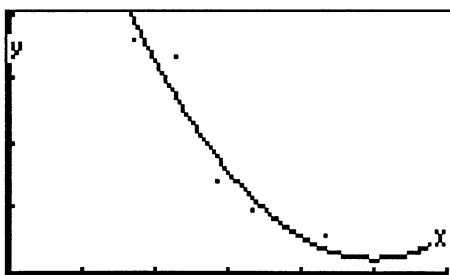

18. Once the Problem 14 data is in lists, `P2REG (X41014, Y41014) : PRegC` `ENTER` shows the quadratic regression equation is $y = c_2x^2 + c_1x + c_0$ with

$$\{c_2, c_1, c_0\} = \{-5.95481073E1, -5.12577254E1, 4.15798115E1\}.$$

The scatter plot and regression curve for this data look like:

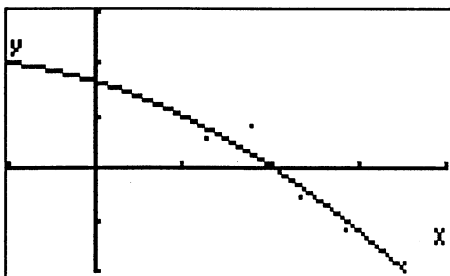

19. Once the Problem 15 data is in lists, `P2REG (X41015, Y41015) : PRegC` `ENTER` shows the quadratic regression equation is $y = c_2x^2 + c_1x + c_0$ with

$$\{c_2, c_1, c_0\} = \\ \{4.05643705E-5, 2.01798202762, -5.38851804E1\}.$$

The scatter plot and regression curve for this data look like:

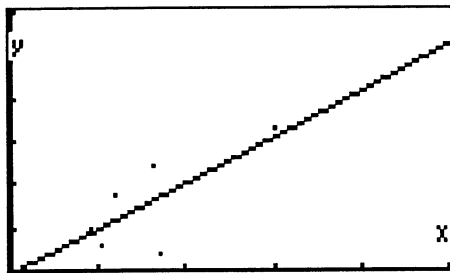

20. Once the Problem 20 data is in lists, P2REG (X41020, Y41020) :PRegC shows the quadratic regression equation is $y = c_2x^2 + c_1x + c_0$ with

$$\{c_2, c_1, c_0\} = \{-5.77514119, -.70783606, -4.23378036E-2\}.$$

The scatter plot and regression curve for this data look like:

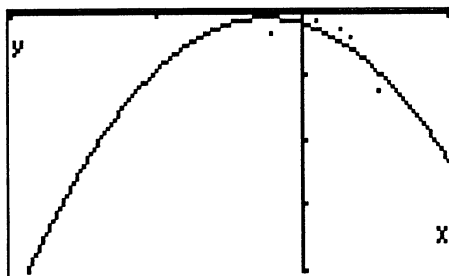

MATLAB 4.10

1. (a)

```
>> x = [1 2 -1 3.5 2.2 4]';
>> y = [2 .5 4 -1 .4 -2]';
>> A = [ones(6,1) x];           % See formulas 3, 4 in the text.
```

(b)

```
>> u = inv(A'*A) * A' * y
u =
    2.9535
   -1.1813

>> v = A\y
v =
    2.9535
   -1.1813
```

(c) (Problem should say “and compare with $|y - Au|$ ”)

```
>> norm( y - A*u)
ans =
    0.4066

>> w = u + [.1; -.5];
>> norm(y - A*w)
ans =
    2.9712
```

The sum of squares of coordinate differences in y -coordinates between the data points and the least squares line is smaller than for any other line.

(d)

```
>> B = orth(A)
B =
    0.1599   -0.4433
    0.3199   -0.2540
   -0.1599   -0.8221
    0.5598    0.0301
    0.3519   -0.2161
    0.6398    0.1248

>> h = B*B'*y           % This is the projection of y onto H.
h =
    1.7722
    0.5909
    4.1347
   -1.1810
    0.3547
   -1.7716
```

```

>> A*u                                % Compare with h.
ans =
    1.7722
    0.5909
    4.1347
   -1.1810
    0.3547
   -1.7716

```

(e) Here is the plot generated by the code in the text:

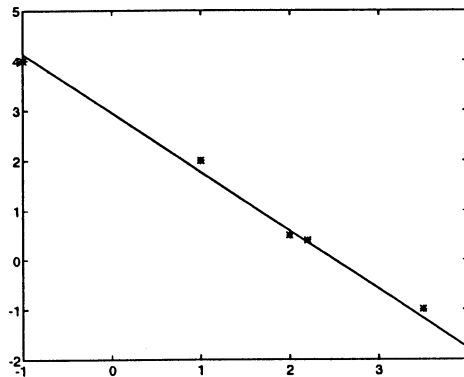

The line seems to be a good fit to the data.

(f)

```

>> [1 2.9] * u
ans =
   -0.4722

```

2. (a)

```

>> x = [10 30 50 100 175]' ;
>> y = [150 260 325 500 670]' ;
>> A = [ones(5,1) x x.^2]      % See formulas (11)-(12) in the text.
A =                             % recall x.^2 squares the elements in x.
     1         10         100
     1         30         900
     1         50        2500
     1        100       10000
     1        175       30625

```

(b)

```

>> u = inv(A'*A) * A'* y
u =
    108.7146
     4.9064
    -0.0097

```

```

>> v = A\y                                % Compare with u.
v =
  108.7146
   4.9064
  -0.0097
>> norm( y - A*u)
ans =
  15.4359
>> w = u + [.1; -.2; -.05];
>> norm(y - A*w)
ans =
  1.6566e+03

```

As in problem 1, $|y - Au|$ is the minimum.

```

>> B = orth(A)
B =
  0.0031    0.1576    0.8226
  0.0278    0.4100    0.3711
  0.0773    0.5786    0.0206
  0.3093    0.6334   -0.4134
  0.9474   -0.2666    0.1197
>> h = B*B'*y                                % This is the projection of y onto H.
h =
  156.8051
  247.1472
  329.7042
  502.0374
  669.3062
>> A*u                                        % Compare with h.
ans =
  156.8051
  247.1472
  329.7042
  502.0374
  669.3062

```

Here is a graph of the data:

```

>> u = A\y;
>> s = min(x):( max(x)-min(x))/100:max(x);
>> fit = u(1) + u(2)*s + u(3)*(s.^2);
>> plot(x,y,'w*', s,fit)

```

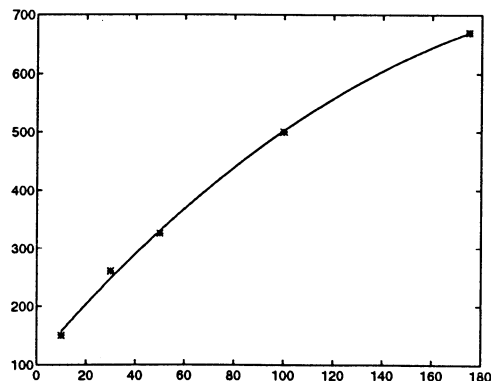

(c)

```

>> [1 75 75^2] * u           % For x = 75.
ans =
    421.9528

>> [1 200 200^2] * u       % For x = 200
ans =
    700.7343

```

3. Problem 12.

```

>> x = [1 1.5 2.5 4]' ;      % the data.
>> y = [57 67 68 9.5]' ;
>> A = [ones(4,1) x x.^2]    % See formulas (11)-(12) in the text.
A =
    1.0000    1.0000    1.0000
    1.0000    1.5000    2.2500
    1.0000    2.5000    6.2500
    1.0000    4.0000   16.0000

>> u = A \ y                 % See problem 1.
u =
    10.8977
    60.9470
   -15.3182

>> g = u(3)*2                % needed for part (c).
g =
   -30.6364

```

Even the estimates $s(t) = u(1) + u(2)t + u(3)t^2 = s_0 + v_0t + \frac{1}{2}gt^2$ we get (a) the height is $s_0 = 10.9$, (b) the initial velocity is $v_0 = 60.9$, and (c) gravity is $g = -30.6$.

4. (a)

```

>> r = 1.5; t = -3.8
>> xx = [x; r]; yy = [y; t];
>> A = [ones(7,1) xx]; uu = A \ yy;

```

(i); (ii) Use the modified command `plot(x, y, 'w*', r, t, 'wo', s, fit, '-r', s, fit1, ':b')` to get solid and dotted lines for visibility in black and white print outs.

Here is a graph of the two different lines. The solid line is from problem 1, the dotted line is found using the additional data point, located near the middle bottom of the plot. Note the new point lies far away from the approximately linear plot of the original data. Thus it is an “outlier”.

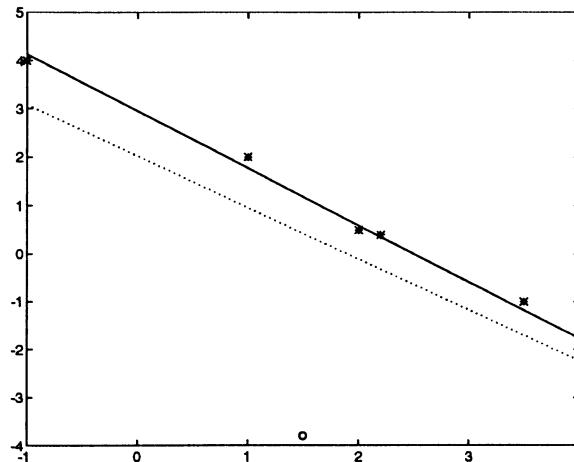

(iii) The outlier moves the entire least squares line toward it and slightly away from fitting the other data. Since the original line so closely matches all but one point it seems like a better fit.

(b) A different modification of Problem 1:

```
>> r=4.9;t=4.5;
>> xx = [x; r]; yy = [y; t];
>> A = [ones(7,1) xx]; uu = A\yy
uu =
    2.1482
   -0.3998
>> ss = min(xx):(max(xx)-min(xx))/100:max(xx);
>> fit2 = uu(1)+uu(2)*ss;
>> plot(x,y,'w*',r,t,'wo',s,fit,'-r',ss,fit2,':b');
>> print -deps fig4104b.eps
```

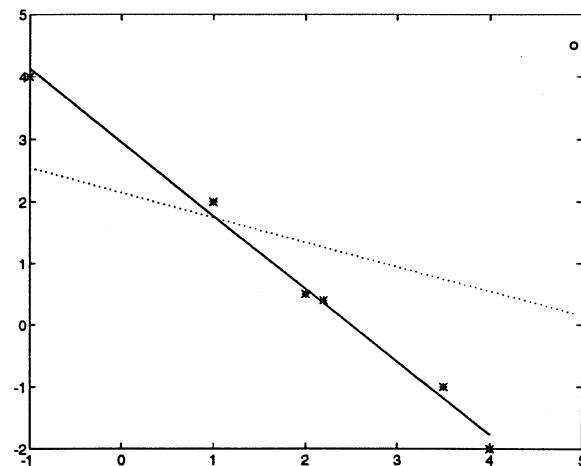

Again the new point, identified via a “o” on the plot, has a y value far away from the generally expected position based on the original data and the original (solid) least squares approximation. This “outlier” causes the least squares approximation to rotate significantly (to the dotted line) and fail to fit the general trend of most of the data.

5. (a)

```

>> x = [-0.0162 -0.0515 0.0216 0.0628 0.0855 0.1163 0.1316 -0.4416]';
>> y = [ -0.0315 -0.0813 -0.0339 -0.0616 -0.0919 -0.2105 -0.3002 -0.8519]';
>> l = length(x); A = [ ones(l,1) x]; % For the least squares line.
>> u = A\y
u =
   -0.1942
    1.1921

>> B = [ ones(l,1) x x.^2]; % For the least squares quadratic.
>> v = B\y
v =
   -0.0423
   -0.7078
   -5.7751

>> norm(y-A*u) % The linear error.
ans =
    0.4419

>> norm( y-B*v) % The quadratic error.
ans =
    0.1171

>> s = min(x):( max(x)-min(x))/100:max(x);
>> fit = u(1) + u(2)*s;
>> fit2 = v(1) + v(2)*s + v(3)* (s.^2) ;

```

We shall plot the lines using 'r-' and 'b:' to make them solid and dotted. This will show the distinction on the black-and-white page.

```

>> plot(x,y,'w*',s,fit,'r-',s,fit2,'b:'); % 'r-', 'b:' for printing.

```

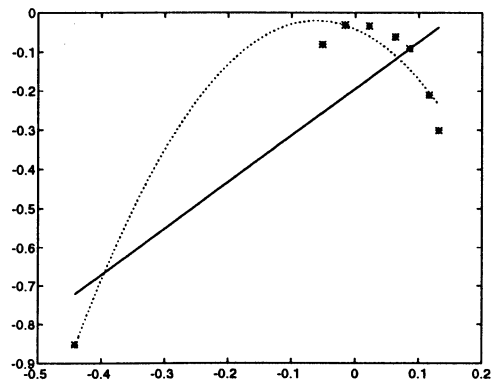

The quadratic fit is much better; the norm is smaller and the *'s are much closer to the quadratic. The original data has a parabolic shape, not a linear shape. In fact it appears that the lower left point might even be an "outlier" for the quadratic fit. (Try refitting omitting this point).

(b)

```

>> x = [.32 -0.29 .58 0.71 0.44 0.88]';
>> y = [14.16 51.3 -13.4 -29.8 19.6 -46.5]';
>> l = length(x); A = [ ones(l,1) x]; % For the least squares line.
>> u = A\y
u =
    35.9357
   -83.4296

>> B = [ ones(l,1) x x.^2]; % For the least squares quadratic.
>> v = B\y
v =
    41.5798
   -51.2577
   -59.5481

>> norm(y-A*u) % The linear error.
ans =
    25.3326

>> norm( y-B*v) % The quadratic error.
ans =
    15.2469

>> s = min(x):( max(x)-min(x))/100:max(x);
>> fit = u(1) + u(2)*s;
>> fit2 = v(1) + v(2)*s + v(3)* (s.^2) ;
>> plot(x,y,'w*',s,fit,'w-',s,fit2,'w:');

```

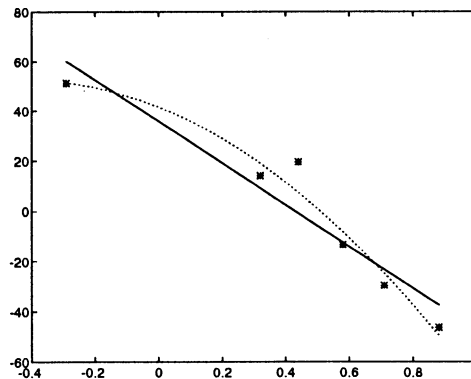

The quadratic fit is slightly better; the norm is smaller and the *'s seem closer.

6. (a)

```

>> x = [0:8]'; % Integers from 0 to 8.
>> y = [15.5 15.9 16.7 17.1 17.8 18.2 18.3 19.2 20.0]';
>> l = length(x); A = [ ones(l,1) x]; % For the least squares line.
>> u = A\y
u =
    15.4867
     0.5367

```



```
>> s = min(x):( max(x)-min(x))/100:max(x);
>> fit = u(1) + u(2)*s;
>> plot(x,y,'w*','s,fit,'w-');
```

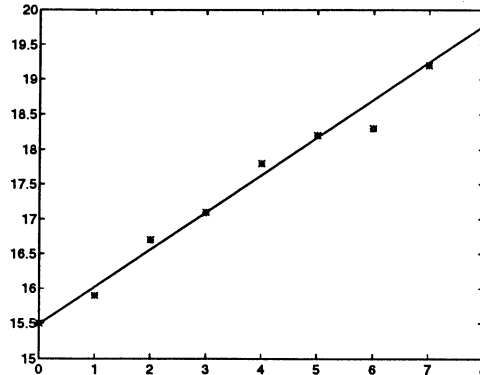

(b) Solve $15.5 + .5367x = 25$, to get 17.7 which is in 1997.

7.

```
>> x = [600 600 700 700 700 900 950 950]';
>> y = [40 44 48 46 50 48 46 45]';
>> l = length(x); A = [ ones(l,1) x]; % For the least squares line.
>> u = A\y
u =
  40.8537
   0.0066

>> B = [ ones(l,1) x x.^2]; % For the least squares quadratic.
>> v = B\y
v =
 -78.0000
   0.3200
 -0.0002

>> s = min(x):( max(x)-min(x))/100:max(x);
>> fit = u(1) + u(2)*s;
>> fit2 = v(1) + v(2)*s + v(3)*( s.^2 );
>> plot(x,y,'w*','s,fit,'w-','s,fit2,'w:');
```

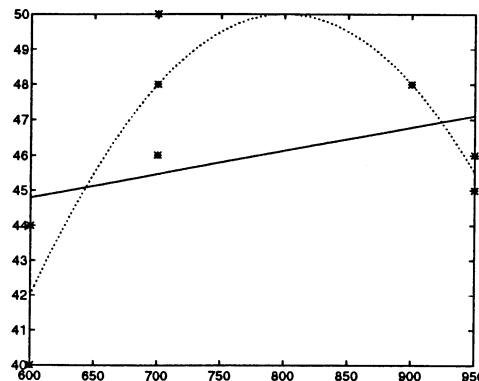

(Note the two points with $x = 600$ are obscured by labelling). The quadratic curve seems to fit better since the data seem to have a distinct upward then downward pattern. So we may recommend that the temperature be chosen at the maximum value of the quadratic,

```
>> t = -v(2)/(2*v(3))      % y=at^2+bt+c=a(t+b/2a)^2+(c-b^2/4a).
t =                          =a(t+(b/2a))^2+(c-(b^2/4a)).
    800.0000
```

(Rewriting a quadratic $y = at^2 + bt + c = a(t + \frac{b}{2a})^2 + (c - \frac{b^2}{4a})$, shows the maximum is at $t = -b/2a$, provided $a > 0$).

8.

```
>> mile
>> l = length(xm); A = [ ones(1,l) xm]; % For the least squares line.
>> u = A\ym
u =
    290.7737
    -0.3424

>> s = min(xm):(max(xm)-min(xm))/100:max(xm);
>> fit = u(1) + u(2)*s;
>> plot(xm,ym,'w*','s,fit','w-');
```

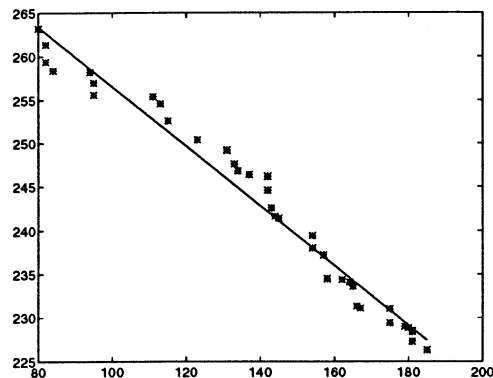

- (b) The slope is -0.3424 , so the record has decreased by .3 seconds per year on average.
(c) Solve $290.8 - .3424x = 3 * 60$:

```
>> x = (3*60 - u(1))/u(2)
x =
    323.4915
```

This is the year 2123.

9. (a)

```
>> x = [0:10]';
>> p = [5.3 7.2 9.6 12.9 17.1 23.2 31.4 38.6 50.2 62.9 76.2]';
>> y = log(p);
>> l = length(x); A = [ ones(1,l) x]; % For the least squares line.
>> u = A\y
u =
    1.7322
    0.2706
```

```
>> s = min(x):( max(x)-min(x))/100:max(x);
>> fit = u(1) + u(2)*s;
>> fite = exp(fit);
>> plot(x,p,'w*',s,fite,'w-');
```

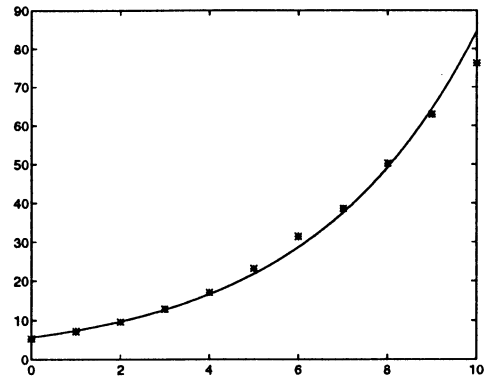

The fit appears reasonable, although the recent trend (since about 1850) seems to grow less quickly than the fitted exponential).

(ii)

```
>> exp( u(1) + 15 * u(2))      % The population in 1950.
ans =
    327.1814
```

(b) (i) The predicted population is higher than the actual population, in fact all the new population data lie well below the fitted graph in (a).

(ii) We continue the x scale from (a).

```
>> x = [11:18]';
>> p2 = [92.2 106.0 123.2 132.2 151.3 179.3 203.3 226.3]';
>> y = log(p2);
>> l = length(x); A = [ ones(1,1) x]; % For the least squares line.
>> u = A\y                          % If x=1:8 used, u(1) would be increased
u =                                  % by 10*u(2), i.e. to 3.1141+1.286=4.4001
    3.1141
    0.1286
```

```
>> s = min(x):( max(x)-min(x))/100:max(x);
>> fit = u(1) + u(2)*s;
>> fite = exp(fit);
>> plot(x,p2,'w*',s,fite,'w-');
```

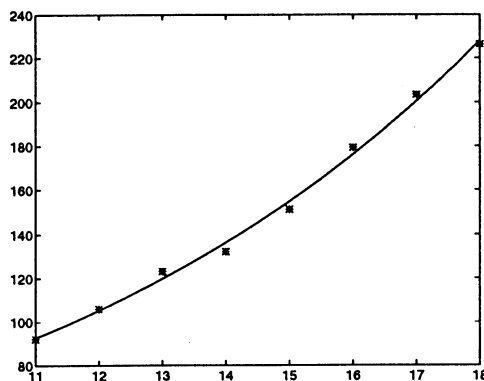

The population still looks exponential. The growth rate is the coefficient in front of the x in the exponential. From part (a) this was .27 and in part (b) it is .13, which is significantly less.

(iv) Using u from part (ii):

```
>> exp( u(1) + 20*u(2))
ans =
    294.7384
```

10.

```
>> x = [.1164 .0121 .0562 .0931 .0664 .1728 .1793 .1443 .1824]';
>> y = [.12128 .17185 .13365 .1485 .12637 .10406 .10703 .1189 .09952]';
>> l = length(x); A = [ ones(l,1) x]; % For the least squares line.
>> u = A\y
u =
    0.1645
   -0.3418
>> s = min(x):( max(x)-min(x))/100:max(x);
>> fit = u(1) + u(2)*s;
>> plot(x,y,'w*','s,fit,'w-');
```

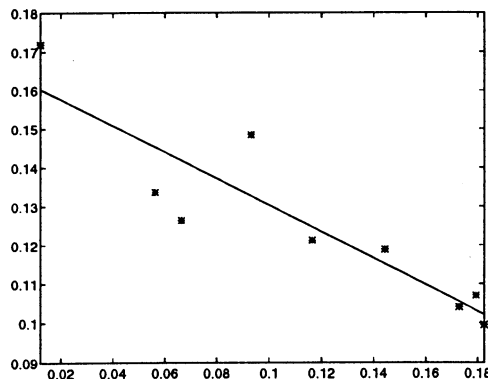

The least squares linear equation: $Fe - Mg = .1645 - .3418Ca$. This seems to fit the general pattern of the data, although the large deviations for smaller Ca values might raise some doubts.

Section 4.11

- (i) $(A, A) = a_{11}^2 + a_{22}^2 + \cdots + a_{nn}^2 \geq 0$. (ii) $(A, A) = 0$ implies $a_{ii}^2 = 0$ for each i , so $A = 0$. Conversely, if $A = 0$ then $(A, A) = 0$. (iii) $(A, B + C) = \sum_{i=1}^n a_{ii}(b_{ii} + c_{ii}) = \sum_{i=1}^n a_{ii}b_{ii} + \sum_{i=1}^n a_{ii}c_{ii} = (A, B) + (A, C)$. (iv) Similarly, $(A + B, C) = (A, C) + (B, C)$. (v) As $a_{ii}b_{ii} = b_{ii}a_{ii}$, then $(A, B) = (B, A) = \overline{(B, A)}$. (vi) $(\alpha A, B) = \sum_{i=1}^n (\alpha a_{ii})b_{ii} = \alpha \left(\sum_{i=1}^n a_{ii}b_{ii} \right) = \alpha(A, B)$. (vii) $(A, \alpha B) = (\alpha B, A) = \alpha(B, A) = \alpha(A, B) = \bar{\alpha}(A, B)$.
- Suppose $\|A\| = 1$. Then $\sqrt{(A, A)} = \sqrt{a_{11}^2 + a_{22}^2 + \cdots + a_{nn}^2} = 1$. As $(A, A) \geq 0$, then $a_{11}^2 + a_{22}^2 + \cdots + a_{nn}^2 = 1$. Conversely, if $(A, A) = 1$, then $\|A\| = 1$.
- Let E_i be the $n \times n$ matrix with 1 in the i, i position and 0 everywhere else. Then $\{E_1, E_2, \dots, E_n\}$ is an orthonormal basis for D_n .
- As $|A| = \sqrt{5}$, then $U_1 = \begin{pmatrix} 2/\sqrt{5} & 0 \\ 0 & 1/\sqrt{5} \end{pmatrix}$. $B' = B - (B, U_1)U_1 = \begin{pmatrix} -3 & 0 \\ 0 & 4 \end{pmatrix} + \frac{2}{\sqrt{5}} \begin{pmatrix} 2/\sqrt{5} & 0 \\ 0 & 1/\sqrt{5} \end{pmatrix} = \begin{pmatrix} -11/5 & 0 \\ 0 & 22/5 \end{pmatrix}$, and hence $U_2 = \begin{pmatrix} -11/\sqrt{605} & 0 \\ 0 & 22/\sqrt{605} \end{pmatrix}$.
- $\mathbf{u}_1 = (1/\sqrt{2}, i/\sqrt{2})$ and $\mathbf{v}'_2 = (2 - i, 3 + 2i) - [(2 - i, 3 + 2i) \cdot \mathbf{u}_1]\mathbf{u}_1 = (i, 1)$. So $\mathbf{u}_2 = (i/\sqrt{2}, 1/\sqrt{2})$.
- Start with the standard basis $\{1, x, x^2, x^3\}$. From example 8, $\mathbf{u}_1 = 1$, $\mathbf{u}_2 = \sqrt{3}(2x - 1)$, and $\mathbf{u}_3 = \sqrt{5}(6x^2 - 6x + 1)$. We have $(\mathbf{v}_4, \mathbf{u}_1) = \int_0^1 x^3 dx = \frac{1}{4}$, $(\mathbf{v}_4, \mathbf{u}_2) = \int_0^1 (x^3)[\sqrt{3}(2x - 1)] dx = \frac{3\sqrt{3}}{20}$, and $(\mathbf{v}_4, \mathbf{u}_3) = \int_0^1 (x^3)[\sqrt{5}(6x^2 - 6x + 1)] dx = \frac{\sqrt{5}}{20}$. Thus $\mathbf{v}'_4 = x^3 - \frac{1}{4} - \frac{3\sqrt{3}}{20}[\sqrt{3}(2x - 1)] - \frac{\sqrt{5}}{20}[\sqrt{5}(6x^2 - 6x + 1)] = x^3 - \frac{3}{2}x^2 + \frac{3}{5}x - \frac{1}{20}$, and $\|\mathbf{v}'_4\| = \left[\int_0^1 \left(x^3 - \frac{3}{2}x^2 + \frac{3}{5}x - \frac{1}{20} \right)^2 dx \right]^{1/2} = \frac{1}{20\sqrt{7}}$. Hence $\mathbf{u}_4 = 20\sqrt{7} \left(x^3 - \frac{3}{2}x^2 + \frac{3}{5}x - \frac{1}{20} \right)$.
- Start with the standard basis $\{1, x, x^2\}$. As $\int_{-1}^1 1^2 dx = 2$, then $\mathbf{u}_1 = 1/\sqrt{2}$. Since $(\mathbf{v}_2, \mathbf{u}_1) = \int_{-1}^1 x/\sqrt{2} dx = 0$, then $\mathbf{v}'_2 = \mathbf{v}_2$. As $\|\mathbf{v}'_2\| = \left[\int_{-1}^1 x^2 dx \right]^{1/2} = \sqrt{\frac{2}{3}} = \frac{2}{\sqrt{6}}$, then $\mathbf{u}_2 = \sqrt{\frac{3}{2}}x$. We have $(\mathbf{v}_3, \mathbf{u}_1) = \int_{-1}^1 x^2/\sqrt{2} dx = \sqrt{2}/3$, and $(\mathbf{v}_3, \mathbf{u}_2) = \int_{-1}^1 \sqrt{\frac{3}{2}}x^3 dx = 0$. So $\mathbf{v}'_3 = x^2 - 1/3$. $\|\mathbf{v}'_3\| = \left[\int_{-1}^1 (x^2 - 1/3)^2 dx \right]^{1/2} = \frac{1}{3}\sqrt{\frac{8}{5}}$, and hence $\mathbf{u}_3 = \sqrt{\frac{5}{8}}(3x^2 - 1)$.
- We start with the standard basis $\{1, x, x^2\}$. Since $\int_a^b 1^2 dx = b - a$, then $\mathbf{u}_1 = 1/\sqrt{b-a}$. As $(\mathbf{v}_2, \mathbf{u}_1) = \int_a^b x/\sqrt{b-a} dx = \frac{b^2 - a^2}{2\sqrt{b-a}}$, then $\mathbf{v}'_2 = x - \frac{1}{2}(b+a)$ and $\|\mathbf{v}'_2\| = \left\{ \int_a^b \left[x - \frac{1}{2}(b+a) \right]^2 dx \right\}^{1/2} = \frac{(b-a)^{3/2}}{2\sqrt{3}}$. Hence $\mathbf{u}_2 = \frac{2\sqrt{3}}{(b-a)^{3/2}} \left[x - \frac{1}{2}(b+a) \right]$. We have $(\mathbf{v}_3, \mathbf{u}_1) = \int_a^b x^2/\sqrt{b-a} dx = \frac{b^3 - a^3}{3\sqrt{b-a}}$

and $(\mathbf{v}_3, \mathbf{u}_2) = \int_a^b 2\sqrt{3}x^2 \left[x - \frac{1}{2}(b+a) \right] / (b-a)^{3/2} dx = -\frac{\sqrt{3}}{6} \frac{b^3(2a-b) + a^3(a-2b)}{(b-a)^{3/2}}$. So $\mathbf{v}'_3 = \mathbf{v}_3 - (\mathbf{v}_3, \mathbf{u}_1)\mathbf{u}_1 - (\mathbf{v}_3, \mathbf{u}_2)\mathbf{u}_2 = x^2 - (a+b)x + \frac{1}{6}(a^2 + 4ab + b^2)$ and $\|\mathbf{v}'_3\| = \frac{(b-a)^{5/2}}{6\sqrt{5}}$. Hence $\mathbf{u}_3 = \frac{6\sqrt{5}}{(b-a)^{5/2}} \left[x^2 - (a+b)x + \frac{1}{6}(a^2 + 4ab + b^2) \right]$.

9. If $A = (a_{ij})$ and $B = (b_{ij})$, then $(AB^t)_{ij} = \sum_{k=1}^n a_{ik}b_{jk}$ so that $\text{tr}(AB^t) = \sum_{i=1}^n \sum_{j=1}^n a_{ij}b_{ij}$.

(i) $(A, A) = \text{tr}(AA^t) = \sum_{i=1}^n \sum_{j=1}^n a_{ij}^2 \geq 0$.

(ii) If $\text{tr}(AA^t) = 0$, then $a_{ij}^2 = 0$ for all i and j , and hence $A = 0$. Conversely, if $A = 0$, then $(A, A) = 0$.

(iii) $(A, B+C) = \text{tr}(A(B+C)^t) = \text{tr}(A(B^t+C^t)) = \text{tr}(AB^t+AC^t) = \text{tr}(AB^t) + \text{tr}(AC^t) = (A, B) + (A, C)$.

(iv) $(A+B, C) = \text{tr}((A+B)C^t) = \text{tr}(AC^t+BC^t) = \text{tr}(AC^t) + \text{tr}(BC^t) = (A, C) + (B, C)$.

(v) $(A, B) = \text{tr}(AB^t) = \sum_{i=1}^n \sum_{j=1}^n a_{ij}b_{ij} = \sum_{i=1}^n \sum_{j=1}^n b_{ij}a_{ij} = \text{tr}(BA^t) = (B, A)$.

(vi) $(\alpha A, B) = \text{tr}((\alpha A)B^t) = \sum_{i=1}^n \sum_{j=1}^n \alpha a_{ij}b_{ij} = \alpha \sum_{i=1}^n \sum_{j=1}^n a_{ij}b_{ij} = \alpha \text{tr}(AB^t) = \alpha(A, B)$.

(vii) Similarly, $(A, \alpha B) = \alpha(A, B)$.

10. $\|A\|^2 = \text{tr}(AA^t) = \sum_{i=1}^n \sum_{j=1}^n a_{ij}^2$.

11. $\begin{pmatrix} 1 & 0 \\ 0 & 0 \end{pmatrix}, \begin{pmatrix} 0 & 1 \\ 0 & 0 \end{pmatrix}, \begin{pmatrix} 0 & 0 \\ 1 & 0 \end{pmatrix}, \begin{pmatrix} 0 & 0 \\ 0 & 1 \end{pmatrix}$.

12. (i) $(z, z) = a^2 + b^2 \geq 0$.

(ii) Suppose $(z, z) = 0$, then $a^2 + b^2 = 0$ so that $a = b = 0$. If $z = 0$ then $(z, z) = 0$.

(iii) $(z, w_1 + w_2) = a(c_1 + c_2) + b(d_1 + d_2) = ac_1 + bd_1 + ac_2 + bd_2 = (z, w_1) + (z, w_2)$.

(iv) Similarly, $(z_1 + z_2, w) = (z_1, w) + (z_2, w)$.

(v) $(z, w) = ac + bd = ba + db = (w, z)$.

(vi) $(\alpha z, w) = \alpha ac + \alpha bd = \alpha(ac + bd) = \alpha(z, w)$.

(vii) Similarly, $(z, \alpha w) = \alpha(z, w)$. Finally, $\|z\| = \sqrt{(z, z)} = \sqrt{a^2 + b^2}$.

13. (a) (i) $(p, p) = p(a)^2 + p(b)^2 + p(c)^2 \geq 0$.

(ii) If $(p, p) = 0$, then $p(a) = p(b) = p(c) = 0$. Since a quadratic equation can have at most 2 roots, then $p(x) = 0$. Conversely, if $p(x) = 0$ then $(p, p) = 0$.

(iii) $(p, q+r) = p(a)[q(a)+r(a)] + p(b)[q(b)+r(b)] + p(c)[q(c)+r(c)] = p(a)q(a) + p(b)q(b) + p(c)q(c) + p(a)r(a) + p(b)r(b) + p(c)r(c) = (p, q) + (p, r)$.

(iv) Similarly, $(p+q, r) = (p, r) + (q, r)$.

(v) $(p, q) = p(a)q(a) + p(b)q(b) + p(c)q(c) = q(a)p(a) + q(b)p(b) + q(c)p(c) = (q, p)$.

(vi) $(\alpha p, q) = \alpha p(a)q(a) + \alpha p(b)q(b) + \alpha p(c)q(c) = \alpha[p(a)q(a) + p(b)q(b) + p(c)q(c)] = \alpha(p, q)$.

(vii) Similarly, $(p, \alpha q) = \alpha(p, q)$.

(b) No, since (ii) does not hold. For example, let $a = 1$, $b = -1$, and $p(x) = (x+1)(x-1) = x^2 - 1$. Then $(p, p) = 0$, but $p \neq 0$.

14. (i) $(\mathbf{x}, \mathbf{x}) = x_1^2 + 3x_2^2 \geq 0$.
 (ii) Suppose $(\mathbf{x}, \mathbf{x}) = 0$, then $x_1^2 + 3x_2^2 = 0$, which implies $x_1 = x_2 = 0$. Conversely, if $\mathbf{x} = 0$, then $(\mathbf{x}, \mathbf{x}) = 0$.
 (iii) $(\mathbf{x}, \mathbf{y} + \mathbf{z}) = x_1(y_1 + z_1) + 3x_2(y_2 + z_2) = x_1y_1 + 3x_2y_2 + x_1z_1 + 3x_2z_2 = (\mathbf{x}, \mathbf{y}) + (\mathbf{x}, \mathbf{z})$.
 (iv) Similarly, $(\mathbf{x} + \mathbf{y}, \mathbf{z}) = (\mathbf{x}, \mathbf{z}) + (\mathbf{y}, \mathbf{z})$.
 (v) $(\mathbf{x}, \mathbf{y}) = x_1y_1 + 3x_2y_2 = y_1x_1 + 3y_2x_2 = (\mathbf{y}, \mathbf{x})$.
 (vi) $(\alpha\mathbf{x}, \mathbf{y}) = \alpha x_1y_1 + 3\alpha x_2y_2 = \alpha(x_1y_1 + 3x_2y_2) = \alpha(\mathbf{x}, \mathbf{y})$.
 (vii) Similarly, $(\mathbf{x}, \alpha\mathbf{y}) = \alpha(\mathbf{x}, \mathbf{y})$.
15. $\left\| \begin{pmatrix} 2 \\ -3 \end{pmatrix} \right\|_* = \sqrt{2^2 + 3(-3)^2} = \sqrt{31}$.
16. no; (i) $((0, 1), (0, 1)) = 0 - 1 = -1 < 0$; (ii) $((1, 1), (1, 1)) = 0$; (v) $(\mathbf{x}, \mathbf{y}) = -(\mathbf{y}, \mathbf{x})$.
17. Let λ be any real number. Then $0 \leq ((\lambda\mathbf{u} + (\mathbf{u}, \mathbf{v})\mathbf{v}), (\lambda\mathbf{u} + (\mathbf{u}, \mathbf{v})\mathbf{v})) = (\lambda\mathbf{u}, \lambda\mathbf{u}) + (\lambda\mathbf{u}, (\mathbf{u}, \mathbf{v})\mathbf{v}) + ((\mathbf{u}, \mathbf{v})\mathbf{v}, \lambda\mathbf{u}) + ((\mathbf{u}, \mathbf{v})\mathbf{v}, (\mathbf{u}, \mathbf{v})\mathbf{v}) = (\mathbf{u}, \mathbf{u})\lambda^2 + \lambda(\mathbf{u}, \mathbf{v})(\mathbf{u}, \mathbf{v}) + \lambda(\mathbf{u}, \mathbf{v})(\mathbf{v}, \mathbf{u}) + (\mathbf{u}, \mathbf{v})(\mathbf{u}, \mathbf{v})(\mathbf{v}, \mathbf{v}) = \|\mathbf{u}\|^2\lambda^2 + 2|(\mathbf{u}, \mathbf{v})|^2\lambda + |(\mathbf{u}, \mathbf{v})|^2\|\mathbf{v}\|^2$. The last line is a quadratic equation in λ . If we have $a\lambda^2 + b\lambda + c \geq 0$ then $a\lambda^2 + b\lambda + c = 0$ has at most one real root, and hence $b^2 - 4ac \leq 0$. Thus, $4|(\mathbf{u}, \mathbf{v})|^4 - 4\|\mathbf{u}\|^2|(\mathbf{u}, \mathbf{v})|^2\|\mathbf{v}\|^2 \leq 0$. So $|(\mathbf{u}, \mathbf{v})|^2 \leq \|\mathbf{u}\|^2\|\mathbf{v}\|^2$. Taking square roots, we obtain $|(\mathbf{u}, \mathbf{v})| \leq \|\mathbf{u}\|\|\mathbf{v}\|$.
18. $\|\mathbf{u} + \mathbf{v}\|^2 = (\mathbf{u} + \mathbf{v}) \cdot (\mathbf{u} + \mathbf{v}) = (\mathbf{u}, \mathbf{u}) + (\mathbf{u}, \mathbf{v}) + \overline{(\mathbf{u}, \mathbf{v})} + (\mathbf{v}, \mathbf{v}) = \|\mathbf{u}\|^2 + 2\operatorname{Re}(\mathbf{u}, \mathbf{v}) + \|\mathbf{v}\|^2$. By the Cauchy-Schwarz inequality, we have $\sqrt{\operatorname{Re}(\mathbf{u}, \mathbf{v})^2 + \operatorname{Im}(\mathbf{u}, \mathbf{v})^2} \leq |\mathbf{u}||\mathbf{v}|$, so that $\operatorname{Re}(\mathbf{u}, \mathbf{v}) \leq \|\mathbf{u}\|\|\mathbf{v}\|$. Hence $\|\mathbf{u} + \mathbf{v}\|^2 \leq \|\mathbf{u}\|^2 + 2\|\mathbf{u}\|\|\mathbf{v}\| + \|\mathbf{v}\|^2 = (\|\mathbf{u}\| + \|\mathbf{v}\|)^2$. Taking square roots, we obtain $\|\mathbf{u} + \mathbf{v}\| \leq \|\mathbf{u}\| + \|\mathbf{v}\|$.
19. By definition, $H^\perp = \{p \in P_3[0, 1] : (p, h) = 0 \text{ for every } h \in H\}$. Let $p(x) = ax^3 + bx^2 + cx + d \in P_3[0, 1]$. We want to find conditions on a, b, c , and d such that $p(x) \in H^\perp$. We have $(p, x^2) = \int_0^1 (ax^3 + bx^2 + cx + d)x^2 dx = \frac{a}{6} + \frac{b}{5} + \frac{c}{4} + \frac{d}{3} = 0$, and $(p, 1) = \int_0^1 (ax^3 + bx^2 + cx + d) dx = \frac{a}{4} + \frac{b}{3} + \frac{c}{2} + d = 0$. Upon solving this system of equations, we obtain $\{(0, -15, 16, -3), (20, -30, 12, -1)\}$ for a basis of the solution space. Hence, $H^\perp = \operatorname{span}\{-15x^2 + 16x - 3, 20x^3 - 30x^2 + 12x - 1\}$.
20. To show the orthogonal complement of the even functions, $H = \{f \in C[-1, 1] : f(-x) = f(x)\}$, is the set of odd functions, $\{g \in C[-1, 1] : g(-x) = -g(x)\}$, observe that for any odd $g(x) \int_{-1}^1 g(x) dx = 0$. This follows by applying the change of variables, $x = -z$ to the integral and applying the definition of *oddness*. Now for any odd g and even f , $f(-x)g(-x) = f(x)(-g(x)) = -(f(x)g(x))$, i.e. fg is odd. Hence $(f, g) = \int_{-1}^1 (fg)(x) dx = 0$. Thus $\text{odds} \subseteq H^\perp$.
 Conversely, suppose $g \in H^\perp$. Write $g(x) = \frac{1}{2}(g(x) + g(-x)) + \frac{1}{2}(g(x) - g(-x)) = g_e(x) + g_o(x)$, where g_e is even, i.e. in H , and g_o is odd. Then since $g \in H^\perp$, $(g, g_e) = 0$, which implies $0 = (g_e + g_o, g_e) = (g_e, g_e) + (g_o, g_e) = (g_e, g_e)$ as the odd function $g_o \in H^\perp$. But this says $\|g_e\|^2 = 0$, so $g_e = 0$. Hence $g = g_o$, i.e. g is odd. So $H^\perp \subseteq \text{odds}$ and we are done. (It is much cleaner to write out all of this using the inner product notation rather than putting in the definite integrals.)
21. We have $\{1, \sqrt{3}(2x - 1), \sqrt{5}(6x^2 - 6x + 1)\}$ for an orthonormal basis of H . As $(\mathbf{v}, \mathbf{u}_1) = \int_0^1 (1 + 2x + 3x^2 - x^3) dx = \frac{11}{4}$, $(\mathbf{v}, \mathbf{u}_2) = \int_0^1 (1 + 2x + 3x^2 - x^3)\sqrt{3}(2x - 1) dx = \frac{41\sqrt{3}}{60}$, and $(\mathbf{v}, \mathbf{u}_3) = \int_0^1 (1 + 2x + 3x^2 - x^3)\sqrt{5}(6x^2 - 6x + 1) dx = \frac{\sqrt{5}}{20}$, then $\operatorname{proj}_H \mathbf{v} = \frac{3}{2}x^2 + \frac{13}{5}x + \frac{19}{20}$. Note that $\operatorname{proj}_H \mathbf{v} - \mathbf{v}$ is orthogonal to H , so an orthonormal basis for H^\perp is $\left\{20\sqrt{7} \left(x^3 - \frac{3}{2}x^2 + \frac{3}{5}x - \frac{1}{20}\right)\right\}$. As $\int_0^1 (1 +$

$$2x+3x^2-x^3)20\sqrt{7}\left(x^3-\frac{3}{2}x^2+\frac{3}{5}x-\frac{1}{20}\right)dx = \frac{-\sqrt{7}}{140}, \text{ hence } 1+2x+3x^2-x^3 = \left(\frac{3}{2}x^2+\frac{13}{5}x+\frac{19}{20}\right) + \frac{-\sqrt{7}}{140}20\sqrt{7}\left(x^3-\frac{3}{2}x^2+\frac{3}{5}x-\frac{1}{20}\right) = \left(\frac{3}{2}x^2+\frac{13}{5}x+\frac{19}{20}\right) + \left(-x^3+\frac{3}{2}x^2-\frac{3}{5}x+\frac{1}{20}\right).$$

22. We want to calculate $\text{proj}_{P_2[0,1]}\sin\frac{\pi}{2}x$. Since $\{1, \sqrt{3}(2x-1), \sqrt{5}(6x^2-6x+1)\}$ is an orthonormal basis for $P_2[0,1]$. We have $\text{proj}_{P_2[0,1]}\sin\frac{\pi}{2}x = \left(\sin\frac{\pi}{2}x, 1\right) + \left(\sin\frac{\pi}{2}x, \sqrt{3}(2x-1)\right)\sqrt{3}(2x-1) + \left(\sin\frac{\pi}{2}x, \sqrt{5}(6x^2-6x+1)\right)\sqrt{5}(6x^2-6x+1)$. Since $\left(\sin\frac{\pi}{2}x, 1\right) = \int_0^1 \sin\frac{\pi}{2}x dx = \frac{2}{\pi}$, $\left(\sin\frac{\pi}{2}x, \sqrt{3}(2x-1)\right) = \int_0^1 \left(\sin\frac{\pi}{2}x\right)\sqrt{3}(2x-1) dx = \frac{2\sqrt{3}}{\pi}(\pi-4)$, using integration by parts and $\left(\sin\frac{\pi}{2}x, \sqrt{5}(6x^2-6x+1)\right) = \int_0^1 \left(\sin\frac{\pi}{2}x\right)\sqrt{5}(6x^2-6x+1) dx = \frac{2\sqrt{5}}{\pi^3}(\pi^2+12\pi-48)$, then $\text{proj}_{P_2[0,1]}\sin\frac{\pi}{2}x = \frac{6}{\pi^3}[(10\pi^2+120\pi-480)x^2 + (-12\pi^2-112\pi+480)x + 3\pi^2+16\pi-80]$.
23. We want to calculate $\text{proj}_{P_2[0,1]}\cos\frac{\pi}{2}x$. Since $\{1, \sqrt{3}(2x-1), \sqrt{5}(6x^2-6x+1)\}$ is an orthonormal basis for $P_2[0,1]$, we have $\left(\cos\frac{\pi}{2}x, 1\right) = \int_0^1 \cos\frac{\pi}{2}x dx = \frac{2}{\pi}$, $\left(\cos\frac{\pi}{2}x, \sqrt{3}(2x-1)\right) = \int_0^1 \left(\cos\frac{\pi}{2}x\right)\sqrt{3}(2x-1) dx = \frac{2\sqrt{3}}{\pi^2}(\pi-4)$, and $\left(\cos\frac{\pi}{2}x, \sqrt{5}(6x^2-6x+1)\right) = \int_0^1 \left(\cos\frac{\pi}{2}x\right)\sqrt{5}(6x^2-6x+1) dx = \frac{2\sqrt{5}}{\pi^3}(\pi^2+12\pi-48)$. Hence, $\text{proj}_{P_2[0,1]}\cos\frac{\pi}{2}x = \frac{6}{\pi^3}[(10\pi^2+120\pi-480)x^2 + (-8\pi^2-128\pi+480)x + \pi^2+24\pi-80]$.
24. $A^* = \begin{pmatrix} 1+2i & -2i \\ 3-4i & -6 \end{pmatrix}$
25. $A^* = \begin{pmatrix} 1/\sqrt{2} & 1/\sqrt{2} \\ -1/2-i/2 & 1/2+i/2 \end{pmatrix}$; $AA^* = I$.
26. Suppose \mathbf{a} is the i^{th} column of A , $i = 1, 2, \dots, n$. We have $A^*A = B$ where $b_{ij} = \mathbf{a}_i^* \cdot \mathbf{a}_j = \overline{(\mathbf{a}_i, \mathbf{a}_j)}$. Then A is unitary if and only if $B = I$, i.e. $b_{ij} = 1$ if $i = j$ and $b_{ij} = 0$ if $i \neq j$. Hence, A is unitary if and only if the columns of A constitute an orthonormal basis for \mathbb{C}^n .
27. (i) $(f, f) = \int_a^b f(x)\overline{f(x)} dx \geq 0$ since $f(x)\overline{f(x)} \geq 0$. (ii) Suppose $(f, f) = \int_a^b f(x)\overline{f(x)} dx = 0$. As $f(x)\overline{f(x)} = f_1^2(x) + f_2^2(x) \geq 0$ for all $x \in [a, b]$ and $f \in CV[a, b]$, then $f(x) = 0$ on $[a, b]$. Conversely, if $f(x) = 0$ on $[a, b]$, then $(f, f) = 0$. (iii) $(f, g+h) = \int_a^b f(x)[\overline{g(x)+h(x)}] dx = \int_a^b f(x)[\overline{g(x)}+\overline{h(x)}] dx = \int_a^b f(x)\overline{g(x)} dx + \int_a^b f(x)\overline{h(x)} dx = (f, g) + (f, h)$. (iv) Similarly, $(f+g, h) = (f, h) + (g, h)$. (v) $(f, g) = \int_a^b f(x)\overline{g(x)} dx = \int_a^b \overline{\overline{f(x)}g(x)} dx = \overline{\int_a^b g(x)\overline{f(x)} dx} = \overline{(g, f)}$. (vi) $(\alpha f, g) = \int_a^b \alpha f(x)\overline{g(x)} dx = \alpha \int_a^b f(x)\overline{g(x)} dx = \alpha(f, g)$. (vii) Similarly, $(f, \alpha g) = \overline{\alpha}(f, g)$.
28. $\int_0^\pi f(x)\overline{g(x)} dx = \int_0^\pi (\sin^2 x - \cos^2 x + 2i \sin x \cos x) dx = \int_0^\pi \cos 2x dx + i \int_0^\pi \sin 2x dx = 0 + 0 = 0$.

$$29. \|\sin x + i \cos x\| = \left[\int_0^\pi (\sin^2 x + \cos^2 x) dx \right]^{1/2} = \sqrt{\pi}.$$

MATLAB 4.11

1.

```

>> v1 = 2*rand(4,1)-1 + i*(2*rand(4,1)-1); % Generate the vectors.
>> v2 = 2*rand(4,1)-1 + i*(2*rand(4,1)-1);
>> v3 = 2*rand(4,1)-1 + i*(2*rand(4,1)-1);
>> v4 = 2*rand(4,1)-1 + i*(2*rand(4,1)-1);
>> u1 = v1/ norm(v1); % Gram-Schmidt.
>> u2 = v2 - (u1'*v2)*u1; % Notice that this is not (v2'*u1).
>> u2 = u2 / norm(u2) ;
>> u3 = v3 - (u1'*v3)*u1 - (u2'*v3)*u2 ;
>> u3 = u3 / norm(u3) ;
>> u4 = v4 - (u1'*v4)*u1 - (u2'*v4)*u2 - (u3'*v4)*u3 ;
>> u4 = u4 / norm(u4) ;
>> A = [u1 u2 u3 u4]; % To verify that they are orthonormal:
>> norm(eye(4) - A' * A) % This should be zero, up to round-off.
ans =
    3.9196e-15
>> norm([v1 v2 v3 v4] - A*(A'*[v1 v2 v2 v3])) % zero up to roundoff
ans =
    5.3276e-15 % each vi is a linear combination of uj's.

```

2. (a)

```

>> w = 2*rand(4,1)-1 + i*(2*rand(4,1)-1);
>> w - ((u1'*w)*u1 + (u2'*w)*u2 + (u3'*w)*u3 + (u4'*w)*u4) % This should be zero.
ans =
    1.0e-14 *
   -0.0777 + 0.0222i
    0.0541 + 0.1499i
   -0.2887 + 0.1998i
   -0.0777 + 0.1554i
>> w - A*(A'*w) % This is another way to check the same fact.
ans =
    1.0e-14 *
   -0.0888
    0.0500 + 0.1478i
   -0.2887 + 0.1998i
   -0.0722 + 0.1554i

```

(b) Every vector \mathbf{w} in \mathbb{C}^n is a linear combination of the vectors \mathbf{u}_i in an orthonormal basis. In fact, the i th coordinate of \mathbf{w} is $(\mathbf{w}, \mathbf{u}_i) (= \mathbf{u}_i' * \mathbf{w})$.

3.

```

>> v1 = 2*rand(6,1)-1 + i*(2*rand(6,1)-1); % Generate the vectors.
>> v2 = 2*rand(6,1)-1 + i*(2*rand(6,1)-1);
>> v3 = 2*rand(6,1)-1 + i*(2*rand(6,1)-1);
>> v4 = 2*rand(6,1)-1 + i*(2*rand(6,1)-1);
>> A = [v1 v2 v3 v4]; B = orth(A); u1=B(:,1); u2=B(:,2);
    u3=B(:,3); u4=B(:,4);

```

(a)

```

>> w = 2*rand(6,1)-1 + i*(2*rand(6,1)-1);

>> p = (u1'*w)*u1+(u2'*w)*u2+(u3'*w)*u3+(u4'*w)*u4 % Project w onto H.
p =
   -0.5014 + 0.6019i
    0.2835 + 0.1884i
    0.9411 + 0.3912i
   -0.0977 + 0.2916i
    0.5543 - 0.7369i
    0.5884 + 0.5017i
>> z = [u1'*w u2'*w u3'*w u4'*w]' % Note (w,ui)=ui'*w in the complex case
z = % and p = B*z from the formula for p
   -0.7047 + 0.7876i
   -0.7063 + 0.9850i
    0.8179 + 0.2196i
   -0.0638 - 0.0596i

>> B'*w % This will agree with z by the definitions of ui and z
ans =
   -0.7047 + 0.7876i
   -0.7063 + 0.9850i
    0.8179 + 0.2196i
   -0.0638 - 0.0596i
>> B*(B'*w) % Substitute z=B'*w in p=B*z to see why this is p
ans =
   -0.5014 + 0.6019i
    0.2835 + 0.1884i
    0.9411 + 0.3912i
   -0.0977 + 0.2916i
    0.5543 - 0.7369i
    0.5884 + 0.5017i

```

(b)

```

>> x = 2*rand(4,1)-1 + i*(2*rand(4,1)-1);
>> h = A*x % h is in H.
h =
    1.2117 - 0.2441i
    0.1575 + 0.1130i
   -0.9003 - 0.9038i
    0.2202 - 1.0490i
   -0.5889 - 0.1895i
   -0.5081 - 1.5998i

>> norm(w-h), norm(w-p) % Compare.
ans =
    4.2915
ans =
    0.7440

```

The projection of w on H is the vector in H closest to w .

(c) Since \mathbf{v}_4 is a linear combination of \mathbf{v}_1 , \mathbf{v}_3 and \mathbf{z} , it may be replaced by \mathbf{z} in the basis.

```
>> z = A * [ 2; 0; -3; 1];
>> C = [ A(:, [1:3]) z]; D = orth(C);
>> w = 10*(2*rand(6,1)-1);
>> p1 = B*B'*w;           % Use basis B.
>> p2 = D*D'*w;           % Use basis D.
>> p1 - p2                 % Compare
```

```
ans =
  1.0e-13 *
  0.2132 - 0.2021i
 -0.0444 + 0.0200i
 -0.1599 + 0.1354i
 -0.0797 + 0.2792i
  0.0622 - 0.0311i
  0.1954 - 0.0133i
```

The projection of \mathbf{w} onto H should not depend on which basis you choose. Here, $\mathbf{p}_1 - \mathbf{p}_2$ is zero up to round-off error.

4. (a) See MATLAB 4.9 problem 8, replacing t by i throughout.
(b)

```
>> A = (2*rand(7,4)-1) + i*(2*rand(7,4)-1);
>> B = orth(A); C = null(A');
>> C'*C           % Verify that columns of C are orthonormal.
ans =
  1.0000          0.0000 - 0.0000i    0.0000 - 0.0000i
  0.0000 + 0.0000i    1.0000          0.0000 - 0.0000i
  0.0000 + 0.0000i    0.0000 + 0.0000i    1.0000
```

(c)

```
>> w = (2*rand(7,1)-1) + i*(2*rand(7,1)-1);
```

Use $\text{proj}_H \mathbf{w} = B * B' \mathbf{w}$ from Problem 3(a). Also note that columns of C are an orthonormal basis for H^\perp , by part (a) of this problem. So

```
>> h = B*B'*w; p = C*C'*w; % Using projection formula in Problem 3(a)
>> w - (h+p)               % This should be zero (up to round off).
ans =
  1.0e-15 *
  0.1110 + 0.6106i
 -0.3331
 -0.4441 + 0.1110i
  0.2220 - 0.1110i
  0.1110 - 0.1665i
 -0.2220 + 0.1110i
 -0.0555 + 0.1110i

>> h'*p                     % h, p essentially orthogonal
ans =
 -1.7347e-16- 2.2204e-16i
```

5. (a)

```

>> A1 = (2*rand(4)-1) + i*(2*rand(4)-1);
>> A2 = (2*rand(4)-1) + i*(2*rand(4)-1);
>> Q1 = orth(A1); Q2 = orth(A2);
>> norm(Q1'*Q1 - eye(4)) % This should be zero:
ans =
    5.7132e-16
>> norm(Q2'*Q2 - eye(4)) % This also should be zero.
ans =
    6.8807e-16

```

Since the matrices are unitary, their columns are orthonormal, and hence linearly independent. Since there are four columns, they must form a basis for \mathbb{C}^4 .

(b)

```

>> A = inv(Q1);
>> norm(A'*A - eye(4)) % This should be zero.
ans =
    4.7682e-16
>> A = inv(Q2);
>> norm(A'*A - eye(4)) % This should be zero.
ans =
    7.2160e-16

```

(c)

```

>> A = Q1*Q2;
>> norm(A'*A - eye(4)) % This should be zero.
ans =
    9.2361e-16

```

(d)

```

>> v = (2*rand(4,1)-1) + i*(2*rand(4,1)-1); % Part (d)>
>> norm(v) - norm(Q1*v) % This should be zero.
ans =
    6.6613e-16
>> norm(v) - norm(Q2*v) % This should be zero.
ans =
    8.8818e-16

```

(e) Repeat above for two random 6×6 .

Section 4.12

1. Let S be a set of linearly independent elements of V . If S is maximal, S forms a basis by Theorem 1 and we are done. If not, then there exists $\mathbf{v}_1 \in V$ such that $\mathbf{v}_1 \notin \text{span } S$. Then if $S \cup \{\mathbf{v}_1\}$ is maximal, we are finished by Theorem 1. Otherwise, we continue the process. The process must stop with a maximal set of linearly independent elements $S \cup \{\mathbf{v}_1, \dots, \mathbf{v}_m\}$. This gives a basis for V .
2. Let S be a set such that $V \subseteq \text{span } S$. Choose $\mathbf{v}_1 \in S$. If $\{\mathbf{v}_1\}$ is not a basis of V , we can find $\mathbf{v}_2 \in S$ such that $\mathbf{v}_2 \notin \text{span } \{\mathbf{v}_1\}$. Then \mathbf{v}_1 and \mathbf{v}_2 are independent and if $\{\mathbf{v}_1, \mathbf{v}_2\}$ is maximal, we are finished by Theorem 1. Otherwise, we continue the process. The process must stop with a maximal set of linearly independent elements $\{\mathbf{v}_1, \dots, \mathbf{v}_m\} \subseteq S$. This gives us a basis for V .
3. Because T is a chain, either $A_1 \subseteq A_2$ or $A_2 \subseteq A_1$. So the result is true if $n = 2$. Suppose the result is true for $n - 1$ sets in a chain T . Then for A_1, \dots, A_{n-1} , one of the sets, say A_k , contains all of the others. Then consider the n sets A_1, \dots, A_{n-1}, A_n . Then either $A_k \subseteq A_n$ or $A_n \subseteq A_k$. If $A_k \subseteq A_n$, then A_n contains all of the other sets. If $A_n \subseteq A_k$, then A_k contains all of the other sets. Then, by mathematical induction, given n sets in a chain T , one of the sets contains all the others.

Review Exercises for Chapter 4

1. yes; Basis: $\left\{ \begin{pmatrix} -2 \\ 1 \\ 0 \end{pmatrix}, \begin{pmatrix} 1 \\ 0 \\ 1 \end{pmatrix} \right\}$; dimension = 2.
2. no; if (x, y, z) satisfies $x + 2y - z < 0$ then $(-x, -y, -z)$ satisfies $x + 2y - z > 0$.
3. yes; Basis: $\left\{ \begin{pmatrix} -1 \\ 1 \\ 0 \\ 0 \end{pmatrix}, \begin{pmatrix} -1 \\ 0 \\ 1 \\ 0 \end{pmatrix}, \begin{pmatrix} -1 \\ 0 \\ 0 \\ 1 \end{pmatrix} \right\}$; dimension = 3.
4. no; $(1, -4, 3)$ satisfies the equation but $(-1, 4, -3)$ does not.
5. yes; Basis: $(E_{ij} : j \geq i)$, where E_{ij} is the matrix with 1 in the i, j position and 0 elsewhere; dimension = $n(n+1)/2$.
6. yes; Basis: $\{1, x, x^2, x^3, x^4, x^5\}$; dimension = 6.
7. no; $(x^5 + 1) + (-x^5 + 1) = 2$; not closed under addition.
8. yes; Basis: $\left\{ \begin{pmatrix} 1 & 0 \\ 0 & 0 \\ 0 & 0 \end{pmatrix}, \begin{pmatrix} 0 & 0 \\ 1 & 0 \\ 0 & 0 \end{pmatrix}, \begin{pmatrix} 0 & 0 \\ 0 & 1 \\ 0 & 0 \end{pmatrix}, \begin{pmatrix} 0 & 0 \\ 0 & 0 \\ 1 & 0 \end{pmatrix}, \begin{pmatrix} 0 & 0 \\ 0 & 0 \\ 0 & 1 \end{pmatrix} \right\}$; dimension = 5.
9. no; $\begin{pmatrix} 0 & 1 \\ 0 & 0 \\ 0 & 0 \end{pmatrix} + \begin{pmatrix} 0 & 1 \\ 0 & 0 \\ 0 & 0 \end{pmatrix} = \begin{pmatrix} 0 & 2 \\ 0 & 0 \\ 0 & 0 \end{pmatrix}$; not closed under addition.
10. yes; infinite dimensional.
11. $\begin{vmatrix} 2 & 4 \\ 3 & -6 \end{vmatrix} = -24 \Rightarrow$ linearly independent.
12. $\begin{vmatrix} 2 & 4 \\ 3 & 6 \end{vmatrix} = 0 \Rightarrow$ linearly dependent.
13. $\begin{vmatrix} 1 & 3 & 0 \\ -1 & 0 & 0 \\ 2 & 1 & 0 \end{vmatrix} = 0 \Rightarrow$ linearly dependent.
14. $\begin{vmatrix} 1 & 0 & 2 \\ -4 & 2 & -10 \\ 2 & -1 & 5 \end{vmatrix} = 0 \Rightarrow$ linearly dependent.
15. $\begin{vmatrix} 1 & 0 & 0 & 0 \\ 0 & 1 & 0 & 0 \\ 0 & 0 & 1 & 0 \\ 0 & 0 & 0 & 1 \end{vmatrix} = 1 \Rightarrow$ linearly dependent.
16. $\begin{vmatrix} 1 & 2 & 3 & 0 \\ 0 & 0 & -1 & -8 \\ 0 & -1 & 0 & 7 \\ 0 & 0 & 0 & 0 \end{vmatrix} = 0 \Rightarrow$ linearly dependent.
17. $\begin{vmatrix} 1 & 2 & 3 & 0 \\ 0 & 0 & -1 & -8 \\ 0 & 0 & 0 & 7 \\ 0 & 1 & 0 & 0 \end{vmatrix} = -7 \Rightarrow$ linearly independent.
18. $\begin{vmatrix} 1 & 1 & 0 & 0 \\ -1 & 1 & 0 & 0 \\ 0 & 0 & 1 & 1 \\ 0 & 0 & 1 & -1 \end{vmatrix} = -4 \Rightarrow$ linearly independent.
19. $\begin{vmatrix} 1 & 1 & 0 & 0 \\ 1 & -1 & 0 & 0 \\ 0 & 0 & 1 & 1 \\ 0 & 0 & 1 & -1 \end{vmatrix} = 4 \Rightarrow$ linearly independent.
20. (a) $\begin{vmatrix} 1 & 3 & -5 \\ 5 & 0 & 5 \\ 2 & 4 & 6 \end{vmatrix} = -180 \Rightarrow$ linearly independent.
- (b) $\begin{vmatrix} 2 & 3 & -1 \\ 1 & -2 & -4 \\ 4 & 6 & -2 \end{vmatrix} = 0 \Rightarrow$ linearly dependent.

21. $x = 2z - 3y/2$ Basis: $\left\{ \begin{pmatrix} -3/2 \\ 1 \\ 0 \end{pmatrix}, \begin{pmatrix} 2 \\ 0 \\ 1 \end{pmatrix} \right\}$; dimension = 2.

22. $y = 2x/3$ Basis: $\left\{ \begin{pmatrix} 3 \\ 2 \end{pmatrix} \right\}$; dimension = 1.

23. $y = 3x - z + w$ Basis: $\left\{ \begin{pmatrix} 1 \\ 0 \\ 1 \\ 0 \end{pmatrix}, \begin{pmatrix} 0 \\ 1 \\ 3 \\ 0 \end{pmatrix}, \begin{pmatrix} 0 \\ 0 \\ -1 \\ 1 \end{pmatrix} \right\}$; dimension = 3.

24. Basis: $\{x, x^2, x^3\}$; dimension = 3.

25. Basis: $\left\{ \begin{pmatrix} 1 & 0 & 0 & 0 \\ 0 & 0 & 0 & 0 \\ 0 & 0 & 0 & 0 \\ 0 & 0 & 0 & 0 \end{pmatrix}, \begin{pmatrix} 0 & 0 & 0 & 0 \\ 0 & 1 & 0 & 0 \\ 0 & 0 & 0 & 0 \\ 0 & 0 & 0 & 0 \end{pmatrix}, \begin{pmatrix} 0 & 0 & 0 & 0 \\ 0 & 0 & 0 & 0 \\ 0 & 0 & 1 & 0 \\ 0 & 0 & 0 & 0 \end{pmatrix}, \begin{pmatrix} 0 & 0 & 0 & 0 \\ 0 & 0 & 0 & 0 \\ 0 & 0 & 0 & 0 \\ 0 & 0 & 0 & 1 \end{pmatrix} \right\}$; dimension = 4.

26. Basis: $\left\{ \begin{pmatrix} 1 & 0 \\ 0 & 0 \\ 0 & 0 \end{pmatrix}, \begin{pmatrix} 0 & 1 \\ 0 & 0 \\ 0 & 0 \end{pmatrix}, \begin{pmatrix} 0 & 0 \\ 1 & 0 \\ 0 & 0 \end{pmatrix}, \begin{pmatrix} 0 & 0 \\ 0 & 1 \\ 0 & 0 \end{pmatrix}, \begin{pmatrix} 0 & 0 \\ 0 & 0 \\ 1 & 0 \end{pmatrix}, \begin{pmatrix} 0 & 0 \\ 0 & 0 \\ 0 & 1 \end{pmatrix} \right\}$; dimension = 6.

27. $\begin{pmatrix} 1 & -2 \\ -2 & 4 \end{pmatrix} \rightarrow \begin{pmatrix} 1 & -2 \\ 0 & 0 \end{pmatrix}$; $N_A = \text{span} \left\{ \begin{pmatrix} 2 \\ 1 \end{pmatrix} \right\}$, $\nu(A) = 1$, $\text{Range } A = \text{span} \left\{ \begin{pmatrix} 1 \\ -1 \end{pmatrix} \right\}$, $\rho(A) = 1$.

28. $\begin{pmatrix} 1 & -1 & 3 \\ 2 & 0 & 4 \\ 0 & -2 & 2 \end{pmatrix} \rightarrow \begin{pmatrix} 1 & -1 & 3 \\ 0 & 2 & -2 \\ 0 & -2 & 2 \end{pmatrix} \rightarrow \begin{pmatrix} 1 & 0 & 2 \\ 0 & 1 & -1 \\ 0 & 0 & 0 \end{pmatrix}$; $N_A = \text{span} \left\{ \begin{pmatrix} -2 \\ 1 \\ 1 \end{pmatrix} \right\}$, $\nu(A) = 1$, $\text{Range } A = \text{span} \left\{ \begin{pmatrix} 1 \\ 2 \\ 0 \end{pmatrix}, \begin{pmatrix} -1 \\ 0 \\ -2 \end{pmatrix} \right\}$, $\rho(A) = 2$.

29. $\begin{pmatrix} 1 & -1 & 2 \\ 0 & 1 & 4 \\ 1 & -1 & 0 \end{pmatrix} \rightarrow \begin{pmatrix} 1 & -1 & 2 \\ 0 & 1 & 4 \\ 0 & 0 & 2 \end{pmatrix} \rightarrow \begin{pmatrix} 1 & 0 & 0 \\ 0 & 1 & 0 \\ 0 & 0 & 1 \end{pmatrix}$; $N_A = \{\mathbf{0}\}$, $\nu(A) = 0$,

$\text{Range } A = \text{span} \left\{ \begin{pmatrix} 1 \\ 0 \\ 1 \end{pmatrix}, \begin{pmatrix} -1 \\ 1 \\ -1 \end{pmatrix}, \begin{pmatrix} 2 \\ 4 \\ 0 \end{pmatrix} \right\}$, $\rho(A) = 3$.

30. $\begin{pmatrix} 2 & 4 & -2 \\ -1 & -2 & 1 \end{pmatrix} \rightarrow \begin{pmatrix} 1 & 2 & -1 \\ 0 & 0 & 0 \end{pmatrix}$; $N_A = \text{span} \left\{ \begin{pmatrix} -2 \\ 1 \\ 0 \end{pmatrix}, \begin{pmatrix} 1 \\ 0 \\ 1 \end{pmatrix} \right\}$, $\nu(A) = 2$,

$\text{Range } A = \text{span} \left\{ \begin{pmatrix} 2 \\ -1 \end{pmatrix} \right\}$, $\rho(A) = 1$.

31. $\begin{pmatrix} 2 & 3 \\ -1 & 2 \\ 4 & 6 \end{pmatrix} \rightarrow \begin{pmatrix} -1 & 2 \\ 0 & 7 \\ 0 & 14 \end{pmatrix} \rightarrow \begin{pmatrix} 1 & 0 \\ 0 & 1 \\ 0 & 0 \end{pmatrix}$; $N_A = \{\mathbf{0}\}$, $\nu(A) = 0$, $\text{Range } A = \text{span} \left\{ \begin{pmatrix} 2 \\ -1 \\ 4 \end{pmatrix}, \begin{pmatrix} 3 \\ 2 \\ 6 \end{pmatrix} \right\}$,
 $\rho(A) = 2$.

$$32. \begin{pmatrix} 1 & -1 & 2 & 3 \\ 0 & 1 & -1 & 0 \\ 1 & -2 & 3 & 3 \\ 2 & -3 & 5 & 6 \end{pmatrix} \rightarrow \begin{pmatrix} 1 & -1 & 2 & 3 \\ 0 & 1 & -1 & 0 \\ 0 & 1 & -1 & 0 \\ 0 & 1 & -1 & 0 \end{pmatrix} \rightarrow \begin{pmatrix} 1 & 0 & 1 & 3 \\ 0 & 1 & -1 & 0 \\ 0 & 0 & 0 & 0 \\ 0 & 0 & 0 & 0 \end{pmatrix}; N_A = \text{span} \left\{ \begin{pmatrix} -1 \\ 1 \\ 1 \\ 0 \end{pmatrix}, \begin{pmatrix} -3 \\ 0 \\ 0 \\ 1 \end{pmatrix} \right\}; \nu(A) = 2,$$

$$\text{Range } A = \text{span} \left\{ \begin{pmatrix} 1 \\ 0 \\ 1 \\ 2 \end{pmatrix}, \begin{pmatrix} -1 \\ 1 \\ -2 \\ -3 \end{pmatrix} \right\}, \rho(A) = 2.$$

$$33. C = \begin{pmatrix} 1 & -1 \\ 2 & 2 \end{pmatrix}; C^{-1} = \frac{1}{4} \begin{pmatrix} 2 & 1 \\ -2 & 1 \end{pmatrix}; C^{-1} \begin{pmatrix} 2 \\ -1 \end{pmatrix} = \begin{pmatrix} 3/4 \\ -5/4 \end{pmatrix}$$

$$34. C = \begin{pmatrix} 1 & 1 & 0 \\ 0 & 1 & 2 \\ 1 & 0 & 3 \end{pmatrix}; C^{-1} = \frac{1}{5} \begin{pmatrix} 3 & -3 & 2 \\ 2 & 3 & -2 \\ -2 & 2 & 2 \end{pmatrix}; C^{-1} \begin{pmatrix} -3 \\ 4 \\ 2 \end{pmatrix} = \begin{pmatrix} -17/5 \\ 2/5 \\ 18/5 \end{pmatrix}$$

$$35. C = \begin{pmatrix} 1 & 1 & 1 \\ 0 & 1 & 0 \\ 1 & 0 & 0 \end{pmatrix}; C^{-1} = \begin{pmatrix} 0 & 0 & 1 \\ 0 & 1 & 0 \\ 1 & -1 & -1 \end{pmatrix}; C^{-1} \begin{pmatrix} 4 \\ 0 \\ 1 \end{pmatrix} = \begin{pmatrix} 1 \\ 0 \\ 3 \end{pmatrix}. \text{ Then}$$

$$4 + x^2 = (1)(1 + x^2) + (0)(1 + x) + (3)(1)$$

$$36. C = \begin{pmatrix} 1 & 1 & 0 & 0 \\ 1 & -1 & 0 & 0 \\ 0 & 0 & 1 & 1 \\ 0 & 0 & 1 & -1 \end{pmatrix}; C^{-1} = \frac{1}{2} \begin{pmatrix} 1 & 1 & 0 & 0 \\ 1 & -1 & 0 & 0 \\ 0 & 0 & 1 & 1 \\ 0 & 0 & 1 & -1 \end{pmatrix}; C^{-1} \begin{pmatrix} 3 \\ 1 \\ 0 \\ 1 \end{pmatrix} = \begin{pmatrix} 2 \\ 1 \\ 1/2 \\ -1/2 \end{pmatrix}.$$

$$\text{Then } \begin{pmatrix} 3 & 1 \\ 0 & 1 \end{pmatrix} = 2 \begin{pmatrix} 1 & 1 \\ 0 & 0 \end{pmatrix} + \begin{pmatrix} 1 & -1 \\ 0 & 0 \end{pmatrix} + \frac{1}{2} \begin{pmatrix} 0 & 0 \\ 1 & 1 \end{pmatrix} - \frac{1}{2} \begin{pmatrix} 0 & 0 \\ 1 & -1 \end{pmatrix}$$

$$37. \mathbf{v}_1 = \begin{pmatrix} 2 \\ 3 \end{pmatrix}, \mathbf{v}_2 = \begin{pmatrix} -1 \\ 4 \end{pmatrix}; \|\mathbf{v}_1\| = \sqrt{4+9} = \sqrt{13}; \mathbf{u}_1 = \begin{pmatrix} 2/\sqrt{13} \\ 3/\sqrt{13} \end{pmatrix}; \mathbf{v}'_2 = \begin{pmatrix} -1 \\ 4 \end{pmatrix} - 10/\sqrt{13} \begin{pmatrix} 2/\sqrt{13} \\ 3/\sqrt{13} \end{pmatrix} = \begin{pmatrix} -33/13 \\ 22/13 \end{pmatrix}; \|\mathbf{v}'_2\| = 11/\sqrt{13}; \mathbf{u}_2 = \begin{pmatrix} -3/\sqrt{13} \\ 2/\sqrt{13} \end{pmatrix}$$

$$38. \text{Basis: } \mathbf{v}_1 = \begin{pmatrix} 1 \\ 10 \end{pmatrix}, \mathbf{v}_2 = \begin{pmatrix} 1 \\ 0 \end{pmatrix}; \|\mathbf{v}_1\| = \sqrt{2}; \mathbf{u}_1 = \begin{pmatrix} 1/\sqrt{2} \\ 1/\sqrt{2} \\ 0 \end{pmatrix}; \mathbf{v}'_2 = \begin{pmatrix} 1 \\ 0 \\ 1 \end{pmatrix} - \frac{1}{\sqrt{2}} \begin{pmatrix} 1/2 \\ -1/2 \\ 1 \end{pmatrix}; \|\mathbf{v}'_2\| = \sqrt{3/2}; \mathbf{u}_2 = \begin{pmatrix} 1/\sqrt{6} \\ -1/\sqrt{6} \\ 2/\sqrt{6} \end{pmatrix}$$

$$39. \text{Basis: } \mathbf{v}_1 = \begin{pmatrix} 1 \\ 1 \\ 1 \end{pmatrix}; \|\mathbf{v}_1\| = \sqrt{3}; \mathbf{u}_1 = \begin{pmatrix} 1/\sqrt{3} \\ 1/\sqrt{3} \\ 1/\sqrt{3} \end{pmatrix}$$

$$40. \text{Basis: } \mathbf{v}_1 = \begin{pmatrix} 1 \\ 0 \\ 1 \\ 0 \end{pmatrix}, \mathbf{v}_2 = \begin{pmatrix} 0 \\ 1 \\ 0 \\ 1 \end{pmatrix}; \|\mathbf{v}_1\| = \sqrt{2}; \mathbf{u}_1 = \begin{pmatrix} 1/\sqrt{2} \\ 0 \\ 1/\sqrt{2} \\ 0 \end{pmatrix}; \mathbf{v}'_2 = \begin{pmatrix} 0 \\ 1 \\ 0 \\ 1 \end{pmatrix} - 0 \begin{pmatrix} 1/\sqrt{2} \\ 0 \\ 1/\sqrt{2} \\ 0 \end{pmatrix} = \begin{pmatrix} 0 \\ 1 \\ 0 \\ 1 \end{pmatrix};$$

$$\|\mathbf{v}'_2\| = \sqrt{2}; \mathbf{u}_2 = \begin{pmatrix} 0 \\ 1/\sqrt{2} \\ 0 \\ 1/\sqrt{2} \end{pmatrix}$$

$$41. (a) \text{proj}_H \mathbf{v} = \frac{1}{\sqrt{2}} \begin{pmatrix} 1/\sqrt{2} \\ 1/\sqrt{2} \\ 0 \end{pmatrix} + \frac{1}{\sqrt{6}} \begin{pmatrix} 1/\sqrt{6} \\ -1/\sqrt{6} \\ 2/\sqrt{6} \end{pmatrix} = \begin{pmatrix} 4/3 \\ -1/3 \\ 5/3 \end{pmatrix}$$

$$(b) \frac{1}{\sqrt{3}} \begin{pmatrix} 1 \\ -1 \\ -1 \end{pmatrix}$$

$$(c) \mathbf{p} = \begin{pmatrix} -1 \\ 2 \\ 4 \end{pmatrix} - \begin{pmatrix} 4/3 \\ -1/3 \\ 5/3 \end{pmatrix} = \begin{pmatrix} -7/3 \\ 7/3 \\ 7/3 \end{pmatrix}; \text{ then } \begin{pmatrix} -1 \\ 2 \\ 4 \end{pmatrix} = \begin{pmatrix} 4/3 \\ -1/3 \\ 5/3 \end{pmatrix} + \begin{pmatrix} -7/3 \\ 7/3 \\ 7/3 \end{pmatrix}$$

$$42. (a) \text{proj}_H \mathbf{v} = \begin{pmatrix} 0 \\ 0 \\ 0 \end{pmatrix}$$

$$(b) \frac{1}{\sqrt{2}} \begin{pmatrix} -1 \\ 1 \\ 0 \end{pmatrix}, \frac{1}{\sqrt{2}} \begin{pmatrix} -1 \\ 0 \\ 1 \end{pmatrix}$$

$$(c) \begin{pmatrix} 1 \\ 0 \\ -1 \end{pmatrix} = \begin{pmatrix} 1 \\ -0 \\ -1 \end{pmatrix} + \begin{pmatrix} 0 \\ 0 \\ 0 \end{pmatrix}$$

$$43. (a) \text{proj}_H \mathbf{v} = \frac{1}{\sqrt{2}} \begin{pmatrix} 1/\sqrt{2} \\ 0 \\ 1/\sqrt{2} \\ 0 \end{pmatrix} + \frac{1}{\sqrt{2}} \begin{pmatrix} 0 \\ 1/\sqrt{2} \\ 0 \\ 1/\sqrt{2} \end{pmatrix} = \begin{pmatrix} 1/2 \\ 1/2 \\ 1/2 \\ 1/2 \end{pmatrix}$$

$$(b) \begin{pmatrix} 1/\sqrt{2} \\ 0 \\ -1/\sqrt{2} \\ 0 \end{pmatrix}, \begin{pmatrix} 0 \\ 1/\sqrt{2} \\ 0 \\ -1/\sqrt{2} \end{pmatrix}$$

$$(c) \mathbf{p} = \begin{pmatrix} 1 \\ 0 \\ 0 \\ 1 \end{pmatrix} - \begin{pmatrix} 1/2 \\ 1/2 \\ 1/2 \\ 1/2 \end{pmatrix} = \begin{pmatrix} 1/2 \\ -1/2 \\ -1/2 \\ 1/2 \end{pmatrix}; \text{ then } \begin{pmatrix} 1 \\ 0 \\ 0 \\ 1 \end{pmatrix} = \begin{pmatrix} 1/2 \\ 1/2 \\ 1/2 \\ 1/2 \end{pmatrix} + \begin{pmatrix} 1/2 \\ -1/2 \\ -1/2 \\ 1/2 \end{pmatrix}$$

$$44. \text{ Start with the basis } \{1, x, x^2\}. \int_0^2 1^2 dx = 2. \text{ Let } \mathbf{u}_1 = 1/\sqrt{2}. (\mathbf{v}_2, \mathbf{u}_1) = \int_0^2 (x/\sqrt{2}) dx = 2/\sqrt{2}.$$

$$\mathbf{v}'_2 = x - 1. \|\mathbf{v}'_2\| = \left[\int_0^2 (x-1)^2 dx \right]^{1/2} = \sqrt{2/3}. \mathbf{u}_2 = \sqrt{3/2}(x-1). (\mathbf{v}_3, \mathbf{u}_1) = \int_0^2 (x^2/\sqrt{2}) dx =$$

$$8/3\sqrt{2}. (\mathbf{v}_3, \mathbf{u}_2) = \sqrt{3/2} \int_0^2 (x^3 - x^2) dx = 4/\sqrt{6}. \mathbf{v}'_3 = x^2 - (2x - 2) - 8/3 = x^2 - 2x - 2/3.$$

$$\|\mathbf{v}'_3\| = \left[\int_0^2 (x^2 - 2x - 2/3)^2 dx \right]^{1/2} = 2\sqrt{14/15}.$$

$$\text{Orthonormal basis: } \{1/\sqrt{2}, \sqrt{3/2}(x-1), \sqrt{15/2}\sqrt{14}(x^2 - 2x - 2/3)\}.$$

45.

$$\begin{aligned} \text{proj}_{P_2[0,2]} e^x &= (e^x, \mathbf{u}_1)\mathbf{u}_1 + (e^x, \mathbf{u}_2)\mathbf{u}_2 + (e^x, \mathbf{u}_3)\mathbf{u}_3 \\ &= (e^2 - 1)/2 + 3(2)(x-1)/2 + 15(-2e^2/3 - 10/3)(x^2 - 2x - 2/3)/56 \\ &= (-5e^2/28 - 25/28)x^2 + (5e^2/14 + 67/14)x + (13e^2/21 - 61/21) \end{aligned}$$

$$46. A = \begin{pmatrix} 1 & 2 \\ 1 & -1 \\ 1 & 1 \end{pmatrix}, \mathbf{y} = \begin{pmatrix} 5 \\ -3 \\ 0 \end{pmatrix}; A^t A = \begin{pmatrix} 3 & 2 \\ 2 & 6 \end{pmatrix}, (A^t A)^{-1} = \frac{1}{14} \begin{pmatrix} 6 & -2 \\ -2 & 3 \end{pmatrix};$$

$$\mathbf{u} = \frac{1}{14} \begin{pmatrix} 6 & -2 \\ -2 & 3 \end{pmatrix} \begin{pmatrix} 1 & 1 & 1 \\ 2 & -1 & 1 \end{pmatrix} \begin{pmatrix} 5 \\ -3 \\ 0 \end{pmatrix} = \begin{pmatrix} -1 \\ 5/2 \end{pmatrix}; y = 5x/2 - 1.$$

$$47. A = \begin{pmatrix} 1 & 2 & 4 \\ 1 & -1 & 1 \\ 1 & 1 & 1 \end{pmatrix}, \mathbf{y} = \begin{pmatrix} 5 \\ -3 \\ 0 \end{pmatrix}; A^t A = \begin{pmatrix} 3 & 2 & 6 \\ 2 & 6 & 8 \\ 6 & 8 & 18 \end{pmatrix}, (A^t A)^{-1} = \frac{1}{18} \begin{pmatrix} 22 & 6 & -10 \\ 6 & 9 & -6 \\ -10 & -6 & 7 \end{pmatrix};$$

$$\mathbf{u} = \frac{1}{18} \begin{pmatrix} 22 & 6 & -10 \\ 6 & 9 & -6 \\ -10 & -6 & 7 \end{pmatrix} \begin{pmatrix} 1 & 1 & 1 \\ 2 & -1 & 1 \\ 4 & 1 & 1 \end{pmatrix} \begin{pmatrix} 5 \\ -3 \\ 0 \end{pmatrix} = \frac{1}{6} \begin{pmatrix} -16 \\ 9 \\ 7 \end{pmatrix}; y = (-16 + 9x + 7x^2)/6$$

Chapter 5. Linear Transformations

Section 5.1

$$1. \text{ linear; } T(\mathbf{x}_1 + \mathbf{x}_2) = T \begin{pmatrix} x_1 + x_2 \\ y_1 + y_2 \end{pmatrix} = \begin{pmatrix} x_1 + x_2 \\ 0 \end{pmatrix} = \begin{pmatrix} x_1 \\ 0 \end{pmatrix} + \begin{pmatrix} x_2 \\ 0 \end{pmatrix} = T\mathbf{x}_1 + T\mathbf{x}_2; T(\alpha\mathbf{x}) = \begin{pmatrix} \alpha x \\ 0 \end{pmatrix} = \alpha \begin{pmatrix} x \\ 0 \end{pmatrix} = \alpha T\mathbf{x}$$

$$2. \text{ not linear; } T(\mathbf{x}_1 + \mathbf{x}_2) = \begin{pmatrix} 1 \\ y_1 + y_2 \end{pmatrix} \neq \begin{pmatrix} 1 \\ y_1 \end{pmatrix} + \begin{pmatrix} 1 \\ y_2 \end{pmatrix} = T\mathbf{x}_1 + T\mathbf{x}_2$$

$$3. \text{ linear; } T(\mathbf{x}_1 + \mathbf{x}_2) = T \begin{pmatrix} x_1 + x_2 \\ y_1 + y_2 \\ z_1 + z_2 \end{pmatrix} = \begin{pmatrix} x_1 + x_2 \\ y_1 + y_2 \end{pmatrix} = \begin{pmatrix} x_1 \\ y_1 \end{pmatrix} + \begin{pmatrix} x_2 \\ y_2 \end{pmatrix} = T\mathbf{x}_1 + T\mathbf{x}_2; T(\alpha\mathbf{x}) = \begin{pmatrix} \alpha x \\ \alpha y \end{pmatrix} = \alpha \begin{pmatrix} x \\ y \end{pmatrix} = \alpha T\mathbf{x}$$

$$4. \text{ linear; } T(\mathbf{x}_1 + \mathbf{x}_2) = T \begin{pmatrix} x_1 + x_2 \\ y_1 + y_2 \\ z_1 + z_2 \end{pmatrix} = \begin{pmatrix} 0 \\ y_1 + y_2 \end{pmatrix} = \begin{pmatrix} 0 \\ y_1 \end{pmatrix} + \begin{pmatrix} 0 \\ y_2 \end{pmatrix} = T\mathbf{x}_1 + T\mathbf{x}_2; T(\alpha\mathbf{x}) = \begin{pmatrix} 0 \\ \alpha y \end{pmatrix} = \alpha \begin{pmatrix} 0 \\ y \end{pmatrix} = \alpha T\mathbf{x}$$

$$5. \text{ not linear; } T(\mathbf{x}_1 + \mathbf{x}_2) = T \begin{pmatrix} x_1 + x_2 \\ y_1 + y_2 \\ z_1 + z_2 \end{pmatrix} = \begin{pmatrix} 1 \\ z_1 + z_2 \end{pmatrix} \neq \begin{pmatrix} 1 \\ z_1 \end{pmatrix} + \begin{pmatrix} 1 \\ z_2 \end{pmatrix} = T\mathbf{x}_1 + T\mathbf{x}_2$$

$$6. \text{ not linear; if } \alpha \neq 0 \text{ or } 1 \text{ and } x \neq 0 \neq y, \text{ then } T(\alpha\mathbf{x}) = T \begin{pmatrix} \alpha x \\ \alpha y \end{pmatrix} = \begin{pmatrix} \alpha^2 x^2 \\ \alpha^2 y^2 \end{pmatrix} = \alpha^2 \begin{pmatrix} x^2 \\ y^2 \end{pmatrix} \neq \alpha \begin{pmatrix} x^2 \\ y^2 \end{pmatrix} = \alpha T\mathbf{x}$$

$$7. \text{ linear; } T(\mathbf{x}_1 + \mathbf{x}_2) = T \begin{pmatrix} x_1 + x_2 \\ y_1 + y_2 \end{pmatrix} = \begin{pmatrix} y_1 + y_2 \\ x_1 + x_2 \end{pmatrix} = \begin{pmatrix} y_1 \\ x_1 \end{pmatrix} + \begin{pmatrix} y_2 \\ x_2 \end{pmatrix} = T\mathbf{x}_1 + T\mathbf{x}_2; T(\alpha\mathbf{x}) = \begin{pmatrix} \alpha y \\ \alpha x \end{pmatrix} = \alpha \begin{pmatrix} y \\ x \end{pmatrix} = \alpha T\mathbf{x}$$

$$8. \text{ linear; } T(\mathbf{x}_1 + \mathbf{x}_2) = \begin{pmatrix} (x_1 + x_2) + (y_1 + y_2) \\ (x_1 + x_2) - (y_1 + y_2) \end{pmatrix} = \begin{pmatrix} x_1 + y_1 \\ x_1 - y_1 \end{pmatrix} + \begin{pmatrix} x_2 + y_2 \\ x_2 - y_2 \end{pmatrix} = T\mathbf{x}_1 + T\mathbf{x}_2; T(\alpha\mathbf{x}) = \begin{pmatrix} \alpha x + \alpha y \\ \alpha x - \alpha y \end{pmatrix} = \alpha \begin{pmatrix} x + y \\ x - y \end{pmatrix} = \alpha T\mathbf{x}$$

$$9. \text{ not linear; if } \alpha \neq 0 \text{ or } 1, \text{ then } T(\alpha\mathbf{x}) = T \begin{pmatrix} \alpha x \\ \alpha y \end{pmatrix} = (\alpha x)(\alpha y) = \alpha^2 xy \neq \alpha xy = \alpha T\mathbf{x}$$

$$10. \text{ linear; } T(\mathbf{x} + \mathbf{y}) = \begin{pmatrix} x_1 + y_1 \\ x_2 + y_2 \\ \vdots \\ x_n + y_n \end{pmatrix} = \sum_{i=1}^n (x_i + y_i) = \sum_{i=1}^n x_i + \sum_{i=1}^n y_i = T\mathbf{x} + T\mathbf{y}; T(\alpha\mathbf{x}) = T \begin{pmatrix} \alpha x_1 \\ \alpha x_2 \\ \vdots \\ \alpha x_n \end{pmatrix} = \sum_{i=1}^n \alpha x_i = \alpha \sum_{i=1}^n x_i = \alpha T\mathbf{x}$$

$$11. \text{ linear; } T(x+y) = \begin{pmatrix} x+y \\ x+y \\ \vdots \\ x+y \end{pmatrix} = \begin{pmatrix} x \\ x \\ \vdots \\ x \end{pmatrix} + \begin{pmatrix} y \\ y \\ \vdots \\ y \end{pmatrix} = T(x) + T(y); T(\alpha x) = \begin{pmatrix} \alpha x \\ \alpha x \\ \vdots \\ \alpha x \end{pmatrix} = \alpha \begin{pmatrix} x \\ x \\ \vdots \\ x \end{pmatrix} = \alpha T(x)$$

$$12. \text{ linear; } T(\mathbf{x}_1 + \mathbf{x}_2) = T \begin{pmatrix} x_1 + x_2 \\ y_1 + y_2 \\ w_1 + w_2 \\ z_1 + z_2 \end{pmatrix} = \begin{pmatrix} (x_1 + x_2) + (z_1 + z_2) \\ (y_1 + y_2) + (w_1 + w_2) \end{pmatrix} \begin{pmatrix} x_1 + z_1 \\ y_1 + w_1 \end{pmatrix} + \begin{pmatrix} x_2 + z_2 \\ y_2 + w_2 \end{pmatrix} = T\mathbf{x}_1 + T\mathbf{x}_2; T(\alpha \mathbf{x}) = \begin{pmatrix} \alpha x + \alpha z \\ \alpha y + \alpha w \end{pmatrix} = \alpha \begin{pmatrix} x + z \\ y + w \end{pmatrix} = \alpha T\mathbf{x}$$

$$13. \text{ not linear; if } \alpha \neq 0 \text{ or } 1, xyzw \neq 0 \text{ then } T(\alpha \mathbf{x}) = \begin{pmatrix} (\alpha x) & (\alpha z) \\ (\alpha y) & (\alpha w) \end{pmatrix} = \alpha^2 \begin{pmatrix} xz \\ yw \end{pmatrix} \neq \alpha \begin{pmatrix} xz \\ yw \end{pmatrix} = \alpha T\mathbf{x}$$

$$14. \text{ linear; } T(A + A') = (A + A')B = AB + A'B = T(A) + T(A'); T(\alpha A) = (\alpha A)B = \alpha(AB) = \alpha T(A)$$

$$15. \text{ not linear; } T(A+B) = (A+B)^t(A+B) = (A^t + B^t)(A+B) = A^tA + A^tB + B^tA + B^tB \neq A^tA + B^tB = T(A) + T(B) \text{ unless } A^tB + B^tA = 0$$

16. linear; same solution as problem 14

$$17. \text{ not linear; if } \alpha \neq 0 \text{ or } 1, D \neq O \text{ then } T(\alpha D) = \alpha^2 D^2 \neq \alpha D^2 = \alpha T(D)$$

$$18. \text{ not linear; } T(\alpha D) = I + \alpha D \neq \alpha(I + D) = \alpha T(D) \text{ unless } \alpha = 1$$

$$19. \text{ linear; } T[(a_0 + a_1x + a_2x^2) + (b_0 + b_1x + b_2x^2)] = (a_0 + b_0) + (a_1 + b_1)x = a_0 + a_1x + b_0 + b_1x = T(a_0 + a_1x + a_2x^2) + T(b_0 + b_1x + b_2x^2); T[\alpha(a_0 + a_1x + a_2x^2)] = \alpha a_0 + \alpha a_1x = \alpha(a_0 + a_1x) = \alpha T(a_0 + a_1x + a_2x^2)$$

$$20. \text{ linear; } T[(a_0 + a_1x + a_2x^2) + (b_0 + b_1x + b_2x^2)] = (a_1 + b_1) + (a_2 + b_2)x = a_1 + a_2x + b_1 + b_2x = T(a_0 + a_1x + a_2x^2) + T(b_0 + b_1x + b_2x^2); T[\alpha(a_0 + a_1x + a_2x^2)] = \alpha a_1 + \alpha a_2x = \alpha(a_1 + a_2x) = \alpha T(a_0 + a_1x + a_2x^2)$$

$$21. \text{ linear; } T(a+b) = (a+b) + (a+b)x + (a+b)x^2 + \cdots + (a+b)x^n = a + ax + ax^2 + \cdots + ax^n + b + bx + bx^2 + \cdots + bx^n = T(a) + T(b); T(\alpha a) = \alpha a + \alpha ax + \alpha ax^2 + \cdots + \alpha ax^n = \alpha(a + ax + ax^2 + \cdots + ax^n) = \alpha T(a)$$

$$22. \text{ not linear; } T(\alpha p(x)) = \alpha^2 [p(x)]^2 \neq \alpha [p(x)]^2 = \alpha T(p(x)) \text{ unless } \alpha = 0 \text{ or } 1, \text{ or } p = 0.$$

$$23. \text{ not linear; if } \alpha \neq 0 \text{ or } 1 \text{ then } T(\alpha f) = \alpha^2 f^2(x) \neq \alpha f^2(x) = \alpha T f$$

$$24. \text{ not linear; } T(\alpha f) = \alpha f(x) + 1 \neq \alpha(f(x) + 1) = \alpha T f \text{ unless } \alpha = 1$$

$$25. \text{ linear; } T(f_1 + f_2) = \int_0^1 (f_1(x) + f_2(x))g(x) dx = \int_0^1 f_1(x)g(x) dx + \int_0^1 f_2(x)g(x) dx = T f_1 + T f_2;$$

$$T(\alpha f) = \int_0^1 \alpha f(x)g(x) dx = \alpha \int_0^1 f(x)g(x) dx = \alpha T f$$

$$26. \text{ linear; } T(f_1 + f_2) = [(f_1 + f_2)g]' = (f_1 + f_2)'g + (f_1 + f_2)g' = f_1'g + f_2'g + f_1g' + f_2g' + (f_2g)' = T f_1 + T f_2; T(\alpha f) = [(\alpha f)g]' = \alpha(fg)' = \alpha T f$$

$$27. \text{ linear; } T(f(x) + g(x)) = f(x-1) + g(x-1) = T f(x) + T g(x); T(\alpha f(x)) = \alpha f(x-1) = \alpha T f(x)$$

$$28. \text{ linear; } T(f + g) = f(1/2) + g(1/2) = T f + T g; T(\alpha f) = \alpha f(1/2) = \alpha T f$$

$$29. \text{ not linear; if } \alpha \neq 0 \text{ or } 1, \text{ and } \det(A) \neq 0, \text{ then } T(\alpha A) = \det(\alpha A) = \alpha^n \det A \neq \alpha \det A = \alpha T(A)$$

30. Geometrically, T rotates a vector in the xy -plane through an angle of 180 degrees, or, equivalently, T reflects a vector through the origin.

$$31. (a) T \begin{pmatrix} 2 \\ 4 \end{pmatrix} = 2 \left[T \begin{pmatrix} 1 \\ 0 \end{pmatrix} + 2T \begin{pmatrix} 0 \\ 1 \end{pmatrix} \right] = 2 \left[\begin{pmatrix} 1 \\ 2 \\ 3 \end{pmatrix} + 2 \begin{pmatrix} -4 \\ 0 \\ 5 \end{pmatrix} \right] = \begin{pmatrix} -14 \\ 4 \\ 26 \end{pmatrix}$$

$$(b) T \begin{pmatrix} -3 \\ 7 \end{pmatrix} = -3T \begin{pmatrix} 1 \\ 0 \end{pmatrix} + 7T \begin{pmatrix} 0 \\ 1 \end{pmatrix} = -3 \begin{pmatrix} 1 \\ 2 \\ 3 \end{pmatrix} + 7T \begin{pmatrix} -4 \\ 0 \\ 5 \end{pmatrix} = \begin{pmatrix} -31 \\ -6 \\ 26 \end{pmatrix}$$

$$32. (a) A_\theta = \begin{pmatrix} \sqrt{3}/2 & -1/2 \\ 1/2 & \sqrt{3}/2 \end{pmatrix} \quad (b) A_\theta \begin{pmatrix} -3 \\ 4 \end{pmatrix} = \begin{pmatrix} -(4 + 3\sqrt{3})/2 \\ (-3 + 4\sqrt{3})/2 \end{pmatrix}$$

33. T rotates a vector counterclockwise around the z -axis through an angle θ in a plane parallel to the xy -plane.

34. T rotates a vector counterclockwise around the y -axis through an angle θ in a plane parallel to the xz -plane.

35. Suppose $\alpha < 0$. We have $T[(\alpha - \alpha)\mathbf{x}] = T(0\mathbf{x}) = 0T\mathbf{x} = \mathbf{0}$, so that $\mathbf{0} = T(\alpha\mathbf{x} - \alpha\mathbf{x}) = T(\alpha\mathbf{x}) + T(-\alpha\mathbf{x}) = T(\alpha\mathbf{x}) - \alpha T\mathbf{x}$. Thus, $T(\alpha\mathbf{x}) = \alpha T\mathbf{x}$ if $\alpha < 0$.

36. Define $T(A) = T \begin{pmatrix} a_{11} & a_{12} & a_{13} \\ a_{21} & a_{22} & a_{23} \\ a_{31} & a_{32} & a_{33} \end{pmatrix} = \begin{pmatrix} a_{11} & a_{12} \\ a_{21} & a_{22} \end{pmatrix}$. Since $T(A + B) = \begin{pmatrix} a_{11} + b_{11} & a_{12} + b_{12} \\ a_{21} + b_{21} & a_{22} + b_{22} \end{pmatrix} = \begin{pmatrix} a_{11} & a_{12} \\ a_{21} & a_{22} \end{pmatrix} + \begin{pmatrix} b_{11} & b_{12} \\ b_{21} & b_{22} \end{pmatrix} = T(A) + T(B)$, and $T(\alpha A) = \begin{pmatrix} \alpha a_{11} & \alpha a_{12} \\ \alpha a_{21} & \alpha a_{22} \end{pmatrix} = \alpha \begin{pmatrix} a_{11} & a_{12} \\ a_{21} & a_{22} \end{pmatrix} = \alpha T(A)$, then T is linear. Many other examples possible.

$$37. T(\mathbf{x} - \mathbf{y}) = T(\mathbf{x} + (-\mathbf{y})) = T\mathbf{x} + T((-1)\mathbf{y}) = T\mathbf{x} + (-1)T\mathbf{y} = T\mathbf{x} - T\mathbf{y}$$

38. $T\mathbf{0} = T(\mathbf{x} - \mathbf{x}) = T\mathbf{x} - T\mathbf{x} = \mathbf{0}$; if V and W are different, then the two zero vectors may be different

$$39. T(\mathbf{v}_1 + \mathbf{v}_2) = (\mathbf{v}_1 + \mathbf{v}_2, \mathbf{u}_0) = (\mathbf{v}_1, \mathbf{u}_0) + (\mathbf{v}_2, \mathbf{u}_0) = T\mathbf{v}_1 + T\mathbf{v}_2; T(\alpha\mathbf{v}) = (\alpha\mathbf{v}, \mathbf{u}_0) = \alpha(\mathbf{v}, \mathbf{u}_0) = \alpha T\mathbf{v}$$

$$40. T(\alpha\mathbf{v}) = (\mathbf{u}_0, \alpha\mathbf{v}) = \bar{\alpha}(\mathbf{u}_0, \mathbf{v}) \neq \alpha(\mathbf{u}_0, \mathbf{v}) = \alpha T\mathbf{v} \text{ unless } \alpha \text{ is real.}$$

41.

$$\begin{aligned} T(\mathbf{v}_1 + \mathbf{v}_2) &= (\mathbf{v}_1 + \mathbf{v}_2, \mathbf{u}_1)\mathbf{u}_1 + (\mathbf{v}_1 + \mathbf{v}_2, \mathbf{u}_2)\mathbf{u}_2 + \cdots + (\mathbf{v}_1 + \mathbf{v}_2, \mathbf{u}_k)\mathbf{u}_k \\ &= (\mathbf{v}_1, \mathbf{u}_1)\mathbf{u}_1 + (\mathbf{v}_1, \mathbf{u}_2)\mathbf{u}_2 + \cdots + (\mathbf{v}_1, \mathbf{u}_k)\mathbf{u}_k + (\mathbf{v}_2, \mathbf{u}_1)\mathbf{u}_1 + (\mathbf{v}_2, \mathbf{u}_2)\mathbf{u}_2 + \cdots + (\mathbf{v}_2, \mathbf{u}_k)\mathbf{u}_k \\ &= T\mathbf{v}_1 + T\mathbf{v}_2; \end{aligned}$$

$$\begin{aligned} T(\alpha\mathbf{v}) &= (\alpha\mathbf{v}, \mathbf{u}_1)\mathbf{u}_1 + (\alpha\mathbf{v}, \mathbf{u}_2)\mathbf{u}_2 + \cdots + (\alpha\mathbf{v}, \mathbf{u}_k)\mathbf{u}_k \\ &= \alpha[(\mathbf{v}, \mathbf{u}_1)\mathbf{u}_1 + (\mathbf{v}, \mathbf{u}_2)\mathbf{u}_2 + \cdots + (\mathbf{v}, \mathbf{u}_k)\mathbf{u}_k] = \alpha T\mathbf{v} \end{aligned}$$

42. Let $T_1 \in L(V, W)$ and $T_2 \in L(V, W)$. As $(T_1 + T_2)(\mathbf{x} + \mathbf{y}) = T_1(\mathbf{x} + \mathbf{y}) + T_2(\mathbf{x} + \mathbf{y}) = T_1\mathbf{x} + T_2\mathbf{x} + T_1\mathbf{y} + T_2\mathbf{y} = (T_1 + T_2)\mathbf{x} + (T_1 + T_2)\mathbf{y}$, and $(T_1 + T_2)(\alpha\mathbf{x}) = T_1(\alpha\mathbf{x}) + T_2(\alpha\mathbf{x}) = \alpha(T_1\mathbf{x} + T_2\mathbf{x}) = \alpha(T_1 + T_2)\mathbf{x}$, then we have closure under addition. Since $(\alpha T)(\mathbf{x} + \mathbf{y}) = \alpha T(\mathbf{x} + \mathbf{y}) = \alpha(T\mathbf{x} + T\mathbf{y}) = \alpha T\mathbf{x} + \alpha T\mathbf{y} = (\alpha T)\mathbf{x} + (\alpha T)\mathbf{y}$, and $(\alpha T)(\beta\mathbf{x}) = \alpha T(\beta\mathbf{x}) = \alpha\beta T\mathbf{x} = \beta\alpha T\mathbf{x} = \beta(\alpha T)\mathbf{x}$, then we have closure under scalar multiplication. Note that the zero vector is the zero transformation, and for each $T \in L(V, W)$ then $(-T) \in L(V, W)$ and $T + (-T) = 0$. The rest of the axioms follow from the usual rules of addition and scalar multiplication of functions.

MATLAB 5.1

In order to make the plots produced by 'graphics.m' show distinctions when printed or viewed on black and white media, a new sixth argument for line type, *lt*, was added to graphics.m. In addition one line in the text of graphics.m was changed: `sl=['- clr]` became `sl=[lt clr]`. Do 'help plot' in MATLAB to see the possible values for *lt*. (Also some early versions of graphics.m had a 'clg, hold off' or 'clf reset' command at the start of graphics.m which was deleted to make the overplotting approach of this problem set work.)

1. (a)

```
>> pts = [ 0 3 3 8 8 11 11 15 15 11 8 8 0 10;...
>>         0 0 3 3 0 0 7 7 10 10 12 7 7 9];
>> lns = [ 1:13 ; [ 2:13 1 ] ];
>> graphics(pts,lns,'r','*',20,':') % We'll always plot the original with dotted
>> print -deps fig511.eps           % lines so transformed figure will stand out.
```

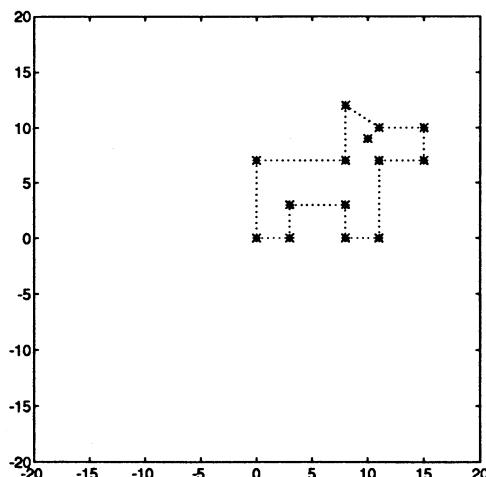

The figure is a dog without a tail. The points are red *'s and we have $-20 \leq x, y \leq 20$. The (new) ':' argument makes the line type dotted.

(b) Plot your own figure as in (a). Note that not all points need to be the ends of lines. In (a) the dog's eye is an isolated point - one which never occurs in the matrix of lines.

2. (a) If $z = x - y$, then $z + y = (x - y) + y = x$. Since $z = x - y$ and y form sides of a parallelogram

with vertices at $0, z, P_1, P_2$, the opposite sides z and $\overrightarrow{P_2P_1}$ are parallel.

The line segment from P_2 to P_1 goes from the endpoint of y in the direction represented by $x - y$ to the end point of x , and consists of the endpoints of $y + a(x - y)$, $0 \leq a \leq 1$. These points are transformed, by the linearity of T , into $Ty + aT(x - y) = Ty + a(Tx - Ty)$, $0 \leq a \leq 1$, which are exactly the points along the line segment going from the transform of P_2 (the endpoint of Ty) in the direction of $Tx - Ty$ to the transform of P_1 (the endpoint of Tx).

(b) Rotate the figure in Problem 1 by $\pi/2$ radians clockwise:

```
>> th = -pi/2; A = [cos(th) -sin(th); sin(th) cos(th)] ;
>> graphics(pts,lns,'r','*',20,':')
>> hold on
>> graphics(A*pts,lns,'b','*',20,'--') % Dashed blue lines for transformed figure
>> hold off
>> print -deps fig512b.eps
```

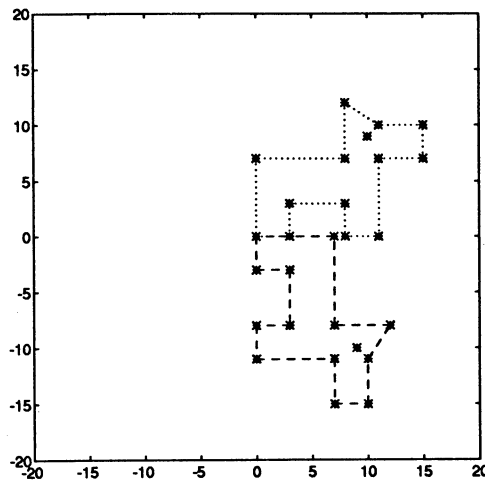
(c) Rotation by $2\pi/3$ counterclockwise:

```
>> th = 2*pi/3; A = [cos(th) -sin(th); sin(th) cos(th)] ;
>> grafics(pts,lns,'c1','*',20,':')      % Dotted lines
>> hold on
>> grafics(A*pts,lns,'c2','*',20,'--')
>> hold off
>> print -deps fig512c.eps
```

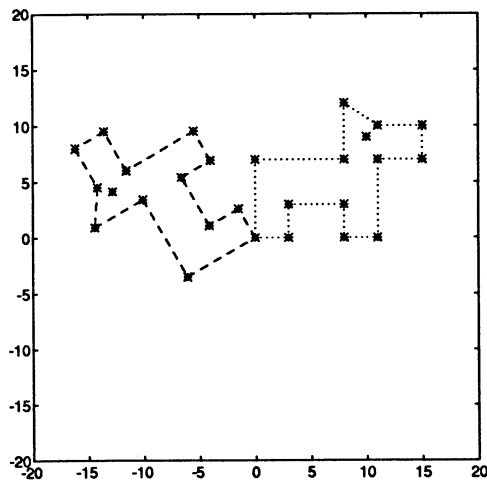

(d) Rotate your figure from Problem 1(b) by some angle.

3. (a) If you look at the entries in `pnts` you see that the maximum value, in either direction, is 15. Thus $M = 32$ is large enough for this problem, since all coordinates will be stretched by a factor of 2.

```
>> A = 2*eye(2);
>> grafics(pts,lns,'r','*',32,':')
>> hold on
>> grafics(A*pts,lns,'b','+',32,'--') % Use + for points on transformed figure
>> hold off
>> print -deps fig513a.eps
```

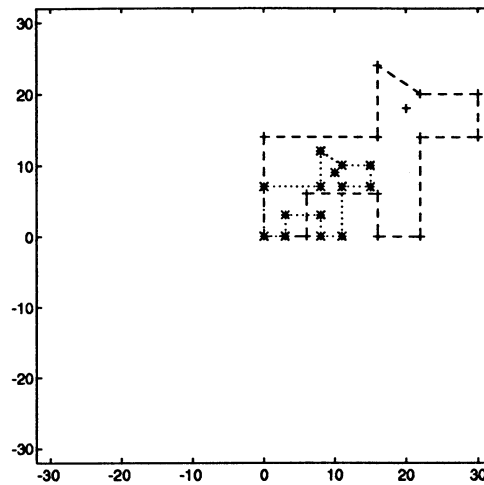

(b)

```

>> A = [2 0 ; 0 1]; % This stretches x-coordinates by factor of 2
>> graphics(pts,lns,'r','*',32,':')
>> hold on
>> graphics(A*pts,lns,'b','+',32,'--')
>> hold off
>> print -deps fig513bi.eps

```

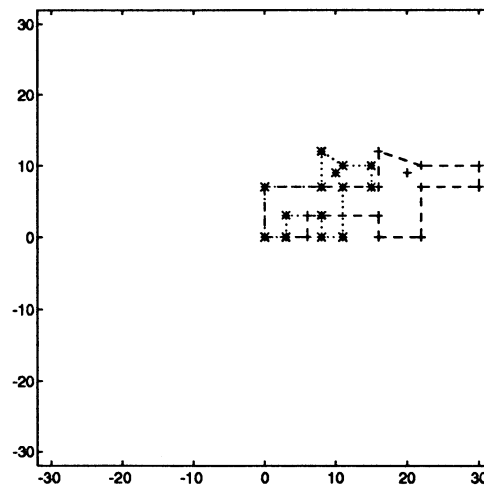

```

>> A = [1 0 ; 0 2]; % This stretches y-coordinates by factor of 2
>> graphics(pts,lns,'r','*',32,':')
>> hold on
>> graphics(A*pts,lns,'b','*',32,'--')
>> hold off
>> print -deps fig513bii.eps

```

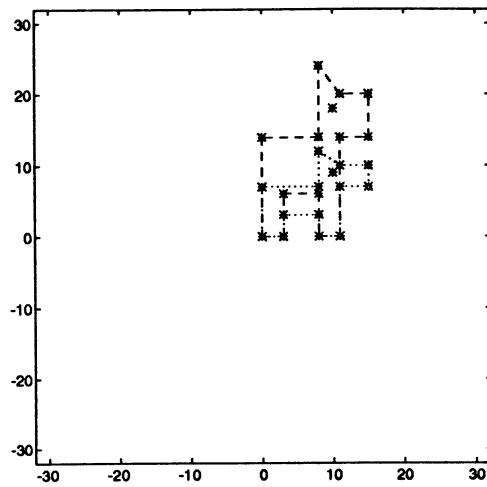

- (c) Multiplication by $A = \begin{pmatrix} r & 0 \\ 0 & s \end{pmatrix}$ scales the x -coordinates by a factor of r and the y -coordinates by a factor of s .

Section 5.2

1. $\text{Ker } T = \{(x, y) : x = 0\}$; $\nu(T) = 1$; $\text{Range } T = \{(x, y) : y = 0\}$; $\rho(T) = 1$.
2. $\text{Ker } T = \{(x, y, z) : y = 0 \text{ and } z = 0\}$; $\nu(T) = 1$; $\text{Range } T = \mathbb{R}^2$; $\rho(T) = 2$.
3. $\text{Ker } T = \{(x, y) : x = -y\}$; $\nu(T) = 1$; $\text{Range } T = \mathbb{R}$; $\rho(T) = 1$.
4. $\text{Ker } T = \{(x, y, z, w) : x = -z \text{ and } y = -w\}$; $\nu(T) = 2$; $\text{Range } T = \mathbb{R}^2$; $\rho(T) = 2$
5. Let $A = \begin{pmatrix} x & y \\ z & w \end{pmatrix}$. Then $AB = \begin{pmatrix} x & 2x + y \\ z & 2z + w \end{pmatrix}$. $\text{Ker } T = \left\{ \begin{pmatrix} 0 & 0 \\ 0 & 0 \end{pmatrix} \right\}$; $\nu(T) = 0$; $\text{Range } T = M_{22}$; $\rho(T) = 4$.
6. $\text{Ker } T = \{0\}$; $\nu(T) = 0$; $\text{Range } T = \{a + ax + ax^2 + ax^3 : a \in \mathbb{R}\}$; $\rho(T) = 1$.
7. $\text{Ker } T = \{A : A^t = -A\}$; $\nu(T) = (n^2 - n)/2$; $\text{Range } T = \{A : A \text{ is symmetric}\}$; $\rho(T) = (n^2 + n)/2$.
8. $\text{Ker } T = \{f \in C[0, 1] : f = \text{constant}\}$; $\nu(T) = 1$; $\text{Range } T = \{f \in C[0, 1]\}$ by fundamental theorem of calculus; $\text{Range } T$ is infinite dimensional.
9. $\text{Ker } T = \{f \in C[0, 1] : f(1/2) = 0\}$; $\text{Ker } T$ is infinite dimensional; $\text{Range } T = \mathbb{R}$; $\rho(T) = 1$.
10. $\text{Ker } T = \{(0, 0)\}$; $\nu(T) = 0$; $\text{Range } T = \mathbb{R}^2$; $\rho(T) = 2$.
11. For any $\mathbf{v} \in V$, $\mathbf{v} = a_1\mathbf{v}_1 + a_2\mathbf{v}_2 + \cdots + a_n\mathbf{v}_n$ for some (a_1, a_2, \dots, a_n) . Then

$$\begin{aligned} T\mathbf{v} &= T(a_1\mathbf{v}_1 + a_2\mathbf{v}_2 + \cdots + a_n\mathbf{v}_n) \\ &= a_1T\mathbf{v}_1 + a_2T\mathbf{v}_2 + \cdots + a_nT\mathbf{v}_n \\ &= a_1 \cdot \mathbf{0} + a_2 \cdot \mathbf{0} + \cdots + a_n \cdot \mathbf{0} = \mathbf{0}. \end{aligned}$$

Thus T is the zero transformation.

12. For any $\mathbf{v} \in V$, $\mathbf{v} = a_1\mathbf{v}_1 + a_2\mathbf{v}_2 + \cdots + a_n\mathbf{v}_n$ for some (a_1, a_2, \dots, a_n) . Then

$$\begin{aligned} T\mathbf{v} &= T(a_1\mathbf{v}_1 + a_2\mathbf{v}_2 + \cdots + a_n\mathbf{v}_n) \\ &= a_1T\mathbf{v}_1 + a_2T\mathbf{v}_2 + \cdots + a_nT\mathbf{v}_n \\ &= a_1\mathbf{v}_1 + a_2\mathbf{v}_2 + \cdots + a_n\mathbf{v}_n = \mathbf{v}. \end{aligned}$$

Thus T is the identity operator.

13. $\text{Range } T$ is a subspace of \mathbb{R}^3 which contains the origin. Thus by Example 4.6.9 $\text{Range } T$ is either a) $\{0\}$, b) a line through the origin, c) a plane through the origin or d) \mathbb{R}^3 .
14. $\text{Ker } T$ is a subspace of \mathbb{R}^3 which contains the origin. So as in Problem 13 $\text{Ker } T$ is either a) $\{0\}$, b) a line through the origin, c) a plane through the origin or d) \mathbb{R}^3 .
15. $T\mathbf{x} = A\mathbf{x}$ where $A = \begin{pmatrix} 0 & a \\ b & c \end{pmatrix}$, $a, b, c \in \mathbb{R}$. i.e. $T \begin{pmatrix} 1 \\ 0 \end{pmatrix} = \begin{pmatrix} 0 \\ b \end{pmatrix}$, $T \begin{pmatrix} 0 \\ 1 \end{pmatrix}$ is arbitrary.
16. $T\mathbf{x} = A\mathbf{x}$ where $A = \begin{pmatrix} c & (l-c)/a \\ d & (b-d)/a \end{pmatrix}$, where $c, d \in \mathbb{R}$.

17. Note that a basis for $\text{ker } T$ is $\left\{ \begin{pmatrix} 1 \\ 0 \\ -2 \end{pmatrix}, \begin{pmatrix} 0 \\ 1 \\ 1 \end{pmatrix} \right\}$. Then we want $T \begin{pmatrix} 1 \\ 0 \\ -2 \end{pmatrix} = \begin{pmatrix} 0 \\ 0 \\ 0 \end{pmatrix}$ and $T \begin{pmatrix} 0 \\ 1 \\ 1 \end{pmatrix} = \begin{pmatrix} 0 \\ 0 \\ 0 \end{pmatrix}$. Let $T = \begin{pmatrix} 2 & -1 & 1 \\ 2 & -1 & 1 \\ 2 & -1 & 1 \end{pmatrix}$.

18. Note that a basis for Range T is $\left\{ \begin{pmatrix} 1 \\ 0 \\ -2 \end{pmatrix}, \begin{pmatrix} 0 \\ 1 \\ 1 \end{pmatrix} \right\}$. Then for any $\begin{pmatrix} x \\ y \\ z \end{pmatrix}$, we want $T \begin{pmatrix} x \\ y \\ z \end{pmatrix} = c_1 \begin{pmatrix} 1 \\ 0 \\ -2 \end{pmatrix} + c_2 \begin{pmatrix} 0 \\ 1 \\ 1 \end{pmatrix}$ for some $c_1, c_2 \in \mathbb{R}$. Let $T = \begin{pmatrix} 1 & 0 & 0 \\ 0 & 1 & 0 \\ -2 & 1 & 0 \end{pmatrix}$.
19. (a) If $A \in \ker T$ then $A - A^t = O$. So $A = A^t$. That is, A is symmetric. Conversely, if $A = A^t$, then $A - A^t = O$, so $A \in \ker T$.
 (b) If $A \in \text{Range } T$ then there exists a matrix B such that $A = B - B^t$. Then $A^t = (B - B^t)^t = B^t - B = -A$. That is, A is skew-symmetric. Conversely if $A^t = -A$, then $T(\frac{1}{2}A) = \frac{1}{2}A - \frac{1}{2}A^t = A$.
20. $\text{Ker } T = \{f \in C^1[0, 1] : xf'(x) = 0 \text{ for } x \in [0, 1]\}$. Then we must have $f'(x) = 0$ all x . Then $f(x)$ constant if $f \in \ker T$. $\text{Range } T = \{xf(x) : f(x) \in C[0, 1]\}$
21. Choose bases $\{\mathbf{u}_1, \dots, \mathbf{u}_n\}$ for V , $\{\mathbf{w}_1, \dots, \mathbf{w}_m\}$ for W . Then let $T_{ij}(\mathbf{u}_i) = \mathbf{w}_j$ and $T_{ij}(\mathbf{u}_k) = 0$ if $k \neq i$. These form a basis for $L(V, W)$ since any \mathbf{v}_k is a linear combination of \mathbf{w}_j , so T with $T(\mathbf{u}_k) = \mathbf{v}_k$ is a linear combination of T_{ij} . Specifically, if $\mathbf{v}_k = \sum c_{kj}\mathbf{w}_j$, $k = 1, \dots, n$, then $T = \sum_{kj} c_{kj}T_{kj}$. Independence of T_{ij} follows from $\sum a_{ij}T_{ij}(\mathbf{u}_i) = \sum a_{ij}\mathbf{w}_j = 0 \Rightarrow a_{ij} = 0$. Therefore, $\dim L(V, W) = nm$.
22. (a) Suppose $T_1, T_2 \in U$. Then for every $\mathbf{h} \in H$, $(T_1 + T_2)\mathbf{h} = T_1\mathbf{h} + T_2\mathbf{h} = \mathbf{0} + \mathbf{0} = \mathbf{0}$, and $(\alpha T_1)\mathbf{h} = \alpha(T_1\mathbf{h}) = \alpha \cdot \mathbf{0} = \mathbf{0}$. Then U is a subspace of $L(V, V)$.
 (b) $\dim U = n(n - k)$. In fact extending $\{\mathbf{u}_1, \dots, \mathbf{u}_k\}$, a basis of H , to $\{\mathbf{u}_1, \dots, \mathbf{u}_n\}$ a basis of V , then T is in U if and only if $T(\mathbf{u}_1) = \dots = T(\mathbf{u}_k) = 0$. In particular $T(\mathbf{u}_{k+1}), \dots, T(\mathbf{u}_n)$ are $n - k$ arbitrary vectors in the n dimensional space V . So if $T_{ij}(\mathbf{u}_i) = \mathbf{u}_j$, $T_{ij}(\mathbf{u}_l) = 0, l \neq i$ for $k < i \leq n, 1 \leq j \leq n$, then T_{ij} are a basis for U . (See solution to previous problem.)
23. No. Let $S = \begin{pmatrix} 0 & 1 \\ 0 & 0 \end{pmatrix}$ and $T = \begin{pmatrix} 1 & 0 \\ 0 & 0 \end{pmatrix}$. Then $ST = \begin{pmatrix} 0 & 0 \\ 0 & 0 \end{pmatrix} = \text{zero transformation}$, and $TS = \begin{pmatrix} 0 & 1 \\ 0 & 0 \end{pmatrix} \neq \text{zero transformation}$.

Section 5.3

- As $T \begin{pmatrix} 1 \\ 0 \end{pmatrix} = \begin{pmatrix} -1 \\ 1 \end{pmatrix}$ and $T \begin{pmatrix} 0 \\ 1 \end{pmatrix} = \begin{pmatrix} -2 \\ 1 \end{pmatrix}$, then $A_T = \begin{pmatrix} 1 & -2 \\ -1 & 1 \end{pmatrix}$. Since $\det A_T = -1 \neq 0$, then $\ker T = \{0\}$, $\text{range } T = \mathbb{R}^2$, $\nu(T) = 0$, and $\rho(T) = 2$.
- Since $T \begin{pmatrix} 1 \\ 0 \end{pmatrix} = \begin{pmatrix} 1 \\ 1 \\ 2 \end{pmatrix}$ and $T \begin{pmatrix} 0 \\ 1 \end{pmatrix} = \begin{pmatrix} 1 \\ -1 \\ 3 \end{pmatrix}$, then $A_T = \begin{pmatrix} 1 & 1 \\ 1 & -1 \\ 2 & 3 \end{pmatrix}$. As columns not collinear, then $\rho(A_T) = \rho(T) = 2$, and hence $\nu(T) = 2 - \rho(T) = 0$. Thus $\ker T = \{0\}$ and $\text{range } T = \text{span} \left\{ \begin{pmatrix} 1 \\ 1 \\ 2 \end{pmatrix}, \begin{pmatrix} 1 \\ -1 \\ 3 \end{pmatrix} \right\}$.
- We have $T \begin{pmatrix} 1 \\ 0 \\ 0 \end{pmatrix} = \begin{pmatrix} 1 \\ -2 \\ 0 \end{pmatrix}$, $T \begin{pmatrix} 0 \\ 1 \\ 0 \end{pmatrix} = \begin{pmatrix} -1 \\ 2 \\ 0 \end{pmatrix}$, and $T \begin{pmatrix} 0 \\ 0 \\ 1 \end{pmatrix} = \begin{pmatrix} 1 \\ -2 \\ 1 \end{pmatrix}$, so that $A_T = \begin{pmatrix} 1 & -1 & 1 \\ -2 & 2 & -2 \end{pmatrix}$. As $A_T \rightarrow \begin{pmatrix} 1 & -1 & 1 \\ 0 & 0 & 0 \end{pmatrix}$, then $\rho(A) = \rho(T) = 1$, $\nu(T) = 3 - \rho(T) = 2$, $\text{range } T = \text{span} \left\{ \begin{pmatrix} 1 \\ -2 \end{pmatrix} \right\}$, and $\ker T = \text{span} \left\{ \begin{pmatrix} 1 \\ 1 \\ 0 \end{pmatrix}, \begin{pmatrix} 0 \\ 1 \\ 1 \end{pmatrix} \right\}$, from $T\mathbf{x} = 0$ only if $\mathbf{x} = \begin{pmatrix} x_1 \\ x_1 - x_3 \\ x_3 \end{pmatrix}$.
- As $T \begin{pmatrix} 1 \\ 0 \end{pmatrix} = \begin{pmatrix} a \\ c \end{pmatrix}$ and $T \begin{pmatrix} 0 \\ 1 \end{pmatrix} = \begin{pmatrix} b \\ d \end{pmatrix}$, then $A_T = \begin{pmatrix} a & b \\ c & d \end{pmatrix}$. If $a = b = c = d = 0$, then T is the zero transformation, and hence $\rho(T) = 0$, $\nu(T) = 2$, $\ker T = \mathbb{R}^2$, and $\text{range } T = \{0\}$. If $ad - cb \neq 0$, then $\rho(T) = 2$, $\nu(T) = 0$, $\ker T = \{0\}$, and $\text{range } T = \mathbb{R}^2$. Suppose $ad - bc = 0$, and suppose at least one of a, b, c , or d are nonzero. We may assume $a \neq 0$. Then $\rho(T) = 1$, $\nu(T) = 1$, $\ker T = \text{span} \left\{ \begin{pmatrix} -b \\ a \end{pmatrix} \right\}$, and $\text{range } T = \text{span} \left\{ \begin{pmatrix} a \\ c \end{pmatrix} \right\}$.
- $A_T = \begin{pmatrix} 1 & -1 & 2 \\ 3 & 1 & 4 \\ 5 & -1 & 8 \end{pmatrix}$. Since $A_T \rightarrow \begin{pmatrix} 1 & 0 & 3/2 \\ 0 & 1 & -1/2 \\ 0 & 0 & 0 \end{pmatrix}$ then $\rho(T) = 2 = \# \text{ pivots}$, $\nu(T) = 1$, and $\text{range } T = \text{span} \left\{ \begin{pmatrix} 1 \\ 3 \\ 5 \end{pmatrix}, \begin{pmatrix} -1 \\ 1 \\ -1 \end{pmatrix} \right\}$. Also $\ker T = \text{span} \left\{ \begin{pmatrix} -3 \\ 1 \\ 2 \end{pmatrix} \right\}$.
- $A_T = \begin{pmatrix} -1 & 2 & 1 \\ 2 & -4 & -2 \\ -3 & 6 & 3 \end{pmatrix}$. Since $A_T \rightarrow \begin{pmatrix} 1 & -2 & -1 \\ 0 & 0 & 0 \\ 0 & 0 & 0 \end{pmatrix}$, then $\rho(T) = 1$, $\nu(T) = 2$, $\text{kernel } T = \text{span} \left\{ \begin{pmatrix} 1 \\ 0 \\ 1 \end{pmatrix}, \begin{pmatrix} 2 \\ 1 \\ 0 \end{pmatrix} \right\}$ and $\text{range } T = \text{span} \left\{ \begin{pmatrix} 1 \\ -2 \\ 3 \end{pmatrix} \right\}$.
- $A_T = \begin{pmatrix} 1 & -1 & 2 & 3 \\ 0 & 1 & 4 & 3 \\ 1 & 0 & 6 & 6 \end{pmatrix}$. As $A_T \rightarrow \begin{pmatrix} 1 & 0 & 6 & 6 \\ 0 & 1 & 4 & 3 \\ 0 & 0 & 0 & 0 \end{pmatrix}$, then $\rho(T) = 2$, $\nu(T) = 2$, and $\ker T = \text{span} \left\{ \begin{pmatrix} -6 \\ -3 \\ 0 \\ 1 \end{pmatrix}, \begin{pmatrix} -6 \\ -4 \\ 1 \\ 0 \end{pmatrix} \right\}$
Also since pivots in columns 1 and 2, $\text{range } T = \text{span} \left\{ \begin{pmatrix} 1 \\ 0 \\ 1 \end{pmatrix}, \begin{pmatrix} -1 \\ 1 \\ 0 \end{pmatrix} \right\}$.

8. $A_T = \begin{pmatrix} 1 & -1 & 2 & 1 \\ -1 & 0 & 1 & 2 \\ 1 & -2 & 5 & 4 \\ 2 & -1 & 1 & -1 \end{pmatrix}$. As $A_T \rightarrow \begin{pmatrix} 1 & 0 & -1 & -2 \\ 0 & 1 & -3 & -3 \\ 0 & 0 & 0 & 0 \\ 0 & 0 & 0 & 0 \end{pmatrix}$, then $\rho(T) = 2$, $\nu(T) = 2$, and $\ker T = \text{span} \left\{ \begin{pmatrix} 1 \\ 3 \\ 1 \\ 0 \end{pmatrix}, \begin{pmatrix} 2 \\ 3 \\ 0 \\ 1 \end{pmatrix} \right\}$;
 $\text{range } T = \text{span} \left\{ \begin{pmatrix} 1 \\ -1 \\ 1 \\ 2 \end{pmatrix}, \begin{pmatrix} -1 \\ 0 \\ -2 \\ -1 \end{pmatrix} \right\}$.
9. $T \begin{pmatrix} 1 \\ -2 \end{pmatrix} = \begin{pmatrix} 5 \\ 0 \end{pmatrix} = \frac{5}{4} \begin{pmatrix} 1 \\ -2 \end{pmatrix} + \frac{5}{4} \begin{pmatrix} 3 \\ 2 \end{pmatrix}$, and $T \begin{pmatrix} 3 \\ 2 \end{pmatrix} = \begin{pmatrix} -1 \\ 8 \end{pmatrix} = \frac{-13}{4} \begin{pmatrix} 1 \\ -2 \end{pmatrix} + \frac{3}{4} \begin{pmatrix} 3 \\ 2 \end{pmatrix}$. So
 $A_T = \begin{pmatrix} 5/4 & -13/4 \\ 5/4 & 3/4 \end{pmatrix}$. As $\det A_T = 5 \neq 0$, then $\rho(T) = 2$, $\nu(T) = 0$, $\ker T = \{0\}$, and $\text{range } T = \mathbb{R}^2$.
10. $T \begin{pmatrix} -1 \\ 1 \end{pmatrix} = \begin{pmatrix} -5 \\ -1 \end{pmatrix} = \frac{11}{7} \begin{pmatrix} -1 \\ 1 \end{pmatrix} - \frac{6}{7} \begin{pmatrix} 4 \\ 3 \end{pmatrix}$, and $T \begin{pmatrix} 4 \\ 3 \end{pmatrix} = \begin{pmatrix} 13 \\ 18 \end{pmatrix} = \frac{33}{7} \begin{pmatrix} -1 \\ 1 \end{pmatrix} + \frac{31}{7} \begin{pmatrix} 4 \\ 3 \end{pmatrix}$. Hence,
 $A_T = \begin{pmatrix} 11/7 & 33/7 \\ -6/7 & 31/7 \end{pmatrix}$. As $\det A_T = 11 \neq 0$, then $\rho(T) = 2$, $\nu(T) = 0$, $\ker T = \{0\}$, and $\text{range } T = \mathbb{R}^2$.
11. $T \begin{pmatrix} 1 \\ 0 \\ 1 \end{pmatrix} = \begin{pmatrix} 3 \\ -3 \end{pmatrix} = 3 \begin{pmatrix} 1 \\ -1 \end{pmatrix} + 0 \begin{pmatrix} 2 \\ 3 \end{pmatrix}$, $T \begin{pmatrix} 1 \\ 1 \\ 0 \end{pmatrix} = \begin{pmatrix} 3 \\ 1 \end{pmatrix} = \frac{7}{5} \begin{pmatrix} 1 \\ -1 \end{pmatrix} + \frac{4}{5} \begin{pmatrix} 2 \\ 3 \end{pmatrix}$, and $T \begin{pmatrix} 1 \\ 1 \\ 1 \end{pmatrix} = \begin{pmatrix} 4 \\ -2 \end{pmatrix} = \frac{16}{5} \begin{pmatrix} 1 \\ -1 \end{pmatrix} + \frac{2}{5} \begin{pmatrix} 2 \\ 3 \end{pmatrix}$. Hence, $A_T = \begin{pmatrix} 3 & 7/5 & 16/5 \\ 0 & 4/5 & 2/5 \end{pmatrix}$. As $\begin{pmatrix} 3 & 7/5 & 16/5 \\ 0 & 4/5 & 2/5 \end{pmatrix} \rightarrow \begin{pmatrix} 1 & 0 & 5/6 \\ 0 & 1 & 1/2 \end{pmatrix}$, then
 $\rho(T) = 2$, $\nu(T) = 3 - 2 = 1$, $\text{range } T = \mathbb{R}^2$, and $(\ker T)_{B_1} = \text{span} \left\{ \begin{pmatrix} 5 \\ 3 \\ -6 \end{pmatrix} \right\}$.
12. $T \begin{pmatrix} 2 \\ 1 \end{pmatrix} = \begin{pmatrix} 1 \\ 5 \\ 1 \end{pmatrix} = \begin{pmatrix} 1 \\ -1 \\ 0 \end{pmatrix} + \frac{14}{5} \begin{pmatrix} 0 \\ 2 \\ 0 \end{pmatrix} + \frac{1}{5} \begin{pmatrix} 0 \\ 2 \\ 5 \end{pmatrix}$, and $T \begin{pmatrix} 1 \\ 2 \end{pmatrix} = \begin{pmatrix} -1 \\ 4 \\ 2 \end{pmatrix} = - \begin{pmatrix} 1 \\ -1 \\ 0 \end{pmatrix} + \frac{11}{10} \begin{pmatrix} 0 \\ 2 \\ 0 \end{pmatrix} + \frac{2}{5} \begin{pmatrix} 0 \\ 2 \\ 5 \end{pmatrix}$. Thus $A_T = \begin{pmatrix} 1 & -1 \\ 14/5 & 11/10 \\ 1/5 & 2/5 \end{pmatrix}$. Since $\begin{pmatrix} 1 & -1 \\ 14/5 & 11/10 \\ 1/5 & 2/5 \end{pmatrix} \rightarrow \begin{pmatrix} 1 & 0 \\ 0 & 1 \\ 0 & 0 \end{pmatrix}$, then $\rho(T) = 2$,
 $\nu(T) = 0$, $\ker T = \{0\}$, and $(\text{range } T)_{B_2} = \text{span} \left\{ \begin{pmatrix} 1 \\ 14/5 \\ 1/5 \end{pmatrix}, \begin{pmatrix} -1 \\ 11/10 \\ 2/5 \end{pmatrix} \right\}$.
13. $T(1) = x^3$, $T(x) = 1 - x$, and $T(x^2) = 0$. Hence $A_T = \begin{pmatrix} 0 & 1 & 0 \\ 0 & -1 & 0 \\ 0 & 0 & 0 \\ 1 & 0 & 0 \end{pmatrix}$, $\rho(T) = 2$, $\nu(T) = 1$, $\text{range } T = \text{span} \{x^3, -x + 1\}$, and $\ker T = \text{span} \{x^2\}$.
14. $A_T = \begin{pmatrix} 1 \\ 1 \\ 1 \\ 1 \end{pmatrix}$, $\rho(T) = 1$, $\nu(T) = 0$, $\text{range } T = \text{span} \{1 + x + x^2 + x^3\}$, and $\ker T = \{0\}$.
15. $A_T = (0 \ 0 \ 1 \ 0)$, $\rho(T) = 1$, $\nu(T) = 3$, $\text{range } T = \mathbb{R}$, and $\ker T = \text{span} \{1, x, x^3\}$.
16. $T(1) = 0$, $T(x) = x$, $T(x^2) = -1$, and $T(x^3) = x$. Thus $A_T = \begin{pmatrix} 0 & 0 & -1 & 0 \\ 0 & 1 & 0 & 1 \end{pmatrix}$. So $\rho(T) = 2$, $\nu(T) = 2$, $\text{range } T = P_1$, and $\ker T = \text{span} \{1, x^3 - x\}$.

17. $T(1) = 1 + x^2$, $T(x) = -1 + x$, $T(x^2) = 2 + 4x + 6x^2$, and $T(x^3) = 3 + 3x + 5x^2$. So $A_T = \begin{pmatrix} 1 & -1 & 2 & 3 \\ 0 & 1 & 4 & 3 \\ 1 & 0 & 6 & 5 \end{pmatrix}$. As

$$\begin{pmatrix} 1 & -1 & 2 & 4 \\ 0 & 1 & 4 & 3 \\ 1 & 0 & 6 & 5 \end{pmatrix} \rightarrow \begin{pmatrix} 1 & 0 & 6 & 0 \\ 0 & 1 & 4 & 0 \\ 0 & 0 & 0 & 1 \end{pmatrix}, \text{ then } \rho(T) = 3, \nu(T) = 1, \text{ range } T = P_2,$$

$$\ker T = \text{span}\{6 + 4x - x^2\}.$$

18. $T\begin{pmatrix} 1 & 0 \\ 0 & 0 \end{pmatrix} = \begin{pmatrix} 1 & -1 \\ 1 & 2 \end{pmatrix}$, $T\begin{pmatrix} 0 & 1 \\ 0 & 0 \end{pmatrix} = \begin{pmatrix} -1 & 0 \\ -2 & -1 \end{pmatrix}$, $T\begin{pmatrix} 0 & 0 \\ 1 & 0 \end{pmatrix} = \begin{pmatrix} 2 & 2 \\ 5 & 1 \end{pmatrix}$, and $T\begin{pmatrix} 0 & 0 \\ 0 & 1 \end{pmatrix} = \begin{pmatrix} 1 & 2 \\ 4 & -1 \end{pmatrix}$. Hence

$$A_T = \begin{pmatrix} 1 & -1 & 2 & 1 \\ -1 & 0 & 2 & 2 \\ 1 & -2 & 5 & 4 \\ 2 & -1 & 1 & -1 \end{pmatrix}. \text{ As } \begin{pmatrix} 1 & -1 & 2 & 1 \\ -1 & 0 & 2 & 2 \\ 1 & -2 & 5 & 4 \\ 2 & -1 & 1 & -1 \end{pmatrix} \rightarrow \begin{pmatrix} 1 & 0 & 0 & -2 \\ 0 & 1 & 0 & -3 \\ 0 & 0 & 1 & 0 \\ 0 & 0 & 0 & 0 \end{pmatrix}, \text{ then } \rho(T) = 3, \nu(T) = 1, \ker T =$$

$$\text{span}\left\{\begin{pmatrix} 2 & 3 \\ 0 & 1 \end{pmatrix}\right\}. \text{ Since pivots in columns 1-3, Range } T = \text{span}\left\{\begin{pmatrix} 1 & -1 \\ 1 & 2 \end{pmatrix}, \begin{pmatrix} -1 & 0 \\ -2 & -1 \end{pmatrix}, \begin{pmatrix} 2 & 2 \\ 5 & 1 \end{pmatrix}\right\}.$$

19. $T\begin{pmatrix} 1 & 0 \\ 0 & 0 \end{pmatrix} = \begin{pmatrix} 1 & 1 \\ 1 & 1 \end{pmatrix}$, $T\begin{pmatrix} 0 & 1 \\ 0 & 0 \end{pmatrix} = \begin{pmatrix} 1 & 1 \\ 1 & 0 \end{pmatrix}$, $T\begin{pmatrix} 0 & 0 \\ 1 & 0 \end{pmatrix} = \begin{pmatrix} 1 & 1 \\ 0 & 0 \end{pmatrix}$, and $T\begin{pmatrix} 0 & 0 \\ 0 & 1 \end{pmatrix} = \begin{pmatrix} 1 & 0 \\ 0 & 0 \end{pmatrix}$. Thus

$$A_T = \begin{pmatrix} 1 & 1 & 1 & 1 \\ 1 & 1 & 1 & 0 \\ 1 & 1 & 0 & 0 \\ 1 & 0 & 0 & 0 \end{pmatrix}. \text{ So } \rho(T) = 4, \nu(T) = 0, \text{ range } T = M_{22}, \text{ and } \ker T = \{0\}.$$

20. $T(1) = x = (x+1) - 1$, $T(x) = x^2 = (x+1)^2 - 2(x+1) + 1$, and $T(x^2) = x^3 = (x+1)^3 -$

$$3(x+1)^2 + 3(x+1) - 1, \text{ and hence } A_T = \begin{pmatrix} -1 & 1 & -1 \\ 1 & -2 & 3 \\ 0 & 1 & -3 \\ 0 & 0 & 1 \end{pmatrix}. \text{ So } \rho(T) = 3, \nu(T) = 0, \ker T = \{0\}, \text{ and}$$

$$\text{range } T = \text{span}\{x, x^2, x^3\}.$$

21. $D(1) = 0$, $D(x) = 1$, $D(x^2) = 2x$, $D(x^3) = 3x^2$, and $D(x^4) = 4x^3$. So $A_D = \begin{pmatrix} 0 & 1 & 0 & 0 & 0 \\ 0 & 0 & 2 & 0 & 0 \\ 0 & 0 & 0 & 3 & 0 \\ 0 & 0 & 0 & 0 & 4 \end{pmatrix}$, and hence,

$$\rho(D) = 4, \nu(D) = 1, \ker D = P_0, \text{ and range } D = P_3.$$

22. $T(1) = -1$, $T(x) = 0$, $T(x^2) = x^2$, $T(x^3) = 2x^3$, and $T(x^4) = 3x^4$. Thus, $A_T = \begin{pmatrix} -1 & 0 & 0 & 0 & 0 \\ 0 & 0 & 0 & 0 & 0 \\ 0 & 0 & 1 & 0 & 0 \\ 0 & 0 & 0 & 2 & 0 \\ 0 & 0 & 0 & 0 & 3 \end{pmatrix}$, and

$$\text{hence, } \rho(T) = 4, \nu(T) = 1, \ker T = \text{span}\{x\}, \text{ and range } T = \text{span}\{1, x^2, x^3, x^4\}.$$

23. As $D(x^k) = kx^{k-1}$, then $A_D = \begin{pmatrix} 0 & 1 & 0 & 0 & \cdots & 0 \\ 0 & 0 & 2 & 0 & \cdots & 0 \\ 0 & 0 & 0 & 3 & \cdots & 0 \\ \vdots & \vdots & \vdots & \vdots & \ddots & \vdots \\ 0 & 0 & 0 & 0 & \cdots & n \end{pmatrix}$, $\rho(D) = n$, $\nu(D) = 1$, $\text{range } D = P_{n-1}$, and

$$\ker D = P_0.$$

24. $D(1) = 0$, $D(x) = 0$, $D(x^2) = 2$, $D(x^3) = 6x$, and $D(x^4) = 12x^2$. So $A_D = \begin{pmatrix} 0 & 0 & 2 & 0 & 0 \\ 0 & 0 & 0 & 6 & 0 \\ 0 & 0 & 0 & 0 & 12 \end{pmatrix}$, $\rho(D) = 3$,

$\nu(D) = 2$, $\ker D = P_1$, and $\text{range } D = \text{span}\{2, 6x, 12x^2\} = P_2$.

25. $T(1) = 2$, $T(x) = 3x$, $T(x^2) = 4x^2 + 2$, $T(x^3) = 5x^3 + 6x$, $T(x^4) = 6x^4 + 12x^2$. Thus $A_T = \begin{pmatrix} 2 & 0 & 2 & 0 & 0 \\ 0 & 3 & 0 & 6 & 0 \\ 0 & 0 & 4 & 0 & 12 \\ 0 & 0 & 0 & 5 & 0 \\ 0 & 0 & 0 & 0 & 6 \end{pmatrix}$, $\rho(T) = 5$, $\nu(T) = 0$, $\ker T = \{0\}$, and $\text{range } T = P_4$.

26. Let m be a positive integer, and define $(m)_k = m(m-1)(m-2)\cdots(m-k+1)$ where $1 \leq k \leq m$. Then $D(x^m) = (m)_k x^{m-k}$ if $m \geq k$ and is 0 if $m < k$. Thus $A_D = (a_{ij})$ is the $(n-k+1) \times (n+1)$ matrix, where for each $1 \leq i \leq n-k+1$, $a_{i,k+i} = (k+i-1)_k$, and $a_{ij} = 0$ otherwise. So there is a pivot in each row. $\rho(D) = n-k+1$, $\nu(D) = (n+1) - \rho(D) = k$, $\ker D = \text{span}\{1, x, x^2, \dots, x^{k-1}\}$, and $\text{range } D = \text{span}\{1, x, x^2, \dots, x^{n-k}\} = P_{n-k}$.

27. We have $T(x^k) = \left(\sum_{i=0}^k \frac{k!}{(k-i)!}\right) x^k$, and hence $A_T = \text{diag}(b_0, b_1, \dots, b_n)$, where $b_k = \sum_{i=0}^k \frac{k!}{(k-i)!}$.

Thus, $\rho(T) = n+1$, $\nu(T) = 0$, $\ker T = \{0\}$, and $\text{range } T = P_n$.

28. $J(x^k) = \int_0^1 x^k dx = \frac{1}{k+1}$ for each $0 \leq k \leq n$. So $A_J = (1, 1/2, 1/3, \dots, 1/(n+1))$, and hence, $\rho(J) = 1$, $\nu(J) = 0$, $\ker J = \{0\}$, and $\text{range } J = \mathbb{R}$.

29. $A_T = \begin{pmatrix} 1 & 0 & 0 \\ 0 & 1 & 0 \\ 0 & 0 & 1 \end{pmatrix}$, $\rho(T) = 3$, $\nu(T) = 0$, $\text{range } T = P_2$, and $\ker T = \{0\}$.

30. $T(1) = \begin{pmatrix} 0 \\ 0 \\ 0 \end{pmatrix}$, $T(x) = \begin{pmatrix} 0 \\ 1 \\ -1 \end{pmatrix}$, $T(x^2) = \begin{pmatrix} -1 \\ 0 \\ 1 \end{pmatrix}$, and $T(x^3) = \begin{pmatrix} 1 \\ 1 \\ 0 \end{pmatrix}$. Thus $A_T = \begin{pmatrix} 0 & 0 & -1 & 1 \\ 0 & 1 & 0 & 1 \\ 0 & -1 & 1 & 0 \end{pmatrix}$. As $\begin{pmatrix} 0 & 0 & -1 & 1 \\ 0 & 1 & 0 & 1 \\ 0 & -1 & 1 & 0 \end{pmatrix} \rightarrow \begin{pmatrix} 0 & 1 & 0 & 0 \\ 0 & 0 & 1 & 0 \\ 0 & 0 & 0 & 1 \end{pmatrix}$, then $\rho(T) = 3$, $\nu(T) = 1$, $\ker T = P_0$, and $\text{range } T = \mathbb{R}^3$.

31. Let $E_{rs} \in M_{mn}$ be the $m \times n$ matrix with $e_{ij} = 1$ if $i = r, j = s$, and 0 otherwise. Then $TE_{rs} = E_{sr} \in M_{nm}$, and $A_T = (a_{ij})$ where

$$a_{ij} = \begin{cases} 1, & \text{if } i = (k-1)m + \ell, \text{ and } j = (\ell-1)n + k \text{ for } k = 1, 2, \dots, n \text{ and } \ell = 1, 2, \dots, m \\ 0, & \text{otherwise} \end{cases}$$

32. $T\begin{pmatrix} 1 \\ 0 \end{pmatrix} = \begin{pmatrix} 1 \\ -1 \end{pmatrix}$ and $T\begin{pmatrix} 0 \\ 1 \end{pmatrix} = \begin{pmatrix} i \\ 1+i \end{pmatrix}$. So $A_T = \begin{pmatrix} 1 & i \\ -1 & 1+i \end{pmatrix}$.

33. $D(1) = 0$, $D(\sin x) = \cos x$, $D(\cos x) = -\sin x$. Thus, $A_D = \begin{pmatrix} 0 & 0 & 0 \\ 0 & 0 & -1 \\ 0 & 1 & 0 \end{pmatrix}$, $\text{range } D = \text{span}(\sin x, \cos x)$,

and $\ker D = \mathbb{R}$.

34. $D(e^x) = e^x$, $D(xe^x) = e^x + xe^x$, and $D(x^2e^x) = 2xe^x + x^2e^x$. Hence $A_D = \begin{pmatrix} 1 & 1 & 0 \\ 0 & 1 & 2 \\ 0 & 0 & 1 \end{pmatrix}$, range $D = V$,

and $\ker D = \{0\}$.

35. $T \begin{pmatrix} 1 \\ 0 \end{pmatrix} = \text{proj}_H \begin{pmatrix} 1 \\ 0 \end{pmatrix} = \begin{pmatrix} 1/2 \\ i/2 \end{pmatrix}$, and $T \begin{pmatrix} 0 \\ 1 \end{pmatrix} = \text{proj}_H \begin{pmatrix} 0 \\ 1 \end{pmatrix} = \begin{pmatrix} -i/2 \\ 1/2 \end{pmatrix}$. So $A_T = \begin{pmatrix} 1/2 & -i/2 \\ i/2 & 1/2 \end{pmatrix}$.

36. (i) By theorem 1, $\mathbf{y} \in \text{range } T$ if and only if $\mathbf{y} \in \text{range } A_T$. So $\text{range } T = \text{range } A_T$.

(ii) This follows from (i).

(iii) By theorem 1, $T\mathbf{x} = 0$ if and only if $A_T\mathbf{x} = 0$. Thus $\ker T = N_{A_T}$.

(iv) By (iii) $\nu(T) = \dim \ker T = \dim(N_{A_T}) = \nu(A_T)$

37. (i) Let B_1 and B_2 be bases for V and W , respectively. By theorem 3, $(T\mathbf{v})_{B_2} = A_T(\mathbf{v})_{B_1}$. If $\mathbf{w} \in \text{range } T$, then $\mathbf{w} = T\mathbf{v}$ for some $\mathbf{v} \in V$. Hence, $(T\mathbf{v})_{B_2} = (\mathbf{w})_{B_2} = A_T(\mathbf{v})_{B_1}$. So $(\mathbf{w})_{B_2} \in \text{range } A_T$. Similarly, $\text{range } A_T \subset (\text{range } T)_{B_2}$, and hence, $\text{range } A_T = (\text{range } T)_{B_2}$. It follows that $\rho(A_T) = \rho(T)$.

(ii) We have $T\mathbf{v} = 0$ if and only if $(T\mathbf{v})_{B_2} = (0)_{B_2}$ if and only if $A_T(\mathbf{v})_{B_1} = (0)_{B_2}$. Hence, $(\ker T)_{B_1} = \ker A_T$, and $\nu(T) = \nu(A_T)$.

(iii) As $\rho(A_T) + \nu(A_T) = n$ by theorem 4.7.7, we have $\rho(T) + \nu(T) = n$.

38. expansion along the x -axis with $c = 4$

40. reflection about the x -axis

42. shear along the x -axis with $c = -3$

44. shear along the y -axis with $c = -5$

39. possible compression along the y -axis with $c = 1/4$

41. shear along the x -axis with $c = 2$

43. shear along the y -axis with $c = 1/2$

45. reflection about the line $y = x$

46. $\begin{pmatrix} 1 & 0 \\ 0 & 2 \end{pmatrix}$

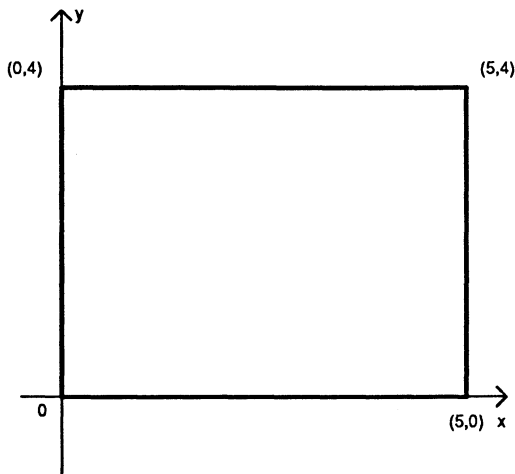

47. $\begin{pmatrix} 1/4 & 0 \\ 0 & 1 \end{pmatrix}$

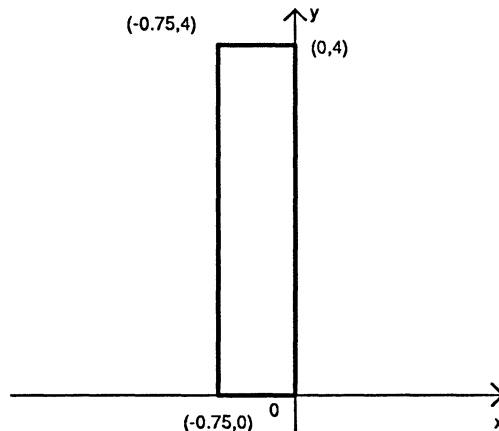

48. $\begin{pmatrix} 1 & -2 \\ 0 & 1 \end{pmatrix}$

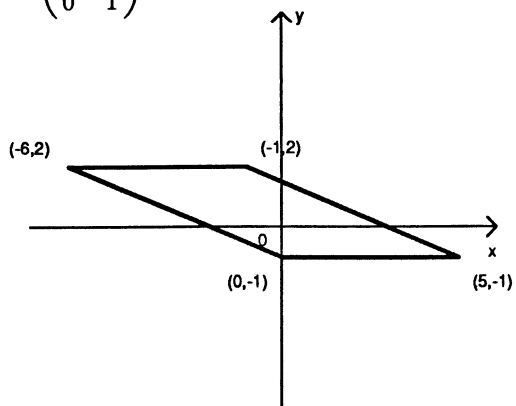

49. $\begin{pmatrix} 1 & 0 \\ 3 & 1 \end{pmatrix}$

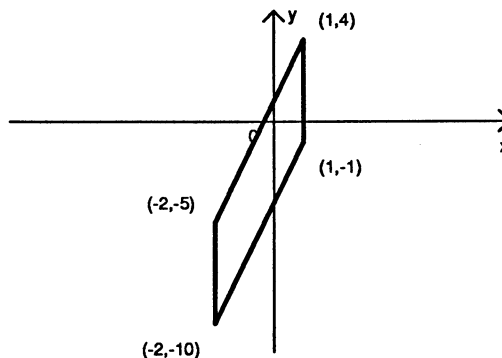

50. $\begin{pmatrix} 1 & 0 \\ -1/2 & 1 \end{pmatrix}$

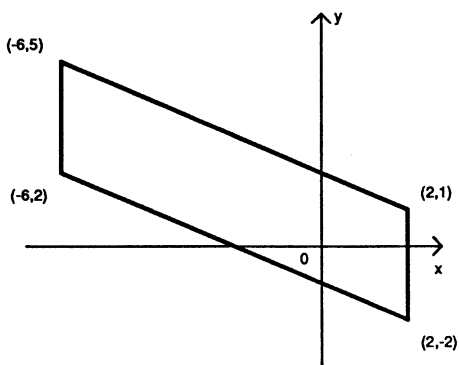

51. $\begin{pmatrix} 1 & 1/5 \\ 0 & 1 \end{pmatrix}$

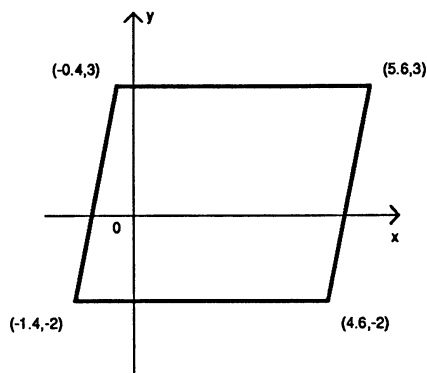

52. $\begin{pmatrix} 1 & 0 \\ 0 & -1 \end{pmatrix}$

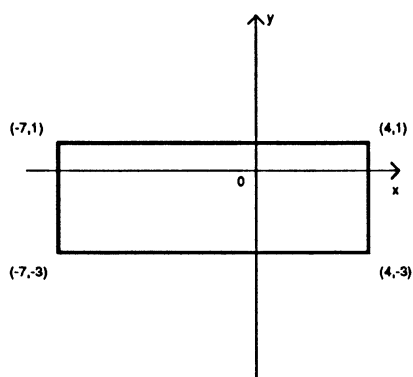

53. $\begin{pmatrix} -1 & 0 \\ 0 & 1 \end{pmatrix}$

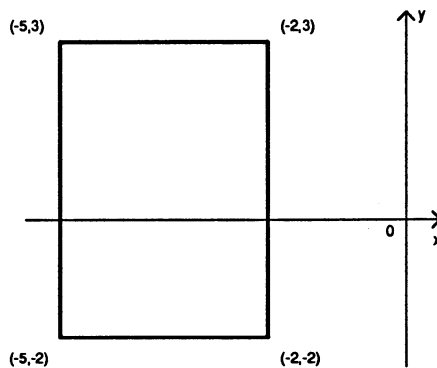

54. $\begin{pmatrix} 0 & 1 \\ 1 & 0 \end{pmatrix}$

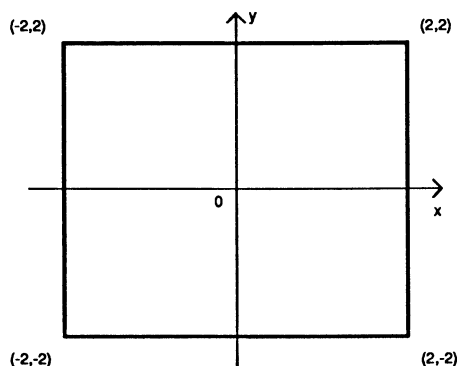

55. $\begin{pmatrix} 0 & 1 \\ 1 & 0 \end{pmatrix}$

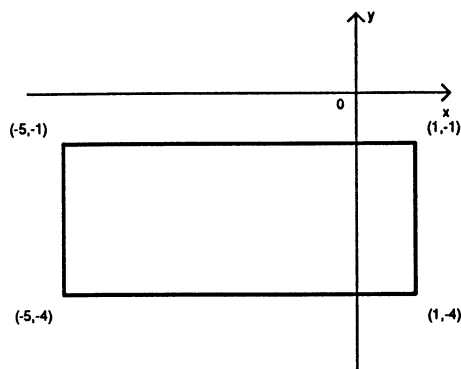

For 56-63 use inverses of elementary transformations which take A_T to reduced echelon form.

56. $\begin{pmatrix} 2 & 0 \\ 0 & 1 \end{pmatrix} \begin{pmatrix} 1 & 0 \\ 5 & 1 \end{pmatrix} \begin{pmatrix} 1 & 0 \\ 0 & 5/2 \end{pmatrix} \begin{pmatrix} 1 & -1/2 \\ 0 & 1 \end{pmatrix}$

58. $\begin{pmatrix} 0 & 1 \\ 1 & 0 \end{pmatrix} \begin{pmatrix} 3 & 0 \\ 0 & 1 \end{pmatrix} \begin{pmatrix} 1 & 0 \\ 0 & -1 \end{pmatrix} \begin{pmatrix} 1 & 0 \\ 0 & 2 \end{pmatrix} \begin{pmatrix} 1 & -5/3 \\ 0 & 1 \end{pmatrix}$

60. $\begin{pmatrix} 0 & 1 \\ 1 & 0 \end{pmatrix} \begin{pmatrix} 1 & 0 \\ 0 & 3 \end{pmatrix} \begin{pmatrix} 1 & -2 \\ 0 & 1 \end{pmatrix}$

62. $\begin{pmatrix} 3 & 0 \\ 0 & 1 \end{pmatrix} \begin{pmatrix} 1 & 0 \\ -4 & 1 \end{pmatrix} \begin{pmatrix} 1 & 0 \\ 0 & 4/3 \end{pmatrix} \begin{pmatrix} 1 & 7/3 \\ 0 & 1 \end{pmatrix}$

57. $\begin{pmatrix} 3 & 0 \\ 0 & 1 \end{pmatrix} \begin{pmatrix} 1 & 0 \\ -1 & 1 \end{pmatrix} \begin{pmatrix} 1 & 0 \\ 0 & 14/3 \end{pmatrix} \begin{pmatrix} 1 & 2/3 \\ 0 & 1 \end{pmatrix}$

59. $\begin{pmatrix} 3 & 0 \\ 0 & 1 \end{pmatrix} \begin{pmatrix} 1 & 0 \\ 4 & 1 \end{pmatrix} \begin{pmatrix} 1 & 0 \\ 0 & -1 \end{pmatrix} \begin{pmatrix} 1 & 0 \\ 0 & 6 \end{pmatrix} \begin{pmatrix} 1 & 2 \\ 0 & 1 \end{pmatrix}$

61. $\begin{pmatrix} 0 & 1 \\ 1 & 0 \end{pmatrix} \begin{pmatrix} 5 & 0 \\ 0 & 1 \end{pmatrix} \begin{pmatrix} 1 & 0 \\ 0 & -1 \end{pmatrix} \begin{pmatrix} 1 & 0 \\ 0 & 2 \end{pmatrix} \begin{pmatrix} 1 & 7/5 \\ 0 & 1 \end{pmatrix}$

63. $\begin{pmatrix} -1 & 0 \\ 0 & 1 \end{pmatrix} \begin{pmatrix} 1 & 0 \\ 6 & 1 \end{pmatrix} \begin{pmatrix} 1 & 0 \\ 0 & 62 \end{pmatrix} \begin{pmatrix} 1 & -10 \\ 0 & 1 \end{pmatrix}$

MATLAB 5.3

The Solutions to 5.1 explain the addition of a line type argument to 'graphics'.

1. To recreate Figure 5.8(a) we use

```
>> pts=[[0 0]' [3 0]' [3 2]' [0 2]'];
>> lns=[[1 2]' [2 3]' [3 4]' [4 1]'];
>> graphics(pts,lns,'r','*',5,'-');
>> print -deps fig531.eps
```

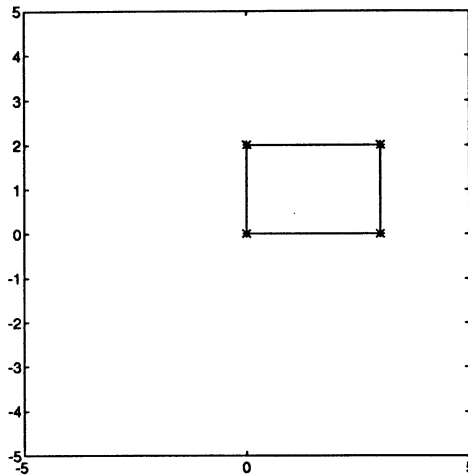

(a)

```
>> A=[.5 0 ; 0 3]; % Expand y-axis by factor of 3, compress x-axis factor .5
>> graphics(pts,lns,'r','*',10,':')
>> hold on
>> graphics(A*pts,lns,'b','+',10,'--')
>> hold off
>> print -deps fig531a.eps
```

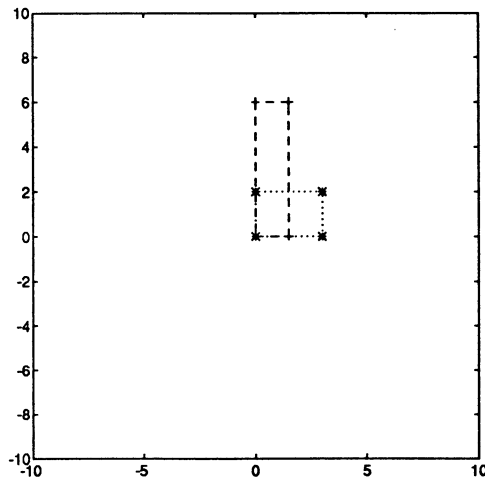

(b) Recreate the shear transformations in Figures 5.8(b),(c).

```
>> A=[1 2 ; 0 1]; % Shear along x-axis, c=2 , Fig. 5.8(b)
>> subplot(121); graphics(pts,lns,'r','*',7,':')
>> hold on
>> graphics(A*pts,lns,'b','+',7,'--')
>> title('Fig. 5.8. (a) and (b)')
>> hold off
>> A=[1 -2 ; 0 1]; % Shear along x-axis, c=-2 , Fig. 5.8(c)
>> subplot(122); graphics(pts,lns,'r','*',7,':')
>> hold on
>> graphics(A*pts,lns,'b','+',7,'--')
>> title('Fig. 5.8. (a) and (c)')
>> hold off
>> print -deps fig531b.eps
```

Fig. 5.8. (a) and (b)

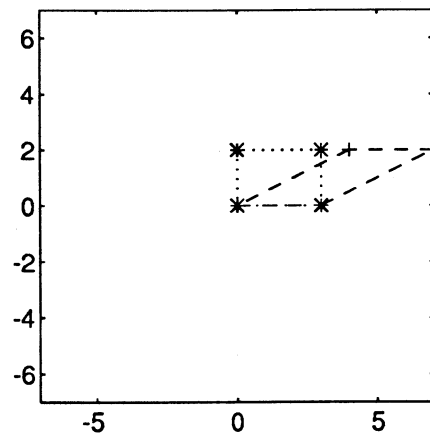
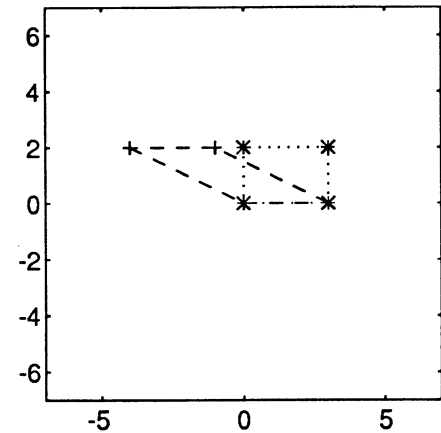
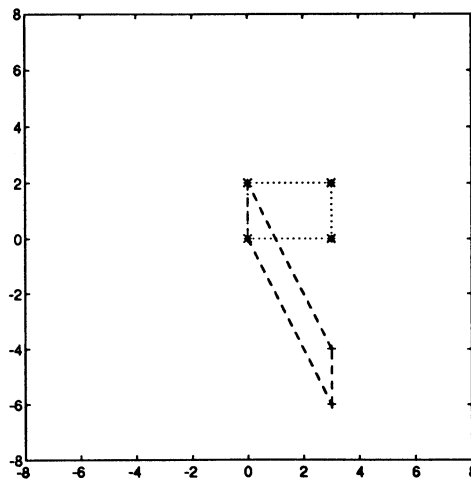

Fig. 5.8. (a) and (c)



(c) A shear transformation along y-axis

```
>> A=[1 0; -2 1]; % Shear along y-axis, c=-2
>> graphics(pts,lns,'r','*',8,':')
>> hold on
>> graphics(A*pts,lns,'b','+',8,'--')
>> hold off
>> print -deps fig531c.eps
```



2. (a) The matrix R for rotation counterclockwise by $\pi/2$ is given by $R = (R(e_1) R(e_2)) = \begin{pmatrix} 0 & -1 \\ 1 & 0 \end{pmatrix}$ since the x -axis goes to the y -axis and the y -axis goes to the negative x -axis. The matrix E for expansion along the x -axis by a factor of 2 is $\begin{pmatrix} 2 & 0 \\ 0 & 1 \end{pmatrix}$.

(b)

```
>> pts = [ 0 3 3 8 8 11 11 15 15 11 8 8 0 10;...
>>         0 0 3 3 0 0 7 7 10 10 12 7 7 9];
>> lns = [ 1:13 ; [ 2:13 1 ] ];
>> R = [ 0 -1; 1 0]; % Rotation by pi/2 counterclockwise
>> E = [ 2 0; 0 1]; % Expansion along the x-axis by a factor of 2
>> subplot(121); graphics(pts,lns,'r','*',30,':');
>> hold on
>> graphics(E*R*pts,lns,'b','o',30,'--');
>> title('Original - dotted')
>> xlabel('Rotated then expanded - dashed')
>> hold off
>> subplot(122); graphics(pts,lns,'r','*',30,':');
>> hold on
>> graphics(R*E*pts,lns,'w','+',30,'--');
>> xlabel('Expanded then rotated - dashed')
>> hold off
>> print -deps fig532b.eps
```

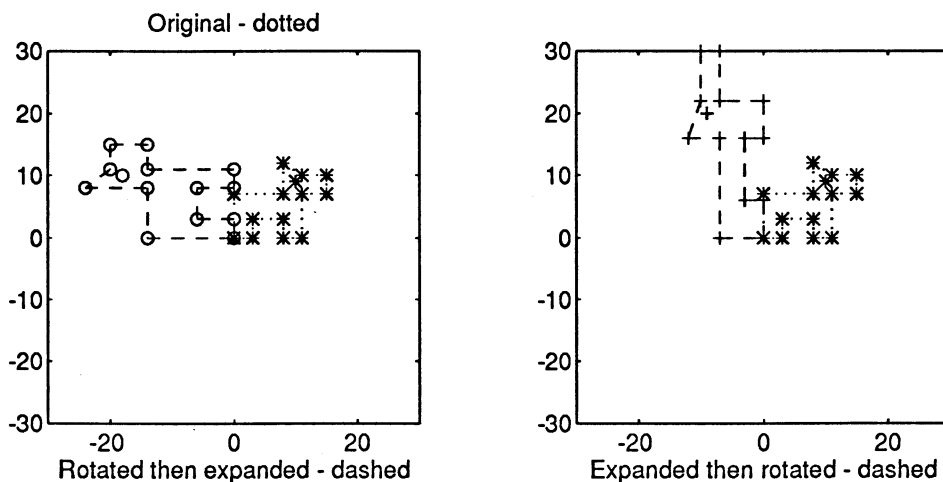

3. (a) $T(x) = \text{proj}_v x = (v \cdot x)v$ is linear since $(v \cdot (x_1 + x_2))v = ((v \cdot x_1) + (v \cdot x_2))v = (v \cdot x_1)v + (v \cdot x_2)v$ and $(v \cdot \alpha x)v = (\alpha(v \cdot x))v = \alpha(v \cdot x)v$. The matrix for P for T has $T(e_j)$ for its j th column. Since $(v \cdot e_j) = v_j$, this means $P = (v_1 v \ v_2 v \ \dots \ v_n v)$.
- (b) (i)

```
>> v = [1 0]';
>> P = [v(1)*v v(2)*v];
>> graphics(pts,lns,'r','o',20,':')
>> hold on
>> graphics(P*pts,lns,'w','+',20,'--')
>> print -deps fig533bi.eps
```

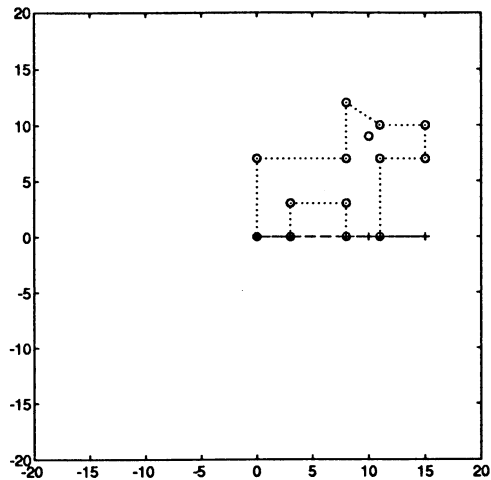

- (ii) The kernel of P is $\{\mathbf{x} : (\mathbf{v} \cdot \mathbf{x}) = 0\}$ which is just all vectors perpendicular to \mathbf{v} , i.e. the y -axis. (That is just saying that every vector perpendicular to \mathbf{v} projects to zero.) The range of P is just the set of all multiples of \mathbf{v} , since every column of P has this form. Alternatively projection on \mathbf{v} gives multiples of \mathbf{v} .

(c)

```
>> w = [1 1]'; v = (1/norm(w))*w;
>> P = [v(1)*v v(2)*v];
>> graphics(pts,lns,'r','o',20,':')
>> hold on
>> graphics(P*pts,lns,'w','+', 20,'--')
>> print -deps fig533c.eps
```

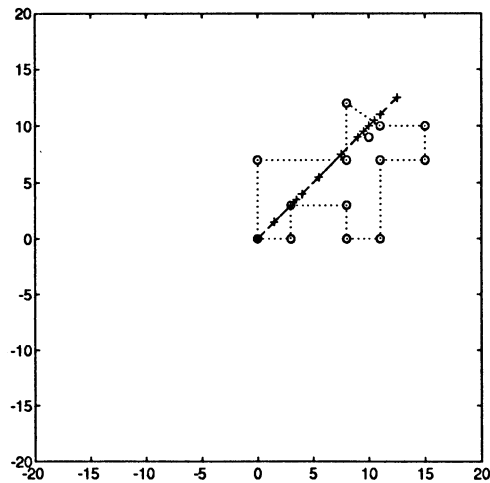

(d)

```
>> w = [-1 1]'; v = (1/norm(w))*w;
>> P = [v(1)*v v(2)*v];
>> graphics(pts,lns,'r','o',20,':')
>> hold on
>> graphics(P*pts,lns,'w','+', 20,'--')
>> print -deps fig533d.eps
```

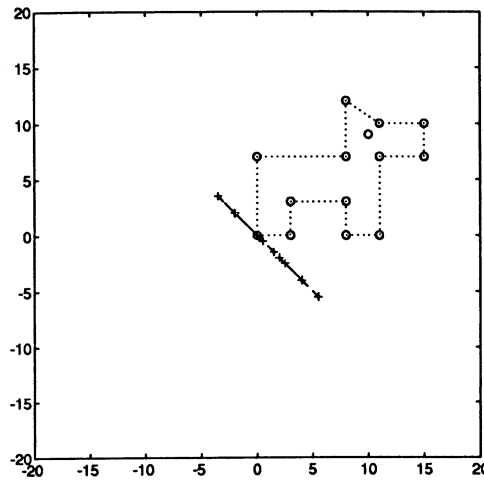
- (e) Repeat for your own figures.
4. (a) The diagonals of a rhombus with two sides \mathbf{x} and $F\mathbf{x}$ (the reflection of \mathbf{x} in the line through \mathbf{v}) will be perpendicular bisectors. Thus the diagonals meet at $\text{proj}_{\mathbf{v}} \mathbf{x}$, and from the bisection property, $2\text{proj}_{\mathbf{v}} \mathbf{x} = \mathbf{x} + F\mathbf{x}$. Since this is true for all \mathbf{x} , and since P is the matrix for the projection, $2P = I + F$ or $F = 2P - I$.
- (b)

```
>> v = [1 0]'; P = [ v(1)*v v(2)*v ] ; % Use the projection matrix from Problem 3
>> F = 2*P - eye(2)                    % Reflection matrix from results in (a)
F =
     1     0
     0    -1
>> graphics(pts,lns,'r','*',20,':')
>> hold on
>> graphics(F*pts,lns,'w','+',20,'--')
>> print -deps 'fig534b.eps'
```

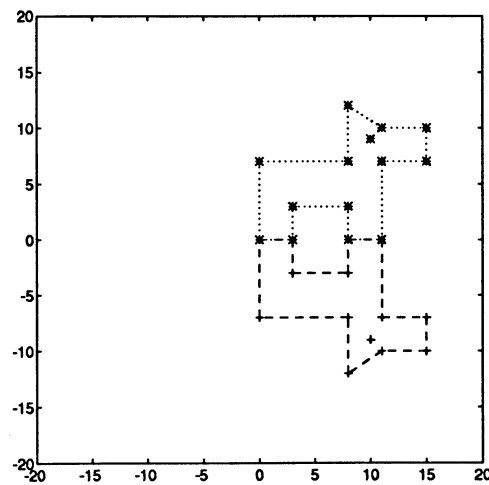

(c)

```

>> w = [-1 1]'; v = (1/norm(w))*w ;           % Form the unit vector along y = -x
>> P = [ v(1)*v v(2)*v ]; F = 2*P - eye(2) % Reflection in line through v
F =
    0.0000   -1.0000
   -1.0000    0.0000
>> graphics(pts,lns,'r','*',20,':')
>> hold on
>> graphics(F*pts,lns,'w','+',20,'--')
>> print -deps 'fig534c.eps'

```

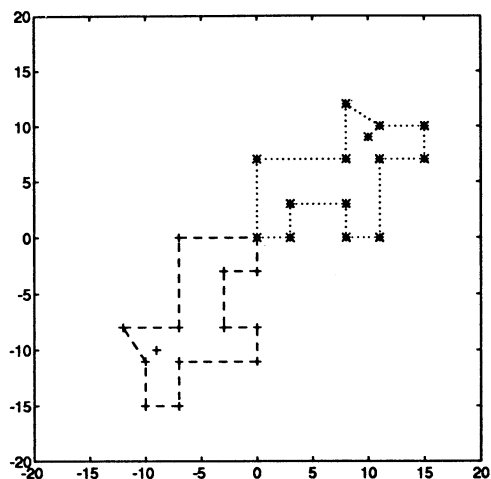

6. (a)

```

>> v1 = [1 0 3 -1]'; v2 = [2 -1 4 3]'; v3 = [3 2 0 -1]'; v4 = [ 4 2 1 1]';
>> rref([v1 v2 v3 v4]) % If this is I then vi's form a basis.
ans =
    1    0    0    0
    0    1    0    0
    0    0    1    0
    0    0    0    1

```

(b) We form various matrices from the given data:

```

>> Tv1 = [3 -1 7 2]'; Tv2 = [2 0 6 -2]'; Tv3 = [1 -1 1 4]'; Tv4 = [5 1 17 -10]';
>> V = [ v1 v2 v3 v4 ];
>> TV = [Tv1 Tv2 Tv3 Tv4];           % So T(c1*v1+...+c4*v4) = TV*[c1 ... c4]'
>> ce1 = V\[1 0 0 0]'; ce2 = V\[0 1 0 0]'; % cei are coordinates of ei with
>> ce3 = V\[0 0 1 0]'; ce4 = V\[0 0 0 1]'; %      respect to vi when ei = V*cei
>> Te1 = TV*ce1; Te2 = TV*ce2;           % T(ei) = T(V*cei) = TV*cei
>> Te3 = TV*ce3; Te4 = TV*ce4;
>> C = [ Te1 Te2 Te3 Te4 ]           % C = (T(e1) T(e2) T(e3) T(e4))
C =
   -6.0000   11.0000    4.0000    3.0000
   -2.8000    4.6000    1.2000    1.8000
  -23.6000   42.2000   14.4000   12.6000
   20.0000  -34.0000  -10.0000  -12.0000

```

(c) We'll rename some of the quantities from (b)

```
>> A = V ; B = TV ;
>> B/A - C % This should be all zeros, up to round off
ans =
1.0e-13 *
-0.0178  0.0355  0.0133  0.0089
-0.0089  0.0089  0.0067  0.0044
-0.1066  0.1421  0.0711  0.0178
0.0711 -0.1421 -0.0533 -0.0355
```

The comments in (b) help to explain why $C = BA^{-1}$ is the matrix for T . Specifically note the coordinates, ce_i of e_i with respect to the basis v_1, v_2, v_3, v_4 solve the equation $A*ce_i = e_i$, so $ce_i = A^{-1}e_i$. But $T(e_i) = B(ce_i)$ from the definition of T . Putting these together in the definition of C , $C = (T(e_1) T(e_2) T(e_3) T(e_4))$, yields $C = BA^{-1}$.

(d) We identify a basis for the kernel and the range of T from `rref(C)`.

```
>> r=rref(C)
r =
1.0000  0  1.6250 -1.8750
0  1.0000  1.2500 -0.7500
0  0  0  0
0  0  0  0
>> C(:,1:2)
ans =
-6.0000  11.0000
-2.8000  4.6000
-23.6000  42.2000
20.0000 -34.0000
```

Since there are pivots in columns 1 and 2 of r , $\{C(:, 1), C(:, 2)\}$ form a basis for Range C .

```
>> k1 = [-r(1,3) -r(2,3) 1 0] % Kernel of C from r*x = 0: First x3=1, x4=0
k1 =
-1.6250 -1.2500 1.0000 0
>> k2 = [-r(1,4) -r(2,4) 0 1] % Then x3=0, x4=1
k2 =
1.8750 0.7500 0 1.0000
```

Thus a basis of $\text{Ker } T$ is $\{k_1^t, k_2^t\}$.

7. Compute T as a product: $T = R(\pi/4) * Ey(3) * Ex(2) * R(-\pi/4)$, where $R(\theta)$ is rotation counterclockwise by θ , and $Ex(k)$, $Ey(k)$ are expansions in the x , respectively y , directions by the factor k . Note the order is correct since the right factor is performed first and the left factor is performed last.

(a)

```
>> Rpi4 = [ [ cos(pi/4); sin(pi/4) ] [ -sin(pi/4); cos(pi/4)]];
>> Ex2 = [ 2 0 ; 0 1 ] ; Ey3 = [ 1 0 ; 0 3] ;
>> T = Rpi4 * Ey3 * Ex2 * inv(Rpi4) % clockwise by pi/4 is the inverse of Rpi4.
T =
2.5000 -0.5000
-0.5000 2.5000
```

An alternative way to find the matrix for T would be to compute $T(e_1)$ in 4 steps via geometry, and similarly for $T(e_2)$

(b)

```
>> A = [ [1;1] [-1;1] ] ; % Form the transition matrix from basis B to Std.  
>> TB = inv(A)*T*A % T in basis B is: B to Std, then T, then Std to B. Theorem 5  
TB =  
    2    0  
    0    3
```

(c) TB shows that for vectors in the direction $(1, 1)^t$ T acts by expansion by a factor of 2, while for vectors in the direction $(-1, 1)^t$ T acts by expansion by a factor of 3. Since these two directions are independent, the action of T on any vector can be deduced by expanding it in each of the two new basis directions and performing the relevant expansions and adding the results back together.

Section 5.4

1. Since $(\alpha A)^t = \alpha A^t$ and $(A+B)^t = A^t+B^t$, T is linear. Also if $A^t = 0$ then $A = 0$. Hence $\ker T = \{0\}$. So T is 1-1. Since $\dim M_{mn} = \dim M_{nm}$, then by Theorem 2, T is onto. Thus T is an isomorphism.
2. A_T is invertible if and only if $\nu(A_T) = 0$. $\nu(A_T) = 0$ if and only if $\ker T = \{0\}$. $\ker T = \{0\}$ if and only if T is 1-1. Thus A_T is invertible if and only if T is 1-1. By Theorem 2, T is 1-1 if and only if T is onto. Therefore, A_T is invertible if and only if T is an isomorphism.
3. Suppose T is an isomorphism. Then $T\mathbf{x} = A_T(\mathbf{x})_{B_1} = \mathbf{0}$ if and only if $\mathbf{x} = \mathbf{0}$. Then $\det A_T \neq 0$. Conversely, suppose $\det A_T \neq 0$. Then $T\mathbf{x} = A_T(\mathbf{x})_{B_1} = \mathbf{0}$ has only the trivial solution. Then T is 1-1. Since $\dim V = \dim W = n$, T is also onto by Theorem 2. Thus T is an isomorphism.

4. Define $T : D_n \rightarrow \mathbb{R}^n$ by $T \begin{pmatrix} a_1 & 0 & \cdots & 0 \\ 0 & a_2 & \cdots & 0 \\ \vdots & \ddots & \ddots & \vdots \\ 0 & \cdots & a_n & \end{pmatrix} = \begin{pmatrix} a_1 \\ a_2 \\ \vdots \\ a_n \end{pmatrix}$, T is easily seen to be linear, 1-1 and onto. So

D_n, \mathbb{R}^n are isomorphic.

5. $\dim\{A : A \text{ is } n \times n \text{ and symmetric}\} = n(n+1)/2 = m$.
6. Let $V =$ the set of $n \times n$ symmetric matrices and let $W =$ the set of $n \times n$ upper triangular matrices. Note that $\dim V = \dim W = n(n+1)/2$. Define $T : V \rightarrow W$ by $T \begin{pmatrix} a_{11} & a_{12} & \cdots & a_{1n} \\ a_{12} & a_{22} & \cdots & a_{2n} \\ \vdots & \ddots & \ddots & \vdots \\ a_{1n} & \cdots & a_{nn} \end{pmatrix} =$

$$\begin{pmatrix} a_{11} & a_{12} & \cdots & a_{1n} \\ 0 & a_{22} & \cdots & a_{2n} \\ \vdots & \ddots & \ddots & \vdots \\ 0 & \cdots & a_{nn} \end{pmatrix}.$$

Clearly $\ker T = \{0\}$. Thus T is 1-1. Clearly T is also onto. Then T is an isomorphism and thus $V \simeq W$.

7. Define $T : V \rightarrow W$ by $Tp = xp$. Then $\ker T = \{0\}$ and thus T is 1-1. Since $\dim V = \dim W = 5$, T is also onto. Then $V \simeq W$.
8. Suppose $Tp = p + p' = 0$. Since p is a polynomial, $p + p' = 0$ implies that $p = 0$ (look at highest degree term). Then $\ker T = \{0\}$ and therefore T is 1-1. By Theorem 2, T is also onto. Then T is an isomorphism.
9. $mn = pq$, i.e. $\dim(M_{mn}) = \dim(M_{pq})$.

10. Define $T : D_n \rightarrow P_{n-1}$ by $T \begin{pmatrix} a_1 & 0 & \cdots & 0 \\ 0 & a_2 & \cdots & 0 \\ \vdots & \ddots & \ddots & \vdots \\ 0 & \cdots & a_n & \end{pmatrix} = a_1 + a_2x + \cdots + a_nx^{n-1}$. Clearly $\ker T = \{0\}$, so T is

1-1. Since $\dim D_n = \dim P_{n-1} = n$, T is also onto. Then $D_n \simeq P_{n-1}$.

11. Repeat the proof of Theorem 6 with the understanding that the scalars c_1, c_2, \dots, c_n are complex numbers.
12. Suppose $Tf = Tg$. Then $f(x-3) = g(x-3)$ for all $x \in [3, 4]$. That is, $f(x) = g(x)$ for all $x \in [0, 1]$. Then T is 1-1. If $f(x) \in C[3, 4]$ then $f(x+3) \in C[0, 1]$. Then $Tf(x+3) = f(x)$. So T is onto. Therefore, T is an isomorphism.
13. $T(A_1 + A_2) = (A_1 + A_2)B = A_1B + A_2B = TA_1 + TA_2$. $T(\alpha A) = \alpha AB = \alpha TA$. So T is linear. Suppose $TA = AB = O$. Then $A = OB^{-1} = O$. So $\ker T = \{O\}$ and therefore T is 1-1. Since $\dim M_{nm} = nm < \infty$, T is also onto by Theorem 2. Thus T is an isomorphism.

14. Suppose $Tp(x) = xp'(x) = 0$. Then $p'(x) = 0 \Rightarrow p(x) = \text{constant}$. Then $\ker T = \{p \in P_n : p(x) = c, c \in \mathbb{R}\}$. That is, $\ker T \neq \{0\}$. Then T is not 1-1 and therefore not an isomorphism.
15. If $\mathbf{h} \in H$ then $\text{proj}_H \mathbf{h} = \mathbf{h}$. So T is onto. If $H = V$ then T will be 1-1.
16. Let $\{\mathbf{v}_i\}$ be a basis in V . Then $\{T\mathbf{v}_i\}$ is a basis in W . Define $S : W \rightarrow V$ by $S(T\mathbf{v}_i) = \mathbf{v}_i$. Then $S(T\mathbf{v}) = \mathbf{v}$ for all $\mathbf{v} \in V$.
17. Problem 3 showed that A is invertible. We need $T^{-1}(T\mathbf{x}) = T^{-1}(A\mathbf{x}) = \mathbf{x}$. Then $T^{-1}\mathbf{x} = A^{-1}\mathbf{x}$ since $A^{-1}(A\mathbf{x}) = \mathbf{x}$.
18. $T^{-1}(p) = p(x)/x$, since any polynomial p with $p(0) = 0$ is divisible by x .
19. Define $T : \mathbb{C} \rightarrow \mathbb{R}^2$ by $T(a + ib) = (a, b)$. Let $z_1 = a_1 + ib_1$ and $z_2 = a_2 + ib_2$. Then

$$\begin{aligned} T(z_1 + z_2) &= T((a_1 + a_2) + i(b_1 + b_2)) \\ &= (a_1 + a_2, b_1 + b_2) \\ &= (a_1, b_1) + (a_2, b_2) \\ &= T(z_1) + T(z_2) \end{aligned}$$

If $\alpha \in \mathbb{R}$ then $T(\alpha z) = T(\alpha a + i\alpha b) = (\alpha a, \alpha b) = \alpha(a, b) = \alpha T(z)$. So T is linear. If $T(z) = (0, 0)$ then $z = 0 + i0 = 0$. So $\ker T = \{0\}$. Then T is 1-1. Since $\dim \mathbb{C} = \dim \mathbb{R}^2 = 2$, T is also onto. Therefore, $\mathbb{C} \simeq \mathbb{R}^2$.

20. Let $c_1 = a_1 + ib_1, \dots, c_n = a_n + ib_n$. Then let $T : \mathbb{C}_{\mathbb{R}}^n \rightarrow \mathbb{R}^{2n}$ be defined by $T(c_1, \dots, c_n) = (a_1, b_1, \dots, a_n, b_n)$. Let $d_1 = e_1 + if_1, \dots, d_n = e_n + if_n$. Then

$$\begin{aligned} T(c_1, \dots, c_n) + T(d_1, \dots, d_n) &= (a_1 + e_1, b_1 + f_1, \dots, a_n + e_n, b_n + f_n) \\ &= (a_1, b_1, \dots, a_n, b_n) + (e_1, f_1, \dots, e_n, f_n) \\ &= T(c_1, \dots, c_n) + T(d_1, \dots, d_n) \end{aligned}$$

If $\alpha \in \mathbb{R}$ then

$$\begin{aligned} T(\alpha c_1, \dots, \alpha c_n) &= (\alpha a_1, \alpha b_1, \dots, \alpha a_n, \alpha b_n) \\ &= \alpha(a_1, b_1, \dots, a_n, b_n) \\ &= \alpha T(c_1, \dots, c_n) \end{aligned}$$

So T is linear. $\ker T = \{0\}$, so T is 1-1. Since $\dim \mathbb{C}_{\mathbb{R}}^n = \dim \mathbb{R}^{2n} = 2n$, T is also onto. Therefore, $\mathbb{C}_{\mathbb{R}}^n \simeq \mathbb{R}^{2n}$.

MATLAB 5.4

1. T is to be defined by $T(\mathbf{v}_i) = \mathbf{w}_i$ where

```
>> v1 = [1 0 0 0]'; v2 = [2 1 0 0]'; v3 = [-2 1 2 0]'; v4 = [ 3 4 2 1]';
>> w1 = [1 2 1 0]'; w2 = [2 5 3 0]'; w3 = [-1 -1 -1 2]'; w4 = [ 0 3 7 7]';
```

(a)

```
>> rref([v1 v2 v3 v4]) % This will be I. So vi's form a basis. And T defined.
ans =
     1     0     0     0
     0     1     0     0
     0     0     1     0
     0     0     0     1
```

(b) We form various matrices from the given data:

```
>> rref([w1 w2 w3 w4]) % Since this too is I, wi's form a basis.
ans =
     1     0     0     0
     0     1     0     0
     0     0     1     0
     0     0     0     1
```

T will be an isomorphism. In fact $\rho(T) = 4$ (as the \mathbf{w}_i will form a basis for Range T) and $\nu(T) = 4 - \rho(T) = 0$. So T is onto \mathbb{R}^4 and 1-1, and thus an isomorphism.

(c) As in the solution to MATLAB 5.3.6, the matrix for T with respect to the standard basis can be found, efficiently, by:

```
>> V = [ v1 v2 v3 v4 ]; TV = [ w1 w2 w3 w4 ];
>> A = TV/V % This will be the matrix for T in the standard basis.
A =
     1.0000         0     0.5000    -4.0000
     2.0000     1.0000     1.0000    -9.0000
     1.0000     1.0000         0         0
         0         0     1.0000     5.0000
>> R = rref(A) % Use this to find bases for Range T and Ker T.
R =
     1     0     0     0
     0     1     0     0
     0     0     1     0
     0     0     0     1
```

Since $\text{rref}(A)$ is I , the columns of A (corresponding to the four pivots) form a basis for Range T and $\text{Ker } T = \{\mathbf{0}\}$. Thus $\text{Range } T = \mathbb{R}^4$. Hence T is 1-1 and onto, hence an isomorphism.

(d) If $S(\mathbf{w}_i) = \mathbf{v}_i$ then the matrix for S is

```
>> B = V/TV % TV=[ w1 w2 w3 w4 ] so reverse V, TV roles from (c)
B =
     1.8667    -0.8667     0.8667    -0.0667
    -1.8667     0.8667     0.1333     0.0667
    -0.6667     0.6667    -0.6667     0.6667
     0.1333    -0.1333     0.1333     0.0667
>> B*A % If I then B = inv(A)
ans =
     1.0000     0.0000     0.0000         0
     0.0000     1.0000     0.0000     0.0000
     0.0000         0     1.0000     0.0000
     0.0000     0.0000     0.0000     1.0000
```

Section 5.5

$$1. T\mathbf{x} \cdot T\mathbf{x} = \begin{pmatrix} x_1 \sin \theta + x_2 \cos \theta \\ x_1 \cos \theta - x_2 \sin \theta \\ x_3 \end{pmatrix} \cdot \begin{pmatrix} x_1 \sin \theta + x_2 \cos \theta \\ x_1 \cos \theta - x_2 \sin \theta \\ x_3 \end{pmatrix} = x_1^2 + x_2^2 + x_3^2 = \mathbf{x} \cdot \mathbf{x}, \text{ so } |T\mathbf{x}| = |\mathbf{x}|, \text{ or check}$$

$$A^t A = I.$$

$$2. T\mathbf{x} \cdot T\mathbf{x} = \begin{pmatrix} x_1 \cos \theta - x_2 \sin \theta \\ x_2 \\ x_1 \sin \theta + x_3 \cos \theta \end{pmatrix} \cdot \begin{pmatrix} x_1 \cos \theta - x_2 \sin \theta \\ x_2 \\ x_1 \sin \theta + x_3 \cos \theta \end{pmatrix} = x_1^2 + x_2^2 + x_3^2 = \mathbf{x} \cdot \mathbf{x}, \text{ and hence, } |T\mathbf{x}| = |\mathbf{x}|.$$

3. Using theorem 1, we have $T\mathbf{x} \cdot T\mathbf{x} = (A\mathbf{B}\mathbf{x}) \cdot (A\mathbf{B}\mathbf{x}) = \mathbf{x} \cdot [(A\mathbf{B})^t A\mathbf{B}\mathbf{x}] = \mathbf{x} \cdot (B^t A^t A\mathbf{B}\mathbf{x}) = \mathbf{x} \cdot \mathbf{x}$. Thus $|T\mathbf{x}| = |\mathbf{x}|$.

$$4. A_T = \begin{pmatrix} 1/\sqrt{2} & -1/\sqrt{6} & 1/\sqrt{3} \\ 1/\sqrt{2} & 1/\sqrt{6} & -1/\sqrt{3} \\ 0 & 2/\sqrt{6} & 1/\sqrt{3} \end{pmatrix}, \text{ with respect to the bases}$$

$$B_1 = \left\{ \begin{pmatrix} 2/3 \\ 1/3 \\ -2/3 \end{pmatrix}, \begin{pmatrix} 1/3 \\ 2/3 \\ 2/3 \end{pmatrix}, \begin{pmatrix} 2/3 \\ -2/3 \\ 1/3 \end{pmatrix} \right\} \text{ and } B_2 = \left\{ \begin{pmatrix} 1 \\ 0 \\ 0 \end{pmatrix}, \begin{pmatrix} 0 \\ 1 \\ 0 \end{pmatrix}, \begin{pmatrix} 0 \\ 0 \\ 1 \end{pmatrix} \right\}. \text{ As } A_T A_T^t = I, A_T \text{ is orthogonal.}$$

5. By theorem 2, isometries preserve inner products.

6. Assume \mathbf{x} and \mathbf{y} are nonzero. Let φ_1 denote the angle between \mathbf{x} and \mathbf{y} , and let φ_2 denote the angle between $T\mathbf{x}$ and $T\mathbf{y}$. By theorem 3.2.2, we have $\cos \varphi_1 = \frac{\mathbf{x} \cdot \mathbf{y}}{|\mathbf{x}||\mathbf{y}|}$ and $\cos \varphi_2 = \frac{T\mathbf{x} \cdot T\mathbf{y}}{|T\mathbf{x}||T\mathbf{y}|}$. Using theorem 2 and the definition of an isometry, we have $\cos \varphi_1 = \frac{T\mathbf{x} \cdot T\mathbf{y}}{|T\mathbf{x}||T\mathbf{y}|} = \frac{\mathbf{x} \cdot \mathbf{y}}{|\mathbf{x}||\mathbf{y}|} = \cos \varphi_2$. As $0 \leq \varphi_1, \varphi_2 \leq \pi$, it follows that $\varphi_1 = \varphi_2$.

7. Define $T\mathbf{x} = 2\mathbf{x}$. Then T preserves angles but is not an isometry.

8. As $\cos^{-1}[(\mathbf{x} \cdot \mathbf{y})/|\mathbf{x}||\mathbf{y}|] = \cos^{-1}[(T\mathbf{x} \cdot T\mathbf{y})/|T\mathbf{x}||T\mathbf{y}|]$, then T preserves angles.

9. As T is an isometry, A is orthogonal. Then $|S\mathbf{x}|^2 = |A^{-1}\mathbf{x}|^2 = (A^t\mathbf{x}) \cdot (A^t\mathbf{x}) = \mathbf{x} \cdot [(A^t)^t A^t\mathbf{x}] = \mathbf{x} \cdot (AA^t\mathbf{x}) = \mathbf{x} \cdot \mathbf{x} = |\mathbf{x}|^2$. Hence, $|S\mathbf{x}| = |\mathbf{x}|$.

10. For $P_1[-1, 1]$ we have $\left\{ 1/\sqrt{2}, \frac{\sqrt{6}}{2}x \right\}$ as an orthonormal basis (problem 4.11.7). Define $T(1/\sqrt{2}) = \begin{pmatrix} 1 \\ 0 \end{pmatrix}$ and $T\left(\frac{\sqrt{6}}{2}x\right) = \begin{pmatrix} 0 \\ 1 \end{pmatrix}$. So T is linear and $T(a + bx) = \begin{pmatrix} \sqrt{2}a \\ 2b/\sqrt{6} \end{pmatrix}$. As $\|T(a + bx)\|^2 = 2a^2 + 2b^2/3 = \int_{-1}^1 (a + bx)^2 dx = \|a + bx\|^2$, then T is an isometry.

11. We want an orthonormal basis for $P_3[-1, 1]$. Starting with the standard basis $\{1, x, x^2, x^3\}$ for $P_3[-1, 1]$, from problem 4.11.7 we have $\mathbf{u}_1 = 1/\sqrt{2}$, $\mathbf{u}_2 = \frac{\sqrt{6}}{2}x$, and $\mathbf{u}_3 = \frac{\sqrt{10}}{4}(3x^2 - 1)$. To find \mathbf{u}_4 , we compute $(\mathbf{v}_4, \mathbf{u}_1) = \int_{-1}^1 x^3/\sqrt{2} dx = 0$, $(\mathbf{v}_4, \mathbf{u}_2) = \int_{-1}^1 x^3 \left(\frac{\sqrt{6}}{2}x\right) dx = \frac{\sqrt{6}}{5}$, and $(\mathbf{v}_4, \mathbf{u}_3) = \int_{-1}^1 x^3 \left[\frac{3\sqrt{10}}{4} \left(x^2 - \frac{1}{3}\right)\right] dx = 0$. So $\mathbf{v}'_4 = \mathbf{v}_4 - (\mathbf{v}_4, \mathbf{u}_2)\mathbf{u}_2 = x^3 - \frac{3}{5}x$, and $|\mathbf{v}'_4| = 2\sqrt{2}/5\sqrt{7}$. Thus $\mathbf{u}_4 = \frac{\sqrt{7}}{2\sqrt{2}}(5x^3 - 3x)$. Let $\{\mathbf{e}_1, \mathbf{e}_2, \mathbf{e}_3, \mathbf{e}_4\}$ denote the standard basis for \mathbb{R}^4 . Define $T\mathbf{u}_i = \mathbf{e}_i$

for each i . Then $T(a_2x^2) = a_2T\left(\frac{4}{3\sqrt{10}}\mathbf{u}_3 + \frac{\sqrt{2}}{3}\mathbf{u}_1\right) = a_2\left(\frac{4}{3\sqrt{10}}\mathbf{e}_3 + \frac{\sqrt{2}}{3}\mathbf{e}_1\right)$, and $T(a_3x^3) = a_3T\left(\frac{2\sqrt{2}}{5\sqrt{7}}\mathbf{u}_4 + \frac{\sqrt{6}}{5}\mathbf{u}_2\right) = a_3\left(\frac{2\sqrt{2}}{5\sqrt{7}}\mathbf{e}_4 + \frac{\sqrt{6}}{5}\mathbf{e}_2\right)$. Hence, $T(a_0 + a_1x + a_2x^2 + a_3x^3) = \left(\sqrt{2}a_0 + \frac{\sqrt{2}}{3}a_2, \frac{2}{\sqrt{6}}a_1 + \frac{\sqrt{6}}{5}a_3, \frac{4}{3\sqrt{10}}a_2, \frac{2\sqrt{2}}{5\sqrt{7}}a_3\right)$. Check that $\|T(a_0 + a_1x + a_2x^2 + a_3x^3)\|^2 = 2a_0^2 + \frac{4}{3}a_0a_2 + \frac{2}{3}a_1^2 + \frac{2}{5}a_2^2 + \frac{4}{5}a_1a_3 + \frac{2}{7}a_3^2 = \|a_0 + a_1x + a_2x^2 + a_3x^3\|^2$. Thus, T is an isometry.

12. Recall that M_{22} is an inner product space with $(A, B) = \text{tr}(AB^t)$. We have $\{\mathbf{u}_1, \mathbf{u}_2, \mathbf{u}_3, \mathbf{u}_4\} = \left\{\begin{pmatrix} 1 & 0 \\ 0 & 0 \end{pmatrix}, \begin{pmatrix} 0 & 1 \\ 0 & 0 \end{pmatrix}, \begin{pmatrix} 0 & 0 \\ 1 & 0 \end{pmatrix}, \begin{pmatrix} 0 & 0 \\ 0 & 1 \end{pmatrix}\right\}$ for an orthonormal basis of M_{22} . Define $T\mathbf{u}_i = \mathbf{e}_i$ for each

i . Then $T\begin{pmatrix} a & b \\ c & d \end{pmatrix} = \begin{pmatrix} a \\ b \\ c \\ d \end{pmatrix}$ and $\left\|T\begin{pmatrix} a & b \\ c & d \end{pmatrix}\right\|^2 = a^2 + b^2 + c^2 + d^2 = \left\|\begin{pmatrix} a & b \\ c & d \end{pmatrix}\right\|^2$. Thus T is an isometry.

13. We have $\{\mathbf{u}_1, \mathbf{u}_2, \mathbf{u}_3, \mathbf{u}_4\} = \left\{\begin{pmatrix} 1 & 0 \\ 0 & 0 \end{pmatrix}, \begin{pmatrix} 0 & 1 \\ 0 & 0 \end{pmatrix}, \begin{pmatrix} 0 & 0 \\ 1 & 0 \end{pmatrix}, \begin{pmatrix} 0 & 0 \\ 0 & 1 \end{pmatrix}\right\}$ for an orthonormal basis of M_{22} , and $\{\mathbf{v}_1, \mathbf{v}_2, \mathbf{v}_3, \mathbf{v}_4\} = \left\{1/\sqrt{2}, \frac{\sqrt{6}}{2}x, \frac{\sqrt{10}}{4}(3x^2 - 1), \frac{\sqrt{7}}{2\sqrt{2}}(5x^3 - 3x)\right\}$ for an orthonormal basis of $P_3[-1, 1]$.

Define $T\mathbf{u}_i = \mathbf{v}_i$ for each i . Then $T\begin{pmatrix} a & b \\ c & d \end{pmatrix} = a/\sqrt{2} + \frac{\sqrt{6}}{2}bx + \frac{\sqrt{10}}{4}c(3x^2 - 1) + \frac{\sqrt{7}}{2\sqrt{2}}d(5x^3 - 3x)$ and $\left\|T\begin{pmatrix} a & b \\ c & d \end{pmatrix}\right\|^2 = a^2 + b^2 + c^2 + d^2 = \left\|\begin{pmatrix} a & b \\ c & d \end{pmatrix}\right\|^2$. Hence T is an isometry.

14. Recall that D_n is an inner product space with $(A, B) = \text{tr}(AB)$. Let E_i denote the $n \times n$ matrix with 1 in i, i position and 0 everywhere else. Then the set $\{E_i : i = 1, 2, \dots, n\}$ is an orthonormal

basis for D_n . Define $TE_i = \mathbf{e}_i, i = 1, 2, \dots, n$. So $TA = T\begin{pmatrix} a_{11} & 0 & 0 & \cdots & 0 \\ 0 & a_{22} & 0 & \cdots & 0 \\ 0 & 0 & a_{33} & \cdots & 0 \\ \vdots & \vdots & \vdots & \ddots & \vdots \\ 0 & 0 & 0 & \cdots & a_{nn} \end{pmatrix} = \begin{pmatrix} a_{11} \\ a_{22} \\ a_{33} \\ \vdots \\ a_{nn} \end{pmatrix}$. As

$$\|TA\|^2 = \sum_{i=1}^n a_{ii}^2 = \|A\|^2, T \text{ is an isometry.}$$

15. $A^* = \begin{pmatrix} 1-i & 3 \\ -4-2i & 6+3i \end{pmatrix}$ 16. $A^* = \begin{pmatrix} 4 & 3-2i \\ 3+2i & 6 \end{pmatrix} = A$

17. As $A^* = A$, then $a_{ii} = \overline{a_{ii}}$, and hence, a_{ii} is real.

18. $AA^* = \begin{pmatrix} (1+i)/2 & (3-2i)/\sqrt{26} \\ (1+i)/2 & (-3+2i)/\sqrt{26} \end{pmatrix} \begin{pmatrix} (1-i)/2 & (1-i)/2 \\ (3+2i)/\sqrt{26} & (-3-2i)/\sqrt{26} \end{pmatrix} = \begin{pmatrix} 1 & 0 \\ 0 & 1 \end{pmatrix}$

19. Let \mathbf{c}_i denote the i^{th} column of A , and let $A^*A = (b_{ij})$. Note that $b_{ij} = \sum_{k=1}^n \overline{a_{ki}}a_{kj} = \overline{\mathbf{c}_i} \cdot \mathbf{c}_j$. If A is

unitary, then $b_{ij} = \begin{cases} 1, & \text{if } i = j \\ 0, & \text{if } i \neq j \end{cases}$, which means the columns of A form an orthonormal basis for \mathbb{C}^n .

Conversely, if the columns form an orthonormal basis, then $b_{ij} = \begin{cases} 1, & \text{if } i = j \\ 0, & \text{if } i \neq j \end{cases}$, and A is unitary.

20. Note that $\det(\bar{A}) = \overline{\det(A)}$. Hence, $|\det(AA^*)| = |\det(A)\det(A^*)| = |\det(A)||\det(A^*)| = |\det(A)||\det(\bar{A}^t)| = |\det(A)||\det(A^t)| = |\det(A)|^2 = |\det(I)| = 1$. Thus $|\det(A)| = 1$.

21. As $A^* = (\bar{a}_{ji})$, then the i^{th} component of $A^*\mathbf{y}$ is $\sum_{j=1}^n \bar{a}_{ji}y_j$. Thus, $(\mathbf{x}, A^*\mathbf{y}) = \sum_{i=1}^n x_i \left(\sum_{j=1}^n \bar{a}_{ji}y_j \right) = \sum_{i=1}^n \sum_{j=1}^n x_i a_{ji} \bar{y}_j = \sum_{j=1}^n \bar{y}_j \sum_{i=1}^n a_{ji} x_i = (A\mathbf{x}, \mathbf{y})$.

22. Let $\{\mathbf{u}_1, \mathbf{u}_2, \dots, \mathbf{u}_n\}$ and $\{\mathbf{w}_1, \mathbf{w}_2, \dots, \mathbf{w}_n\}$ be orthonormal bases for V and W , respectively. Define $T\mathbf{u}_i = \mathbf{w}_i$ for each i . Note that T is an isomorphism, since T is onto. We want to show that T is an isometry. Let $\mathbf{v} \in V$, and $\mathbf{v} = \sum_{i=1}^n c_i \mathbf{u}_i$. Then $\|T\mathbf{v}\|^2 = (T\mathbf{v}, T\mathbf{v}) = \left(\sum_{i=1}^n c_i T\mathbf{u}_i, \sum_{i=1}^n c_i T\mathbf{u}_i \right) = \left(\sum_{i=1}^n c_i \mathbf{w}_i, \sum_{i=1}^n c_i \mathbf{w}_i \right) = \sum_{i=1}^n c_i \bar{c}_i$, since the \mathbf{w}_i are orthonormal. But $\|\mathbf{v}\|^2 = (\mathbf{v}, \mathbf{v}) = \left(\sum_{i=1}^n c_i \mathbf{u}_i, \sum_{i=1}^n c_i \mathbf{u}_i \right) = \sum_{i=1}^n c_i \bar{c}_i$, since the \mathbf{u}_i are orthonormal. Hence $\|T\mathbf{v}\| = \|\mathbf{v}\|$. As T is an isometry, the proof is complete.

MATLAB 5.5

1. (a) Rotation and reflection are linear transformations since they map parallelograms to parallelograms and preserve multiples. They are isometries since they preserve lengths.

(b)

```
>> Rpi3 = [ [cos(pi/3); sin(pi/3)] [-sin(pi/3); cos(pi/3)] ] % Rotation by pi/3.
Rpi3 =
    0.5000   -0.8660
    0.8660    0.5000
>> Rpi3'*Rpi3 % Since this product is I, the rotation matrix is orthogonal
ans =
     1     0
     0     1
>> w = 2*rand(2,1)-1; v = (1/norm(w))*w % A random unit vector
v =
   -0.5272
   -0.8497
>> F = 2*[v(1)*v v(2)*v]-eye(2) % Reflection matrix is 2*proj-I
F =
   -0.4441    0.8960
    0.8960    0.4441
>> F'*F % Gives I and shows reflection matrix F is orthogonal
ans =
    1.0000    0.0000
    0.0000    1.0000
```

- (c) Rotation by θ is $R(\theta) = \begin{pmatrix} \cos(\theta) & -\sin(\theta) \\ \sin(\theta) & \cos(\theta) \end{pmatrix}$. Thus

$$R(\theta)^t R(\theta) = \begin{pmatrix} \cos^2(\theta) + \sin^2(\theta) & \cos(\theta)(-\sin(\theta)) + \sin(\theta)\cos(\theta) \\ (-\sin(\theta))\cos(\theta) + \cos(\theta)\sin(\theta) & (-\sin(\theta))^2 + \cos^2(\theta) \end{pmatrix} = \begin{pmatrix} 1 & 0 \\ 0 & 1 \end{pmatrix}$$

so rotation is orthogonal. For reflection note that in MATLAB 5.3.3 the matrix for projection onto the line through the unit vector \mathbf{v} is shown to be $P = (v_1\mathbf{v} \ v_2\mathbf{v}) = \begin{pmatrix} v_1^2 & v_1v_2 \\ v_1v_2 & v_2^2 \end{pmatrix}$. Note

this formula shows $P^t = P$. Also, $P^2 = P$ since projecting a vector which already lies along \mathbf{v} leaves it unchanged. (We could have computed this fact using $v_1^2 + v_2^2 = 1$.) But then $F^t F = (2P^t - I)(2P - I) = (2P - I)(2P - I) = 4P^2 - 4P + I = 4P - 4P + I = I$, which shows F is orthogonal.

- (d) In (b) above we found a random \mathbf{v} and F , the reflection in the line through \mathbf{v} . We will use those matrices here.

```
>> alpha = atan(v(2)/v(1)) % Angle for v
alpha =
    1.0155
>> R = [ [cos(2*alpha); sin(2*alpha)] [-sin(2*alpha); cos(2*alpha)] ];
>> X = [ 1 0 ; 0 -1 ] ; % Reflection in x-axis takes y to -y
>> R*X % This gives same matrix as F
ans =
   -0.4441    0.8960
    0.8960    0.4441
```

- (e) If $\mathbf{v} = (\cos(\alpha) \sin(\alpha))^t$ then $F = 2P - I = \begin{pmatrix} 2\cos^2(\alpha) - 1 & 2\sin(\alpha)\cos(\alpha) \\ 2\cos(\alpha)\sin(\alpha) & 2\sin^2(\alpha) - 1 \end{pmatrix} = \begin{pmatrix} \cos(2\alpha) & \sin(2\alpha) \\ \sin(2\alpha) & -\cos(2\alpha) \end{pmatrix}$.

This is exactly RX , i.e. R with its second column negated.

2. T is to be defined by $T(\mathbf{v}_i) = \mathbf{w}_i$ where

```
>> v1 = [2/3 1/3 -2/3]'; v2 = [1/3 2/3 2/3]'; v3 = [2/3 -2/3 1/3]';
>> w1 = [1/sqrt(2) 1/sqrt(2) 0]'; w2 = [-1 1 2]'/sqrt(6); w3 = [1 -1 1]'/sqrt(3);
```

As in the solution to MATLAB 5.3.6, the matrix for T with respect to the standard basis can be found, efficiently, by:

```
>> V = [ v1 v2 v3 ]; W = [ w1 w2 w3 ];
>> A = W/V          % This will be the matrix for T in the standard basis.
A =
    0.7202   -0.4214   -0.5511
    0.2226    0.8928   -0.3917
    0.6571    0.1594    0.7368
>> A'*A          % Test for orthogonality. If I then A is orthogonal
ans =
    1.0000    0.0000    0.0000
    0.0000    1.0000    0.0000
    0.0000    0.0000    1.0000
```

Now to verify that T maps an orthonormal basis to an orthonormal basis, we just check that the \mathbf{v}_i and \mathbf{w}_i both form orthonormal bases:

```
>> V'*V          % This is I, showing the vi form an orthonormal basis
ans =
     1     0     0
     0     1     0
     0     0     1
>> W'*W          % This is I, and shows the wi form an orthonormal basis
ans =
    1.0000         0         0
         0    1.0000         0
         0         0    1.0000
```

Any isometry preserves lengths, by definition. Hence it will map sets of unit vectors to sets of unit vectors. But it also preserves inner products, by Theorem 6 and hence preserves orthogonality. Thus it will map orthonormal bases to orthonormal bases.

Review Exercises for Chapter 5

1. $T(x_1, y_1) + T(x_2, y_2) = (0, -y_1) + (0, -y_2) = (0, -(y_1 + y_2)) = T((x_1, y_1) + (x_2, y_2))$
 $T(\alpha(x, y)) = (0, -\alpha y) = \alpha(0, -y) = \alpha T(x, y)$.
 Therefore T is a linear transformation.

2.

$$\begin{aligned} T(x_1, y_1, z_1) + T(x_2, y_2, z_2) &= (1, y_1, z_1) + (1, y_2, z_2) \\ &= (2, (y_1 + y_2), (z_1 + z_2)) \\ &\neq (1, (y_1 + y_2), (z_1 + z_2)) \\ &= T((x_1, y_1, z_1) + (x_2, y_2, z_2)) \end{aligned}$$

Therefore T is not a linear transformation.

3. $\frac{x_1}{y_1} + \frac{x_2}{y_2}$ does not necessarily equal $\frac{x_1 + x_2}{y_1 + y_2}$. Therefore T is not a linear transformation.

4.

$$\begin{aligned} T(a + bx) + T(c + dx) &= (ax + bx^2) + (cx + dx^2) \\ &= (a + c)x + (b + d)x^2 = T((a + bx) + (c + dx)) \end{aligned}$$

$T(\alpha(a + bx)) = \alpha(ax + bx^2) = \alpha T(a + bx)$. Therefore T is a linear transformation.

5.

$$\begin{aligned} T(p_1) + T(p_2) &= (1 + p_1) + (1 + p_2) \\ &= 2 + p_1 + p_2 \neq 1 + (p_1 + p_2) = T(p_1 + p_2) \end{aligned}$$

Therefore T is not a linear transformation.

6. $T(f_1) + T(f_2) = f_1(1) + f_2(1) = (f_1 + f_2)(1) = T(f_1 + f_2)$
 $T(\alpha f) = \alpha f(1) = T(f)$; therefore T is a linear transformation.

7. Since $\begin{vmatrix} 2 & -1 \\ 4 & 7 \end{vmatrix} \neq 0$, $\text{Ker } T = \{(0, 0)\}$; $\nu(T) = 0$; $\text{Range } T = \mathbb{R}^2$; $\rho(T) = 2$.

8. $\begin{pmatrix} 1 & 2 & -1 \\ 2 & 4 & 3 \\ 1 & 2 & -6 \end{pmatrix} \rightarrow \begin{pmatrix} 1 & 2 & -1 \\ 0 & 0 & 5 \\ 0 & 0 & 5 \end{pmatrix} \rightarrow \begin{pmatrix} 1 & 2 & 0 \\ 0 & 0 & 1 \\ 0 & 0 & 0 \end{pmatrix}$; $\text{Ker } T = \{(x, y, z) : z = 0 \text{ and } x = -2y\}$; $\nu(T) = 1$. Note that $3R_1 - R_2 - R_3 = (0, 0, 0)$. Then $\text{Range } T = \{(x, y, z) : z = 3x - y\}$; $\rho(T) = 2$. Or choose pivot columns in A_T : $\text{Range } T = \text{span} \left\{ \begin{pmatrix} 1 \\ 2 \\ 1 \end{pmatrix}, \begin{pmatrix} -1 \\ 3 \\ -6 \end{pmatrix} \right\}$.

9. $\text{Ker } T = \{(x, y, z) : x = 0 \text{ and } y = 0\}$; $\nu(T) = 1$; $\text{Range } T = \mathbb{R}^2$; $\rho(T) = 2$.

10. $\text{Ker } T = \{0\}$; $\nu(T) = 0$; $\text{Range } T = \{a + bx + cx^2 + dx^3 + ex^4 : a = 0 \text{ and } b = 0\}$; $\rho(T) = 3$.

11. Let $A = \begin{pmatrix} x & y \\ z & w \end{pmatrix}$. Then $AB = \begin{pmatrix} x - y & x + y \\ z - w & z + w \end{pmatrix}$. $\text{Ker } T = \left\{ \begin{pmatrix} 0 & 0 \\ 0 & 0 \end{pmatrix} \right\}$; $\nu(T) = 0$; $\text{Range } T = M_{22}$; $\rho(T) = 4$.

12. $\text{Ker } T = \{f \in C[0, 1] : f(1) = 0\}$; $\text{Ker } T$ is infinite dimensional; $\text{Range } T = \mathbb{R}$; $\rho(T) = 1$.

13. $A_T = \begin{pmatrix} 0 & 0 \\ 0 & -1 \end{pmatrix}$; $\text{Ker } T = \text{span} \left\{ \begin{pmatrix} 1 \\ 0 \end{pmatrix} \right\}$; $\nu(T) = 1$, $\text{Range } T = \text{span} \left\{ \begin{pmatrix} 0 \\ -1 \end{pmatrix} \right\}$; $\rho(T) = 1$.

$$14. A_T = \begin{pmatrix} 0 & 1 & 0 \\ 0 & 0 & 1 \end{pmatrix}; \text{Ker } T = \text{span} \left\{ \begin{pmatrix} 1 \\ 0 \\ 0 \end{pmatrix} \right\}; \nu(T) = 1; \text{Range } T = \mathbb{R}^2; \rho(T) = 2.$$

$$15. A_T = \begin{pmatrix} 1 & 0 & -2 & 0 \\ 0 & 2 & 0 & 3 \end{pmatrix}; \text{Ker } T = \text{span} \left\{ \begin{pmatrix} 2 \\ 0 \\ 1 \\ 0 \end{pmatrix}, \begin{pmatrix} 0 \\ -3 \\ 0 \\ 2 \end{pmatrix} \right\}; \text{Range } T = \mathbb{R}^2; \rho(T) = 2; \nu(T) = 2.$$

$$16. A_T = \begin{pmatrix} 0 & 0 & 0 & 0 \\ 1 & 0 & 0 & 0 \\ 0 & 1 & 0 & 0 \\ 0 & 0 & 1 & 0 \\ 0 & 0 & 0 & 1 \end{pmatrix}; \text{Ker } T = \{0\}; \nu(T) = 0; \text{Range } T = \text{span} \{x, x^2, x^3, x^4\}; \rho(T) = 4; \nu(T) = 0.$$

$$17. A_T = \begin{pmatrix} -1 & 1 & 0 & 0 \\ 0 & 2 & 0 & 0 \\ 0 & 0 & -1 & 1 \\ 0 & 0 & 0 & 2 \end{pmatrix}; \text{Ker } T = \{0\}; \nu(T) = 0; \text{Range } T = M_{22}; \rho(T) = 4; \nu(T) = 0.$$

$$18. T(1, 1) = (0, 5); T(1, 2) = (-1, 8); (0, 5)_{B_2} = (20/13, 5/13); (-1, 8)_{B_2} = (33/13, 5/13); A_T = \frac{1}{13} \begin{pmatrix} 20 & 5 \\ 33 & 5 \end{pmatrix}; \text{Ker } T = \{0\}; \nu(T) = 0; (\text{Range } T)_{B_2} = \text{span} \left\{ \begin{pmatrix} 20/13 \\ 5/13 \end{pmatrix}, \begin{pmatrix} 33/13 \\ 5/13 \end{pmatrix} \right\}, \rho(T) = 2.$$

19. Expansion along the x -axis with $c = 3$.

21. Shear along the y -axis with $c = -2$.

$$23. \begin{pmatrix} 3 & 0 \\ 0 & 1 \end{pmatrix}$$

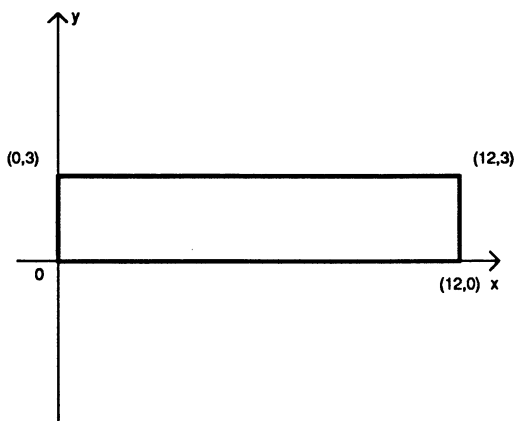

20. Compression along the y -axis with $c = 1/3$.

22. Shear along the x -axis with $c = -5$.

$$24. \begin{pmatrix} 1 & 0 \\ 0 & 1/3 \end{pmatrix}$$

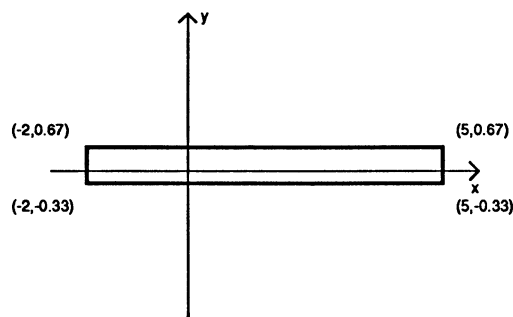

$$25. \begin{pmatrix} 0 & 1 \\ 1 & 0 \end{pmatrix}$$

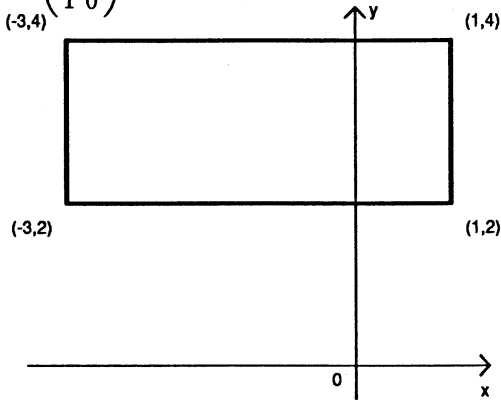

$$26. \begin{pmatrix} 1 & -3 \\ 0 & 1 \end{pmatrix}$$

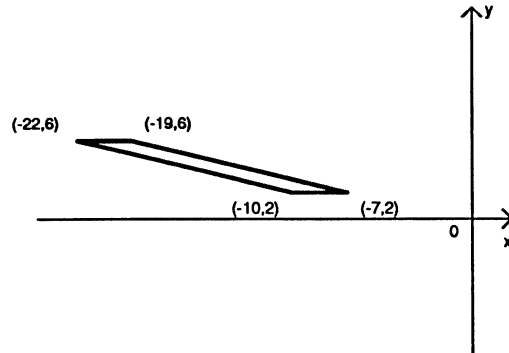

27. The row operations to transform to the identity matrix are:

1. $R_2 + 2R_1$; 2. $R_2/8$; 3. $R_1 - 3R_2$

$$\begin{pmatrix} 1 & 3 \\ -2 & 2 \end{pmatrix} = \begin{pmatrix} 1 & 0 \\ -2 & 1 \end{pmatrix} \begin{pmatrix} 1 & 0 \\ 0 & 8 \end{pmatrix} \begin{pmatrix} 1 & 3 \\ 0 & 1 \end{pmatrix}$$

28. The row operations to transform to the identity matrix are:

1. $R_1 \leftrightarrow R_2$; 2. $-R_1/3$; 3. $R_2/5$; 4. $R_1 + 2R_2/3$

$$\begin{pmatrix} 0 & 5 \\ -3 & 2 \end{pmatrix} = \begin{pmatrix} 0 & 1 \\ 1 & 0 \end{pmatrix} \begin{pmatrix} -3 & 0 \\ 0 & 1 \end{pmatrix} \begin{pmatrix} 1 & 0 \\ 0 & 5 \end{pmatrix} \begin{pmatrix} 1 & -2/3 \\ 0 & 1 \end{pmatrix}$$

29. The row operations to transform to the identity matrix are:

1. $R_1 \leftrightarrow R_2$; 2. $R_2 + 6R_1$; 3. $R_2/22$; 4. $R_1 - 3R_2$

$$\begin{pmatrix} -6 & 4 \\ 1 & 3 \end{pmatrix} = \begin{pmatrix} 0 & 1 \\ 1 & 0 \end{pmatrix} \begin{pmatrix} 1 & 0 \\ -6 & 1 \end{pmatrix} \begin{pmatrix} 1 & 0 \\ 0 & 22 \end{pmatrix} \begin{pmatrix} 1 & 3 \\ 0 & 1 \end{pmatrix}$$

30. The row operations to transform to the identity matrix are:

1. $R_1 \leftrightarrow R_2$; 2. $R_2 - 2R_1$; 3. $-R_2/9$; 4. $R_1 - 5R_2$

$$\begin{pmatrix} 2 & 1 \\ 1 & 5 \end{pmatrix} = \begin{pmatrix} 0 & 1 \\ 1 & 0 \end{pmatrix} \begin{pmatrix} 1 & 0 \\ 2 & 1 \end{pmatrix} \begin{pmatrix} 1 & 0 \\ 0 & -9 \end{pmatrix} \begin{pmatrix} 1 & 5 \\ 0 & 1 \end{pmatrix}$$

$$31. T(a_0 + a_1x + a_2x^2) = \begin{pmatrix} a_0 \\ a_1 \\ a_2 \end{pmatrix}$$

32. Use the standard basis $\left\{ \begin{pmatrix} 1 \\ 0 \end{pmatrix}, \begin{pmatrix} 0 \\ 1 \end{pmatrix} \right\}$ of \mathbb{R}^2 and the orthonormal basis $\{1/\sqrt{2}, \sqrt{3}/2 \cdot x\}$ of $P_1[-1, 1]$.

Let $T \begin{pmatrix} 1 \\ 0 \end{pmatrix} = 1/\sqrt{2}$ and $T \begin{pmatrix} 0 \\ 1 \end{pmatrix} = \sqrt{3}/2 \cdot x$. Then $T \begin{pmatrix} a \\ b \end{pmatrix} = a/\sqrt{2} + \sqrt{3}/2 \cdot bx$. Let $\mathbf{x} = \begin{pmatrix} a_1 \\ b_1 \end{pmatrix}$ and

$\mathbf{y} = \begin{pmatrix} a_2 \\ b_2 \end{pmatrix}$. Then $(\mathbf{x}, \mathbf{y}) = a_1a_2 + b_1b_2$. $(T\mathbf{x}, T\mathbf{y}) = \int_{-1}^1 (a_1a_2/2 + (a_1b_2 + a_2b_1)x \cdot \sqrt{3}/2 + 3b_1b_2x^2/2) dx = a_1a_2 + b_1b_2$. Thus T is an isometry.

Chapter 6. Eigenvalues, Eigenvectors and Canonical Forms

Section 6.1

$$1. \begin{vmatrix} -2-\lambda & -2 \\ -5 & 1-\lambda \end{vmatrix} = \lambda^2 + \lambda - 12 = (\lambda + 4)(\lambda - 3); \text{ Eigenvalues: } -4, 3$$

$$A + 4I = \begin{pmatrix} 2 & -2 \\ -5 & 5 \end{pmatrix} \Rightarrow E_{-4} = \text{span} \left\{ \begin{pmatrix} 1 \\ 1 \end{pmatrix} \right\}$$

$$A - 3I = \begin{pmatrix} -5 & -2 \\ -5 & -2 \end{pmatrix} \Rightarrow E_3 = \text{span} \left\{ \begin{pmatrix} -2 \\ 5 \end{pmatrix} \right\}$$

$$2. \begin{vmatrix} -12-\lambda & 7 \\ -7 & 2-\lambda \end{vmatrix} = \lambda^2 + 10\lambda + 25 = (\lambda + 5)^2; \text{ Eigenvalues: } -5, -5$$

$$A + 5I = \begin{pmatrix} -7 & 7 \\ -7 & 7 \end{pmatrix} \Rightarrow E_{-5} = \text{span} \left\{ \begin{pmatrix} 1 \\ 1 \end{pmatrix} \right\}; \text{ Geometric multiplicity of } -5 \text{ is } 1.$$

$$3. \begin{vmatrix} 2-\lambda & -1 \\ 5 & -2-\lambda \end{vmatrix} = \lambda^2 + 1; \text{ Eigenvalues: } i, -i.$$

$$A - iI = \begin{pmatrix} 2-i & -1 \\ 5 & -2-i \end{pmatrix} \Rightarrow E_i = \text{span} \left\{ \begin{pmatrix} 2+i \\ 5 \end{pmatrix} \right\} = \text{span} \left\{ \begin{pmatrix} 1 \\ 2-i \end{pmatrix} \right\}. \text{ Then taking conjugates,}$$

$$E_{-i} = \text{span} \left\{ \begin{pmatrix} 2-i \\ 5 \end{pmatrix} \right\}.$$

$$4. \begin{vmatrix} -3-\lambda & 0 \\ 0 & -3-\lambda \end{vmatrix} = (-3-\lambda)^2; \text{ Eigenvalues: } -3, -3$$

$$A + 3I = \begin{pmatrix} 0 & 0 \\ 0 & 0 \end{pmatrix} \Rightarrow E_{-3} = \mathbb{R}^2. \text{ Geometric multiplicity of } -3 \text{ is } 2.$$

$$5. \begin{vmatrix} -3-\lambda & 2 \\ 0 & -3-\lambda \end{vmatrix} = (-3-\lambda)^2; \text{ Eigenvalues: } -3, -3$$

$$A + 3I = \begin{pmatrix} 0 & 2 \\ 0 & 0 \end{pmatrix} \Rightarrow E_{-3} = \text{span} \left\{ \begin{pmatrix} 1 \\ 0 \end{pmatrix} \right\}; \text{ Geometric multiplicity of } -3 \text{ is } 1.$$

$$6. \begin{vmatrix} 3-\lambda & 2 \\ -5 & 1-\lambda \end{vmatrix} = \lambda^2 - 4\lambda + 13; \text{ Eigenvalues: } 2 + 3i, 2 - 3i.$$

$$A - (2 + 3i)I = \begin{pmatrix} 1-3i & 2 \\ -5 & -1-3i \end{pmatrix} \Rightarrow E_{2+3i} = \text{span} \left\{ \begin{pmatrix} 1+3i \\ -5 \end{pmatrix} \right\} = \text{span} \left\{ \begin{pmatrix} 1 \\ (3i-1)/2 \end{pmatrix} \right\}.$$

$$\text{Then } E_{2-3i} = \text{span} \left\{ \begin{pmatrix} 1-3i \\ -5 \end{pmatrix} \right\}, \text{ taking conjugates.}$$

In 7-20, to find one root of $P(\lambda)$, try division by $(\lambda - r)$ with $\pm r$ a factor of the constant term. Once division yields one root repeat with the quotient. Also see MATLAB 6.1.3 solutions for 6.1.8 for an illustration of how to use row operations to get a factored form of the characteristic polynomial.

$$7. \begin{vmatrix} 1-\lambda & -1 & 0 \\ -1 & 2-\lambda & -1 \\ 0 & -1 & 1-\lambda \end{vmatrix} = \lambda(1-\lambda)(\lambda-3); \text{ Eigenvalues: } 0, 1, 3.$$

$$A - 0I = \begin{pmatrix} 1 & -1 & 0 \\ -1 & 2 & -1 \\ 0 & -1 & 1 \end{pmatrix} \rightarrow \begin{pmatrix} 1 & -1 & 0 \\ 0 & 1 & -1 \\ 0 & -1 & 1 \end{pmatrix} \rightarrow \begin{pmatrix} 1 & 0 & -1 \\ 0 & 1 & -1 \\ 0 & 0 & 0 \end{pmatrix} \Rightarrow E_0 = \text{span} \left\{ \begin{pmatrix} 1 \\ 1 \\ 1 \end{pmatrix} \right\}$$

$$A - I = \begin{pmatrix} 0 & -1 & 0 \\ -1 & 1 & -1 \\ 0 & -1 & 0 \end{pmatrix} \Rightarrow E_1 = \text{span} \left\{ \begin{pmatrix} -1 \\ 0 \\ 1 \end{pmatrix} \right\}$$

$$A - 3I = \begin{pmatrix} -2 & -1 & 0 \\ -1 & -1 & -1 \\ 0 & -1 & -2 \end{pmatrix} \rightarrow \begin{pmatrix} 1 & 1 & 1 \\ 0 & 1 & 2 \\ 0 & -1 & -2 \end{pmatrix} \rightarrow \begin{pmatrix} 1 & 0 & -1 \\ 0 & 1 & 2 \\ 0 & 0 & 0 \end{pmatrix} \Rightarrow E_3 = \text{span} \left\{ \begin{pmatrix} 1 \\ -2 \\ 1 \end{pmatrix} \right\}$$

8. $\begin{vmatrix} 1-\lambda & 1 & -2 \\ -1 & 2-\lambda & 1 \\ 0 & 1 & -1-\lambda \end{vmatrix} = -\lambda^3 + 2\lambda + \lambda - 2 = -(\lambda - 1)(\lambda - 2)(\lambda + 1)$; Eigenvalues: 1, 2, -1. (See the solutions to MATLAB 6.1.3(a) for a way to use row operations to find this characteristic polynomial in factored form.)

$$A - I = \begin{pmatrix} 0 & 1 & -2 \\ -1 & 1 & 1 \\ 0 & 1 & -2 \end{pmatrix} \rightarrow \begin{pmatrix} 1 & -1 & -1 \\ 0 & 1 & -2 \\ 0 & 1 & -2 \end{pmatrix} \rightarrow \begin{pmatrix} 1 & 0 & -3 \\ 0 & 1 & -2 \\ 0 & 0 & 0 \end{pmatrix} \Rightarrow E_1 = \text{span} \left\{ \begin{pmatrix} 3 \\ 2 \\ 1 \end{pmatrix} \right\}$$

$$A - 2I = \begin{pmatrix} -1 & 1 & -2 \\ -1 & 0 & 1 \\ 0 & 1 & -3 \end{pmatrix} \rightarrow \begin{pmatrix} 1 & -1 & 2 \\ 0 & 1 & -3 \\ 0 & 1 & -3 \end{pmatrix} \rightarrow \begin{pmatrix} 1 & 0 & -1 \\ 0 & 1 & -3 \\ 0 & 0 & 0 \end{pmatrix} \Rightarrow E_2 = \text{span} \left\{ \begin{pmatrix} 1 \\ 3 \\ 1 \end{pmatrix} \right\}$$

$$A + I = \begin{pmatrix} 2 & 1 & -2 \\ -1 & 3 & 1 \\ 0 & 1 & 0 \end{pmatrix} \rightarrow \begin{pmatrix} 1 & -3 & -1 \\ 0 & 1 & 0 \\ 0 & 7 & 0 \end{pmatrix} \rightarrow \begin{pmatrix} 1 & 0 & -1 \\ 0 & 1 & 0 \\ 0 & 0 & 0 \end{pmatrix} \Rightarrow E_{-1} = \text{span} \left\{ \begin{pmatrix} 1 \\ 0 \\ 1 \end{pmatrix} \right\}$$

9. $\begin{vmatrix} 5-\lambda & 4 & 2 \\ 4 & 5-\lambda & 2 \\ 2 & 2 & 2-\lambda \end{vmatrix} = -\lambda^3 + 12\lambda^2 - 21\lambda + 10 = -(\lambda - 1)^2(\lambda - 10)$; Eigenvalues: 1, 1, 10

$$A - I = \begin{pmatrix} 4 & 4 & 2 \\ 4 & 4 & 2 \\ 2 & 2 & 1 \end{pmatrix} \Rightarrow E_1 = \text{span} \left\{ \begin{pmatrix} 1 \\ 0 \\ -2 \end{pmatrix}, \begin{pmatrix} 0 \\ 1 \\ -2 \end{pmatrix} \right\}; \text{Geom. multiplicity of 1 is 2.}$$

$$A - 10I = \begin{pmatrix} -5 & 4 & 2 \\ 4 & -5 & 2 \\ 2 & 2 & -8 \end{pmatrix} \rightarrow \begin{pmatrix} 1 & 1 & -4 \\ 0 & 9 & -18 \\ 0 & -9 & 18 \end{pmatrix} \rightarrow \begin{pmatrix} 1 & 0 & -2 \\ 0 & 1 & -2 \\ 0 & 0 & 0 \end{pmatrix} \Rightarrow E_{10} = \text{span} \left\{ \begin{pmatrix} 2 \\ 2 \\ 1 \end{pmatrix} \right\}$$

10. $\begin{vmatrix} 1-\lambda & 2 & 2 \\ 0 & 2-\lambda & 1 \\ -1 & 2 & 2-\lambda \end{vmatrix} = -\lambda^3 + 5\lambda^2 - 8\lambda + 4 = -(\lambda - 1)(\lambda - 2)^2$; Eigenvalues: 1, 2, 2

$$A - I = \begin{pmatrix} 0 & 2 & 2 \\ 0 & 1 & 1 \\ -1 & 2 & 1 \end{pmatrix} \rightarrow \begin{pmatrix} 1 & 0 & 3 \\ 0 & 1 & 1 \\ 0 & 0 & 0 \end{pmatrix} \Rightarrow E_1 = \text{span} \left\{ \begin{pmatrix} -3 \\ -1 \\ 1 \end{pmatrix} \right\}$$

$$A - 2I = \begin{pmatrix} -1 & 2 & 2 \\ 0 & 0 & 1 \\ -1 & 2 & 0 \end{pmatrix} \rightarrow \begin{pmatrix} 1 & -2 & -2 \\ 0 & 0 & 1 \\ 0 & 0 & 2 \end{pmatrix} \rightarrow \begin{pmatrix} 1 & -2 & 0 \\ 0 & 0 & 1 \\ 0 & 0 & 0 \end{pmatrix} \Rightarrow E_2 = \text{span} \left\{ \begin{pmatrix} 2 \\ 1 \\ 0 \end{pmatrix} \right\}$$

Geometric multiplicity of 2 is 1.

11. $\begin{vmatrix} -\lambda & 1 & 0 \\ 0 & -\lambda & 1 \\ 1 & -3 & 3-\lambda \end{vmatrix} = -\lambda^3 + 3\lambda^2 - 3\lambda + 1 = -(\lambda - 1)^3$; Eigenvalues: 1, 1, 1

$$A - I = \begin{pmatrix} -1 & 1 & 0 \\ 0 & -1 & 1 \\ 1 & -3 & 2 \end{pmatrix} \rightarrow \begin{pmatrix} 1 & -1 & 0 \\ 0 & 1 & -1 \\ 0 & -2 & 2 \end{pmatrix} \rightarrow \begin{pmatrix} 1 & 0 & -1 \\ 0 & 1 & -1 \\ 0 & 0 & 0 \end{pmatrix} \Rightarrow E_1 = \text{span} \left\{ \begin{pmatrix} 1 \\ 1 \\ 1 \end{pmatrix} \right\}$$

Geometric multiplicity of 1 is 1.

$$12. \begin{vmatrix} -3-\lambda & -7 & -5 \\ 2 & 4-\lambda & 3 \\ 1 & 2 & 2-\lambda \end{vmatrix} = -\lambda^3 + 3\lambda^2 - 3\lambda + 1 = -(\lambda - 1)^3; \text{ Eigenvalues: } 1, 1, 1$$

$$A - I = \begin{pmatrix} -4 & -7 & -5 \\ 2 & 3 & 3 \\ 1 & 2 & 1 \end{pmatrix} \rightarrow \begin{pmatrix} 1 & 2 & 1 \\ 0 & 1 & -1 \\ 0 & 1 & -1 \end{pmatrix} \rightarrow \begin{pmatrix} 1 & 0 & 3 \\ 0 & 1 & -1 \\ 0 & 0 & 0 \end{pmatrix} \Rightarrow E_1 = \text{span} \left\{ \begin{pmatrix} -3 \\ 1 \\ 1 \end{pmatrix} \right\}$$

Geometric multiplicity of 1 is 1.

$$13. \begin{vmatrix} 1-\lambda & -1 & -1 \\ 1 & -1-\lambda & 0 \\ 1 & 0 & -1-\lambda \end{vmatrix} = -(\lambda^3 + \lambda^2 + \lambda + 1) = -(\lambda + 1)(\lambda^2 + 1); \text{ Eigenvalues: } -1, i, -i \text{ (See the$$

solutions to MATLAB 6.1.3(a) for a way to use row operations to find this characteristic polynomial in factored form.)

$$A + I = \begin{pmatrix} 2 & -1 & -1 \\ 1 & 0 & 0 \\ 1 & 0 & 0 \end{pmatrix} \Rightarrow E_{-1} = \text{span} \left\{ \begin{pmatrix} 0 \\ -1 \\ 1 \end{pmatrix} \right\}$$

$$A - iI = \begin{pmatrix} 1-i & -1 & -1 \\ 1 & -1-i & 0 \\ 1 & 0 & -1-i \end{pmatrix} \rightarrow \begin{pmatrix} 1 & 0 & -1-i \\ 0 & 1 & -1 \\ 0 & -1-i & 1+i \end{pmatrix} \rightarrow \begin{pmatrix} 1 & 0 & -1-i \\ 0 & 1 & -1 \\ 0 & 0 & 0 \end{pmatrix} \Rightarrow E_i = \text{span} \left\{ \begin{pmatrix} 1+i \\ 1 \\ 1 \end{pmatrix} \right\}.$$

$$\text{Then } E_{-i} = \text{span} \left\{ \begin{pmatrix} 1-i \\ 1 \\ 1 \end{pmatrix} \right\}.$$

$$14. \begin{vmatrix} 7-\lambda & -2 & -4 \\ 3 & -\lambda & -2 \\ 6 & -2 & -3-\lambda \end{vmatrix} = -\lambda^3 + 4\lambda^2 - 5\lambda + 2 = -(\lambda - 1)^2(\lambda - 2); \text{ Eigenvalues: } 1, 1, 2$$

$$A - I = \begin{pmatrix} 6 & -2 & -4 \\ 3 & -1 & -2 \\ 6 & -2 & -2 \end{pmatrix} \rightarrow \begin{pmatrix} 1 & -1/3 & -2/3 \\ 0 & 0 & 0 \\ 0 & 0 & 2 \end{pmatrix} \Rightarrow E_1 = \text{span} \left\{ \begin{pmatrix} 1 \\ 3 \\ 0 \end{pmatrix}, \begin{pmatrix} 2 \\ 0 \\ 3 \end{pmatrix} \right\}$$

Geometric multiplicity of 1 is 2.

$$A - 2I = \begin{pmatrix} 5 & -2 & -4 \\ 3 & -2 & -2 \\ 6 & -2 & -5 \end{pmatrix} \rightarrow \begin{pmatrix} 1 & -0.4 & -0.8 \\ 0 & -0.8 & 0.4 \\ 0 & 0.4 & -0.2 \end{pmatrix} \rightarrow \begin{pmatrix} 1 & 0 & -1 \\ 0 & 1 & -0.5 \\ 0 & 0 & 0 \end{pmatrix} \Rightarrow E_2 = \text{span} \left\{ \begin{pmatrix} 2 \\ 1 \\ 2 \end{pmatrix} \right\}$$

$$15. \begin{vmatrix} 4-\lambda & 6 & 6 \\ 1 & 3-\lambda & 2 \\ -1 & -5 & -2-\lambda \end{vmatrix} = -\lambda^3 + 5\lambda^2 - 8\lambda + 4 = -(\lambda - 1)(\lambda - 2)^2; \text{ Eigenvalues: } 1, 2, 2$$

$$A - I = \begin{pmatrix} 3 & 6 & 6 \\ 1 & 2 & 2 \\ -1 & -5 & -3 \end{pmatrix} \rightarrow \begin{pmatrix} 1 & 2 & 2 \\ 0 & 0 & 0 \\ 0 & -3 & -1 \end{pmatrix} \rightarrow \begin{pmatrix} 1 & 0 & 4/3 \\ 0 & 0 & 0 \\ 0 & 1 & 1/3 \end{pmatrix} \Rightarrow E_1 = \text{span} \left\{ \begin{pmatrix} 4 \\ 1 \\ -3 \end{pmatrix} \right\}$$

$$A - 2I = \begin{pmatrix} 2 & 6 & 6 \\ 1 & 1 & 2 \\ -1 & -5 & -4 \end{pmatrix} \rightarrow \begin{pmatrix} 1 & 3 & 3 \\ 0 & 2 & 1 \\ 0 & -2 & -1 \end{pmatrix} \rightarrow \begin{pmatrix} 1 & 0 & 3/2 \\ 0 & 1 & 1/2 \\ 0 & 0 & 0 \end{pmatrix} \Rightarrow E_2 = \text{span} \left\{ \begin{pmatrix} 3 \\ 1 \\ -2 \end{pmatrix} \right\}$$

Geometric multiplicity of 2 is 1.

$$16. \begin{vmatrix} 4-\lambda & 1 & 0 & 1 \\ 2 & 3-\lambda & 0 & 1 \\ -2 & 1 & 2-\lambda & -3 \\ 2 & -1 & 0 & 5-\lambda \end{vmatrix} = (2 - \lambda)(48 - 44\lambda + 12\lambda^2 - \lambda^3) = (\lambda - 2)^2(\lambda - 4)(\lambda - 6);$$

Eigenvalues: 2, 2, 4, 6

$$A - 2I = \begin{pmatrix} 2 & 1 & 0 & 1 \\ 2 & 1 & 0 & 1 \\ -2 & 1 & 0 & -3 \\ 2 & -1 & 0 & 3 \end{pmatrix} \rightarrow \begin{pmatrix} 1 & 1/2 & 0 & 1/2 \\ 0 & 0 & 0 & 0 \\ 0 & 2 & 0 & -2 \\ 0 & 2 & 0 & -2 \end{pmatrix} \rightarrow \begin{pmatrix} 1 & 0 & 0 & 1 \\ 0 & 0 & 0 & 0 \\ 0 & 1 & 0 & -1 \\ 0 & 0 & 0 & 0 \end{pmatrix} \Rightarrow E_2 =$$

$$\text{span} \left\{ \begin{pmatrix} -1 \\ 1 \\ 1 \\ 1 \end{pmatrix}, \begin{pmatrix} -1 \\ 1 \\ 0 \\ 1 \end{pmatrix} \right\}$$

Geometric multiplicity of 2 is 2.

$$A - 4I = \begin{pmatrix} 0 & 1 & 0 & 1 \\ 2 & -1 & 0 & 1 \\ -2 & 1 & -2 & -3 \\ 2 & -1 & 0 & 1 \end{pmatrix} \rightarrow \begin{pmatrix} 1 & -1/2 & 0 & 1/2 \\ 0 & 1 & 0 & 1 \\ 0 & 0 & 1 & 1 \\ 0 & 0 & 0 & 0 \end{pmatrix} \Rightarrow E_4 = \text{span} \left\{ \begin{pmatrix} -1 \\ -1 \\ -1 \\ 1 \end{pmatrix} \right\}$$

$$A - 6I = \begin{pmatrix} -2 & 1 & 0 & 1 \\ 2 & -2 & 0 & 1 \\ -2 & 1 & -4 & -3 \\ 2 & -1 & 0 & -1 \end{pmatrix} \rightarrow \begin{pmatrix} 1 & -1/2 & 0 & 1/2 \\ 0 & -1 & 0 & 2 \\ 0 & 0 & 4 & 4 \\ 0 & 0 & 0 & 0 \end{pmatrix} \Rightarrow E_6 = \text{span} \left\{ \begin{pmatrix} 1 \\ 4 \\ -2 \\ 2 \end{pmatrix} \right\}$$

$$17. \begin{vmatrix} a - \lambda & 0 & 0 & 0 \\ 0 & a - \lambda & 0 & 0 \\ 0 & 0 & a - \lambda & 0 \\ 0 & 0 & 0 & a - \lambda \end{vmatrix} = (a - \lambda)^4; \text{ Eigenvalues: } a, a, a, a$$

$$A - aI = \begin{pmatrix} 0 & 0 & 0 & 0 \\ 0 & 0 & 0 & 0 \\ 0 & 0 & 0 & 0 \\ 0 & 0 & 0 & 0 \end{pmatrix} \Rightarrow E_a = \mathbb{R}^4. \text{ Geometric multiplicity of } a \text{ is 4.}$$

$$18. \begin{vmatrix} a - \lambda & b & 0 & 0 \\ 0 & a - \lambda & 0 & 0 \\ 0 & 0 & a - \lambda & 0 \\ 0 & 0 & 0 & a - \lambda \end{vmatrix} = (a - \lambda)^4; \text{ Eigenvalues: } a, a, a, a$$

$$A - aI = \begin{pmatrix} 0 & b & 0 & 0 \\ 0 & 0 & 0 & 0 \\ 0 & 0 & 0 & 0 \\ 0 & 0 & 0 & 0 \end{pmatrix} \Rightarrow E_a = \text{span} \left\{ \begin{pmatrix} 1 \\ 0 \\ 0 \\ 0 \end{pmatrix}, \begin{pmatrix} 0 \\ 0 \\ 1 \\ 0 \end{pmatrix}, \begin{pmatrix} 0 \\ 0 \\ 0 \\ 1 \end{pmatrix} \right\}.$$

Geometric multiplicity of a is 3.

$$19. \begin{vmatrix} a - \lambda & b & 0 & 0 \\ 0 & a - \lambda & c & 0 \\ 0 & 0 & a - \lambda & 0 \\ 0 & 0 & 0 & a - \lambda \end{vmatrix} = (a - \lambda)^4; \text{ Eigenvalues: } a, a, a, a$$

$$A - aI = \begin{pmatrix} 0 & b & 0 & 0 \\ 0 & 0 & c & 0 \\ 0 & 0 & 0 & 0 \\ 0 & 0 & 0 & 0 \end{pmatrix} \Rightarrow E_a = \text{span} \left\{ \begin{pmatrix} 1 \\ 0 \\ 0 \\ 0 \end{pmatrix}, \begin{pmatrix} 0 \\ 0 \\ 0 \\ 1 \end{pmatrix} \right\}.$$

Geometric multiplicity of a is 2.

$$20. \begin{vmatrix} a - \lambda & b & 0 & 0 \\ 0 & a - \lambda & c & 0 \\ 0 & 0 & a - \lambda & d \\ 0 & 0 & 0 & a - \lambda \end{vmatrix} = (a - \lambda)^4; \text{ Eigenvalues: } a, a, a, a$$

$$A - aI = \begin{pmatrix} 0 & b & 0 & 0 \\ 0 & 0 & c & 0 \\ 0 & 0 & 0 & d \\ 0 & 0 & 0 & 0 \end{pmatrix} \Rightarrow E_a = \text{span} \left\{ \begin{pmatrix} 1 \\ 0 \\ 0 \\ 0 \end{pmatrix} \right\}, \text{ Geometric multiplicity of } a \text{ is 1.}$$

21. $\begin{vmatrix} a-\lambda & b \\ -b & a-\lambda \end{vmatrix} = (a-\lambda)^2 + b^2$; Eigenvalues: $a+bi$, $a-bi$
- $$A - (a+bi)I = \begin{pmatrix} -bi & b \\ -b & -bi \end{pmatrix}; \begin{pmatrix} -bi & b \\ -b & -bi \end{pmatrix} \begin{pmatrix} 1 \\ i \end{pmatrix} = \begin{pmatrix} 0 \\ 0 \end{pmatrix}$$
- $$A - (a-bi)I = \begin{pmatrix} bi & b \\ -b & bi \end{pmatrix}; \begin{pmatrix} bi & b \\ -b & bi \end{pmatrix} \begin{pmatrix} 1 \\ -i \end{pmatrix} = \begin{pmatrix} 0 \\ 0 \end{pmatrix}$$
- Thus $\begin{pmatrix} 1 \\ i \end{pmatrix}$ and $\begin{pmatrix} 1 \\ -i \end{pmatrix}$ are eigenvectors of $A = \begin{pmatrix} a & b \\ -b & a \end{pmatrix}$.
22. Note that $\det(A^t - \lambda I) = \det(A - \lambda I)^t = \det(A - \lambda I)$. Then the characteristic equations for A and A^t are the same and thus A and A^t will have the same eigenvalues.
23. For each λ_i , $1 \leq i \leq k$, there exists $\mathbf{x}_i \neq 0$ such that $A\mathbf{x}_i = \lambda_i\mathbf{x}_i$. Then $\alpha A\mathbf{x}_i = \alpha\lambda_i\mathbf{x}_i$. Thus $\alpha\lambda_i$, $1 \leq i \leq k$, are eigenvalues for αA . Conversely if $\alpha \neq 0$ and ν_i is an eigenvalue for αA with eigenvector \mathbf{x} , then $(\alpha A)\mathbf{x} = \nu_i\mathbf{x}$, so $A\mathbf{x} = \frac{\nu_i}{\alpha}\mathbf{x}$. Thus $\frac{\nu_i}{\alpha} = \lambda_i$ or $\nu_i = \alpha\lambda_i$ some i .
24. Note that A^{-1} exists if and only if $A\mathbf{x} = 0$ only for $\mathbf{x} = 0$, i.e. if and only if 0 is not an eigenvalue for A . This gives the result.
25. Using the same notation as in problem 23, we have $A\mathbf{x}_i = \lambda_i\mathbf{x}_i$. Then $\mathbf{x}_i = A^{-1}\lambda_i\mathbf{x}_i$. Then $\frac{1}{\lambda_i}\mathbf{x}_i = A^{-1}\mathbf{x}_i$. Thus, $\frac{1}{\lambda_i}$, $1 \leq i \leq k$, are eigenvalues for A^{-1} , and reversing the roles of A, A^{-1} , we get $1/\lambda_i$ are all the eigenvalues.
26. Using the same notation as in problem 23, we have $(A - \alpha I)\mathbf{x}_i = A\mathbf{x}_i - \alpha\mathbf{x}_i = (\lambda_i - \alpha)\mathbf{x}_i$. Thus $\lambda_i - \alpha$, $1 \leq i \leq k$, are eigenvalues of $A - \alpha I$. Conversely, if $(A - \alpha I)\mathbf{x} = \lambda\mathbf{x}$, then $A\mathbf{x} = (\lambda + \alpha)\mathbf{x}$, so $\lambda + \alpha = \lambda_i$ i.e. $\lambda = \lambda_i - \alpha$.
27. Using the same notation as in problem 23, we have $A^2\mathbf{x}_i = A(A\mathbf{x}_i) = A\lambda_i\mathbf{x}_i = \lambda_i A\mathbf{x}_i = \lambda_i^2\mathbf{x}_i$. Thus λ_i^2 , $1 \leq i \leq k$, are eigenvalues of A^2 . Conversely, if $A^2\mathbf{x} = \nu\mathbf{x}$ then $(A^2 - \nu I)\mathbf{x} = 0$ or $(A + \sqrt{\nu}I)(A - \sqrt{\nu}I)\mathbf{x} = 0$. Hence either $(A - \sqrt{\nu}I)\mathbf{x} = 0$ or $\mathbf{y} = (A + \sqrt{\nu}I)\mathbf{x} \neq 0$ and $(A + \sqrt{\nu}I)\mathbf{y} = 0$. These say one of $\pm\sqrt{\nu}$ is an eigenvalue for A , i.e. $\pm\sqrt{\nu} = \lambda_i$ some i , or $\nu = \lambda_i^2$.
28. Assume \mathbf{x}_i is an eigenvector for A for the eigenvalue λ_i . Then $A^n\mathbf{x}_i = A^{n-1}(A\mathbf{x}_i) = A^{n-1}(\lambda_i\mathbf{x}_i) = \lambda_i(A^{n-1}\mathbf{x}_i)$. Now repeating this argument $n-1$ more times yields $A^n\mathbf{x}_i = \lambda_i^n\mathbf{x}_i$. Thus each λ_i^n is an eigenvalue for A^n . Conversely, suppose ν is a (complex) eigenvalue for A^n with an associated eigenvector \mathbf{x} and $\lambda = \sqrt[n]{\nu}$ is one complex n 'th root of ν . Then $A^n - \nu I = \prod_{j=1}^n (A - e^{2\pi i j/n} \lambda I)$. Let $\mathbf{y}_0 = \mathbf{x}$ and $\mathbf{y}_m = \prod_{j=1}^m (A - e^{2\pi i j/n} \lambda I)\mathbf{x}$ for $m = 1, \dots, n$. Since $\mathbf{y}_n = (A^n - \nu I)\mathbf{x} = 0$, there exists a smallest $k > 0$ with $\mathbf{y}_k = 0$. Since $k > 0$, $\mathbf{y}_{k-1} \neq 0$ and $(A - e^{2\pi i k/n} \lambda I)\mathbf{y}_{k-1} = \mathbf{y}_k = 0$. This says $e^{2\pi i k/n} \lambda$ is an eigenvalue for A , so $\lambda_l = e^{2\pi i k/n} \lambda$, for some l . But $\lambda_l^n = (e^{2\pi i k/n} \lambda)^n = \lambda^n = \nu$, i.e. $\nu = \lambda_l^n$. This shows every eigenvalue of A^n is the n 'th power of some eigenvalue of A and finishes the solution.
- 29.
- $$\begin{aligned} p(A)\mathbf{v} &= (a_0I + a_1A + \dots + a_nA^n)\mathbf{v} \\ &= a_0\mathbf{v} + a_1A\mathbf{v} + \dots + a_nA^n\mathbf{v} \\ &= a_0\mathbf{v} + a_1\lambda\mathbf{v} + \dots + a_n\lambda^n\mathbf{v} \\ &= (a_0 + a_1\lambda + \dots + a_n\lambda^n)\mathbf{v} = p(\lambda)\mathbf{v}. \end{aligned}$$
30. Using the same notation as in problem 23 and the result of problem 29, we have $p(A)\mathbf{x}_i = p(\lambda_i)\mathbf{x}_i$, for $1 \leq i \leq k$. Then $p(\lambda_i)$, $1 \leq i \leq k$, are eigenvalues of $p(A)$. (Note it takes a lot more work to show there are no other eigenvalues for $p(A)$.)

31. Let $A = \begin{pmatrix} a_{11} & 0 & \cdots & 0 \\ 0 & a_{22} & 0 & 0 \\ \vdots & \ddots & & \vdots \\ 0 & \cdots & 0 & a_{nn} \end{pmatrix}$. λ is an eigenvalue of A if and only if $\det(A - \lambda I) =$

$$\det \begin{pmatrix} a_{11} - \lambda & 0 & \cdots & 0 \\ 0 & a_{22} - \lambda & \cdots & 0 \\ \vdots & \ddots & \ddots & \vdots \\ 0 & \cdots & 0 & a_{nn} - \lambda \end{pmatrix} = (a_{11} - \lambda)(a_{22} - \lambda) \cdots (a_{nn} - \lambda) = 0 \text{ if and only if } \lambda = a_{ii} \text{ for}$$

some i with $1 \leq i \leq n$. Thus λ is an eigenvalue of A if and only if λ is a diagonal component of A .

32. Using the results of problems 17, 18, 19 and 20, we have that $\lambda = 2$ is an eigenvalue of algebraic multiplicity four for A_1, A_2, A_3 and A_4 . For A_1 , the geometric multiplicity of 2 is 4. For A_2 , the geometric multiplicity of 2 is 3. For A_3 , the geometric multiplicity of 2 is 2. For A_4 , the geometric multiplicity of 2 is 1.

33. Suppose that $A\mathbf{v} = \lambda\mathbf{v}$ where $\mathbf{v} \neq 0$. Then we have $\overline{A\mathbf{v}} = \overline{\lambda\mathbf{v}}$, and $\overline{A} \cdot \overline{\mathbf{v}} = \overline{\lambda} \cdot \overline{\mathbf{v}}$. But, since A is real, $\overline{A} = A$. So $A \cdot \overline{\mathbf{v}} = \overline{\lambda} \cdot \overline{\mathbf{v}}$, and $\overline{\mathbf{v}} \neq 0$. Then $\overline{\lambda}$ is an eigenvalue of A with corresponding eigenvector $\overline{\mathbf{v}}$.

34. Note that $A^t \begin{pmatrix} 1 \\ 1 \\ \vdots \\ 1 \end{pmatrix} = \begin{pmatrix} 1 \\ 1 \\ \vdots \\ 1 \end{pmatrix}$ since the column sums of A are 1. Thus 1 is an eigenvalue of A^t with

corresponding eigenvector $\begin{pmatrix} 1 \\ 1 \\ \vdots \\ 1 \end{pmatrix}$. Thus 1 is an eigenvalue for A (as $\det(A - I) = \det(A^t - I) = 0$).

35. One needs only to calculate $\begin{pmatrix} a & b \\ c & d \end{pmatrix} \begin{pmatrix} 1 \\ m \end{pmatrix} = (a + bm) \begin{pmatrix} 1 \\ m \end{pmatrix}$, which is true since $c + dm = am + bm^2$.

36. Check that $\begin{pmatrix} a & 0 \\ c & d \end{pmatrix} \begin{pmatrix} 0 \\ 1 \end{pmatrix} = d \begin{pmatrix} 0 \\ 1 \end{pmatrix}$.

CALCULATOR SOLUTIONS 6.1

Problems 37-40 ask for the eigenvalues and eigenvectors of the matrix A_{61nn} given in the problem. Once the matrix has been entered we can find the eigenvalues by $\text{EIGVL } A_{61nn}$ $\boxed{\text{ENTER}}$ and the eigenvectors by $\text{EIGVC } A_{61nn}$ $\boxed{\text{ENTER}}$. Of course we could also use the **MATRIX MATH** menu entries for $\mathbf{eigV1}$ and \mathbf{eigVc} as described in the text. We shall only display 8 digit answers.

37. $\text{EIGVL } A_{6137}$ $\boxed{\text{STO}} \text{ VL6137}$ $\boxed{\text{ENTER}}$ yields the list of eigenvalues

{ (12.70899744, 0) (1.20237104, 0) (-.95568424, .62887873) (-.95568424, -.62887873) }

(The ordered pairs in this list stand for complex numbers. So for this problem the first two entries are real, as their "imaginary" second component is 0. Also note that the TI-85 "list", displayed using the "{" and "}" delimiters is ordered, rather than just a "set", which is what these delimiters usually enclose.)

$\text{EIGVC } A_{6137}$ $\boxed{\text{STO}} \text{ VC6137}$ $\boxed{\text{ENTER}}$ yields the matrix

```
[ [ (-.62142715,0) (.71687784,0) (0.04543794,-3.19251194) (.04543794, 3.19251194) ]
[ (-.31716213,0) (-.10298644,0) (-.48915686,-1.06860326) (-.48915686, 1.06860326) ]
[ (-.60074151,0) (.46085995,0) (.56855460,-1.47374850) (.56855460, 1.47374850) ]
[ (-.64889372,0) (-.47071528,0) (.18909574, 3.31095939) (.18909574,-3.31095939) ] ]
```

whose columns are eigenvectors corresponding (in order) to the eigenvalues in the preceding list. One way to check that a given column, say column 3, is an eigenvector for the corresponding eigenvalue, $\text{VL6137}(3)$, is to check if this column, $\text{VC6137}(1,3,4,3)$, is in the nullspace of $A_{6137} - \text{VL6137}(3) * \text{IDENT}(4)$. (Recall that $A(1, j, m, j)$ will pick out the j 'th column of a matrix with m rows.) To do this compute $(A_{6137} - \text{VL6137}(3) * \text{IDENT}(4)) * \text{VC6137}(1,3,4,3)$ $\boxed{\text{ENTER}}$. This should result in zero (or something whose magnitude is essentially zero in comparison to the size of the eigenvector).

38. The eigenvalues, computed by $\text{EIGVL } A_{6138}$ $\boxed{\text{STO}} \text{ VL6138}$ $\boxed{\text{ENTER}}$ are

{ 136.13587917 9.78673411 -159.92261328 }.

The eigenvectors corresponding to these values are the columns produced by the computation $\text{EIGVC } A_{6138}$ $\boxed{\text{STO}} \text{ VC6138}$ $\boxed{\text{ENTER}}$ which yields the matrix

```
[ [ .80930625 -.41169877 .17282897 ]
[ .39760427 .79901338 .43021881 ] .
[ .57142906 .83487921 -.72384660 ] ]
```

39. The eigenvalues, computed by $\text{EIGVL } A_{6139}$ $\boxed{\text{STO}} \text{ VL6139}$ $\boxed{\text{ENTER}}$ are

{ -.07020742 .01316718 .13104024 }.

The eigenvectors corresponding to these values are the columns produced by the computation $\text{EIGVC } A_{6139}$ $\boxed{\text{STO}} \text{ VC6139}$ $\boxed{\text{ENTER}}$ which yields the matrix

```
[ [ -.86904182 -1.13177594 .03887837 ]
[ -.05274303 -.76511960 1.21858620 ] .
[ .40418751 .13423638 -.98551797 ] ]
```

40. The eigenvalues, computed by $\text{EIGVL } A_{6140}$ $\boxed{\text{STO}} \text{ VL6140}$ $\boxed{\text{ENTER}}$ are

{ (155.9214241, 0) (-6.19652391, 0) (3.80142163, 6.21858347) (3.80142163, -6.21858347) (9.67225655, 0) }.

The eigenvectors corresponding to these values are the columns produced by the computation EIGVC A6140

STO▶ VC6140 **ENTER** which yields the matrix

```
[ [ (.30391413, 0) (-.41583517, 0) (.07216788, .02724822)
  [ (.43510240, 0) (.35954684, 0) (.49417683, -.12406035)
  [ (.85461548, 0) (-.63331201, 0) (-.11345962, 1.60773524) . . .
  [ (.77355755, 0) (.29739916, 0) (-.06111309, -.74473569)
  [ (.85494504, 0) (.31477757, 0) (-.36238989, -.37130114)

      (.07216788, -.02724822) (-.18257769, 0) ]
      (.49417683, .12406035) (.65346843, 0) ]
      (-.11345962, -1.60773524) (-2.15604928, 0) ] .
      (-.06111309, .74473569) (1.65335389, 0) ]
      (-.36238989, .37130114) (-.39568255, 0) ] ]
```

The upper triangular matrices in Problems 41-45 have all diagonal elements 6, so 6 is an eigenvalue of algebraic multiplicity 6, since $\det(A614n - \lambda I) = (6 - \lambda)^6$. (This part can be confirmed by the calculator, using the eigV1 function.) We (attempt to) find the geometric multiplicity of this eigenvalue by determining the number of linearly independent eigenvectors among the columns of the matrix produced by EIGVC A614n **ENTER**.

41. $6 * \text{IDENT}(6)$ **STO▶** A6141 : EIGVC A6141 **ENTER** produces $\begin{bmatrix} 1 & 0 & 0 & 0 & 0 & 0 \\ 0 & 1 & 0 & 0 & 0 & 0 \\ 0 & 0 & 1 & 0 & 0 & 0 \\ 0 & 0 & 0 & 1 & 0 & 0 \\ 0 & 0 & 0 & 0 & 1 & 0 \\ 0 & 0 & 0 & 0 & 0 & 1 \end{bmatrix}$. Of course all the columns of this identity matrix are independent, so the geometric multiplicity is 6.

42. We create the given matrix by copying the previous matrix and changing the (1,2) element to a 1, using the keystrokes A6141 **STO▶** A6142:1 **STO▶** A6142 (1, 2) **ENTER**. Then EIGVC A6142 **ENTER** produces the matrix of "eigenvectors" $\begin{bmatrix} 1 & -1 & 0 & 0 & 0 & 0 \\ 0 & 3.7E-13 & 0 & 0 & 0 & 0 \\ 0 & 0 & 1 & 0 & 0 & 0 \\ 0 & 0 & 0 & 1 & 0 & 0 \\ 0 & 0 & 0 & 0 & 1 & 0 \\ 0 & 0 & 0 & 0 & 0 & 1 \end{bmatrix}$. Now if we treat the $3.7E-13$ entry as zero, this becomes an echelon form matrix with 5 independent columns(1,3,4,5,6), corresponding to the 5 pivots. Thus the geometric multiplicity seems to be 5. See the explanation for the word "seems" in the solution to problem 43.

43. We create the given matrix by copying the previous matrix and changing the (2,3) and (3,4) elements to a 1, using the keystrokes A6142 **STO▶** A6143:1 **STO▶** A6143 (2, 3):1 **STO▶** A6143 (3, 4) **ENTER**. Then EIGVC A6143 **ENTER** produces the matrix of "eigenvectors" $\begin{bmatrix} 1 & -1 & 1 & -1 & 0 & 0 \\ 0 & 3.9E-13 & -3.9E-13 & 3.9E-13 & 0 & 0 \\ 0 & 0 & 1.521E-25 & -1.521E-25 & 0 & 0 \\ 0 & 0 & 0 & 5.9319E-38 & 0 & 0 \\ 0 & 0 & 0 & 0 & 1 & 0 \\ 0 & 0 & 0 & 0 & 0 & 1 \end{bmatrix}$.

If we treat all the very small entries as 0, then the first four columns are all multiples of each other, and so there are just 3 independent columns, {1,5,6} and it "seems" as if the geometric multiplicity is 3.

(The calculator's program for finding eigenvectors uses a successive approximation technique which identifies the current approximation as an eigenvector provided the next approximation differs from it by less than about 10^{-12} .

This yields the "strange" second, third and fourth columns (which are not a true eigenvectors), but differs from a true eigenvector (\pm column 1) by very little.)

We used the quoted "seems" above, since the approximations made by the calculator make it impossible to be sure. You might be interested in seeing what happens if you compute the eigenvectors and eigenvalues for the modification of problem 42 obtained by $A6142$ $\text{STO}\blacktriangleright$ $A:6-1$ EE $(-)$ 13 $\text{STO}\blacktriangleright$ $A(1,1)$. If you interpret the calculator results for the eigenvectors of this modified matrix as we did above, you conclude that 6 seems to be an eigenvalue of geometric multiplicity 5; in particular there do not seem to be 6 independent eigenvectors for the modified matrix. However a hand calculation shows that while 6 is an eigenvector of algebraic multiplicity 5, the "strange" second column of the eigenvector matrix is a true eigenvector for $6-1E-13$, and so the 6 columns of this matrix are 6 independent eigenvectors. In general you must be quite careful about drawing exact conclusions about these matters from the calculator results.

44. We create the given matrix by copying the previous matrix and changing the (4,5) element to a 1, using the keystrokes $A6143$ $\text{STO}\blacktriangleright$ $A6144:1$ $\text{STO}\blacktriangleright$ $A6144(4,5)$ ENTER . Then EIGVC $A6144$ ENTER

produces the matrix of "eigenvectors"
$$\begin{bmatrix} 1 & -1 & 1 & -1 & 1 & 0 \\ 0 & 4E-13 & -4E-13 & 4E-13 & -4E-13 & 0 \\ 0 & 0 & 1.6E-25 & -1.6E-25 & 1.6E-25 & 0 \\ 0 & 0 & 0 & 6.4E-38 & -6.4E-38 & 0 \\ 0 & 0 & 0 & 0 & 2.56E-50 & 0 \\ 0 & 0 & 0 & 0 & 0 & 1 \end{bmatrix}$$
. Again, if we treat all

the very small entries as 0, then the first five columns are all multiples of each other, and so there are just 2 independent columns, {1,6} and it seems as if the geometric multiplicity is 2.

45. We create the given matrix by copying the previous matrix and changing the (5,6) element to a 1, using the keystrokes $A6144$ $\text{STO}\blacktriangleright$ $A6145:1$ $\text{STO}\blacktriangleright$ $A6145(5,6)$ ENTER . Then EIGVC $A6145$ ENTER produces the matrix of "eigenvectors"

$$\begin{bmatrix} 1 & -1 & 1 & -1 & 1 & -1 \\ 0 & 4.1E-13 & -4.1E-13 & 4.1E-13 & -4.1E-13 & 4.1E-13 \\ 0 & 0 & 1.681E-25 & -1.681E-25 & 1.681E-25 & -1.681E-25 \\ 0 & 0 & 0 & 6.8921E-38 & -6.8921E-38 & 6.8921E-38 \\ 0 & 0 & 0 & 0 & 2.825761E-50 & -2.825761E-50 \\ 0 & 0 & 0 & 0 & 0 & 1.15856201E-62 \end{bmatrix}$$

Again, if we treat all the very small entries as 0, then the all six columns are multiples of each other, and so there is just one independent column and it seems as if the geometric multiplicity is 1.

MATLAB 6.1

1.

```
>> A = [ 38 -95 55; 35 -92 55; 35 -95 58];
```

(a)

```
>> x = [ 1 1 1]';
>> y = [ 3 4 5]';
>> z = [4 9 13]';
>> % One way to test if these are eigenvectors: see if A*v is a multiple of v
>> A*x
ans =
    -2
    -2
    -2
>> % Since A*x = -2*x, x is an eigenvector for the eigenvalue -2
>> A*y
ans =
     9
    12
    15
>> % Since A*y = 3*y, y is an eigenvector for the eigenvalue 3
>> A*z
ans =
    12
    27
    39
>> % Since A*z = 3*z, z is an eigenvector for the eigenvalue 3
```

Alternatively, given a vector w with a suggested eigenvalue c , we can just check if $(A - cI)w$ is zero:

```
>> (A-(-2)*eye(3))*x % This is zero, so x is eigenvector for eigenvalue -2
ans =
     0
     0
     0
>> (A-3*eye(3))*y % This is zero, so y is eigenvector for eigenvalue 3
ans =
     0
     0
     0
>> (A-3*eye(3))*z % This is zero, so z is also an eigenvector
ans = % for eigenvalue 3
     0
     0
     0
```

(b)

```

>> a=10*rand(1)-5
a =
   -2.8104
>> (A-(-2)*eye(3))*(a*x) % Shows a*x is an eigenvector for -2
ans =
   1.0e-13 *
         0
         0
    0.2842
>> (A-3*eye(3))*(a*z) % Essentially zero, so a*z is an eigenvector for 3
ans =
   1.0e-12 *
    0.2274
    0.2274
    0.2274

```

(c)

```

>> b=20*rand(1)-10 % Choose another random value
b =
   -5.6208
>> (A-3*eye(3))*(a*y+b*z) % Essentially zero,
ans =
   1.0e-12 *
    0.9095
    0.9095
    0.9095

```

(d) Parts (b) and (c) illustrate the fact the set of all w with $Aw = cw$ is a subspace. (Note that 0 is the only vector in this set that is not an eigenvector for A .)

2.

```

>> A = [ 1 1 .5 -1 ; -2 1 -1 0 ; 0 2 0 2 ; 2 1 -1.5 2]
A =
    1.0000    1.0000    0.5000   -1.0000
   -2.0000    1.0000   -1.0000     0
         0    2.0000         0    2.0000
    2.0000    1.0000   -1.5000    2.0000

```

(a)

```

>> x = [ 1 i 0 -i].'; % Recall that .' takes transposes of complex matrices
>> v = [ 0 i 2 1+i].';
>> lambda = 1+2*i ;
>> (A-lambda*eye(4))*x % Zero so x is an eigenvector for eigenvalue lambda
ans =
     0
     0
     0
     0
>> (A-lambda*eye(4))*v % Zero so v is an eigenvector for eigenvalue lambda
ans =
     0
     0
     0
     0

```

```

>> y = [ 1 -i 0 i].';
>> z = [ 0 -i 2 1-i].';
>> mu = 1-2*i ;
>> (A-mu*eye(4))*y % Zero so y is an eigenvector for eigenvalue mu
ans =
    0
    0
    0
    0
>> (A-mu*eye(4))*z % Zero so z is an eigenvector for eigenvalue mu
ans =
    0
    0
    0
    0

```

(b)

```

>> a = 5*(2*rand(1)-1)+i*3*rand(1)
a =
-2.8104 + 0.1411i
>> (A-lambda*eye(4))*(a*x), (A-lambda*eye(4))*(a*v),
ans =
 1.0e-16 *
    0
    0
    0
    0 - 0.5551i
ans =
 1.0e-15 *
    0
    0
-0.7772
    0

```

Since both answers are essentially zero, $a*x$ and $a*v$ are eigenvectors for λ .

```

>> (A-mu*eye(4))*(a*y), (A-mu*eye(4))*(a*z),
ans =
 1.0e-16 *
    0
    0
    0
    0 - 0.5551i
ans =
 1.0e-14 *
    0
    0
 0.0777
-0.1776

```

Since both answers are essentially zero, $a*y$ and $a*z$ are eigenvectors for μ .

(c)

```

>> b = 3*(2*rand(1)-1)+i*5*rand(1)
b =
  -1.6862 + 0.2352i
>> u = a*x+b*v;
>> (A-lambda*eye(4))*u % Zero up to roundoff,
ans = % so u "is" an eigenvector for lambda
  1.0e-15 *
  0.0555
  0
 -0.3331
  0.4441 + 0.8882i
>> w = a*y+b*z;
>> (A-mu*eye(4))*w % Zero up to roundoff,
ans = % so w "is" an eigenvector for mu
  1.0e-15 *
 -0.0555
  0
  0.3331
 -0.4441 + 0.8882i

```

(d) See solution to 1(d)

3. For Problem 1 with

```

>> A = [ -2 -2 ; -5 1];

```

(a) $\det(A - \lambda I) = (-2 - \lambda)(1 - \lambda) - (-2)(-5) = \lambda^2 + \lambda - 12 = (\lambda - 3)(\lambda + 4)$

```

>> [n,n]=size(A); c=(-1)^n*poly(A)
c =

```

```

  1    1   -12

```

In MATLAB `a = poly(A)` gives the coefficients of $\det(\lambda I - A) = \lambda^n + a_2\lambda^{n-1} + \dots + a_n\lambda + a_{n+1}$. This is $(-1)^n \det(A - \lambda I)$ for an $n \times n$ matrix.

(b) The roots are $\lambda_1 = 3$ and $\lambda_2 = -4$.

```

>> r=roots(c)
r =
  -4
   3

```

(c)

```

>> rref(A-r(1)*eye(n))
ans =
  1    -1
  0     0
>> % So an eigenvector for r(1) is the transpose of
>> v1 = [-ans(1,2) 1]
v1 =
  1    1
>> rref(A-r(2)*eye(n))
ans =
  1.0000    0.4000
  0         0
>> % So an eigenvector for r(2) is the transpose of
>> v2 = [-ans(1,2) 1]
v2 =
 -0.4000    1.0000

```

(d) Obviously 3 and -4 are two distinct eigenvalues and $n=2$.

```
>> rref([v1' v2']) % This is I so columns are independent.
ans =
     1     0
     0     1
```

Note the problem, as stated, is *slightly inaccurate*. What is true is that if you form a *set containing one eigenvector for each eigenvalue* that collection will be independent. It is not true that the set of all eigenvectors is independent.

(e)

```
>> [V,D] = eig(A);
>> for k = 1:n , (A-D(k,k)*eye(n))*V(:,k), end
ans =
     0
     0
ans =
     0
     0
```

Since $(A-D(k,k)*eye(n))*V(:,k) = 0$ each $V(:,k)$ is an eigenvector for the eigenvalue $D(k,k)$.

```
>> V\[(1/norm(v1))*v1' (1/norm(v2))*v2'] % Diagonal
ans = % so each vi/norm(vi) is di*V(:,i)
    -1.0000     0.0000
         0    -1.0000
```

For Problem 6 with

```
>> A = [ 3 2 ; -5 1];
```

(a) $\det(A - \lambda I) = (3 - \lambda)(1 - \lambda) - (2)(-5) = \lambda^2 - 4\lambda + 13$

```
>> [n,n]=size(A); c=(-1)^n*poly(A)
c =
     1    -4    13
```

(b) The roots are $\lambda_1 = (4 + \sqrt{-36})/2 = 2 + 3i$ and $\lambda_2 = 2 - 3i$.

```
>> r=roots(c)
r =
    2.0000 + 3.0000i
    2.0000 - 3.0000i
```

(c)

```
>> rref(A-r(1)*eye(n)) % Search for eigenvector for r(1) = 2+3i
ans =
    1.0000          0.2000 + 0.6000i
         0              0
>> % So an eigenvector for 2+3i is the transpose of
>> v1 = [-ans(1,2) 1]
v1 =
   -0.2000 - 0.6000i    1.0000
>> rref(A-r(2)*eye(n)) % Find eigenvectors for 2-3i (the conjugate of r(1))
ans =
    1.0000          0.2000 - 0.6000i
         0              0
>> % So an eigenvector for 2-3i is the transpose of
>> v2 = [-ans(1,2) 1]
v2 =
   -0.2000 + 0.6000i    1.0000
```

Note that v_2 is the conjugate of v_1 confirming the boxed fact on page 541.

(d) The two eigenvalues in (b) are distinct.

```
>> rref([v1.' v2.']) % This is I so columns are independent.
ans =
     1     0
     0     1
```

(e)

```
>> [V,D] = eig(A)
V =
 0.5071 - 0.1690i  0.5071 + 0.1690i
      0 + 0.8452i      0 - 0.8452i
D =
 2.0000 + 3.0000i      0
      0      2.0000 - 3.0000i
>> for k = 1:n , (A-D(k,k)*eye(n))*V(:,k), end
ans =
 1.0e-15 *
      0
      0 + 0.1110i
ans =
 1.0e-15 *
      0
      0 - 0.1110i
```

Since this gives $n=2$ (approximate) zero vectors, each $V(:,k)$ is an (approximate) eigenvector

```
>> V\[v1./norm(v1) v2./norm(v2)] % Diagonal
ans =
 0.0000 - 1.0000i  0.0000
 0.0000      0.0000 + 1.0000i
```

For problem 8 with

```
>> A = [ 1 1 -2; -1 2 1; 0 1 -1];
```

(a) $\det(A - \lambda I) = \begin{vmatrix} 1-\lambda & 1 & -2 \\ -1 & 2-\lambda & 1 \\ 0 & 1 & -1-\lambda \end{vmatrix} \stackrel{R_1+(1-\lambda)R_2}{=} \begin{vmatrix} 0 & 3-3\lambda+\lambda^2 & -1-\lambda \\ -1 & 2-\lambda & 1 \\ 0 & 1 & -1-\lambda \end{vmatrix} =$
 $-(-1)(-1-\lambda) \begin{vmatrix} 3-3\lambda+\lambda^2 & 1 \\ 1 & 1 \end{vmatrix} = (-1-\lambda)(2-3\lambda+\lambda^2) = (-1-\lambda)(2-\lambda)(1-\lambda)$, where
 we have used row operations, expansion along row 2, and factored out $(-1-\lambda)$ from column 2
 (after the expansion). Note this gives the characteristic polynomial in (easily) factored form.

```
>> [n,n]=size(A); c=(-1)^n*poly(A)
c =
 -1.0000    2.0000    1.0000   -2.0000
```

(b) The roots are $\lambda_1 = 2$, $\lambda_2 = 1$ and $\lambda_3 = -1$.

```
>> r=roots(c)
r =
 2.0000
 1.0000
-1.0000
```

(c)

```

>> rref(A-r(1)*eye(n))
ans =
    1.0000         0   -1.0000
         0    1.0000   -3.0000
         0         0         0
>> % So let x3=1, and solve to get an eigenvector for 2 as the transpose of
>> v1 = [-ans(1,3) -ans(2,3) 1]
v1 =
    1.0000    3.0000    1.0000
>> rref(A-r(2)*eye(n))
ans =
     1     0     0
     0     1     0
     0     0     1

```

Whoops, this has no zero rows, so seems to say $r(2)$ is not an eigenvalue for A . This is due to round-off problems: $r(2)$ is not exactly 1 so $A-r(2)*eye(3)$ does not compute to be singular. Try again with the exact eigenvalue:

```

>> rref(A-1*eye(n)) %This does yield a row of zeros.
ans =
     1     0    -3
     0     1    -2
     0     0     0
>> % So let x3=1, and solve to get an eigenvector for 1 as the transpose of
>> v2 = [-ans(1,3) -ans(2,3) 1]
v2 =
     3     2     1
>> rref(A-r(3)*eye(n))
ans =
    1.0000         0   -1.0000
         0    1.0000    0.0000
         0         0         0
>> % So let x3=1, and solve to get an eigenvector for -1 as the transpose of
>> v3 = [-ans(1,3) -ans(2,3) 1]
v3 =
    1.0000    0.0000    1.0000

```

(d) The three eigenvalues in (b) are distinct.

```

>> rref([v1.' v2.' v3.']) % This is I so eigenvector columns are independent.
ans =
     1     0     0
     0     1     0
     0     0     1

```

(e)

```

>> [V,D] = eig(A)
V =
   -0.8018    0.3015    0.7071
   -0.5345    0.9045    0.0000
   -0.2673    0.3015    0.7071
D =
    1.0000         0         0
         0    2.0000         0
         0         0   -1.0000
>> % Note the elements in r appear in a different order along the diagonal of D

>> % If zeros follow, V(:,k) is eigenvector for D(k,k)
>> for k = 1:n , (A-D(k,k)*eye(n))*V(:,k), end
ans =
    1.0e-15 *
   -0.1110
   -0.4441
   -0.1110
ans =
    1.0e-14 *
    0.2220
    0.0056
    0.0555
ans =
    1.0e-14 *
   -0.2220
    0.0333
   -0.0218

>> V\[v2./norm(v2) v1./norm(v1) v3./norm(v3)] % Match order of eigenvalues
ans =
   -1.0000    0.0000    0.0000
    0.0000    1.0000    0.0000
    0.0000    0.0000    1.0000

```

This is diagonal and shows $v1/norm(v1) = V(:,2)$, $v2/norm(v2) = -V(:,1)$ and $v3/norm(v3) = V(:,3)$.

. For **Problem 13** with

```
>> A = [ 1 -1 -1; 1 -1 0; 1 0 -1];
```

$$(a) \det(A - \lambda I) = \begin{vmatrix} 1-\lambda & -1 & -1 \\ 1 & -1-\lambda & 0 \\ 1 & 0 & -1-\lambda \end{vmatrix} \xrightarrow{R_3+(-1-\lambda)R_1} \begin{vmatrix} 1-\lambda & -1 & -1 \\ 1 & -1-\lambda & 0 \\ \lambda^2 & 1+\lambda & 0 \end{vmatrix} =$$

$$(-1)(1+\lambda) \begin{vmatrix} 1 & -1 \\ \lambda^2 & 1 \end{vmatrix} = (-1-\lambda)(\lambda^2+1) \text{ where we have used row operations, expansion along}$$

row 1, and factored out $(-1-\lambda)$ from column 3 (after the expansion). Note this gives the characteristic polynomial in (easily) factored form.

```

>> [n,n]=size(A); c=(-1)^n*poly(A)
c =
   -1.0000   -1.0000   -1.0000   -1.0000

```

(b) The roots are $\lambda_1 = -1$, $\lambda_2 = i$ and $\lambda_3 = -i$.

```
>> r=roots(c)
r =
-1.0000
 0.0000 + 1.0000i
 0.0000 - 1.0000i
```

(c)

```
>> rref(A-(-1)*eye(n)) %We use the exact eigenvalues instead of r(i)
ans =
 1 0 0
 0 1 1
 0 0 0
>> % So let x3=1, and solve to get an eigenvector for -1 as the transpose of
>> v1 = [-ans(1,3) -ans(2,3) 1]
v1 =
 0 -1 1
>> rref(A-(i)*eye(n))
ans =
 1.0000 0 -1.0000 - 1.0000i
 0 1.0000 -1.0000
 0 0 0
>> % So let x3=1, and solve to get an eigenvector for i as the transpose of
>> v2 = [-ans(1,3) -ans(2,3) 1]
v2 =
 1.0000 + 1.0000i 1.0000 1.0000
>> rref(A-(-i)*eye(n))
ans =
 1.0000 0 -1.0000 + 1.0000i
 0 1.0000 -1.0000
 0 0 0
>> % So let x3=1, and solve to get an eigenvector for -i as the transpose of
>> v3 = [-ans(1,3) -ans(2,3) 1]
v3 =
 1.0000 - 1.0000i 1.0000 1.0000
```

(d) The three eigenvalues in (b) are distinct.

```
>> rref([v1.' v2.' v3.']) % This is I so columns are independent.
ans =
 1 0 0
 0 1 0
 0 0 1
```

(e)

```
>> [V,D] = eig(A)
V =
 0.5000 - 0.5000i 0.5000 + 0.5000i 0.0000
 0 - 0.5000i 0 + 0.5000i -0.7071
 0 - 0.5000i 0 + 0.5000i 0.7071
D =
 0.0000 + 1.0000i 0 0
 0 0.0000 - 1.0000i 0
 0 0 -1.0000
>> % Note the elements in r appear in a different order along the diagonal of D
```

```

>> % If zeros follow, V(:,k) is eigenvector for D(k,k)
>> for k = 1:n , (A-D(k,k)*eye(n))*V(:,k), end
ans =
    1.0e-15 *
         0 - 0.2220i
    0.1665 + 0.0555i
         0 + 0.2220i
ans =
    1.0e-15 *
         0 + 0.2220i
    0.1665 - 0.0555i
         0 - 0.2220i
ans =
    1.0e-15 *
    0.1110
    0.2355
    0.0785

>> V\[v2./norm(v2) v3./norm(v3) v1./norm(v1)] % Match order of eigenvalues
ans =
    0 + 1.0000i    0.0000 + 0.0000i    0.0000 - 0.0000i
    0.0000 - 0.0000i         0 - 1.0000i    0.0000 + 0.0000i
    0.0000 - 0.0000i    0.0000 + 0.0000i    1.0000

```

This last diagonal matrix shows $v2/\text{norm}(v2) = i V(:,1)$, $v3/\text{norm}(v3) = -i V(:,2)$ and $v1/\text{norm}(v1) = V(:,3)$.

4.

```
>> A = [ 1 2 2 ; 0 2 1 ; -1 2 2];
```

$$(a) \det(A - \lambda I) = \begin{vmatrix} 1-\lambda & 2 & 2 \\ 0 & 2-\lambda & 1 \\ -1 & 2 & 2-\lambda \end{vmatrix} \stackrel{R_1+(1-\lambda)R_3}{=} \begin{vmatrix} 0 & 4-2\lambda & 4-3\lambda+\lambda^2 \\ 0 & 2-\lambda & 1 \\ -1 & 2 & 2-\lambda \end{vmatrix} =$$

$$(-1)(2-\lambda) \begin{vmatrix} 2 & 4-3\lambda+\lambda^2 \\ 1 & 1 \end{vmatrix} = (\lambda-2)(-\lambda^2+3\lambda^2-2) = -(\lambda-2)^2(\lambda-1) \text{ where we have used}$$

row operations, expansion along row 1, and factored out $(2-\lambda)$ from column 2 (after the expansion). Note this gives the characteristic polynomial in factored form. Computing $\text{rref}(A-I)$ and $\text{rref}(A-2I)$ and solving the associated homogeneous equations yields $(-x_3, -x_3, x_3)^t$, $x_3 \neq 0$, as the eigenvectors for $\lambda = 1$ and $(2x_2, x_2, 0)^t$, $x_2 \neq 0$ as the eigenvectors for $\lambda = 2$. Since there is only one free variable in the description of this latter set of eigenvectors, $\lambda = 2$ has geometric multiplicity 1.

(b)

```

>> c=poly(A) % Since n=3, multiplying this by -1 will give coefficients in (a)
c =
    1.0000   -5.0000    8.0000   -4.0000
>> format long
>> r=roots(c)
r =
  2.000000000000000 + 0.000000094993481i
  2.000000000000000 - 0.000000094993481i
  1.000000000000000

```

Note that the computed roots almost find the repeated eigenvalue, 2, but not exactly. In fact the computed roots even have small imaginary parts.

```
>> format long
>> rref(A-r(1)*eye(3))
ans =
     1     0     0
     0     1     0
     0     0     1
```

Note the result here says $A - r(1)I$ is not singular, so $r(1)$ is not an exact eigenvalue and we can not use the reduced echelon form to find even an approximate eigenvector. (The only solution to $Ax = r(1)x$ is $x = 0$, and 0 is never an eigenvector.) Repeating this with `rref(A-r(2)*eye(3))` will have similar results. We will need to use the exact eigenvalue 2, and find `rref(A-2*eye(3))` to compute the eigenvectors.

```
>> format long
>> rref(A-r(3)*eye(3))
ans =
 1.0000000000000000      0  1.0000000000000000
                    0  1.0000000000000000  1.0000000000000000
                    0      0      0
>> v = [-ans(1,3) -ans(2,3) 1] % Row of zeros above, so can solve with x3=1
v =
-1.0000000000000000 -1.0000000000000000  1.0000000000000000
>> (A-r(3)*eye(3))*v.' % Approximately zero, so have an eigenvector for 1
ans =
 1.0e-14 *
 0.02220446049250
-0.11102230246252
 0
```

(c)

```
>> format long
>> [V,D]=eig(A)
V =
 0.89442719099992  0.89442719099992  0.57735026918963
 0.44721359549996  0.44721359549996  0.57735026918963
-0.00000002638784  0.00000002638784 -0.57735026918962
D =
 1.99999994099500      0      0
                    0  2.00000005900500      0
                    0      0  1.0000000000000000
>> diag(D)-[2 2 1]' % Differences between computed and true eigenvalues
ans =
 1.0e-07 *
-0.59004999108936
 0.59005000885293
 0.00000001998401
>> r - [2 2 1]'
ans =
 1.0e-07 *
 0.0000000888178 + 0.94993475941710i
 0.0000000888178 - 0.94993475941710i
-0.00000002109424
```

Note that the computed eigenvalues from D are at least real, and that they differ from the true eigenvalues by (a bit) less than the computed roots r do. Also you might say that since the diagonals in D are real, as are the true eigenvalues, these are “better” approximations than the complex entries in r .

(d)

```
>> for k=1:3, (A-D(k,k)*eye(3))*V(:,k), end
ans =
    1.0e-15 *
    -0.0278
    -0.3467
    -0.8909
ans =
    1.0e-14 *
    -0.0302
    -0.0446
    -0.1002
ans =
    1.0e-15 *
    0.8882
    -0.1110
    0
```

Each of the above is almost 0 and so says $A * V(:, k) \approx D(k, k) * V(:, k)$, which says the eigenvector, eigenvalue definition is approximately satisfied.

```
>> rref(V) % This gives I, so columns of V independent.
ans =
    1    0    0
    0    1    0
    0    0    1
```

If the columns of V were true eigenvectors this would show $\lambda = 2$ had geometric multiplicity 2. However, V above shows that the first two columns are (virtually) the same up to terms of order 10^{-7} . Thus they are “nearly” dependent.

- (e) Moving the graph down removes the intersection near $\lambda = 2$, while moving it up changes the single intersection into two intersections. The approximations from the diagonal entries of D had two real values close to 2, corresponding to moving the graph up, while r has two complex values close to 2, corresponding to moving the graph down.

5. (a)

```
>> A = [ 3 2 ; -5 1]; % Matrix from Problem 6
>> poly(A)-poly(A') % Essentially zero
ans =
    0    0    0
>> A = [ 1 1 -2; -1 2 1; 0 1 -1]; % Matrix from Problem 8
>> poly(A)-poly(A') % Essentially zero
ans =
    1.0e-14 *
    0   -0.3775   0.3553   0.1998
>> A = [-3 -7 -5; 2 4 3 ; 1 2 2]; % Matrix from Problem 12
>> poly(A)-poly(A') % Essentially zero
ans =
    1.0e-14 *
    0   -0.3553    0   -0.2554
```

```

>> A = [ 1 -1 -1; 1 -1 0; 1 0 -1]; % Matrix from Problem 13
>> poly(A)-poly(A')           % Essentially zero
ans =
     0     0     0     0
>> A = [4 1 0 1; 2 3 0 1; -2 1 2 -3; 2 -1 0 5]; % Problem 16
>> poly(A)-poly(A')           % Essentially zero
ans =
 1.0e-13 *
     0   -0.0355   0.2842  -0.8527   0.7105

```

Conjecture: The characteristic polynomials of A and A^t are the same. (Note that the computations above actually relate to $(-1)^n$ times the characteristic polynomial, when A is $n \times n$.)

- (b) $\det(A - \lambda I) = \det((A - \lambda I)^t)$ since $\det(C) = \det(C^t)$ for any C . But $(A - \lambda I)^t = A^t - (\lambda I)^t = A^t - \lambda I$ since λI is diagonal. Combining with the first equality, this yields $\det(A - \lambda I) = \det(A^t - \lambda I)$, which is exactly the conjectured equality.

6. (a)

```

>> A=10*(2*rand(4,4)-ones(4,4)); % A random 4x4 matrix
>> A(:,3) = 2*A(:,1)-A(:,2); % Make A non-invertible
>> d=eig(A)
d =
 -5.2819 +15.0578i
 -5.2819 -15.0578i
  7.7290
  0.0000

```

Notice that 0 occurs as an (approximate) eigenvalue of each A . This is to be expected as the noninvertibility of A is equivalent to the existence of a nontrivial solution to $Ax = 0$. Such a solution is an eigenvector for the eigenvalue 0.

(b) (i)

```

>> A = [-2 -2 ; -5 1]; % For Problem 1
>> d=eig(A), e=eig(inv(A))
d =
    -4
     3
e =
 -0.2500
  0.3333

>> A = [-12 7; -7 2]; % For Problem 2
>> d=eig(A), e=eig(inv(A))
d =
    -5
    -5
e =
 -0.2000
 -0.2000

```

```

>> A = [1 1 -2; -1 2 1 ; 0 1 -1];      % For Problem 8
>> d=eig(A), e=eig(inv(A))
d =
    1.0000
    2.0000
   -1.0000
e =
    1.0000
   -1.0000
    0.5000

>> A=[3 9.5 -2 -10.5; -10 -42.5 10 44.5; 6 23.5 -5 -24.5; -10 -43 10 45];
>> d=eig(A), e=eig(inv(A))
d =
   -3.0000
    2.0000
    1.0000
    0.5000
e =
   -0.3333
    0.5000
    1.0000
    2.0000

```

(ii) In each of the examples the entries in e are the reciprocals (inverses) of the entries in d . Thus the conjecture is the statement: If λ is an eigenvalue for A , then $1/\lambda$ is an eigenvalue for A^{-1} (or possibly this plus its' converse, i.e. λ is an eigenvalue for A if and only if $1/\lambda$ is an eigenvalue for A^{-1}).

(iii)

```

>> A=[2 -1; 5 -2]; % For problem 3
>> d=eig(A)
d =
    0 + 1.0000i
    0 - 1.0000i
>> ones(2,1)./eig(inv(A)) % Same as d after some reordering
ans =
    0 - 1.0000i
    0 + 1.0000i

>> A = [ 3 2 ; -5 1]; % For Problem 6
>> d=eig(A)
d =
    2.0000 + 3.0000i
    2.0000 - 3.0000i
>> ones(2,1)./eig(inv(A)) % Same as d after some reordering
ans =
    2.0000 - 3.0000i
    2.0000 + 3.0000i

```

```

>> A = [ 1 -1 -1; 1 -1 0; 1 0 -1]; % Matrix from Problem 13
>> d=eig(A)
d =
    0.0000 + 1.0000i
    0.0000 - 1.0000i
   -1.0000
>> ones(3,1)./eig(inv(A))    % Same as d after some reordering
ans =
    0.0000 - 1.0000i
    0.0000 + 1.0000i
   -1.0000

```

- (c) In what follows we use an “exact” value for the eigenvalue for A and A^{-1} rather than the computed approximations $d(i)$ and the corresponding $e(j)$ since the use of `rref(A-cI)` for finding eigenvectors is very sensitive to roundoff errors.

```

>> A = [-2 -2 ; -5 1]; % For Problem 1 choose eigenvalue 3
>> rref(A-3*eye(2)),rref(inv(A)-(1/3)*eye(2))
ans =
    1.0000    0.4000
         0         0
ans =
    1.0000    0.4000
         0         0

>> A=[ -12 7; -7 2]; % For Problem 2 choose eigenvalue -5
>> rref(A-(-5)*eye(2)),rref(inv(A)-(1/(-5))*eye(2))
ans =
     1     -1
     0      0
ans =
     1     -1
     0      0

>> A=[2 -1; 5 -2]; % For Problem 3 choose eigenvalue i
>> rref(A-i*eye(2)),rref(inv(A)-(1/i)*eye(2))
ans =
    1.0000    -0.4000 - 0.2000i
         0         0
ans =
    1.0000    -0.4000 - 0.2000i
         0         0

>> A = [ 3 2 ; -5 1]; % For Problem 6 choose 2+3i
>> rref(A-(2+3*i)*eye(2)),rref(inv(A)-(1/(2+3*i))*eye(2))
ans =
    1.0000    0.2000 + 0.6000i
         0         0
Warning: Divide by zero
ans =
    1.0000    0.2000 + 0.6000i
         0         0

```



```

>> A = [1 1 -2; -1 2 1; 0 1 -1]; % For Problem 8 choose eigenvalue 2
>> rref(A-2*eye(3)),rref(inv(A)-(1/2)*eye(3))
ans =
     1     0     -1
     0     1     -3
     0     0     0
ans =
     1     0     -1
     0     1     -3
     0     0     0

>> A = [1 -1 -1; 1 -1 0; 1 0 -1]; % For Problem 13, eigenvalue i
>> rref(A-i*eye(3)),rref(inv(A)-(1/i)*eye(3))
ans =
  1.0000         0   -1.0000 - 1.0000i
         0   1.0000   -1.0000
         0         0         0
ans =
  1.0000         0   -1.0000 - 1.0000i
         0   1.0000   -1.0000
         0         0         0

>> A=[3 9.5 -2 -10.5; -10 -42.5 10 44.5; 6 23.5 -5 -24.5; -10 -43 10 45];
>> % For the extra matrix in (b)(i), and eigenvalue -3.
>> rref(A-(-3)*eye(4)),rref(inv(A)-(1/(-3))*eye(4))
ans =
  1.0000         0         0         0
         0   1.0000         0   -1.0000
         0         0   1.0000   0.5000
         0         0         0         0
ans =
  1.0000         0         0   0.0000
         0   1.0000         0   -1.0000
         0         0   1.0000   0.5000
         0         0         0         0

```

In each case $\text{rref}(A-\lambda I) = \text{rref}(\text{inv}(A)-(1/\lambda)I)$. Thus the eigenvectors for A for the eigenvalue λ and the eigenvectors for A^{-1} for the eigenvalue $1/\lambda$ are the same.

- (d) For an invertible matrix A , λ is an eigenvalue if and only if $1/\lambda$ is an eigenvalue for A^{-1} . Moreover \mathbf{v} is an eigenvector for A (for λ) if and only if \mathbf{v} is an eigenvector for A^{-1} (for $1/\lambda$). To see this is true suppose \mathbf{v} is an eigenvector for A for the eigenvalue λ . Then $AA^{-1} = I = A^{-1}A$, so $\mathbf{v} = A^{-1}A\mathbf{v} = A^{-1}(\lambda\mathbf{v}) = \lambda A^{-1}\mathbf{v}$. Dividing by λ shows \mathbf{v} is an eigenvector for A^{-1} for the eigenvalue $1/\lambda$. Conversely, if \mathbf{v} is an eigenvector for A^{-1} for $1/\lambda$, then the previous equality holds. Multiplying it by A yields $A\mathbf{v} = \lambda AA^{-1}\mathbf{v} = \lambda\mathbf{v}$, i.e. \mathbf{v} is an eigenvector for A for the eigenvalue λ .

7. Following parts (b) to (d) of previous problem for A^2 .

(b) (i)

```

>> A = [-2 -2 ; -5 1]; % For Problem 1
>> d=eig(A), e=eig(A^2)
d =
   -4
    3
e =
   16
    9

```

```

>> A = [-12 7; -7 2];      % For Problem 2
>> d=eig(A), e=eig(A^2)
d =
    -5
    -5
e =
    25
    25

>> A = [1 1 -2; -1 2 1 ; 0 1 -1];      % For Problem 8
>> d=eig(A), e=eig(A^2)
d =
    1.0000
    2.0000
   -1.0000
e =
     1
     4
     1

>> A=[3 9.5 -2 -10.5; -10 -42.5 10 44.5; 6 23.5 -5 -24.5; -10 -43 10 45];
>> d=eig(A), e=eig(A^2)
d =
   -3.0000
    2.0000
    1.0000
    0.5000
e =
    9.0000
    4.0000
    1.0000
    0.2500

```

- (ii) In each of the examples the square of each entry in \mathbf{d} appears in \mathbf{e} . Thus the simple conjecture is the statement: If λ is an eigenvalue for A , then λ^2 is an eigenvalue for A^2 . (Note that it is also true the each entry in \mathbf{e} is the square of some entry in \mathbf{d} , so we might make the additional conjecture that if μ is an eigenvalue for A^2 , then $\mu = \lambda^2$ for some eigenvalue λ for A .)

(iii)

```

>> A=[2 -1; 5 -2]; % For problem 3
>> eig(A).^2, eig(A^2) % Both ans have the same entries, in some order
ans =
    -1
    -1
ans =
    -1
    -1

>> A=[3 2 ; -5 1]; % For Problem 6
>> eig(A).^2, eig(A^2) % Both ans have the same entries, in some order
ans =
   -5.0000 +12.0000i
   -5.0000 -12.0000i
ans =
   -5.0000 +12.0000i
   -5.0000 -12.0000i

```

```

>> A = [ 1 -1 -1; 1 -1 0; 1 0 -1]; % Matrix from Problem 13
>> eig(A).^2,eig(A^2)           % Both ans have the same entries, in some order
ans =
    -1.0000 + 0.0000i
    -1.0000 - 0.0000i
     1.0000
ans =
    -1.0000
    -1.0000
     1.0000

```

(c)

```

>> A = [-2 -2 ; -5 1]; % For Problem 1 choose eigenvalue -4
>> rref(A-(-4)*eye(2)),rref(A^2-(-4)^2*eye(2))
ans =
     1     -1
     0      0
ans =
     1     -1
     0      0

>> A=[ -12 7; -7 2]; % For Problem 2 choose eigenvalue -5
>> rref(A-(-5)*eye(2)),rref(A^2-(-5)^2*eye(2))
ans =
     1     -1
     0      0
ans =
     1     -1
     0      0

>> A=[2 -1; 5 -2]; % For Problem 3 choose -i
>> rref(A-(-i)*eye(2)),rref(A^2-(-i)^2*eye(2))
ans =
    1.0000          -0.4000 + 0.2000i
         0              0
Warning: Divide by zero
ans =
     1      0
     0      1

```

Again there is some computational difficulty, since there are no rows of zeros in $\text{rref}(A^2 - (-i)^2 I)$. This seems quite strange since $A^2 + I = O$. The cause is our use of the power function, '^', which can be subject to roundoff error in its passage to polar coordinates. (Try computing $i^2 + 1$ in MATLAB.) If we stick to multiplication for squaring everything is fine:

```

>> rref(A^2-(-i)*(-i)*eye(2))
ans =
     0      0
     0      0

```

Now we note the different reduced echelon forms. However, every solution to $(A + iI)v = 0$ also solves $(A^2 + I)v = 0$, since every vector solves the later equation.

```
>> A = [ 3 2 ; -5 1]; % For Problem 6 choose 2-3i
>> rref(A-(2-3*i)*eye(2)),rref(A^2-(2-3*i)^2*eye(2))
ans =
    1.0000          0.2000 - 0.6000i
         0              0
ans =
    1.0000          0.2000 - 0.6000i
         0              0
```

```
>> A = [1 1 -2; -1 2 1 ; 0 1 -1]; % For Problem 8 choose -1
>> rref(A-(-1)*eye(3)),rref(A^2-(-1)^2*eye(3))
ans =
     1     0    -1
     0     1     0
     0     0     0
ans =
     1    -1    -1
     0     0     0
     0     0     0
```

Again note that the reduced forms are different. However, any vector in the nullspace of the first is also in nullspace of the second, since the rows of the second echelon form are linear combinations of the rows of the first.

```
>> A = [ 1 -1 -1; 1 -1 0; 1 0 -1];
>> % For Problem 13 choose i
>> rref(A-i*eye(3)),rref(A^2-i*i*eye(3)) % i*i instead of i^2 for accuracy.
ans =
    1.0000          0          -1.0000 - 1.0000i
         0          1.0000          -1.0000
         0          0          0
ans =
     0     1    -1
     0     0     0
     0     0     0
```

Here too the reduced echelon forms differ, though again each row of the second is a linear combination of rows of the first.

```
>> A=[3 9.5 -2 -10.5; -10 -42.5 10 44.5; 6 23.5 -5 -24.5; -10 -43 10 45];
>> d=eig(A), e=eig(A^2) % For the extra matrix in Matlab Problem 6(b)(i)
d =
   -3.0000
    2.0000
    1.0000
    0.5000
e =
   9.0000
   4.0000
   1.0000
   0.2500
```

```
>> rref(A-(-3)*eye(4)),rref(A^2-(-3)^2*eye(4))
ans =
    1.0000         0         0         0
         0    1.0000         0   -1.0000
         0         0    1.0000    0.5000
         0         0         0         0
ans =
    1.0000         0         0         0
         0    1.0000         0   -1.0000
         0         0    1.0000    0.5000
         0         0         0         0
```

In most cases $\text{rref}(A-\lambda I) = \text{rref}(A^2-\lambda^2 I)$. However in some cases all that is true is that every row of $\text{rref}(A^2-\lambda^2 I)$ is a linear combination of rows of $\text{rref}(A-\lambda I)$. But this means that in all cases the eigenvectors for A for the eigenvalue λ (the nullspace of $A-\lambda I$), are eigenvectors for A^2 for the eigenvalue λ^2 .

- (d) If \mathbf{v} is an eigenvector for A (for λ) then \mathbf{v} is an eigenvector for A^2 (for λ^2). The proof is just the observation that $A^2\mathbf{v} = A(A\mathbf{v}) = A(\lambda\mathbf{v}) = \lambda A\mathbf{v} = \lambda(\lambda\mathbf{v})$, by linearity and the definition of an eigenvector. (It is harder to prove the (true) statement: Every eigenvalue for A^2 is the square of an eigenvalue for A . See the solution to 6.1, Problem 27.)

8.

```
>> A = [ 3 2 ; -5 1];           % For Problem 6
>> C=rand(2); B=C*A*inv(C);    % For Matlab 3.5 could use rand(A)
>> eig(A),eig(B)               % For Matlab 4.x rand(size(A))
ans =
    2.0000 + 3.0000i
    2.0000 - 3.0000i
ans =
    2.0000 + 3.0000i
    2.0000 - 3.0000i

>> A = [1 1 -2; -1 2 1 ; 0 1 -1]; % For Problem 8
>> C=rand(3); B=C*A*inv(C);
>> eig(A),eig(B)
ans =
    1.0000
    2.0000
   -1.0000
ans =
   -1.0000
    1.0000
    2.0000

>> A = [ 1 -1 0; -1 2 -1; 0 -1 1]; % For Problem 7
>> C=rand(3); B=C*A*inv(C);
>> eig(A),eig(B)
ans =
    0.0000
    1.0000
    3.0000
ans =
    3.0000
    0.0000
    1.0000
```

```

>> A = [ 1 -1 -1; 1 -1 0; 1 0 -1]; % For Problem 13
>> C=rand(size(A)); B=C*A*inv(C); % Use rand (A) in MATLAB 3.5.
>> eig(A),eig(B)
ans =
    0.0000 + 1.0000i
    0.0000 - 1.0000i
   -1.0000
ans =
    0.0000 + 1.0000i
    0.0000 - 1.0000i
   -1.0000

```

In each case the eigenvalues of A and CAC^{-1} are the same, up to a reordering.

9. (a)

```

>> B=10*(2*rand(3)-ones(3,3)); A=triu(B)+triu(B)' % A random symmetric 3x3.
A =
  -11.2416    3.5859    0.3883
    3.5859   17.3877    6.6193
    0.3883    6.6193  -18.6171
>> eig(A)
ans =
  -11.6626
  -19.8028
   18.9944

```

All the eigenvalues of a symmetric matrix are real.

(b)

```

>> A=10*(2*rand(3,3)-ones(3,3)); C = A*A'
C =
   44.6033   84.6656  -32.0771
   84.6656  201.4658 -114.2796
  -32.0771 -114.2796  104.8750
>> eig(C)
ans =
    1.6642
   42.1828
  307.0971

>> A=10*(2*rand(4,3)-ones(4,3)); C = A*A'
C =
   88.3621   30.2144  -14.4017   80.1812
   30.2144  149.5133   75.9310  -33.5730
  -14.4017   75.9310   62.3729  -36.1387
   80.1812  -33.5730  -36.1387  111.1881
>> eig(C)
ans =
    0.0000
   20.6190
  171.7760
  219.0414

```

```
>> A=10*(2*rand(2,3)-ones(2,3)); C = A*A'
C =
  136.7648   11.1523
   11.1523   53.1666
>> eig(C)
ans =
  138.2270
   51.7044
```

Every eigenvalue of AA^t is nonnegative. If A has more rows than columns then AA^t has zero as an eigenvalue. (You might be tempted to conjecture that for A square, the eigenvalues of AA^t are actually positive, but that is not always true. If it occurred for your random A , it was connected with the fact that, in so far as possible, random A usually have as many independent columns as possible.)

10.

```
>> B=10*(2*rand(3)-ones(3,3)); A=triu(B)+triu(B)' % A random symmetric 3x3.
A =
 -11.2416   3.5859   0.3883
   3.5859  17.3877   6.6193
   0.3883   6.6193 -18.6171
>> [V,D]=eig(A) %The entries of D are all distinct
V =
 -0.9925  -0.0299   0.1182
   0.1111   0.1779   0.9778
   0.0503  -0.9836   0.1733
D =
 -11.6626   0   0
   0 -19.8028   0
   0   0  18.9944
>> V.'*V %If this is I then V has orthonormal columns
ans =
  1.0000   0.0000   0.0000
  0.0000   1.0000   0.0000
  0.0000   0.0000   1.0000
```

11. (a)

```
>> A=zeros(4,4); % Now put in 1's in row i in the "columns" connected to i.
>> A(1,[2 3 4])=[1 1 1];A(2,[1 3 4])=[1 1 1];
>> A(3,[1 2 4])=[1 1 1];A(4,[2 3 4])=[1 1 1];
>> lambda = eig(A)
lambda =
 -1.0000
   0
   3.0000
 -1.0000
>> lb = 1-max(lambda)/min(lambda) % The lower bound
lb =
  4.0000
>> ub = 1+max(lambda) % The upper bound
ub =
  4.0000
```

Since $lb = 4 \leq \chi \leq 4 = ub$, $\chi = 4$. Each of the 4 vertices needs a different color since each is connected to the other 3.

(b)

```
>> A=zeros(6,6); % Now put in 1's in row i in the "columns" connected to i.
>> A(1,[2 5 6])=[1 1 1];A(2,[1 3 6])=[1 1 1];
>> A(3,[2 4 6])=[1 1 1];A(4,[3 5 6])=[1 1 1];
>> A(5,[1 4 6])=[1 1 1];A(6,1:5)=[1 1 1 1 1];
>> lambda = eig(A)
lambda =
   -1.6180
    0.6180
   -1.6180
    0.6180
    3.4495
   -1.4495
>> lb = 1-max(lambda)/min(lambda) % The lower bound
lb =
    3.1319
>> ub = 1+max(lambda) % The upper bound
ub =
    4.4495
```

Since $3.13 \leq lb \leq \chi \leq ub \leq 4.45$, $\chi = 4$. Each triangle requires 3 different colors. If you try to color with just 3, then outer ring would have to be colored with 2 colors. But since there are an odd number of vertices in that ring two adjacent vertices would have the same color. So color 6 with one color, alternate two other colors around 1 to 4 and put a fourth color on 5.

(c)

```
>> A=zeros(5,5); % Now put in 1's in row i in the "columns" connected to i.
>> A(1,[2 4 5])=[1 1 1];A(2,[1 3 4 5])=[1 1 1 1];
>> A(3,[2 4 5])=[1 1 1];A(4,[1 2 3 5])=[1 1 1 1];
>> A(5,[1 2 3 4])=[1 1 1 1];
>> lambda = eig(A)
lambda =
   -1.0000
    0.0000
   -1.0000
   -1.6458
    3.6458
>> lb = 1-max(lambda)/min(lambda) % The lower bound
lb =
    3.2153
>> ub = 1+max(lambda) % The upper bound
ub =
    4.6458
```

Since $3.2 \leq lb \leq \chi \leq ub \leq 4.65$, $\chi = 4$. You need three colors for the 2-4-5 triangle. Then 1 and 3 need to be different from these three colors, as both are adjacent to those three vertices. However, 1 and 3 are not joined, so can be colored the same (fourth) color.

(d)

```

>> A=zeros(5,5); % Now put in 1's in row i in the "columns" connected to i.
>> A(1,[3 4])=[1 1];A(2,[4 5])=[1 1];
>> A(3,[1 5])=[1 1];A(4,[1 2])=[1 1];
>> A(5,[2 3])=[1 1];
>> lambda = eig(A)
lambda =
    0.6180
    0.6180
   -1.6180
   -1.6180
    2.0000
>> lb = 1-max(lambda)/min(lambda) % The lower bound
lb =
    2.2361
>> ub = 1+max(lambda) % The upper bound.
ub =
    3.0000

```

Since $2.23 \leq lb \leq \chi \leq ub = 3$, $\chi = 3$. Reordering, this is the ring 1-3-5-2-4-1. With an odd number of vertices it can not be colored with just two colors, but it can be colored with three colors, as in the outer ring of (b).

(e)

```

>> A=zeros(10,10); % Now put in 1's in row i in the "columns" connected to i.
>> A(1,[2 5 6])=[1 1 1];A(2,[1 3 7])=[1 1 1];
>> A(3,[2 4 8])=[1 1 1];A(4,[3 5 9])=[1 1 1];
>> A(5,[1 4 10])=[1 1 1];A(6,[1 8 9])=[1 1 1];
>> A(7,[2 9 10])=[1 1 1];A(8,[3 6 10])=[1 1 1];
>> A(9,[4 6 7])=[1 1 1];A(10,[5 7 8])=[1 1 1];
>> lambda = eig(A)
lambda =
    1.0000
    1.0000
    1.0000
    1.0000
    1.0000
   -2.0000
   -2.0000
   -2.0000
   -2.0000
    3.0000
>> lb = 1-max(lambda)/min(lambda) % The lower bound
lb =
    2.5000
>> ub = 1+max(lambda) % The upper bound
ub =
    4.0000

```

Since $2.5 = lb \leq \chi \leq ub = 4$, $\chi = 3$ or 4 . We show 3 will do. Color outer ring by using one color, say blue, for 1 and alternating two other colors, say red and green, around 2-3-4-5. If the inner star has the same three colors, one will appear at only one point, and then the other two will each color one side of the star. A little thought shows the single color must be either red or green, say red. Placing this at 9 and blue at 7,8 and green at 6,10 gives a three color coloring.

12. (a)

```

>> A = [-.01969633  .01057339  -.005030409;...
>>      .01057339  .008020058  -.006818069;...
>>      -.005030409  -.006818069  .01158627 ];
>> [V,D]=eig(A); maxext=max(diag(D)) , maxcomp=min(diag(D)),
maxext =
    0.0197
maxcomp =
   -0.0235
>> for k=1:3, if maxext==D(k,k), MaxExt1Dir=V(:,k),end,end
MaxExt1Dir =
   -0.2655
   -0.6526
    0.7097
>> for k=1:3, if maxcomp==D(k,k), MaxComp1Dir=V(:,k),end,end
MaxComp1Dir =
    0.9501
   -0.3022
    0.0776

>> A = [-.01470626  .01001909  -.004158314;...
>>      .01001901  .007722046  -.004482362;...
>>      -.004158314  -.004482362  .006984212];
>> [V,D]=eig(A); maxext=max(diag(D)) , maxcomp=min(diag(D)),
maxext =
    0.0154
maxcomp =
   -0.0187
>> for k=1:3, if maxext==D(k,k), MaxExt2Dir=V(:,k),end,end
MaxExt2Dir =
    0.3296
    0.7569
   -0.5643
>> for k=1:3, if maxcomp==D(k,k), MaxComp2Dir=V(:,k),end,end
MaxComp2Dir =
    0.9363
   -0.3388
    0.0923

```

(b) Since $[1 \ 0 \ 0]$ and any column of V from $\text{eig}(A)$ are unit vectors as A is symmetric, the following give the requested (bedding) angles in degrees:

```

>> acos([1 0 0]*MaxComp1Dir)*180/pi % Angle : Compression Axis - 1st A
ans =
    18.1801
>> acos([1 0 0]*MaxComp2Dir)*180/pi % Angle : Compression Axis - 2nd A
ans =
    20.5600

```

(c) The bedding angles computed in (b) were about 18° and 21° , so far from 45° .

Section 6.2

In 1-3 answers are generally given to 3 significant digits, though more were used to calculate the tables.

1. We have $A = \begin{pmatrix} 0 & 3 \\ 0.4 & 0.6 \end{pmatrix}$. The eigenvalues for $\lambda_1 = 1.44$ and $\lambda_2 = -0.836$, with corresponding eigenvectors $\mathbf{v}_1 = \begin{pmatrix} 2.08 \\ 1 \end{pmatrix}$ and $\mathbf{v}_2 = \begin{pmatrix} -3.57 \\ 1 \end{pmatrix}$. Solving $\mathbf{p}_0 = a_1\mathbf{v}_1 + a_2\mathbf{v}_2$ for a_1 and a_2 , we obtain $a_1 = 7.58$ and $a_2 = 4.42$. Using the equation $\mathbf{p}_n = a_1\lambda_1^n\mathbf{v}_1 + a_2\lambda_2^n\mathbf{v}_2$, we find

n	$p_{j,n}$	$p_{a,n}$	T_n	$p_{j,n}/p_{a,n}$	T_n/T_{n-1}
0	0	12	12	0	—
1	36	7	43	5.14	3.58
2	22	19	41	1.16	0.95
5	104	45	149	2.31	—
10	600	291	891	2.06	—
19	16,090	7,737	23,827	2.08	—
20	23,170	11,140	34,310	2.08	1.44

The long-term ratios of $p_{j,n}$ to $p_{a,n}$ and T_n to T_{n-1} are 2.08 and 1.44, respectively.

2. We have $A = \begin{pmatrix} 0 & 1 \\ 0.3 & 0.4 \end{pmatrix}$. The eigenvalues are $\lambda_1 = 0.783$ and $\lambda_2 = -0.383$, with corresponding eigenvectors $\mathbf{v}_1 = \begin{pmatrix} 1.28 \\ 1 \end{pmatrix}$ and $\mathbf{v}_2 = \begin{pmatrix} -2.61 \\ 1 \end{pmatrix}$. Solving $\mathbf{p}_0 = a_1\mathbf{v}_1 + a_2\mathbf{v}_2$ for a_1 and a_2 , we find $a_1 = 10.1$ and $a_2 = 4.94$. Using $\mathbf{p}_n = a_1\lambda_1^n\mathbf{v}_1 + a_2\lambda_2^n\mathbf{v}_2$, we obtain

n	$p_{j,n}$	$p_{a,n}$	T_n	$p_{j,n}/p_{a,n}$	T_n/T_{n-1}
0	0	15	15	0	—
1	15	6	21	2.5	1.4
2	6	7	13	1.67	0.619
5	4	3	7	1.33	—
10	1	1	2	1	—
19	0	0	0	—	—
20	0	0	0	—	—

The long-term ratios of $p_{j,n}$ to $p_{a,n}$ and T_n to T_{n-1} are 1.28 and 0.783, respectively. However, $\mathbf{p}_n \approx 0$ and $T_n \approx 0$ for large n .

3. As $A = \begin{pmatrix} 0 & 4 \\ 0.7 & 0.8 \end{pmatrix}$, the eigenvalues are $\lambda_1 = 2.12$ and $\lambda_2 = -1.32$, with corresponding eigenvectors $\mathbf{v}_1 = \begin{pmatrix} 1.89 \\ 1 \end{pmatrix}$ and $\mathbf{v}_2 = \begin{pmatrix} -3.03 \\ 1 \end{pmatrix}$. Solving $\mathbf{p}_0 = a_1\mathbf{v}_1 + a_2\mathbf{v}_2$ for a_1 and a_2 , we find $a_1 = 12.3$ and $a_2 = 7.68$. Using the equation $\mathbf{p}_n = a_1\lambda_1^n\mathbf{v}_1 + a_2\lambda_2^n\mathbf{v}_2$, we obtain

n	$p_{j,n}$	$p_{a,n}$	T_n	$p_{j,n}/p_{a,n}$	T_n/T_{n-1}
0	0	20	20	0	—
1	80	16	96	5	4.8
2	64	69	133	0.928	1.39
5	1092	498	1,590	2.19	—
10	42,412	22,807	65,219	1.86	—
19	3.69×10^7	1.95×10^7	5.64×10^7	1.89	—
20	7.82×10^7	4.14×10^7	11.96×10^7	1.89	2.13

The long-term ratios of $p_{j,n}$ to $p_{a,n}$ and T_n to T_{n-1} are 1.89 and 2.12, respectively.

4. For the population to increase in the long run, we need $k > (1-\alpha)/\alpha$. As $\alpha > 1/2$, then $1 > (1-\alpha)/\alpha$. Hence, if $k \geq 1$, then the population will increase.

5. From equation (9), $\mathbf{p}_n \approx a_1 \lambda_1^n \mathbf{v}_1$ for large n . Thus, if $\mathbf{v}_1 = \begin{pmatrix} x \\ y \end{pmatrix}$, then $p_{j,n}/p_{a,n} \approx a_1 \lambda_1^n x / a_1 \lambda_1^n y = x/y$.

As $\begin{pmatrix} -\lambda_1 & k \\ \alpha & \beta - \lambda_1 \end{pmatrix} \begin{pmatrix} x \\ y \end{pmatrix} = \begin{pmatrix} 0 \\ 0 \end{pmatrix}$, then $-\lambda_1 x + ky = 0$, and hence, $p_{j,n}/p_{a,n} \approx k/\lambda_1$ for large n .

6. Assume the number of male birds equals the number of female birds. Let $p_{j,n-1}$ denote the number of juvenile female birds in the $(n-1)$ st year, and let $p_{1,n-1}$ and $p_{2,n-1}$ denote the number of female birds in the $(n-1)$ st year for the first and second groups, respectively. Let α denote the proportion of juvenile female birds that will survive to become group 1 birds in the n^{th} year. Let $k_i, i = 1, 2$, denote the average number of female juvenile birds produced by each female bird of group i . In the n^{th} year, $\frac{1}{5}\beta p_{1,n-1}$ of the group 1 birds will become group 2 birds, and there will be $\alpha p_{j,n-1} +$

$\frac{4}{5}\beta p_{1,n-1}$ birds in group 1. Let $\mathbf{p}_n = \begin{pmatrix} p_{j,n} \\ p_{1,n} \\ p_{2,n} \end{pmatrix}$. Then $\mathbf{p}_n = A\mathbf{p}_{n-1}$, where $A = \begin{pmatrix} 0 & k_1 & k_2 \\ \alpha \frac{4}{5}\beta & 0 & \\ 0 & \frac{1}{5}\beta & \gamma \end{pmatrix}$, would

model the population growth of the birds. (Note the assumption that the second group is evenly distributed across the 1–5 year old range is impossible to achieve given that the only new members for the group are the 1 year olds, i.e. maturing juveniles, and that each year there is a uniform survival rate within the group.)

MATLAB 6.2

1.

```
>> A=[0 3 ; .4 .6] ; p0=[0 12].';
```

(a)

```
>> p2=A^2*p0 % Population at 2 years - take integer parts for realistic numbers
p2 =
    21.6000
    18.7200
>> p5=A^5*p0 % Population at 5 years
p5 =
    103.1616
    44.4787
>> p10=A^10*p0 % Population at 10 years
p10 =
    587.3774
    283.1110
>> p20=A^20*p0 % Population at 20 years
p20 =
    1.0e+04 *
    2.1965
    1.0513
```

If you compare these results to those given in the table for the solution to 6.2.1 you can see the 3-digit rounding used there resulted in overestimates for the populations.

(b)

```
>> p21=A^21*p0; p21(1)/p21(2) %Ratio of juveniles to adults after 21 years
ans =
    2.0895
>> sum(p21)/sum(p20) % Ratio of total population after 21 years to 20 years
ans =
    1.4358
>> p=zeros(2,5);p(:,1)=p21; % Put years 21-25 into one 2 x 5 matrix
>> % Each year requires multiplication by A; so fill p a column at a time by:
>> for k=2:5,p(:,k)=A*p(:,k-1); end
>> p(1,:)./p(2,:) % Ratio of juveniles to adults for years 21,...,25
ans =
    2.0895    2.0894    2.0895    2.0894    2.0895
>> T=sum(p) ; % sum(m by n) gives n column sums. So T is Total population
>> T(2:5)./T(1:4) % Ratio of Tn to T{n-1}, n=22,...,25
ans =
    1.4358    1.4358    1.4358    1.4358
```

It appears that $\lim_{n \rightarrow \infty} p_{j,n}/p_{a,n} = 2.0894\dots$ and $\lim_{n \rightarrow \infty} T_n/T_{n-1} = 1.4358\dots$, since the values computed for $n = 21, \dots, 25$ are stabilized at these values.

(c)

```
>> [V,D] = eig(A)
V =
   -0.9633   -0.9020
    0.2684   -0.4317
D =
   -0.8358     0
     0     1.4358
```

So largest magnitude is $D(2,2) = 1.4358 > 0$, with multiplicity 1. $v_2 = -V(:,2) = (0.9020, 0.4317)^t$ is an associated eigenvector with positive entries. $|D(1,1)| < D(2,2)$. Note that $D(2,2) \approx T_n/T_{n-1}$ which says $T_n \approx 1.4358T_{n-1}$, i.e. the total population is increasing by about 43.48 per cent each year.

```
>> w=-V(:,2) % An eigenvector associated with largest eigenvalue.
w =
    0.9020
    0.4317
>> w(1)/w(2)-p(1,5)/p(2,5) %
ans =
   -4.4094e-06
>> A(1,2)/D(2,2) - w(1)/w(2) % A(1,2) = k = Birth rate = 3 in this problem
ans =
     0
```

The long term ratio of juveniles to adults is equal to the birth rate divided by the largest eigenvalue, or to the ratio of the entries in the eigenvector for the largest eigenvalue.

2.

```
>> A=[0 3 ; .3 .15] ; p0=[0 12].';
```

(a)

```
>> [V,D] = eig(A)
V =
   -0.9599   -0.9461
    0.2805   -0.3238
D =
   -0.8766     0
     0     1.0266
```

We expect $\lim_{n \rightarrow \infty} T_n/T_{n-1} = 1.0266$, the largest eigenvalue. In fact $T_n = [1 \ 1]p_n = [1 \ 1]Ap_{n-1} \approx [1 \ 1]\lambda p_{n-1} = \lambda T_{n-1}$, since eventually all p_n are approximate eigenvectors for the largest eigenvalue $\lambda = 1.0266$. (See equation (9)). Also this fact about the eventual direction of p_n means that $\lim_{n \rightarrow \infty} p_{j,n}/p_{a,n} = k/\lambda = 3/1.0266 = 2.9223 (= V(1,2)/V(2,2) = A(1,2)/D(2,2))$.

(b)

```
>> p21=A^21*p0; %Ratio of juveniles to adults after 21 years
>> p=zeros(2,5);p(:,1)=p21; % Put years 21-25 into one 2 x 5 matrix
>> % Each year requires multiplication by A, thus we fill p a column at a time
>> for k=2:5,p(:,k)=A*p(:,k-1); end
>> p(1,:)./p(2,:) % Ratio of juveniles to adults for years 21,...,25
ans =
    3.1249    2.7587    3.0687    2.8021    3.0283
>> T=sum(p) ; % sum(m by n) gives n column sums. So T is Total population
>> T(2:5)./T(1:4) % Ratio of Tn to T{n-1}, n=22,...,25
ans =
    0.9909    1.0582    1.0005    1.0496
```

So both the ratios T_n/T_{n-1} and $p_{j,n}/p_{a,n}$ are still quite variable in the years 21 to 25 (the first changes nearly 13 per cent a year and the second nearly 5 per cent a year).

```
>> p=zeros(2,5);p(:,1)=A^46*p0; % Now put all years 46-50 into one 2 rowed matrix
>> for k=2:5,p(:,k)=A*p(:,k-1); end
>> p(1,:)./p(2,:) % Ratio of juveniles to adults for years 46,...,50
ans =
    2.9184    2.9254    2.9194    2.9245    2.9201
>> T=sum(p) ;
>> T(2:5)./T(1:4) % Ratio of Tn to T{n-1}, n=47,...,50
ans =
    1.0273    1.0260    1.0272    1.0262
```

For the years 46 to 50 the variation is down to at most .2 per cent a year.

- (c) The ratio of the absolute values of the smallest to largest eigenvalue in MATLAB problem one was $.8358/1.4358 = .5818$, while for the present problem the ratio is $.8766/1.0266 = .8539$. The convergence to a stable distribution is governed by equation (8) and requires that $(\lambda_2/\lambda_1)^n \rightarrow 0$. This approach to zero is very slow for a number like .8539, near 1, much more rapid for numbers like .58 which are closer to zero.

3.

```
>> A = [ 0 1 ; .6 .8]; p0=[100 200]'; % Growth matrix and initial deer population
```

- (a) Compute the (largest) eigenvalue for A:

```
>> [V,D]=eig(A)
V =
   -0.9044   -0.6181
    0.4267   -0.7861
D =
   -0.4718         0
         0    1.2718
```

The matrix has largest eigenvalue = 1.2718, and the other eigenvalue is strictly less in magnitude. Also there is an eigenvector for the largest eigenvalue with all components positive. Under these conditions we have seen that T_n/T_{n-1} approaches the largest eigenvalue, i.e. the long term growth rate is 1.27.

- (b) The only change in the model is that the adult population in the following year will be decreased by those adults from the previous year killed by hunting which is just h times the adult population. This simply modifies the matrix A by subtracting h from the adult survival rate, $A(2,2)$.
- (c)

```
>> AH=A; AH(2,2)=A(2,2)-.6;
>> [AH^10*p0 AH^20*p0 AH^30*p0 AH^40*p0 AH^50*p0]
ans =
   46.8229   13.5931    3.8386    1.0818    0.3048
   43.6535   12.0274    3.3830    0.9531    0.2685
>> [V,D]=eig(AH)
V =
   -0.8265   -0.7503
    0.5629   -0.6611
D =
   -0.6810         0
         0    0.8810
```

The components of the vectors $AH^n p_0$ get smaller and smaller, decreasing to zero. (By year 50, after rounding to integer values, there are no deer left.) Alternatively, note that the largest eigenvalue, representing the total population growth rate, is .8810, less than one, so eventually the total population goes down by about 12% a year; obviously this leads to eventual elimination.

(d)

```
>> AH(2,2)=A(2,2)-.3;    % Modify AH(2,2) for h=.3
>> [AH^10*p0 AH^20*p0 AH^30*p0 AH^40*p0]
ans =
    1.0e+03 *
    0.2925    0.5440    1.0111    1.8793
    0.3115    0.5788    1.0758    1.9994
>> max(max(eig(AH)))    % Largest eigenvalue > 1 , so explosive growth
ans =
    1.0639

>> AH(2,2)=A(2,2)-.5;    % Try h=.5
>> [AH^10*p0 AH^20*p0 AH^30*p0 AH^40*p0]
ans =
    88.3481    47.4730    25.2999    13.4808
    84.1617    44.5902    23.7564    12.6583
>> max(max(eig(AH)))    % Largest eigenvalue, still < 1, explaining decay
ans =
    0.9390

>> AH(2,2)=A(2,2)-.4;
>> [AH^10*p0 AH^20*p0 AH^30*p0 AH^40*p0]
ans =
    162.1221    162.4977    162.5000    162.5000
    162.7267    162.5014    162.5000    162.5000
>> max(max(eig(AH)))    % Largest eigenvalue = 1, so eventual steady state.
ans =
    1
```

For an h to determine a steady state, the largest eigenvalue must be one. Equation 10 in the text can be adapted to test for equality of the largest eigenvalue to 1 and becomes $k = (1 - \beta)/\alpha$. For the current problem this means h must satisfy $1 = (1 - .6)/(.8 - h)$ or $.8 - h = .4$, i.e. $h = .4$

- (e) The theory in the section (equation 9) shows that there will be growth if the largest eigenvalue is greater than 1, decay (extinction) if the largest eigenvalue is less than 1 and a steady state only if largest eigenvalue is one.

4.

```
>> A=[0 2 1 ; .6 0 0 ; 0 .6 .4]; p0 = [ 0 50 50]';
```

- (a) The first row coefficients are the birth rates for females for the three age classes, i.e. 1 to 5 year olds give birth to 2 per year, over 5 year olds give birth to 1 per year. The second row gives the proportion of each age group that survives and has age 1 to 5 after one year. (Notice the numbers mean .6 of the juveniles survive to 1 year, 0% of the 1 to 5 year olds survive and stay between 1 and 5 years old.) The bottom row gives the proportion of each group that survives and becomes over 5 years old in any one year. These interpretations shows this model matrix is not reasonable: After one year the only members of the 1 to 5 year old class will be 1 year old. In another year none of them can be over 5 years old, so it can't be that .6 of the 1-5 year olds become over 5. IF YOU WISH TO THINK OF THIS PROBLEM REALISTICALLY, change the middle group to be the class of 1 year olds and the upper class to be those 2 and over. To leave the group definitions unchanged it is necessary to change the model matrix entries.

(b)

```

>> p30=A^30*p0 % Distribution after 30 years.
p30 =
    1.0e+04 *
    9.0060
    4.2565
    2.9328
>> v=zeros(3,6);v(:,1)=p30; % Columns of v will be v30,v31,etc.
>> for k=2:6,v(:,k)=A^(29+k)*p0;end % Calculate the populations at 31-35
>> T=sum(v);T(2:6)./T(1:5) % sum the columns of v and take ratios
ans =
    1.2705    1.2701    1.2704    1.2702    1.2704
>> W=v*diag(ones(1,6)./T) % Columns of W are w30,w31,w32,etc.
W =
    0.5561    0.5563    0.5561    0.5562    0.5562    0.5562
    0.2628    0.2626    0.2628    0.2627    0.2627    0.2627
    0.1811    0.1811    0.1811    0.1811    0.1811    0.1811

```

Since entries in \mathbf{v}_n are all nonnegative, the entries in \mathbf{w}_n , $\mathbf{v}_n(i)/\text{sum}(\mathbf{v}_n)$, are exactly the proportion of \mathbf{v}_n in the i 'th entry. $\lim_{n \rightarrow \infty} T_n/T_{n-1} = 1.2705$ from the results for years 31-35; thus it appears the total population is growing at about 27 per cent per year. Also $\lim_{n \rightarrow \infty} \mathbf{w}_n = (.5562, .2627, .1811)^t$ and the entries give the eventual proportions of juveniles, 1 to 5 year olds, and over 5 year olds in the population. Thus even though the populations are growing, the proportions are not changing.

(c)

```

>> [V,D]=eig(A) % D(2,2) is the largest eigenvalue, it is greater than 1
V =
    0.8281   -0.8674   -0.0730
   -0.5133   -0.4097   -0.4489
    0.2252   -0.2825    0.8906
D =
   -0.9679         0         0
         0    1.2703         0
         0         0    0.0976
>> z=-V(:,2) % An eigenvector for D(2,2) with all positive elements
z =
    0.8674
    0.4097
    0.2825

>> zz=z/sum(z)
zz =
    0.5562
    0.2627
    0.1811
>> T(6)/T(5) - D(2,2) , zz-W(:,6) % Differences close to zero as expected
ans =
    7.4247e-05
ans =
    1.0e-04 *
   -0.2471
    0.3067
   -0.0596

```

The conclusion is that the vector of eventual proportions of each age class agrees with the proportions of the entries in the eigenvector for the largest eigenvalue.

- (e) Again equation 9 justifies the result about $T(n)/T(n-1)$ and also the conclusion that the direction of \mathbf{v}_n should coincide with the direction of the positive eigenvector for the largest eigenvalue. Specifically, $\mathbf{p}_n/[1 \ 1 \ 1]\mathbf{p}_n \approx a_1\lambda^n\mathbf{v}_1/(a_1\lambda^n[1 \ 1 \ 1]\mathbf{v}_n) = \mathbf{v}_1/[1 \ 1 \ 1]\mathbf{v}_1$.

5.

```
>> P=[.8 .2 .05; .05 .75 .05; .15 .05 .9];
```

- (a) (See MATLAB 1.6 solutions to problem 14 for details. Here are interpretations) The i^{th} component of $P^n\mathbf{x}$ represents the number of households buying product i after n months. As n gets larger, $P^n\mathbf{x}$ seems to be getting closer and closer to a fixed vector, $(900 \ 500 \ 1600)^t$, implying that the market share of each product stabilizes over time.

(b)

```
>> [V,D]=eig(P) % This has D(1,1) = 1 as largest eigenvalue, V(:,1) all positive
V =
    0.4730    0.7071    0.8018
    0.2628    0.0000   -0.2673
    0.8409   -0.7071   -0.5345
D =
    1.0000         0         0
         0    0.7500         0
         0         0    0.7000
```

Any initial starting vector \mathbf{x} with all positive entries will have a nonzero component in the direction of the eigenvector for the largest eigenvalue, since

$$0 < (1 \ 1 \ 1)\mathbf{x} = (1 \ 1 \ 1)(a_1V(:,1) + a_2V(:,2) + a_3V(:,3)) = a_1 + 0 + 0$$

for any such vector. Now extend the discussion leading to equation (9) to \mathbb{R}^3 , to conclude that when $\lambda_1 = 1$ is the largest magnitude of an eigenvalue, then $P^n\mathbf{x}$ will approach some fixed multiple of the eigenvector, \mathbf{v}_1 . In the present case this will approach the limit $\mathbf{y} = a_1\mathbf{v}_1 = ((1 \ 1 \ 1)\mathbf{x})\mathbf{v}_1 = 3000\mathbf{v}_1$ since $\mathbf{x} = (1000, 1000, 1000)^t$. (In general if the eigenvector \mathbf{v}_1 had not satisfied $(1 \ 1 \ 1)\mathbf{v}_1 = 1$, then it would have to be replaced by $\mathbf{z} = \mathbf{v}_1/\text{sum}(\mathbf{v}_1)$, an eigenvector normalized so that the components sum to 1). The limit vector has components which represent the long term distribution of households which will be buying a given product each month.

(c)

```
>> P=[.8 .1 .1; .05 .75 .1; .15 .15 .8]; % Pij = proportion of cars rented at
>>                                     % office j returned to office i.
>> [V,D]=eig(P) % D(1,1) = 1 is the largest eigenvalue.
V =
   -0.5623   -0.7071    0.0000
   -0.4016    0.7071   -0.7071
   -0.7229    0.0000    0.7071
D =
    1.0000         0         0
         0    0.7000         0
         0         0    0.6500
>> w=V(:,1)/sum(V(:,1)); 1000*w
ans =
    333.3333
    238.0952
    428.5714
```

Since $V(:,1)$ is an eigenvector associated with the eigenvalue 1, $1000w$ will give you a vector in the direction of the eigenvector whose components add to 1000 (the total number of cars). This vector represents the long term distribution of cars at each office: approximately 333 cars at office 1, 238 cars at office 2, and 429 cars at office 3.

(d) The multiplication $P^t \begin{pmatrix} 1 \\ 1 \\ 1 \end{pmatrix}$ yields the three row sums of P^t which are each one, since the rows

of P^t are the transposes of the columns of P . But $P^t \begin{pmatrix} 1 \\ 1 \\ 1 \end{pmatrix} = \begin{pmatrix} 1 \\ 1 \\ 1 \end{pmatrix}$ says one is an eigenvalue for

P^t (with eigenvector $\begin{pmatrix} 1 \\ 1 \\ 1 \end{pmatrix}$). Thus one is an eigenvalue for P . (Compare with 6.1, Problem 34,

or see MATLAB 6.1, Problem 5(b)). If one is the largest eigenvalue for P , then as in part (b), above, we expect $P^n \mathbf{x}_0$ to converge to an eigenvector for P for the eigenvalue one, which will represent the long term distribution of the starting distribution \mathbf{x}_0 evolving according to the transition probabilities given in the (columns) of the stochastic matrix P .

6. (a) If $A^n \mathbf{x} \approx \lambda_1^n a_1 \mathbf{u}_1$ then $(A^n \mathbf{x})_i / (1 \ 1 \ 1) A^n \mathbf{x} \approx (\lambda_1^n a_{1i}) / (\lambda_1^n a_1 (1 \ 1 \ 1) \mathbf{u}_1) = u_{i1} / \text{sum}(\mathbf{u}_1)$.
 (b) Each row in $A^n \mathbf{x}$ is just the sum of the entries in row i of A^n , i.e. $\sum_j (A^n)_{ij}$ is the sum over j of the number of paths of length n connecting i to j , or the total number of paths of length n connecting i to any other vertex. Thus $(A^n \mathbf{x})_i / \text{sum}(A^n \mathbf{x})$ represents the proportion of all paths of length n which start from i ; the greater this proportion, the more paths of length n come from vertex i . As $n \rightarrow \infty$ this gives the proportion of all paths (of any length) which start from i .
 (c) (i) From solutions to MATLAB 6.1, 11(a)

```
>> A=zeros(4,4); % Now put in 1's in row i in the "columns" connected to i.
>> A(1,[2 3 4])=[1 1 1];A(2,[1 3 4])=[1 1 1];
>> A(3,[1 2 4])=[1 1 1];A(4,[2 3 4])=[1 1 1];
>> [V,D]=eig(A); % Compute eigenvectors and values
>> diag(D)' % Look at eigenvalues
ans =
-1.0000 0 3.0000 -1.0000
>> V(:,3)/sum(V(:,3)) % Importance vector as D(3,3) largest eigenvalue.
ans =
0.2500
0.2500
0.2500
0.2500
```

Each vertex has equal importance. This is to be expected since the graph is totally symmetric, with each vertex connected to every other vertex.

(ii) From MATLAB 6.1, 11(b)

```
>> A=zeros(6,6); % Put in 1's in row i in the "columns" connected to i.
>> A(1,[2 5 6])=[1 1 1];A(2,[1 3 6])=[1 1 1];
>> A(3,[2 4 6])=[1 1 1];A(4,[3 5 6])=[1 1 1];
>> A(5,[1 4 6])=[1 1 1];A(6,1:5)=[1 1 1 1 1];
>> [V,D]=eig(A); % Compute eigenvectors and values
>> diag(D)' % Look at eigenvalues
ans =
-1.6180    0.6180   -1.6180    0.6180    3.4495   -1.4495
>> V(:,5)/sum(V(:,5)) % Importance vector as D(5,5) largest eigenvalue.
ans =
0.1551
0.1551
0.1551
0.1551
0.1551
0.2247
```

Vertex 6 is the most important, and all others are of equal but lesser importance. The symmetry of vertices 1 to 5, each connected to the same number of vertices suggests they should have equal importance, while the greater number of connections from vertex 6 suggests it should be more important.

(iii) From MATLAB 6.1, 11(c)

```
>> A=zeros(5,5); % Now put in 1's in row i in the "columns" connected to i.
>> A(1,[2 4 5])=[1 1 1];A(2,[1 3 4 5])=[1 1 1 1];
>> A(3,[2 4 5])=[1 1 1];A(4,[1 2 3 5])=[1 1 1 1];
>> A(5,[1 2 3 4])=[1 1 1 1];
>> [V,D]=eig(A); diag(D)' % Examine eigenvalues to find the largest
ans =
-1.0000    0.0000   -1.0000   -1.6458    3.6458
>> V(:,5)/sum(V(:,5)) % Importance vector as D(5,5) largest eigenvalue.
ans =
0.1771
0.2153
0.1771
0.2153
0.2153
```

Again the symmetry of the connection patterns for vertices 2, 4, 5 and for 1, 3 suggests members of each of these two groups should have equal importance, while the greater number of adjacent vertices for the 2,4,5 group suggests members of this group are more important than those in the 1,3 group.

(iv) For the airline route graph the adjacency matrix is:

```
>> A=zeros(8,8);
>> A(1,4)=1; A(2,[4 6])=[1 1] ; A(3, [4 7 8]) = [1 1 1];
>> A(4,[1 2 3 7]) = [1 1 1 1] ; A(5, [2 7 8]) = [1 1 1];
>> A(6,[2 8])=[1 1]; A(7, [3 4 5]) = [1 1 1]; A(8,[3 5 6]) = [1 1 1];
>> [V,D]=eig(A); diag(D)' % Look for largest eigenvalue
ans =
  Columns 1 through 7
  -2.2909    2.8343   -1.8650         0    1.2524    0.1610    0.8601
  Column 8
  -0.9520
>> V(:,2)/sum(V(:,2)) % Importance as D(2,2) largest.
ans =
  0.0598
  0.0874
  0.1662
  0.1694
  0.1372
  0.0784
  0.1668
  0.1347
```

City number 4 has, proportionally, more multistop routes issuing from it than any other city with 7 and then 3 slightly behind. The fact that city 4 connects directly to more cities (4) than any other city is immediately obvious from the graph, but the more subtle fact that there are proportionally more paths of any (large) length n starting from city 4 requires a more complex analysis; one based on the eigenvalue/eigenvector properties of A and its powers.

Section 6.3

In each of 1–15 the solutions only give λ_i and \mathbf{v}_i and $C = (\mathbf{v}_1, \dots, \mathbf{v}_n)$. You should also compute

AC , $C \begin{pmatrix} \lambda_1 & & 0 \\ & \ddots & \\ 0 & & \lambda_n \end{pmatrix}$, and verify they are equal.

- By problem 1, section 6.1, the eigenvalues of A are 3, -4 . Since the eigenvalues of A are distinct, A is diagonalizable. Eigenvector for $\lambda = -4$: $\begin{pmatrix} 1 \\ 1 \end{pmatrix}$; Eigenvector for $\lambda = 3$: $\begin{pmatrix} -2 \\ 5 \end{pmatrix}$. Then $C = \begin{pmatrix} 1 & -2 \\ 1 & 5 \end{pmatrix}$.
- $\begin{vmatrix} 3 - \lambda & -1 \\ -2 & 4 - \lambda \end{vmatrix} = \lambda^2 - 7\lambda + 10$; Eigenvalues: 2, 5. Since the eigenvalues of A are distinct, A is diagonalizable. Eigenvector for $\lambda = 2$: $\begin{pmatrix} 1 \\ 1 \end{pmatrix}$; Eigenvector for $\lambda = 5$: $\begin{pmatrix} -1 \\ 2 \end{pmatrix}$. Then $C = \begin{pmatrix} 1 & -1 \\ 1 & 2 \end{pmatrix}$.
- By problem 3, section 6.1, the eigenvalues of A are i , $-i$. Since the eigenvalues of A are distinct, A is diagonalizable. Eigenvector for $\lambda = i$: $\begin{pmatrix} 1 \\ 2 - i \end{pmatrix}$; taking conjugates, eigenvector for $\lambda = -i$: $\begin{pmatrix} 1 \\ 2 + i \end{pmatrix}$. Then $C = \begin{pmatrix} 1 & 1 \\ 2 - i & 2 + i \end{pmatrix}$.
- $\begin{vmatrix} 3 - \lambda & -5 \\ 1 & -1 - \lambda \end{vmatrix} = \lambda^2 - 2\lambda + 2$; Eigenvalues: $1 + i$, $1 - i$. Since the eigenvalues of A are distinct, A is diagonalizable. Eigenvector for $\lambda = 1 + i$: $\begin{pmatrix} 5 \\ 2 - i \end{pmatrix}$; taking conjugates, eigenvector for $\lambda = 1 - i$: $\begin{pmatrix} 5 \\ 2 + i \end{pmatrix}$. Then $C = \begin{pmatrix} 5 & 5 \\ 2 - i & 2 + i \end{pmatrix}$.
- By problem 6, section 6.1, the eigenvalues of A are $2 + 3i$, $2 - 3i$. Since the eigenvalues of A are distinct, A is diagonalizable. Eigenvector for $\lambda = 2 + 3i$: $\begin{pmatrix} 2 \\ -1 + 3i \end{pmatrix}$; taking conjugates, eigenvector for $\lambda = 2 - 3i$: $\begin{pmatrix} 2 \\ -1 - 3i \end{pmatrix}$. Then $C = \begin{pmatrix} 2 & 2 \\ -1 + 3i & -1 - 3i \end{pmatrix}$.
- By problem 7, section 6.1, the eigenvalues of A are 0, 1, 3. Since the eigenvalues of A are distinct, A is diagonalizable. Eigenvector for $\lambda = 0$: $\begin{pmatrix} 1 \\ 1 \\ 1 \end{pmatrix}$; Eigenvector for $\lambda = 1$: $\begin{pmatrix} -1 \\ 0 \\ 1 \end{pmatrix}$; Eigenvector for $\lambda = 3$: $\begin{pmatrix} 1 \\ -2 \\ 1 \end{pmatrix}$. Then $C = \begin{pmatrix} 1 & -1 & 1 \\ 1 & 0 & -2 \\ 1 & 1 & 1 \end{pmatrix}$.
- By problem 8, section 6.1, the eigenvalues of A are $-1, 1, 2$. Since the eigenvalues of A are distinct, A is diagonalizable. Eigenvector for $\lambda = 1$: $\begin{pmatrix} 3 \\ 2 \\ 1 \end{pmatrix}$; Eigenvector for $\lambda = 2$: $\begin{pmatrix} 1 \\ 3 \\ 1 \end{pmatrix}$. Eigenvector for $\lambda = -1$: $\begin{pmatrix} 1 \\ 0 \\ 1 \end{pmatrix}$; Then $C = \begin{pmatrix} 3 & 1 & 1 \\ 2 & 3 & 0 \\ 1 & 1 & 1 \end{pmatrix}$.

8. The eigenvalues of A are $2, 0, 0$. $E_2 = \text{span} \left\{ \begin{pmatrix} 1 \\ 0 \\ 0 \end{pmatrix} \right\}$; $E_0 = \text{span} \left\{ \begin{pmatrix} -1 \\ 2 \\ 0 \end{pmatrix}, \begin{pmatrix} -1 \\ 2 \\ 1 \end{pmatrix} \right\}$. Then A is

diagonalizable and $C = \begin{pmatrix} 1 & -1 & -1 \\ 0 & 2 & 2 \\ 0 & 0 & 1 \end{pmatrix}$.

9. The eigenvalues of A are $3, 0, 2$. Since the eigenvalues of A are distinct, A is diagonalizable. Eigenvector for $\lambda = 0$: $\begin{pmatrix} 0 \\ 1 \\ 0 \end{pmatrix}$; Eigenvector for $\lambda = 2$: $\begin{pmatrix} 0 \\ 1 \\ 2 \end{pmatrix}$. Eigenvector for $\lambda = 3$: $\begin{pmatrix} 1 \\ 0 \\ 0 \end{pmatrix}$. Then $C =$

$$\begin{pmatrix} 0 & 0 & 1 \\ 1 & 1 & 0 \\ 0 & 2 & 0 \end{pmatrix}.$$

10. $\begin{vmatrix} 3-\lambda & -1 & -1 \\ 1 & 1-\lambda & -1 \\ 1 & -1 & 1-\lambda \end{vmatrix} = 4 - 8\lambda + 5\lambda^2 - \lambda^3$; Eigenvalues: $1, 2, 2$. $E_2 = \text{span} \left\{ \begin{pmatrix} 1 \\ 1 \\ 0 \end{pmatrix}, \begin{pmatrix} 1 \\ 0 \\ 1 \end{pmatrix} \right\}$; $E_1 = \text{span} \left\{ \begin{pmatrix} 1 \\ 1 \\ 1 \end{pmatrix} \right\}$. Then A is diagonalizable and $C = \begin{pmatrix} 1 & 1 & 1 \\ 1 & 0 & 1 \\ 0 & 1 & 1 \end{pmatrix}$.

11. By problem 14, section 6.1, the eigenvalues of A are $1, 1, 2$. $E_1 = \text{span} \left\{ \begin{pmatrix} 1 \\ 3 \\ 0 \end{pmatrix}, \begin{pmatrix} 0 \\ -2 \\ 1 \end{pmatrix} \right\}$; $E_2 = \text{span} \left\{ \begin{pmatrix} 2 \\ 1 \\ 2 \end{pmatrix} \right\}$. Then A is diagonalizable and $C = \begin{pmatrix} 1 & 0 & 2 \\ 3 & -2 & 1 \\ 0 & 1 & 2 \end{pmatrix}$.

12. By problem 15, section 6.1, A is not diagonalizable since the eigenvalue of 2 has algebraic multiplicity two and geometric multiplicity one.

13. $\begin{vmatrix} -3-\lambda & -7 & -5 \\ 2 & 4-\lambda & 3 \\ 1 & 2 & 2-\lambda \end{vmatrix} = 1 - 3\lambda + 3\lambda^2 - \lambda^3$; Eigenvalues: $1, 1, 1$. $E_3 = \text{span} \left\{ \begin{pmatrix} -3 \\ 1 \\ 1 \end{pmatrix} \right\}$. A is not diagonalizable since the algebraic multiplicity of 1 is three and the geometric multiplicity of 1 is one.

14. $\begin{vmatrix} -2-\lambda & -2 & 0 & 0 \\ -5 & 1-\lambda & 0 & 0 \\ 0 & 0 & 2-\lambda & -1 \\ 0 & 0 & 5 & -2-\lambda \end{vmatrix} = \lambda^4 + \lambda^3 - 11\lambda^2 + \lambda - 12$; Eigenvalues: $3, -4, i, -i$. Since the eigen-

values are distinct, A is diagonalizable. Eigenvector for $\lambda = 3$: $\begin{pmatrix} -2 \\ 5 \\ 1 \\ 1 \end{pmatrix}$; Eigenvector for $\lambda = -4$:

$\begin{pmatrix} 1 \\ 1 \\ 0 \\ 0 \end{pmatrix}$; Eigenvector for $\lambda = i$: $\begin{pmatrix} 0 \\ 0 \\ 2+i \\ 5 \end{pmatrix}$; Eigenvector for the conjugate $\lambda = -i$: $\begin{pmatrix} 0 \\ 0 \\ 2-i \\ 5 \end{pmatrix}$. Then

$$C = \begin{pmatrix} -2 & 1 & 0 & 0 \\ 5 & 1 & 0 & 0 \\ 1 & 0 & 2+i & 2-i \\ 1 & 0 & 5 & 5 \end{pmatrix}.$$

15. By problem 15, section 6.1, the eigenvalues of A are 2, 2, 4, 6. $E_2 = \text{span} \left\{ \begin{pmatrix} 0 \\ 0 \\ 1 \\ 0 \end{pmatrix}, \begin{pmatrix} -1 \\ 1 \\ 0 \\ 1 \end{pmatrix} \right\}$; $E_4 =$

$$\text{span} \left\{ \begin{pmatrix} 1 \\ 1 \\ 1 \\ -1 \end{pmatrix} \right\}; E_6 = \text{span} \left\{ \begin{pmatrix} 1 \\ 1 \\ -1 \\ 1 \end{pmatrix} \right\}. \text{ Then } C = \begin{pmatrix} 0 & -1 & 1 & 1 \\ 0 & 1 & 1 & 1 \\ 1 & 0 & 1 & -1 \\ 0 & 1 & -1 & 1 \end{pmatrix}.$$

16. Since A is similar to B , $B = D^{-1}AD$ for some invertible matrix D . Since B is similar to C , $C = E^{-1}BE$ for some invertible matrix E . Then $C = E^{-1}D^{-1}ADE = (DE)^{-1}A(DE)$. Thus A is similar to C .

17. Since A is similar to B , $B = C^{-1}AC$ for some invertible matrix C . Then $B^n = (C^{-1}AC)^n = (C^{-1}AC)(C^{-1}AC)\dots(AC)(C^{-1}AC) = C^{-1}A^nC$, as all interior $CC^{-1} = I$. Thus A^n is similar to B^n for any positive integer n .

18. Suppose C is invertible. If $\mathbf{x} \in N_A$ then $C\mathbf{A}\mathbf{x} = C\mathbf{0} = \mathbf{0}$. Then $\mathbf{x} \in N_{CA}$. If $\mathbf{x} \in N_{CA}$ then $\mathbf{A}\mathbf{x} = \mathbf{0}$ since $\nu(C) = 0$. Thus $\mathbf{x} \in N_A$ if and only if $\mathbf{x} \in N_{CA}$. Then $\nu(CA) = \nu(A)$. Next, suppose $\mathbf{x} \in R_A$. Then there exists \mathbf{y} such that $\mathbf{A}\mathbf{y} = \mathbf{x}$. Since C is invertible, $R_C = \mathbb{R}^n$. Then there exists \mathbf{z} such that $C\mathbf{z} = \mathbf{y}$. Then $AC\mathbf{z} = \mathbf{x}$. Thus $R_A \subseteq R_{AC}$. Suppose $\mathbf{x} \in R_{AC}$. Then there exists \mathbf{z} such that $AC\mathbf{z} = \mathbf{x}$. Let $\mathbf{y} = C\mathbf{z}$. Then $\mathbf{A}\mathbf{y} = \mathbf{x}$. Thus $R_{AC} \subseteq R_A$. Then $R_A = R_{AC}$ and therefore $\rho(AC) = \rho(A)$. Then $\rho(A) + \nu(A) = \rho(CA) + \nu(CA) \Rightarrow \rho(A) = \rho(CA)$. Then $\rho(A) = \rho(AC) = \rho(CA)$. Since C^{-1} is invertible, $\rho(C^{-1}AC) = \rho((AC)C^{-1}) = \rho(A)$. That is, $\rho(B) = \rho(A)$. And then we also have $\nu(A) = \nu(B)$.

19. $\begin{pmatrix} 1 & 0 \\ 0 & -1 \end{pmatrix}^{20} = \begin{pmatrix} 1^{20} & 0 \\ 0 & (-1)^{20} \end{pmatrix} = \begin{pmatrix} 1 & 0 \\ 0 & 1 \end{pmatrix}.$

20. Since A is similar to B , $B = C^{-1}AC$ for some invertible matrix C . Then $\det B = \det(C^{-1}AC) = \frac{1}{\det C}(\det A)(\det C) = \det A$.

21. Since $C^{-1}AC = D$ then $A = CDC^{-1}$. Then $A^n = (CDC^{-1})^n = CD^nC^{-1}$, by adapting Problem 17.

22. Let $C = \begin{pmatrix} 2 & 1 \\ 1 & 1 \end{pmatrix}$. Then $C^{-1} \begin{pmatrix} 3 & -4 \\ 2 & -3 \end{pmatrix} C = \begin{pmatrix} 1 & 0 \\ 0 & -1 \end{pmatrix}$, so $\begin{pmatrix} 3 & -4 \\ 2 & -3 \end{pmatrix} = \begin{pmatrix} 2 & 1 \\ 1 & 1 \end{pmatrix} \begin{pmatrix} 1 & 0 \\ 0 & -1 \end{pmatrix} \begin{pmatrix} 1 & -1 \\ -1 & 2 \end{pmatrix}$. Then $\begin{pmatrix} 3 & -4 \\ 2 & -3 \end{pmatrix}^{20} = \begin{pmatrix} 2 & 1 \\ 1 & 1 \end{pmatrix} \begin{pmatrix} 1 & 0 \\ 0 & -1 \end{pmatrix}^{20} \begin{pmatrix} 1 & -1 \\ -1 & 2 \end{pmatrix} = \begin{pmatrix} 1 & 0 \\ 0 & 1 \end{pmatrix}.$

23. Suppose that A is diagonalizable. Note that $D = cI$. Since D is similar to A , $A = C^{-1}DC$ for some invertible matrix C . Then $A = C^{-1}(cI)C = cI$. If $A = cI$ then A is already a diagonal matrix and thus is diagonalizable. Therefore, A is diagonalizable if and only if $A = cI$.

24.
$$\begin{aligned} \begin{pmatrix} 3 & 2 & 4 \\ 2 & 0 & 2 \\ 4 & 2 & 3 \end{pmatrix}^{10} &= \frac{-1}{9} \begin{pmatrix} 2 & 1 & 0 \\ 1 & -2 & -2 \\ 2 & 0 & 1 \end{pmatrix} \begin{pmatrix} 8 & 0 & 0 \\ 0 & -1 & 0 \\ 0 & 0 & -1 \end{pmatrix}^{10} \begin{pmatrix} -2 & -1 & -2 \\ -5 & 2 & 4 \\ 4 & 2 & -5 \end{pmatrix} \\ &= \frac{-1}{9} \begin{pmatrix} 2 & 1 & 0 \\ 1 & -2 & -2 \\ 2 & 0 & 1 \end{pmatrix} \begin{pmatrix} 8^{10} & 0 & 0 \\ 0 & 1 & 0 \\ 0 & 0 & 1 \end{pmatrix} \begin{pmatrix} -2 & -1 & -2 \\ -5 & 2 & 4 \\ 4 & 2 & -5 \end{pmatrix} \\ &= \frac{-1}{9} \begin{pmatrix} 2 & 1 & 0 \\ 1 & -2 & -2 \\ 2 & 0 & 1 \end{pmatrix} \begin{pmatrix} -2 \times 8^{10} & -8^{10} & -2 \times 8^{10} \\ & -5 & 2 & 4 \\ & 4 & 2 & -5 \end{pmatrix} \end{aligned}$$

$$= \frac{-1}{9} \begin{pmatrix} -4 \times 8^{10} - 5 & -2 \times 8^{10} + 2 & -4 \times 8^{10} + 4 \\ -2 \times 8^{10} + 2 & -8^{10} - 8 & -2 \times 8^{10} + 2 \\ -4 \times 8^{10} + 4 & -2 \times 8^{10} + 2 & -4 \times 8^{10} - 5 \end{pmatrix}$$

25. Both A and B have n linearly independent eigenvectors since they both have distinct eigenvalues. Then $D_1 = C_1^{-1}AC_1$ and $D_2 = C_2^{-1}BC_2$. Suppose A and B have the same eigenvectors. Then $C_1 = C_2 = C$ and $AB = (CD_1C^{-1})(CD_2C^{-1}) = CD_1D_2C^{-1} = CD_2D_1C^{-1} = (CD_2C^{-1})(CD_1C^{-1}) = BA$. Suppose $AB = BA$. Let \mathbf{x} be an eigenvector of B with corresponding eigenvalue λ . Then $BA\mathbf{x} = AB\mathbf{x} = A(\lambda\mathbf{x}) = \lambda A\mathbf{x}$. Then $A\mathbf{x}$ is an eigenvector for B corresponding to λ . Since the algebraic multiplicity of $\lambda = 1$, $A\mathbf{x} = \mu\mathbf{x}$ for some $\mu \in \mathbb{R}$. Thus \mathbf{x} is also an eigenvector of A . Similarly, every eigenvector of A is also an eigenvector of B .
26. Since A is diagonalizable, A is similar to the diagonal matrix $D = \text{diag}(\lambda_1, \lambda_2, \dots, \lambda_n)$. Then $\det A = \det D = \lambda_1\lambda_2 \cdots \lambda_n$.

CALCULATOR SOLUTIONS 6.3

Problems 27-30 ask for a matrix C such that $C^{-1}AC$ is a diagonal matrix, when A is the matrix given in the problem. These problems are easy to solve, since the required matrix is just the matrix of eigenvectors for the given matrix A . If we look carefully, we note that the matrices for these problems are the matrices from Problems 37-40 in Section 6.1. In our solutions to those problems we computed the required eigenvector matrices, and saved them in variables VC61nn. So for Problem mm in this section, $C = VC61(m+1)m$. The instructions in the text show you how to actually verify the requisite product is diagonal if you wish to. With the notation we have used in our solutions you would enter (say for problem 28) VC6138 $\boxed{x^{-1}}$ $\boxed{\times}$ A6138 $\boxed{\times}$ VC6138 $\boxed{\text{ENTER}}$. We expect that the result will have as its diagonal entries the elements of VL6138 in order and that any off diagonal non-zero entries will be small relative to the diagonal entries. (We expect about 12 orders of magnitude decrease in the size of any non-diagonal entries.)

27. VC6137 (or EIGVC A6137) $\boxed{\text{STO}\blacktriangleright}$ C6327 $\boxed{\text{ENTER}}$ yields the matrix

```
[[ (-.62142715,0) (.71687784,0) (.04543794,-3.19251194) (.04543794, 3.19251194) ]
 [ (-.31716213,0) (-.10298644,0) (-.48915686,-1.06860326) (-.48915686, 1.06860326) ]
 [ (-.60074151,0) (.46085995,0) (.56855460,-1.47374850) (.56855460, 1.47374850) ]
 [ (-.64889372,0) (-.47071528,0) (.18909574, 3.31095939) (.18909574,-3.31095939) ]]
```

28. VC6138 $\boxed{\text{STO}\blacktriangleright}$ C6328 $\boxed{\text{ENTER}}$ yields the matrix $\begin{bmatrix} .80930625 & -.41169877 & .17282897 \\ .39760427 & .79901338 & .43021880 \\ .57142906 & .83487921 & -.72384690 \end{bmatrix}$.

29. EIGVC A6139 $\boxed{\text{STO}\blacktriangleright}$ C6129 $\boxed{\text{ENTER}}$ yields the matrix

```
[[ -.86904182 -1.13177594 .03887837 ]
 [ -.05274303 -.76511960 1.21858619 ]
 [ .40418751 .13423638 -.98551797 ]]
```

30. VC6140 $\boxed{\text{STO}\blacktriangleright}$ C6330 $\boxed{\text{ENTER}}$ yields the matrix

```
[[ (.30391413,0) (-.41583517,0) (.07216788, .02724822) (.07216788, -.02724822) (-.18257769,0) ]
 [ (.43510240,0) (.35954684,0) (.49417683,-.12406035) (.49417683, .12406035) (.65346843,0) ]
 [ (.85461548,0) (-.63331201,0) (-.11345962,1.60773524) (-.11345962,-1.60773524) (-2.15604925,0) ]
 [ (.77355755,0) (.29739916,0) (-.06111309,-.74473569) (-.06111309, .74473569) (1.65335384,0) ]
 [ (.85494504,0) (.31477757,0) (-.36238989,-.37130114) (-.36238989, .37130114) (-.39568255,0) ]]
```

MATLAB 6.3

1. See MATLAB 6.1, solution for problem 8, which shows CAC^{-1} and A have the same eigenvalues.
- 2.

```
>> A=10*rand(4)-5*ones(4,4);
>> [V,D]=eig(A)
V =
-0.4178 - 0.5436i -0.4178 + 0.5436i -0.4771 + 0.4123i -0.4771 - 0.4123i
 0.2137 - 0.5274i  0.2137 + 0.5274i -0.1702 - 0.1398i -0.1702 + 0.1398i
-0.2502 - 0.0064i -0.2502 + 0.0064i  0.5903 - 0.3344i  0.5903 + 0.3344i
-0.3449 + 0.1564i -0.3449 - 0.1564i -0.3048 + 0.0266i -0.3048 - 0.0266i
D =
-2.6731 + 7.0801i      0      0      0
      0      -2.6731 - 7.0801i      0      0
      0      0      0.4213 + 1.0786i      0
      0      0      0      0.4213 - 1.0786i
>> A-V*D*inv(V)
ans =
 1.0e-14 *
-0.2220 - 0.1166i -0.3553 + 0.2220i -0.4441 - 0.0305i  0.2665 + 0.2331i
-0.2665 - 0.0708i  0.3997 + 0.0638i -0.5329 - 0.0375i  0.0888 + 0.1069i
-0.0666 - 0.0555i -0.1776 + 0.0611i -0.0555 - 0.0500i  0.3553 + 0.1055i
 0.1110 - 0.0014i -0.2665 + 0.0333i  0.1554 + 0.0222i  0.2331 + 0.0167i
```

- (a) Almost all random matrices have distinct eigenvalues, i.e. all eigenvalues have algebraic multiplicity one, just like almost all random matrices are invertible.
 - (b) When A has distinct eigenvalues, then there exists a basis of eigenvectors by 6.1, Theorem 6. This says the matrix V of eigenvectors will be invertible and by the Corollary to Theorem 2, $VDV^{-1} = A$, since $AV = VD$ just expresses the eigenvector properties of the columns of V .
3. (a)

```
>> A=[38 -95 55; 35 -92 55; 35 -95 58]; % Matrix from MATLAB 6.1, problem 1
>> x= [1 1 1]'; lambda = -2 ; % x is an eigenvector for the eigenvalue lambda
>> y= [3 4 5]'; mu = 3 ; % y is an eigenvector for the eigenvalue mu
>> z= [4 9 13]'; mu = 3 ; % z is an eigenvector for the eigenvalue mu
>> rref([x y z]) % Since this is I, {x,y,z} is a basis.
ans =
 1      0      0
 0      1      0
 0      0      1
>> C=[x y z] % An invertible matrix with independent eigenvectors as columns
C =
 1      3      4
 1      4      9
 1      5     13
```

```

>> D=diag([lambda mu mu]) % Diagonal entries are eigenvalues for columns of C
D =
    -2     0     0
     0     3     0
     0     0     3
>> C*D*inv(C) % This is A
ans =
    38   -95    55
    35   -92    55
    35   -95    58

```

(b)

```

>> A = [ 1 1 .5 -1 ; -2 1 -1 0; 0 2 0 2; 2 1 -1.5 2]
A =
    1.0000    1.0000    0.5000   -1.0000
   -2.0000    1.0000   -1.0000     0
     0     2.0000     0     2.0000
    2.0000    1.0000   -1.5000    2.0000
>> x = [ 1 i 0 -i].'; lambda = 1+2*i ;
>> v = [ 0 i 2 1+i].';
>> y = [ 1 -i 0 i].'; mu = 1-2*i ;
>> z = [ 0 -i 2 1-i].';

>> rref([x v y z]) % Since this is I, {x,v,y,z} is a basis.
ans =
     1     0     0     0
     0     1     0     0
     0     0     1     0
     0     0     0     1

>> C=[x v y z] % An invertible matrix with independent eigenvectors as columns
C =
    1.0000         0    1.0000         0
     0 + 1.0000i     0 + 1.0000i     0 - 1.0000i     0 - 1.0000i
     0         2.0000         0         2.0000
     0 - 1.0000i    1.0000 + 1.0000i     0 + 1.0000i    1.0000 - 1.0000i

>> D=diag([lambda lambda mu mu]) % Diagonals are eigenvalues for columns of C
D =
    1.0000 + 2.0000i     0         0         0
     0         1.0000 + 2.0000i     0         0
     0         0         1.0000 - 2.0000i     0
     0         0         0         1.0000 - 2.0000i

>> A-C*D*inv(C) % Zero so A=C*D*inv(C) (it might just have been close to 0).
ans =
     0     0     0     0
     0     0     0     0
     0     0     0     0
     0     0     0     0

```

4. (a)

```

>> A = [ 1 -1 0; -1 2 -1; 0 -1 1];
>> d=eig(A), dd=d.^20; % Take the 20'th power of the eigenvalues of A.
d =
    0.0000
    1.0000
    3.0000
>> E=diag(dd)
E =
  1.0e+09 *
    0.0000         0         0
         0    0.0000         0
         0         0    3.4868
>> [V,D]=eig(A); % Find the eigenvectors for A.
>> E-D^20 % Zero up to round-off.
ans =
  1.0e-05 *
         0         0
         0         0
         0         0    0.4292

```

This should be zero since any power of a diagonal matrix is formed by just taking that power of the diagonal elements. (The failure of exact equality is only a relative error of about $1E-14$ and shows that the MATLAB algorithm for computing matrix powers (of a diagonal) does not just take powers (of the diagonal elements).)

```

>> A^20-V*E*inv(V) % Will be zero
ans = % (up to relative round-off error of about 1e-14).
  1.0e-04 *
 -0.0262    0.0525   -0.0250
  0.0525   -0.1049    0.0501
 -0.0262    0.0525   -0.0250

```

(b)

```

>> A=[3 9.5 -2 -10.5; -10 -42.5 10 44.5; 6 23.5 -5 -24.5; -10 -43 10 45];
>> d=eig(A), dd=d.^20; % Take the 20'th power of the eigenvalues of A.
d =
 -3.0000
  2.0000
  1.0000
  0.5000
>> E=diag(dd)
E =
  1.0e+09 *
  3.4868         0         0         0
         0    0.0010         0         0
         0         0    0.0000         0
         0         0         0    0.0000

```

```

>> [V,D]=eig(A);           % Find the eigenvectors for A.
>> E=D^20                  % Zero up to round-off, so E=D^20.
ans =
  1.0e-05 *
    0.4768         0         0         0
         0         0         0         0
         0         0         0         0
         0         0         0         0

>> A^20-V*E*inv(V)        % Zero up to round-off, so A^20=V*E*inv(V).
ans =
    0.0000   -0.0001    0.0000    0.0001
   -0.0014   -0.0056    0.0014    0.0056
    0.0007    0.0028   -0.0007   -0.0028
   -0.0014   -0.0056    0.0014    0.0056

```

- (c) From $C^{-1}DC = A$ we get $A = CDC^{-1}$. Then $A^n = (C^{-1}DC)(C^{-1}DC)\dots(C^{-1}DC)(C^{-1}DC)$, n factors of CDC^{-1} . The interior adjoining CC^{-1} all give I , leaving n factors of D , i.e. $A^n = CD^nC^{-1}$. (Compare with 6.3, problem 17 or 21.)
5. (a) $Ax = \lambda x$ for $\lambda > 0$ says that A expands or compresses x , depending on whether $\lambda \geq 1$ or $\lambda \leq 1$.
- (b) A expands or compresses each eigenvector by a factor given by the associated eigenvalue. If A is diagonalizable there is a basis of eigenvectors. Since any vector is a linear combination of the eigenvectors in this basis, the effect of multiplication by A on any vector can be described as a linear combination of the expansions or compressions along the directions of the basis vectors.
- (c)

```

>> A=[5/2 1/2;1/2 5/2];
>> [V,D]=eig(A) % Since D has distinct entries, A is diagonalizable
V =
    0.7071    0.7071
   -0.7071    0.7071
D =
     2     0
     0     3

>> V*diag([1 1]./min(V)) % This divides each eigenvector in V by its' minimum
ans =
    -1     1
     1     1

```

The last result shows the eigenvectors are in the directions $(1, -1)^t$ and $(1, 1)^t$ and the eigenvalues in D show multiplication by A expands in the direction $(1, -1)^t$ by a factor of 2 and expands the direction $(1, 1)^t$ by a factor of 3. To sketch the image of the rectangle, whose corners are at eigenvectors, take the diagonal running from the $(-1, -1)$ corner to the $(1, 1)$ corner and stretch by a factor of 3 in each direction; take the other diagonal and stretch by a factor of 2 in each direction. Your sketch should yield a rhombus.

(d) (i)

```
>> A=[15 -31 17; 20.5 -44 24.5; 26.5 -58 32.5];
>> [V,D]=eig(A) % Distinct diagonal entries in D>0 so A is diagonalizable
V =
-0.4243 -0.2453 0.5774
-0.5657 -0.5518 0.5774
-0.7071 -0.7971 0.5774
D =
2.0000 0 0
0 0.5000 0
0 0 1.0000

>> inv(V)*A*V % This verifies A is diagonalizable
ans =
2.0000 0.0000 0.0000
0.0000 0.5000 0.0000
0.0000 0.0000 1.0000

>> V*diag([1 1 1]./min(abs(V))) % Give eigenvectors with nice entries
ans =
-1.0000 -1.0000 1.0000
-1.3333 -2.2500 1.0000
-1.6667 -3.2500 1.0000

>> ans*diag([3 4 1]) % Still nicer eigenvectors
ans =
-3.0000 -4.0000 1.0000
-4.0000 -9.0000 1.0000
-5.0000 -13.0000 1.0000
```

The last matrix computed has three independent eigenvectors for columns, and shows that the geometry of A is given by an expansion by a factor of 2 in the direction $(3\ 4\ 5)^t$, compression by a factor of $1/2$ in the direction of $(4\ 9\ 13)$ and expansion by a factor of 1 in the direction $(1\ 1\ 1)^t$.

(ii)

```
>> B=10*rand(3)-5*ones(3,3); A=B'*B
A =
31.6145 -26.8123 -23.8618
-26.8123 23.4677 20.1571
-23.8618 20.1571 32.6538

>> [V,D]=eig(A) % D has 3 distinct positive entries,
V = % so A is diagonalizable
0.6599 0.4240 -0.6203
0.7511 -0.3930 0.5305
0.0188 0.8160 0.5778
D =
0.4161 0 0
0 10.5457 0
0 0 76.7743
```

The three independent eigenvector columns of V give directions of expansion/compression for multiplication by A .

6. (a)

```

>> A=[22 -10; 50 -23]; e = eig(A) , d = det(A)
e =
     2
    -3
d =
    -6

>> A=[8 3; .5 5.5]; e = eig(A) , d = det(A)
e =
    8.5000
    5.0000
d =
   42.5000

>> A=[5 -11 7; -2 1 2; -6 7 0]; e = eig(A) , d = det(A)
e =
    2.0000
    1.0000
    3.0000
d =
     6

>> A=[26 -68 40;19 -56 35;15 -50 33]; e = eig(A) , d = det(A)
e =
   -2.0000
    2.0000
    3.0000
d =
   -12

```

For each A the eigenvalues in e are distinct, so a set consisting of one eigenvector for each eigenvalue will be a basis, the matrix C with this basis as columns will be invertible and $C^{-1}AC$ will be diagonal with the eigenvalues on the diagonal; this says A is diagonalizable.

For each A the product of the eigenvalues is equal to $\det(A)$.

(b)

```

>> A = [ 38 -95 55; 35 -92 55; 35 -95 58]; % Matrix from MATLAB 6.1, 1
>> det(A), (-2)*3*3 % This verifies det(A) = the product of the eigenvalues
ans =
   -18
ans =
   -18
>> A = [ 1 1 .5 -1 ; -2 1 -1 0; 0 2 0 2; 2 1 -1.5 2]
A =
    1.0000    1.0000    0.5000   -1.0000
   -2.0000    1.0000   -1.0000     0
     0     2.0000     0     2.0000
    2.0000    1.0000   -1.5000    2.0000

>> det(A), (1+2*i)^2*(1-2*i)^2 % This verifies det(A) = product of eigenvalues
ans =
    25
ans =
   25.0000

```

- (c) If A is diagonalizable, then $\det(A)$ is the product of the eigenvalues for A (counting algebraic multiplicity). Proof: Since $A = C^{-1}DC$ where D has the eigenvalues for A along its diagonal, $\det(A) = (1/\det(C))\det(D)\det(C) = \det(D) = d_{11}d_{22}\dots d_{nn}$. The equalities come from the product rule for determinants, the fact that $\det(C^{-1}) = 1/\det(C)$ and the fact that the determinant of a diagonal matrix is the product of its diagonal entries.

Section 6.4

1. The eigenvalues of A are $\lambda_1 = 5$ and $\lambda_2 = -5$. The corresponding eigenvectors are $\mathbf{v}_1 = \begin{pmatrix} 2 \\ 1 \end{pmatrix}$ and

$$\mathbf{v}_2 = \begin{pmatrix} 1 \\ -2 \end{pmatrix}.$$

$$|\mathbf{v}_1| = |\mathbf{v}_2| = \sqrt{5}. \text{ Thus } Q = \frac{1}{\sqrt{5}} \begin{pmatrix} 2 & 1 \\ 1 & -2 \end{pmatrix}, Q^t = \frac{1}{\sqrt{5}} \begin{pmatrix} 2 & 1 \\ 1 & -2 \end{pmatrix} \text{ and}$$

$$\begin{aligned} Q^t A Q &= \frac{1}{5} \begin{pmatrix} 2 & 1 \\ 1 & -2 \end{pmatrix} \begin{pmatrix} 3 & 4 \\ 4 & -3 \end{pmatrix} \begin{pmatrix} 2 & 1 \\ 1 & -2 \end{pmatrix} = \frac{1}{5} \begin{pmatrix} 2 & 1 \\ 1 & -2 \end{pmatrix} \begin{pmatrix} 10 & -5 \\ 5 & 10 \end{pmatrix} \\ &= \frac{1}{5} \begin{pmatrix} 25 & 0 \\ 0 & -25 \end{pmatrix} = \begin{pmatrix} 5 & 0 \\ 0 & -5 \end{pmatrix}. \end{aligned}$$

2. The eigenvalues of A are $\lambda_1 = 1$ and $\lambda_2 = 3$. The corresponding eigenvectors are $\mathbf{v}_1 = \begin{pmatrix} 1 \\ -1 \end{pmatrix}$ and

$$\mathbf{v}_2 = \begin{pmatrix} 1 \\ 1 \end{pmatrix}.$$

$$|\mathbf{v}_1| = |\mathbf{v}_2| = \sqrt{2}. \text{ Thus } Q = \frac{1}{\sqrt{2}} \begin{pmatrix} 1 & 1 \\ -1 & 1 \end{pmatrix}, Q^t = \frac{1}{\sqrt{2}} \begin{pmatrix} 1 & -1 \\ 1 & 1 \end{pmatrix} \text{ and}$$

$$\begin{aligned} Q^t A Q &= \frac{1}{2} \begin{pmatrix} 1 & -1 \\ 1 & 1 \end{pmatrix} \begin{pmatrix} 2 & 1 \\ 1 & 2 \end{pmatrix} \begin{pmatrix} 1 & 1 \\ -1 & 1 \end{pmatrix} = \frac{1}{2} \begin{pmatrix} 1 & -1 \\ 1 & 1 \end{pmatrix} \begin{pmatrix} 1 & 3 \\ -1 & 3 \end{pmatrix} \\ &= \frac{1}{2} \begin{pmatrix} 2 & 0 \\ 0 & 6 \end{pmatrix} = \begin{pmatrix} 1 & 0 \\ 0 & 3 \end{pmatrix}. \end{aligned}$$

3. The eigenvalues of A are $\lambda_1 = 0$ and $\lambda_2 = 2$. The corresponding eigenvectors are $\mathbf{v}_1 = \begin{pmatrix} 1 \\ 1 \end{pmatrix}$ and

$$\mathbf{v}_2 = \begin{pmatrix} 1 \\ -1 \end{pmatrix}. |\mathbf{v}_1| = |\mathbf{v}_2| = \sqrt{2}. \text{ Thus } Q = \frac{1}{\sqrt{2}} \begin{pmatrix} 1 & 1 \\ 1 & -1 \end{pmatrix}, Q^t = \frac{1}{\sqrt{2}} \begin{pmatrix} 1 & 1 \\ 1 & -1 \end{pmatrix} \text{ and}$$

$$Q^t A Q = \frac{1}{2} \begin{pmatrix} 1 & 1 \\ 1 & -1 \end{pmatrix} \begin{pmatrix} 1 & -1 \\ -1 & 1 \end{pmatrix} \begin{pmatrix} 1 & 1 \\ 1 & -1 \end{pmatrix} = \frac{1}{2} \begin{pmatrix} 1 & 1 \\ 1 & -1 \end{pmatrix} \begin{pmatrix} 0 & 2 \\ 0 & -2 \end{pmatrix} = \begin{pmatrix} 0 & 0 \\ 0 & 2 \end{pmatrix}.$$

4. The eigenvalues of A are $\lambda_1 = 2$ and $\lambda_2 = -1$. Independent eigenvectors corresponding to λ_1 are $\mathbf{v}_1 = \begin{pmatrix} 1 \\ -1 \\ 0 \end{pmatrix}$ and $\mathbf{v}_2 = \begin{pmatrix} 0 \\ 1 \\ -1 \end{pmatrix}$. An eigenvector corresponding to λ_2 is $\mathbf{v}_3 = \begin{pmatrix} 1 \\ 1 \\ 1 \end{pmatrix}$. Orthogonalize $\mathbf{v}_1, \mathbf{v}_2$:

$$|\mathbf{v}_1| = \sqrt{2} \text{ so let } \mathbf{u}_1 = \begin{pmatrix} 1/\sqrt{2} \\ -1/\sqrt{2} \\ 0 \end{pmatrix}. \text{ Now } \mathbf{v}'_2 = \mathbf{v}_2 - (\mathbf{v}_2 \cdot \mathbf{u}_1)\mathbf{u}_1 = \begin{pmatrix} 0 \\ 1 \\ -1 \end{pmatrix} + \frac{1}{\sqrt{2}} \begin{pmatrix} 1/\sqrt{2} \\ -1/\sqrt{2} \\ 0 \end{pmatrix} = \begin{pmatrix} 1/2 \\ 1/2 \\ -1 \end{pmatrix}.$$

$$|\mathbf{v}'_2| = \sqrt{6}/2 \text{ so let } \mathbf{u}_2 = \frac{2}{\sqrt{6}} \begin{pmatrix} 1/2 \\ 1/2 \\ -1 \end{pmatrix} = \begin{pmatrix} 1/\sqrt{6} \\ 1/\sqrt{6} \\ -2/\sqrt{6} \end{pmatrix}. \text{ We also have } \mathbf{u}_3 = \mathbf{v}_3/|\mathbf{v}_3| = \frac{1}{\sqrt{3}} \mathbf{v}_3 = \begin{pmatrix} 1/\sqrt{3} \\ 1/\sqrt{3} \\ 1/\sqrt{3} \end{pmatrix}.$$

$$\begin{aligned} \text{Thus } Q &= \begin{pmatrix} 1/\sqrt{2} & 1/\sqrt{6} & 1/\sqrt{3} \\ -1/\sqrt{2} & 1/\sqrt{6} & 1/\sqrt{3} \\ 0 & -2/\sqrt{6} & 1/\sqrt{3} \end{pmatrix} \begin{pmatrix} 1 & -1 & -1 \\ -1 & 1 & -1 \\ -1 & -1 & 1 \end{pmatrix} \begin{pmatrix} 1/\sqrt{2} & 1/\sqrt{6} & 1/\sqrt{3} \\ -1/\sqrt{2} & 1/\sqrt{6} & 1/\sqrt{3} \\ 0 & -2/\sqrt{6} & 1/\sqrt{3} \end{pmatrix} \\ &= \begin{pmatrix} 1/\sqrt{2} & -1/\sqrt{2} & 0 \\ 1/\sqrt{6} & 1/\sqrt{6} & -2/\sqrt{6} \\ 1/\sqrt{3} & 1/\sqrt{3} & 1/\sqrt{3} \end{pmatrix} \begin{pmatrix} 2/\sqrt{2} & 2/\sqrt{6} & -1/\sqrt{3} \\ -2/\sqrt{2} & 2/\sqrt{6} & -1/\sqrt{3} \\ 0 & -4/\sqrt{6} & -1/\sqrt{3} \end{pmatrix} = \begin{pmatrix} 2 & 0 & 0 \\ 0 & 2 & 0 \\ 0 & 0 & -1 \end{pmatrix}. \end{aligned}$$

5. The eigenvalues of A are $\lambda_1 = -3$, $\lambda_2 = 1 + 2\sqrt{2}$, and $\lambda_3 = 1 - 2\sqrt{2}$, with corresponding eigenvectors

$$\mathbf{v}_1 = \begin{pmatrix} -1 \\ 1 \\ 0 \end{pmatrix}, \mathbf{v}_2 = \begin{pmatrix} 1/\sqrt{2} \\ 1/\sqrt{2} \\ 1 \end{pmatrix}, \mathbf{v}_3 = \begin{pmatrix} 1/\sqrt{2} \\ 1/\sqrt{2} \\ -1 \end{pmatrix}.$$

Since $|\mathbf{v}_1| = |\mathbf{v}_2| = |\mathbf{v}_3| = \sqrt{2}$, we have

$$Q = \begin{pmatrix} -1/\sqrt{2} & 1/2 & 1/2 \\ 1/\sqrt{2} & 1/2 & 1/2 \\ 0 & 1/\sqrt{2} & -1/\sqrt{2} \end{pmatrix}, Q^t = \begin{pmatrix} -1/\sqrt{2} & 1/\sqrt{2} & 0 \\ 1/2 & 1/2 & 1/\sqrt{2} \\ 1/2 & 1/2 & -1/\sqrt{2} \end{pmatrix}$$

$$\begin{aligned} \text{and } Q^t A Q &= \begin{pmatrix} -1/\sqrt{2} & 1/\sqrt{2} & 0 \\ 1/2 & 1/2 & 1/\sqrt{2} \\ 1/2 & 1/2 & -1/\sqrt{2} \end{pmatrix} \begin{pmatrix} -1 & 2 & 2 \\ 2 & -1 & 2 \\ 2 & 2 & 1 \end{pmatrix} \begin{pmatrix} -1/\sqrt{2} & 1/2 & 1/2 \\ 1/\sqrt{2} & 1/2 & 1/2 \\ 0 & 1/\sqrt{2} & -1/\sqrt{2} \end{pmatrix} \\ &= \begin{pmatrix} -3 & 0 & 0 \\ 0 & 1 + 2\sqrt{2} & 0 \\ 0 & 0 & 1 - 2\sqrt{2} \end{pmatrix}. \end{aligned}$$

6. The eigenvalues of A are $\lambda_1 = 0$, $\lambda_2 = 1$ and $\lambda_3 = 3$. The corresponding eigenvectors are $\mathbf{v}_1 = \begin{pmatrix} 1 \\ 1 \\ 1 \end{pmatrix}$,

$$\mathbf{v}_2 = \begin{pmatrix} 1 \\ 0 \\ -1 \end{pmatrix} \text{ and } \mathbf{v}_3 = \begin{pmatrix} 1 \\ -2 \\ 1 \end{pmatrix}.$$

Since $|\mathbf{v}_1| = \sqrt{3}$, $|\mathbf{v}_2| = \sqrt{2}$, $|\mathbf{v}_3| = \sqrt{6}$, we have

$$Q = \begin{pmatrix} 1/\sqrt{3} & 1/\sqrt{2} & 1/\sqrt{6} \\ 1/\sqrt{3} & 0 & -2/\sqrt{6} \\ 1/\sqrt{3} & -1/\sqrt{2} & 1/\sqrt{6} \end{pmatrix}, Q^t = \begin{pmatrix} 1/\sqrt{3} & 1/\sqrt{3} & 1/\sqrt{3} \\ 1/\sqrt{2} & 0 & -1/\sqrt{2} \\ 1/\sqrt{6} & -2/\sqrt{6} & 1/\sqrt{6} \end{pmatrix}.$$

$$\begin{aligned} Q^t A Q &= \begin{pmatrix} 1/\sqrt{3} & 1/\sqrt{3} & 1/\sqrt{3} \\ 1/\sqrt{2} & 0 & -1/\sqrt{2} \\ 1/\sqrt{6} & -2/\sqrt{6} & 1/\sqrt{6} \end{pmatrix} \begin{pmatrix} 1 & -1 & 0 \\ -1 & 2 & 1 \\ 0 & -1 & 1 \end{pmatrix} \begin{pmatrix} 1/\sqrt{3} & 1/\sqrt{2} & 1/\sqrt{6} \\ 1/\sqrt{3} & 0 & -2/\sqrt{6} \\ 1/\sqrt{3} & -1/\sqrt{2} & 1/\sqrt{6} \end{pmatrix} \\ &= \begin{pmatrix} 0 & 0 & 0 \\ 0 & 1 & 0 \\ 0 & 0 & 3 \end{pmatrix}. \end{aligned}$$

7. The eigenvalues of A are $\lambda_1 = 0$, $\lambda_2 = 3$ and $\lambda_3 = 6$. The corresponding eigenvectors are $\mathbf{v}_1 =$

$$\begin{pmatrix} -2 \\ 2 \\ 1 \end{pmatrix}, \mathbf{v}_2 = \begin{pmatrix} 1 \\ 2 \\ -2 \end{pmatrix} \text{ and } \mathbf{v}_3 = \begin{pmatrix} 2 \\ 1 \\ 2 \end{pmatrix}.$$

Since $|\mathbf{v}_1| = |\mathbf{v}_2| = |\mathbf{v}_3| = 3$ we have

$$Q = \begin{pmatrix} -2/3 & 1/3 & 2/3 \\ 2/3 & 2/3 & 1/3 \\ 1/3 & -2/3 & 2/3 \end{pmatrix}, Q^t = \begin{pmatrix} -2/3 & 2/3 & 1/3 \\ 1/3 & 2/3 & -2/3 \\ 2/3 & 1/3 & 2/3 \end{pmatrix} \text{ and}$$

$$Q^t A Q = \begin{pmatrix} -2/3 & 2/3 & 1/3 \\ 1/3 & 2/3 & -2/3 \\ 2/3 & 1/3 & 2/3 \end{pmatrix} \begin{pmatrix} 3 & 2 & 2 \\ 2 & 2 & 0 \\ 2 & 0 & 4 \end{pmatrix} \begin{pmatrix} -2/3 & 1/3 & 2/3 \\ 2/3 & 2/3 & 1/3 \\ 1/3 & -2/3 & 2/3 \end{pmatrix} = \begin{pmatrix} 0 & 0 & 0 \\ 0 & 3 & 0 \\ 0 & 0 & 6 \end{pmatrix}.$$

8. The eigenvalues of A are $\lambda_1 = 0$, $\lambda_2 = 2$, $\lambda_3 = (1 + \sqrt{5})/2$, $\lambda_4 = (1 - \sqrt{5})/2$.

the first column. Hence, $Q^*AQ = \begin{pmatrix} \lambda_1 & 0 & 0 & \cdots & 0 \\ 0 & (\bar{\mathbf{u}}_2)^t A \mathbf{u}_2 & (\bar{\mathbf{u}}_2)^t A \mathbf{u}_3 & \cdots & (\bar{\mathbf{u}}_2)^t A \mathbf{u}_n \\ \vdots & \vdots & \vdots & \ddots & \vdots \\ 0 & (\bar{\mathbf{u}}_n)^t A \mathbf{u}_2 & (\bar{\mathbf{u}}_n)^t A \mathbf{u}_3 & \cdots & (\bar{\mathbf{u}}_n)^t A \mathbf{u}_n \end{pmatrix}$. The rest of the proof

follows, as in the proof of theorem 3, with Q^t replaced by Q^* .

18. As $\begin{vmatrix} 1 - \lambda & 1 - i \\ 1 + i & -\lambda \end{vmatrix} = \lambda^2 - \lambda - 2$, the eigenvalues of A are $\lambda_1 = -1$ and $\lambda_2 = 2$. The corresponding

eigenvectors are $\mathbf{v}_1 = \begin{pmatrix} (-1+i)/2 \\ 1 \end{pmatrix}$ and $\mathbf{v}_2 = \begin{pmatrix} 1-i \\ 1 \end{pmatrix}$. As $|\mathbf{v}_1| = \sqrt{3}/2$, and $|\mathbf{v}_2| = \sqrt{3}$, then

$$Q = \begin{pmatrix} (-1+i)/\sqrt{6} & (1-i)/\sqrt{3} \\ \sqrt{2}/3 & 1/\sqrt{3} \end{pmatrix} \text{ and } D = \begin{pmatrix} -1 & 0 \\ 0 & 2 \end{pmatrix}.$$

19. The eigenvalues for $\lambda_1 = -1$ and $\lambda_2 = 8$, with corresponding eigenvectors $\mathbf{v}_1 = \begin{pmatrix} -1+i \\ 1 \end{pmatrix}$ and $\mathbf{v}_2 =$

$$\begin{pmatrix} 1 \\ 1+i \end{pmatrix}. \text{ As } |\mathbf{v}_1| = \sqrt{3} \text{ and } |\mathbf{v}_2| = \sqrt{3}, \text{ then } Q = \begin{pmatrix} (-1+i)/\sqrt{3} & 1/\sqrt{3} \\ 1/\sqrt{3} & (1+i)/\sqrt{3} \end{pmatrix} \text{ and } D = \begin{pmatrix} -1 & 0 \\ 0 & 8 \end{pmatrix}.$$

20. If $A = A^* = \overline{A^t}$, then $\det(A) = \det(A^*) = \det(\overline{A^t}) = \overline{\det(A^t)} = \overline{\det(A)}$, since $\det(A) = \det(A^t)$. Hence $\det(A) = \overline{\det(A)}$ or $\det(A)$ is real.

MATLAB 6.4

1. (a) Because of the random choice, we expect distinct eigenvalues. Since normalization of any eigenvector is just multiplication by a nonzero number, the result is still an eigenvector. The n unit eigenvectors for the distinct eigenvalues will be orthogonal since A is symmetric, and thus these n unit eigenvectors will form an orthonormal basis for \mathbb{R}^n .
- (b) Here is one 3×3 random example.

```
>> B=10*rand(3)-5*ones(3,3); A=triu(B)+triu(B)' % Produce a random symmetric
A =
   -5.6208    1.7930    0.1942
    1.7930    8.6939    3.3097
    0.1942    3.3097   -9.3086
>> [V,D]=eig(A) % Note the eigenvalues for A are distinct, and real.
V =
   -0.9925   -0.0299    0.1182
    0.1111    0.1779    0.9778
    0.0503   -0.9836    0.1733
D =
   -5.8313         0         0
         0   -9.9014         0
         0         0    9.4972
>> V'*V % This yields I, showing V already had orthonormal columns.
ans =
    1.0000    0.0000    0.0000
    0.0000    1.0000    0.0000
    0.0000    0.0000    1.0000
>> Q=V; A-Q*D*Q' % This is zero (up to round-off) so A=QDQ'.
ans =
    1.0e-13 *
    0.0266   -0.0089   -0.0006
   -0.0133   -0.1421         0
   -0.0006         0    0.0533
```

2.

```
>> B=8*rand(4)-4*ones(4,4); C=6*rand(4)-2*ones(4,4); A = B+i*C; % Random A
>> H=triu(A)+triu(A)'
H =
   -4.4967          3.4775 + 1.1616i   -3.7234 + 2.2071i   -3.9384 - 1.7152i
    3.4775 - 1.1616i   -1.8640          -3.5723 + 3.4619i   -0.9327 + 2.4165i
   -3.7234 - 2.2071i   -3.5723 - 3.4619i    0.4752          -3.4653 - 0.0306i
   -3.9384 + 1.7152i   -0.9327 - 2.4165i   -3.4653 + 0.0306i   -1.3202
```

- (a) Inspection shows $H = H^*$ or check via MATLAB:

```
>> H-H' % This is zero so H=H', i.e H is hermitian.
ans =
    0     0     0     0
    0     0     0     0
    0     0     0     0
    0     0     0     0
```

```
>> eig(H) % Find the eigenvalues for H. Note they are all real.
ans =
-10.4644 - 0.0000i
-6.6520 + 0.0000i
 7.2996 + 0.0000i
 2.6111 + 0.0000i
```

- (b) The extension of part 1(a) to the complex case follows immediately from the extensions of Theorems 1,2 and 3, once \mathbb{R}^n is replaced by \mathbb{C}^n . Part 1(b) proceeds as follows:

```
>> [V,D]=eig(H) % For one random Hermitian matrix, use H from part (a)
V =
 0.6522 + 0.0000i  0.4984 + 0.1665i  0.4637 + 0.0259i -0.2332 - 0.1686i
-0.1051 - 0.2730i -0.4880 + 0.5223i  0.5283 - 0.1205i -0.1432 + 0.2991i
 0.4353 - 0.0526i -0.3513 + 0.2708i -0.5355 - 0.4271i -0.2462 - 0.2852i
 0.5071 - 0.1993i -0.1271 + 0.0108i -0.0912 + 0.1152i  0.7443 + 0.3337i
D =
-10.4644 - 0.0000i  0  0  0
 0 -6.6520 + 0.0000i  0  0
 0 0 7.2996 + 0.0000i  0
 0 0 0 2.6111 + 0.0000i

>> % Note that the eigenvalues of the random hermitian H are real and distinct
>> V'*V % This yields I, showing that V is unitary. See page 580.
ans =
 1.0000 0.0000 + 0.0000i 0.0000 + 0.0000i 0.0000 - 0.0000i
 0.0000 - 0.0000i 1.0000 0.0000 + 0.0000i 0.0000 + 0.0000i
 0.0000 - 0.0000i 0.0000 - 0.0000i 1.0000 0.0000 + 0.0000i
 0.0000 + 0.0000i 0.0000 - 0.0000i 0.0000 - 0.0000i 1.0000
>> Q=V; A=Q*D*Q' % This is zero (up to round-off) so A=Q*D*Q'.
ans =
 2.2483 + 2.1206i 0.0000 + 0.0000i 0.0000 + 0.0000i 0.0000 - 0.0000i
-7.1012 + 2.6954i 0.9320 - 1.4482i 0.0000 + 0.0000i 0.0000 + 0.0000i
 5.1543 + 5.7898i 3.7276 + 5.3854i -0.2376 + 2.5732i 0.0000 + 0.0000i
 5.3728 + 1.3618i 3.5804 + 2.9125i 4.8345 - 0.4559i 0.6601 + 1.7958i
```

3. (a) For an orthogonal Q , $1 = \det(Q^t Q) = \det(Q)^2$, using $Q^t Q = I$, and $\det(Q^t) = \det(Q)$. Hence

$\det(Q) = \pm 1$. Now if $\det(Q) = -1$ multiplying a column of a matrix by -1 multiplies the determinant by -1 , so produces a new Q with $\det(Q) = 1$. However, multiplying a column by -1 does not change the length of the column or the fact that it is orthogonal to the other columns. Thus the result is still an orthogonal matrix. Moreover, since -1 times an eigenvector is still an eigenvector for the same eigenvalue, the new orthogonal matrix still has eigenvectors for its columns, and the corresponding eigenvalues are exactly the diagonal elements of D . Hence $Q^t A Q = D$ or $Q D Q^t = A$ for the new orthogonal Q .

- (b) Once we know that the first column of Q can be written as $(\cos(\theta) \sin(\theta))^t$, then there are only two unit vectors orthogonal to this column: $\pm(-\sin(\theta) \cos(\theta))^t$. Since the plus sign choice yields the matrix Q with $\det(Q) = \cos^2(\theta) + \sin^2(\theta) = 1$, and the minus sign choice gives a matrix with determinant -1 , only the given form for Q matches the assumptions. From the form of rotation transformations given on page 470, equation (5), or implicitly in MATLAB 4.8, Problem 9 and MATLAB 4.9, Problem 15, Q is a rotation matrix, corresponding to the transformation of \mathbb{R}^2 given by counterclockwise rotation by an angle θ .

(c) Since $Q^t = Q^{-1}$, one first rotates clockwise by an angle θ , then expands or compresses along the x - and y -axes as indicated by the positive entries in the diagonal matrix D , and then rotates back, that is counterclockwise, by the same angle.

(d) (i)

```
>> A=[7/2 1/2 ; 1/2 7/2]; [Q,D]=eig(A)
Q =
    0.7071    0.7071
   -0.7071    0.7071
D =
     3     0
     0     4
>> atan2(Q(2,1),Q(1,1))*180/pi % atan2(y,x) gives the angle (in radians) for
ans =
   -45
>>                                     % the polar coordinates of (x, y)
```

Rotate clockwise by $\theta = -45^\circ$, expand by 3 along the x -axis and expand by 4 along the y -axis and then rotate counterclockwise by θ . See figures below. This has the same effect as expanding by 3 in the direction of $(1 \ -1)^t$ and expanding by 4 in the direction of $(1 \ 1)^t$.

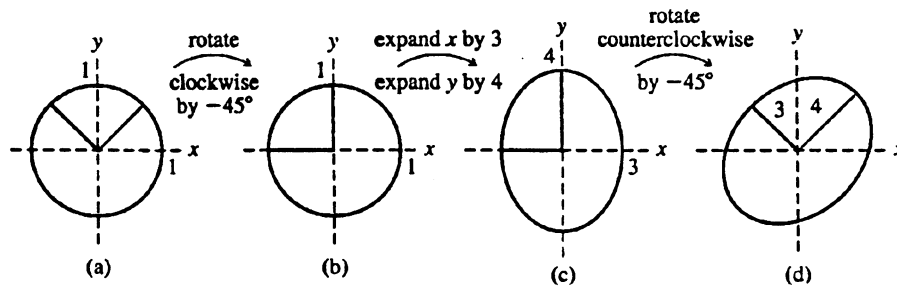

(ii)

```
>> A=[2.75 -.433; -.433 2.25]; [Q,D]=eig(A)
Q =
   -0.8660   -0.5000
    0.5000   -0.8660
D =
   3.0000     0
     0     2.0000
>> atan2(Q(2,1),Q(1,1))*180/pi % atan2(y,x) gives the an angle (in radians) for
ans =
  150.0004
>>                                     % the polar coordinates of (x, y)
```

Rotate clockwise by $\theta \approx 150^\circ$, expand by 3 along the x -axis and expand by 2 along the y -axis, and then rotate counterclockwise by θ . The image of the unit circle is sketched below.

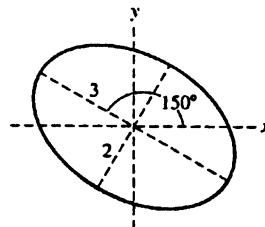

Section 6.5

$$1. \begin{pmatrix} 3 & -1 \\ -1 & 0 \end{pmatrix} \begin{pmatrix} x \\ y \end{pmatrix} \cdot \begin{pmatrix} x \\ y \end{pmatrix} = 5; \begin{vmatrix} 3-\lambda & -1 \\ -1 & -\lambda \end{vmatrix} = \lambda^2 - 3\lambda - 1 = 0 \Rightarrow \lambda = \frac{3 \pm \sqrt{13}}{2}; \mathbf{v}_1 = \begin{pmatrix} 2 \\ 3 - \sqrt{13} \end{pmatrix} \text{ and} \\ \mathbf{v}_2 = \begin{pmatrix} 2 \\ 3 + \sqrt{13} \end{pmatrix}; |\mathbf{v}_1| = \sqrt{26 - 6\sqrt{13}}, |\mathbf{v}_2| = \sqrt{26 + 6\sqrt{13}}; Q = \begin{pmatrix} \frac{2}{\sqrt{26 - 6\sqrt{13}}} & \frac{2}{\sqrt{26 + 6\sqrt{13}}} \\ \frac{2}{\sqrt{26 - 6\sqrt{13}}} & \frac{2}{\sqrt{26 + 6\sqrt{13}}} \end{pmatrix}$$

$$D = \begin{pmatrix} 3 + \sqrt{13} & 0 \\ 0 & 3 - \sqrt{13} \end{pmatrix} \text{ and } \frac{(3 + \sqrt{13})}{2}(x')^2 + \frac{(3 - \sqrt{13})}{2}(y')^2 = 5; \text{ Hyperbola; } \theta \approx 343.15^\circ$$

$$2. \begin{pmatrix} 4 & 2 \\ 2 & 1 \end{pmatrix} \begin{pmatrix} x \\ y \end{pmatrix} \cdot \begin{pmatrix} x \\ y \end{pmatrix} = 9; \begin{vmatrix} 4-\lambda & 2 \\ 2 & 1-\lambda \end{vmatrix} = \lambda^2 - 5\lambda = 0 \Rightarrow \lambda = 0, 5. \mathbf{v}_1 = \begin{pmatrix} 1 \\ -2 \end{pmatrix} \text{ and } \mathbf{v}_2 = \begin{pmatrix} 2 \\ 1 \end{pmatrix}; \\ |\mathbf{v}_1| = \sqrt{5}, |\mathbf{v}_2| = \sqrt{5}; Q = \frac{1}{\sqrt{5}} \begin{pmatrix} 1 & 2 \\ -2 & 1 \end{pmatrix} \quad D = \begin{pmatrix} 0 & 0 \\ 0 & 5 \end{pmatrix} \text{ and } 5(y')^2 = 9; \text{ Pair of straight lines;} \\ \theta \approx 296, .57^\circ.$$

$$3. \begin{pmatrix} 4 & 2 \\ 2 & -1 \end{pmatrix} \begin{pmatrix} x \\ y \end{pmatrix} \cdot \begin{pmatrix} x \\ y \end{pmatrix} = 9; \begin{vmatrix} 4-\lambda & 2 \\ 2 & -1-\lambda \end{vmatrix} = \lambda^2 - 3\lambda - 8 = 0 \Rightarrow \lambda = \frac{3 \pm \sqrt{41}}{2}. \mathbf{v}_1 = \begin{pmatrix} 5 + \sqrt{41} \\ 4 \end{pmatrix} \text{ and} \\ \mathbf{v}_2 = \begin{pmatrix} 5 - \sqrt{41} \\ 4 \end{pmatrix}; |\mathbf{v}_1| = \sqrt{82 + 10\sqrt{41}}, |\mathbf{v}_2| = \sqrt{82 - 10\sqrt{41}}; Q = \begin{pmatrix} \frac{5 + \sqrt{41}}{\sqrt{82 + 10\sqrt{41}}} & \frac{5 - \sqrt{41}}{\sqrt{82 - 10\sqrt{41}}} \\ \frac{5 + \sqrt{41}}{\sqrt{82 + 10\sqrt{41}}} & \frac{5 - \sqrt{41}}{\sqrt{82 - 10\sqrt{41}}} \end{pmatrix}$$

$$D = \frac{1}{2} \begin{pmatrix} 3 + \sqrt{41} & 0 \\ 0 & 3 - \sqrt{41} \end{pmatrix} \text{ and } \frac{(3 + \sqrt{41})}{2}(x')^2 + \frac{(3 - \sqrt{41})}{2}(y')^2 = 9; \text{ Hyperbola; } \theta = 19.33^\circ.$$

$$4. \begin{pmatrix} 0 & 1/2 \\ 1/2 & 0 \end{pmatrix} \begin{pmatrix} x \\ y \end{pmatrix} \cdot \begin{pmatrix} x \\ y \end{pmatrix} = 1; \begin{vmatrix} -\lambda & 1/2 \\ 1/2 & -\lambda \end{vmatrix} = \lambda^2 - 1/4 = 0 \Rightarrow \lambda = \pm 1/2. \mathbf{v}_1 = \begin{pmatrix} 1 \\ 1 \end{pmatrix} \text{ and } \mathbf{v}_2 = \begin{pmatrix} -1 \\ 1 \end{pmatrix}; \\ |\mathbf{v}_1| = \sqrt{2}, |\mathbf{v}_2| = \sqrt{2}; Q = \frac{1}{\sqrt{2}} \begin{pmatrix} 1 & -1 \\ 1 & 1 \end{pmatrix} \quad D = \begin{pmatrix} 1/2 & 0 \\ 0 & -1/2 \end{pmatrix} \text{ and } \frac{(x')^2}{2} - \frac{(y')^2}{2} = 1 \text{ Hyperbola;} \\ \theta \approx 45^\circ.$$

$$5. \begin{pmatrix} 0 & 1/2 \\ 1/2 & 0 \end{pmatrix} \begin{pmatrix} x \\ y \end{pmatrix} \cdot \begin{pmatrix} x \\ y \end{pmatrix} = a; \begin{vmatrix} -\lambda & 1/2 \\ 1/2 & -\lambda \end{vmatrix} = \lambda^2 - 1/4 = 0 \Rightarrow \lambda = \pm 1/2. \mathbf{v}_1 = \begin{pmatrix} 1 \\ 1 \end{pmatrix} \text{ and } \mathbf{v}_2 = \begin{pmatrix} -1 \\ 1 \end{pmatrix}; \\ |\mathbf{v}_1| = \sqrt{2}; |\mathbf{v}_2| = \sqrt{2}; Q = \frac{1}{\sqrt{2}} \begin{pmatrix} 1 & -1 \\ 1 & 1 \end{pmatrix} \quad D = \begin{pmatrix} 1/2 & 0 \\ 0 & -1/2 \end{pmatrix} \text{ and } \frac{(x')^2}{2} - \frac{(y')^2}{2} = a. \text{ Hyperbola;} \\ \theta \approx 315^\circ.$$

$$6. \begin{pmatrix} 4 & 1 \\ 1 & 3 \end{pmatrix} \begin{pmatrix} x \\ y \end{pmatrix} \cdot \begin{pmatrix} x \\ y \end{pmatrix} = -2; \begin{vmatrix} 4-\lambda & 1 \\ 1 & 3-\lambda \end{vmatrix} = \lambda^2 - 7\lambda + 11 = 0 \Rightarrow \lambda = \frac{7 \pm \sqrt{5}}{2}; \mathbf{v}_1 = \begin{pmatrix} -1 + \sqrt{5} \\ 2 \end{pmatrix} \\ \text{and } \mathbf{v}_2 = \begin{pmatrix} -1 - \sqrt{5} \\ 2 \end{pmatrix}; |\mathbf{v}_1| = \sqrt{10 - 2\sqrt{5}}, |\mathbf{v}_2| = \sqrt{10 + 2\sqrt{5}}; Q = \begin{pmatrix} \frac{-1 + \sqrt{5}}{\sqrt{10 - 2\sqrt{5}}} & \frac{-1 - \sqrt{5}}{\sqrt{10 + 2\sqrt{5}}} \\ \frac{-1 + \sqrt{5}}{\sqrt{10 - 2\sqrt{5}}} & \frac{-1 - \sqrt{5}}{\sqrt{10 + 2\sqrt{5}}} \end{pmatrix}$$

$$D = \begin{pmatrix} (7 + \sqrt{5})/2 & 0 \\ 0 & (7 - \sqrt{5})/2 \end{pmatrix} \text{ and } \frac{(7 + \sqrt{5})}{2}(x')^2 + \frac{(7 - \sqrt{5})}{2}(y')^2 = -2; \text{ Degenerate conic section.}$$

7. Same as problem 5 except that the roles of x' and y' are reversed since $a < 0$.

8. $\begin{pmatrix} 1 & 2 \\ 2 & 4 \end{pmatrix} \begin{pmatrix} x \\ y \end{pmatrix} \cdot \begin{pmatrix} x \\ y \end{pmatrix} = 6$; $\begin{vmatrix} 1-\lambda & 2 \\ 2 & 4-\lambda \end{vmatrix} = \lambda^2 - 5\lambda = 0 \Rightarrow \lambda = 0, 5$; $\mathbf{v}_1 = \begin{pmatrix} 2 \\ -1 \end{pmatrix}$ and $\mathbf{v}_2 = \begin{pmatrix} 1 \\ 2 \end{pmatrix}$;
 $|\mathbf{v}_1| = \sqrt{5}$, $|\mathbf{v}_2| = \sqrt{5}$; $Q = \frac{1}{\sqrt{5}} \begin{pmatrix} 2 & 1 \\ -1 & 2 \end{pmatrix}$ $D = \begin{pmatrix} 0 & 0 \\ 0 & 5 \end{pmatrix}$ and $5(y')^2 = 6$; Pair of straight lines;
 $\theta \approx 333.43^\circ$.
9. $\begin{pmatrix} -1 & 1 \\ 1 & -1 \end{pmatrix} \begin{pmatrix} x \\ y \end{pmatrix} \cdot \begin{pmatrix} x \\ y \end{pmatrix} = 0$; $\begin{vmatrix} -1-\lambda & 1 \\ 1 & -1-\lambda \end{vmatrix} = \lambda^2 + 2\lambda = 0 \Rightarrow \lambda = 0, -2$; $\mathbf{v}_1 = \begin{pmatrix} 1 \\ 1 \end{pmatrix}$ and
 $\mathbf{v}_2 = \begin{pmatrix} -1 \\ 1 \end{pmatrix}$; $|\mathbf{v}_1| = \sqrt{2}$, $|\mathbf{v}_2| = \sqrt{2}$; $Q = \frac{1}{\sqrt{2}} \begin{pmatrix} 1 & -1 \\ 1 & 1 \end{pmatrix}$ $D = \begin{pmatrix} 0 & 0 \\ 0 & -2 \end{pmatrix}$ and $-2(y')^2 = 0$; Single
straight line; $\theta = 45^\circ$.
10. $\begin{pmatrix} 2 & 1/2 \\ 1/2 & 1 \end{pmatrix} \begin{pmatrix} x \\ y \end{pmatrix} \cdot \begin{pmatrix} x \\ y \end{pmatrix} = 4$; $\begin{vmatrix} 2-\lambda & 1/2 \\ 1/2 & 1-\lambda \end{vmatrix} = \lambda^2 - 3\lambda + 7/4 = 0 \Rightarrow \lambda = \frac{3 \pm \sqrt{2}}{2}$; $\mathbf{v}_1 = \begin{pmatrix} 1 + \sqrt{2} \\ 1 \end{pmatrix}$
and $\mathbf{v}_2 = \begin{pmatrix} 1 - \sqrt{2} \\ 1 \end{pmatrix}$; $|\mathbf{v}_1| = \sqrt{4 + 2\sqrt{2}}$, $|\mathbf{v}_2| = \sqrt{4 - 2\sqrt{2}}$; $Q = \begin{pmatrix} \frac{-1 + \sqrt{2}}{\sqrt{4 + 2\sqrt{2}}} & \frac{1 - \sqrt{2}}{\sqrt{4 - 2\sqrt{2}}} \\ \frac{1}{\sqrt{4 + 2\sqrt{2}}} & \frac{1}{\sqrt{4 - 2\sqrt{2}}} \end{pmatrix}$ $D =$
 $\begin{pmatrix} 3 + \sqrt{2} & 0 \\ 0 & 3 - \sqrt{2} \end{pmatrix}$ and $\frac{(3 + \sqrt{2})}{2}(x')^2 + \frac{(3 - \sqrt{2})}{2}(y')^2 = 4$; Ellipse; $\theta = 22.5^\circ$.
11. $\begin{pmatrix} 3 & -3 \\ -3 & 5 \end{pmatrix} \begin{pmatrix} x \\ y \end{pmatrix} \cdot \begin{pmatrix} x \\ y \end{pmatrix} = 36$; $\begin{vmatrix} 3-\lambda & -3 \\ -3 & 5-\lambda \end{vmatrix} = \lambda^2 - 8\lambda + 6 = 0 \Rightarrow \lambda = 4 \pm \sqrt{10}$; $\mathbf{v}_1 = \begin{pmatrix} 1 + \sqrt{10} \\ 3 \end{pmatrix}$
and $\mathbf{v}_2 = \begin{pmatrix} 1 - \sqrt{10} \\ 3 \end{pmatrix}$; $|\mathbf{v}_1| = \sqrt{20 + 2\sqrt{10}}$, $|\mathbf{v}_2| = \sqrt{20 - 2\sqrt{10}}$; $Q = \begin{pmatrix} \frac{1 + \sqrt{10}}{\sqrt{20 + 2\sqrt{10}}} & \frac{1 - \sqrt{10}}{\sqrt{20 - 2\sqrt{10}}} \\ \frac{1}{\sqrt{20 + 2\sqrt{10}}} & \frac{1}{\sqrt{20 - 2\sqrt{10}}} \end{pmatrix}$
 $D = \begin{pmatrix} 4 - \sqrt{10} & 0 \\ 0 & 4 + \sqrt{10} \end{pmatrix}$ and $(4 - \sqrt{10})(x')^2 + (4 + \sqrt{10})(y')^2 = 36$; Ellipse; $\theta \approx 35.78^\circ$.
12. $\begin{pmatrix} 1 & -3/2 \\ -3/2 & 4 \end{pmatrix} \begin{pmatrix} x \\ y \end{pmatrix} \cdot \begin{pmatrix} x \\ y \end{pmatrix} = 1$; $\begin{vmatrix} 1-\lambda & -3/2 \\ -3/2 & 4-\lambda \end{vmatrix} = \lambda^2 - 5\lambda + 7/4 = 0 \Rightarrow \lambda = \frac{5 \pm 3\sqrt{2}}{2}$; $\mathbf{v}_1 = \begin{pmatrix} -1 + \sqrt{2} \\ -1 \end{pmatrix}$
and $\mathbf{v}_2 = \begin{pmatrix} 1 + \sqrt{2} \\ 1 \end{pmatrix}$; $|\mathbf{v}_1| = \sqrt{4 - 2\sqrt{2}}$, $|\mathbf{v}_2| = \sqrt{4 + 2\sqrt{2}}$; $Q = \begin{pmatrix} \frac{-1 + \sqrt{2}}{\sqrt{4 - 2\sqrt{2}}} & \frac{1 + \sqrt{2}}{\sqrt{4 + 2\sqrt{2}}} \\ -1 & 1 \end{pmatrix}$ $D =$
 $\begin{pmatrix} 5 + 3\sqrt{2} & 0 \\ 0 & 5 - 3\sqrt{2} \end{pmatrix}$ and $\frac{(5 + 3\sqrt{2})}{2}(x')^2 + \frac{(5 - 3\sqrt{2})}{2}(y')^2 = 1$; Ellipse; $\theta = 292.5^\circ$.
13. $\begin{pmatrix} 6 & 5/2 \\ 5/2 & -6 \end{pmatrix} \begin{pmatrix} x \\ y \end{pmatrix} \cdot \begin{pmatrix} x \\ y \end{pmatrix} = -7$; $\begin{vmatrix} 6-\lambda & 5/2 \\ 5/2 & -6-\lambda \end{vmatrix} = \lambda^2 - \frac{169}{4} = 0 \Rightarrow \lambda = \pm 13/2$; $\mathbf{v}_1 = \begin{pmatrix} 5 \\ 1 \end{pmatrix}$ and $\mathbf{v}_2 =$
 $\begin{pmatrix} -1 \\ 5 \end{pmatrix}$; $|\mathbf{v}_1| = \sqrt{26}$, $|\mathbf{v}_2| = \sqrt{26}$; $Q = \frac{1}{\sqrt{26}} \begin{pmatrix} 5 & -1 \\ 1 & 5 \end{pmatrix}$ $D = \begin{pmatrix} 13 & 0 \\ 0 & -13 \end{pmatrix}$ and
 $\frac{13(x')^2}{2} - \frac{13(y')^2}{2} = -7$. Hyperbola; $\theta \approx 11.31^\circ$.
14. Two straight lines, a single straight line, or a single point.
15. $\begin{pmatrix} 1 & -1 & -1 \\ -1 & 1 & -1 \\ -1 & -1 & 1 \end{pmatrix} \begin{pmatrix} x \\ y \\ z \end{pmatrix} \cdot \begin{pmatrix} x \\ y \\ z \end{pmatrix}$; $\begin{vmatrix} 1-\lambda & -1 & -1 \\ -1 & 1-\lambda & -1 \\ -1 & -1 & 1-\lambda \end{vmatrix} = -4 + 3\lambda^2 - \lambda^3 = 0 \Rightarrow \lambda = -1, 2, 2$. $\begin{pmatrix} -1 & 0 & 0 \\ 0 & 2 & 0 \\ 0 & 0 & 2 \end{pmatrix}$;
 $-(x')^2 + 2(y')^2 + 2(z')^2$.

$$16. \begin{pmatrix} -1 & 2 & 2 \\ 2 & -1 & 2 \\ 2 & 2 & 1 \end{pmatrix} \begin{pmatrix} x \\ y \\ z \end{pmatrix} \cdot \begin{pmatrix} x \\ y \\ z \end{pmatrix}; \quad \begin{vmatrix} -1-\lambda & 2 & 2 \\ 2 & -1-\lambda & 2 \\ 2 & 2 & 1-\lambda \end{vmatrix} = 21 + 3\lambda - \lambda^2 - \lambda^3 = 0 \Rightarrow \lambda = -3, \frac{2 \pm \sqrt{77}}{2};$$

$$\begin{pmatrix} -3 & 0 & 0 \\ 0 & \frac{2 \pm \sqrt{77}}{2} & 0 \\ 0 & 0 & \frac{2 - \sqrt{77}}{2} \end{pmatrix}; -3(x')^2 + \frac{(2 + \sqrt{77})}{2}(y')^2 + \frac{(2 - \sqrt{77})}{2}(z')^2.$$

$$17. \begin{pmatrix} 3 & 2 & 2 \\ 2 & 2 & 0 \\ 2 & 0 & 4 \end{pmatrix} \begin{pmatrix} x \\ y \\ z \end{pmatrix} \cdot \begin{pmatrix} x \\ y \\ z \end{pmatrix}; \quad \begin{vmatrix} 3-\lambda & 2 & 2 \\ 2 & 2-\lambda & 0 \\ 2 & 0 & 4-\lambda \end{vmatrix} = -18\lambda + 9\lambda^2 - \lambda^3 = 0 \Rightarrow \lambda = 0, 3, 6; \quad \begin{pmatrix} 0 & 0 & 0 \\ 0 & 3 & 0 \\ 0 & 0 & 6 \end{pmatrix};$$

$$3(y')^2 + 6(z')^2.$$

$$18. \begin{pmatrix} 1 & -1 & 0 \\ -1 & 2 & -1 \\ 0 & -1 & 1 \end{pmatrix} \begin{pmatrix} x \\ y \\ z \end{pmatrix} \cdot \begin{pmatrix} x \\ y \\ z \end{pmatrix}; \quad \begin{vmatrix} 1-\lambda & -1 & 0 \\ -1 & 2-\lambda & -1 \\ 0 & -1 & 1-\lambda \end{vmatrix} = -3\lambda + 4\lambda^2 - \lambda^3 = 0 \Rightarrow \lambda = 0, 1, 3; \quad \begin{pmatrix} 0 & 0 & 0 \\ 0 & 1 & 0 \\ 0 & 0 & 3 \end{pmatrix};$$

$$(y')^2 + 3(z')^2.$$

$$19. \begin{pmatrix} 1 & 1 & 2 & 7/2 \\ 1 & 1 & 3 & -1 \\ 2 & 3 & 3 & 0 \\ 7/2 & -1 & 0 & 1 \end{pmatrix} \quad 20. \begin{pmatrix} 1 & 0 & 1/2 & 0 \\ 0 & 1 & 0 & -1/2 \\ 1/2 & 0 & 0 & 0 \\ 0 & -1/2 & 0 & 1 \end{pmatrix} \quad 21. \begin{pmatrix} 3 & -7/2 & 1/2 & -1 & 3/2 \\ -7/2 & -2 & -1/2 & 1/2 & 0 \\ 1/2 & -1/2 & 3 & -2 & -5/2 \\ -1 & 1/2 & -2 & -6 & 1/2 \\ 3/2 & 0 & -5/2 & 1/2 & -1 \end{pmatrix}$$

22. Note that $\det A < 0$ since we have a hyperbola. Then $\det A < 0$ regardless of the value of d . Thus the equation represents a hyperbola for any nonzero value of d by Theorem 2, i .

23. $\begin{pmatrix} \cos \theta & -\sin \theta \\ \sin \theta & \cos \theta \end{pmatrix} \begin{pmatrix} x \\ y \end{pmatrix} = \begin{pmatrix} x \cos \theta - y \sin \theta \\ x \sin \theta + y \cos \theta \end{pmatrix} = \begin{pmatrix} x' \\ y' \end{pmatrix}$. Then $a(x')^2 + bx'y' + c(y')^2 = a(x \cos \theta - y \sin \theta)^2 + b(x \cos \theta - y \sin \theta)(x \sin \theta + y \cos \theta) + c(x \sin \theta + y \cos \theta)^2$. Then the coefficient of the xy -term is $(-2a \sin \theta \cos \theta + b \cos^2 \theta - b \sin^2 \theta + 2c \sin \theta \cos \theta) = (c - a)(2 \sin \theta \cos \theta) + b(\cos^2 \theta - \sin^2 \theta)$. This is 0 if $(c - a) \sin 2\theta + b \cos 2\theta = 0$, or $b \cos 2\theta = (a - c) \sin 2\theta$. So $\cot 2\theta = (a - c)/b$.

24. If $a = c$ then $\cot 2\theta = 0$ which implies that $2\theta = \pm\pi/2$. Then $\theta = \pm\pi/4$.

25. Let $A = \begin{pmatrix} a & b/2 \\ b/2 & a \end{pmatrix}$ and $A' = \begin{pmatrix} a' & b'/2 \\ b'/2 & c' \end{pmatrix}$. Then there exists a unique orthogonal matrix Q such that $A = QA'Q^t$. Then A and A' are similar. Thus they have the same characteristic polynomials. But $\det(A - \lambda I) = A^2 - (a + c)\lambda + (ac - b^2/4) = \lambda^2 - (a' + c')\lambda + (a'c' - b'^2/4)$.

a) So $a + c = a' + c'$ from equality of λ terms.

b) $b^2 - 4ac = b'^2 - 4a'c'$ from equality of constant terms.

26. $F(\mathbf{x}) = A\mathbf{x} \cdot \mathbf{x} = D\mathbf{x}' \cdot \mathbf{x}'$. $D = \text{diag}(\lambda_1, \lambda_2, \dots, \lambda_n)$. But if $D\mathbf{x}' \cdot \mathbf{x}'$ is to be greater than or equal to zero for all $\mathbf{x}' \in \mathbb{R}^n$, then $\lambda_i \geq 0$, $1 \leq i \leq n$. If $D\mathbf{x}' \cdot \mathbf{x}' > 0$ for all $\mathbf{x}' \neq 0$, then $De_1 \cdot e_1 = \lambda_1 > 0$, $De_2 \cdot e_2 = \lambda_2 > 0, \dots, De_n \cdot e_n = \lambda_n > 0$. If $\lambda_i > 0$, $1 \leq i \leq n$, then $D\mathbf{x}' \cdot \mathbf{x}' = \lambda_1(x'_1)^2 + \dots + \lambda_n(x'_n)^2 = F(\mathbf{x}) \geq 0$, for all $\mathbf{x} \in \mathbb{R}^n$ and $F(\mathbf{x}) = 0$ if and only if $\mathbf{x} = 0$. Thus $F(\mathbf{x})$ is positive definite if and only if A has positive eigenvalues.

27. In problem 26, it is shown that $F(\mathbf{x}) \geq 0 \Rightarrow \lambda_i \geq 0$, $1 \leq i \leq n$. If $\lambda_i \geq 0$ then $F(\mathbf{x}) = D\mathbf{x}' \cdot \mathbf{x}' = \lambda_1(x'_1)^2 + \dots + \lambda_n(x'_n)^2$. Then $F(\mathbf{x}) \geq 0$ for all $\mathbf{x} \in \mathbb{R}^n$. Thus $F(\mathbf{x})$ is positive semidefinite if and only if the eigenvalues of A are nonnegative.

28. $A = \begin{pmatrix} 3 & 0 \\ 0 & 2 \end{pmatrix}$; $\lambda = 2, 3$; A is positive definite.

29. $A = \begin{pmatrix} -3 & 0 \\ 0 & -3 \end{pmatrix}$; $\lambda = -3, -3$; A is negative definite.

30. $A = \begin{pmatrix} 3 & 0 \\ 0 & -2 \end{pmatrix}$; $\lambda = -2, 3$; A is indefinite.

31. $A = \begin{pmatrix} 1 & 1 \\ 1 & 2 \end{pmatrix}$; $\lambda = (3 \pm \sqrt{5})/2$; A is positive definite.

32. $A = \begin{pmatrix} 1 & -1 \\ -1 & 2 \end{pmatrix}$; $\lambda = (3 \pm \sqrt{5})/2$; A is positive definite.

33. $A = \begin{pmatrix} 1 & -2 \\ -2 & 3 \end{pmatrix}$; $\lambda = 2 \pm \sqrt{5}$; A is indefinite.

34. $A = \begin{pmatrix} -1 & 2 \\ 2 & -3 \end{pmatrix}$; $\lambda = -2 \pm \sqrt{5}$; A is indefinite.

35. $A = \begin{pmatrix} -1 & 1 \\ 1 & -2 \end{pmatrix}$; $\lambda = (-3 \pm \sqrt{5})/2$; A is negative definite.

36. $\det Q = ad - bc = 1$. $Q^t Q = \begin{pmatrix} a^2 + c^2 & ab + cd \\ ab + cd & b^2 + d^2 \end{pmatrix} = \begin{pmatrix} 1 & 0 \\ 0 & 1 \end{pmatrix}$. $\left. \begin{matrix} ad - bc = 1 \\ ab + cd = 0 \end{matrix} \right\} \Rightarrow c(b^2 + d^2) = -b \Rightarrow b = -c$

since $b^2 + d^2 = 1$. Then $-ac + cd = 0 \Rightarrow ac = cd \Rightarrow a = d$, provided $c \neq 0$. If $c = 0$ then $a^2 - 1 \Rightarrow a = \pm 1$, and $\det Q = ad = 1 \Rightarrow d = 1/a$. Then $d = a$. Since $a^2 + c^2 = 1$, $a = \cos \theta$ and

$c = \sin \theta$ for some $\theta \in [0, 2\pi)$. Then $Q = \begin{pmatrix} \cos \theta & -\sin \theta \\ \sin \theta & \cos \theta \end{pmatrix}$.

(a) If $a \geq 0$ and $c > 0$, then $0 < \theta \leq \pi/2$ and $\theta = \cos^{-1} a$.

(b) If $a \geq 0$ and $c < 0$, then $3\pi/2 \leq \theta < 2\pi$ and $\theta = 2\pi - \cos^{-1} a$.

(c) If $a \leq 0$ and $c > 0$, then $\pi/2 \leq \theta < \pi$ and $\theta = \cos^{-1} a$.

(d) If $a \leq 0$ and $c < 0$, then $\pi < \theta \leq 3\pi/2$ and $\theta = 2\pi - \cos^{-1} a$.

(e) If $a = 1$ and $c = 0$, then $\theta = \cos^{-1}(1) = \sin^{-1}(0) = 0$.

(f) If $a = -1$ and $c = 0$, then $\theta = \cos^{-1}(-1) = \pi$.

37. (This problem, and part (v) are slightly wrong. $\det A \neq 0, d = 0$ yields either a single point if $\det A > 0$ or two straight lines if $\det A < 0$.) If $\det A \neq 0$ then $\lambda_1 \neq 0$ and $\lambda_2 \neq 0$. If λ_1 and λ_2 have opposite signs then we have $\lambda_1(x')^2 + \lambda_2(y')^2 = 0 \Rightarrow y' = \pm \sqrt{-\lambda_1/\lambda_2} x'$. This represents two straight lines through the origin with slope $\pm \sqrt{-\lambda_1/\lambda_2}$. If λ_1 and λ_2 have the same sign then the only solution is $x' = 0$ and $y' = 0$. These are the equations of a point. If $\det A = d = 0$ then either $\lambda_1 = 0$ or $\lambda_2 = 0$. If $\lambda_1 = 0$ then we have $\lambda_2(y')^2 = 0 \Rightarrow y' = 0$, which is a straight line. If $\lambda_2 = 0$ then we have $x' = 0$, which is a straight line. Note both $\lambda_1 = \lambda_2 = 0$, does not correspond to a true curve; we have all x, y .

38. (a) Equation (1) is a hyperbola if $\det A = \lambda_1 \lambda_2 < 0$. (This uses $\det(A) =$ product of eigenvalues).
 (b) Equation (1) is an ellipse, circle or degenerate conic (possibly empty or a single point) section if $\det A = \lambda_1 \lambda_2 > 0$.

MATLAB 6.5

1. For problem 10: $2x^2 + xy + y^2 = 4$

(a) Using the formula from Theorem 2 we see

```
>> A=[2 1/2; 1/2 1];           % So (Av)'v=4, v=(x y)' is the given equation.
```

(b)

```
>> [Q,D]=eig(A)
Q =
  -0.9239    0.3827
  -0.3827   -0.9239
D =
  2.2071     0
     0    0.7929
```

(c)

```
>> det(Q)                       % det(Q) is one, so just find angle of column 1
ans =
  1.0000
>> theta=atan2(Q(2,1),Q(1,1)) % atan2(y,x) gives polar angle of (x,y)
theta =
  -2.7489
>> theta*180/pi                 % Convert to degrees
ans =
  -157.5000
>> ans+360                      % To give a rotation angle in [0,360)
ans =
  202.5000
```

(d) The equation in the new coordinates is $2.2071x'^2 + .7929y'^2 = 4$. It is an ellipse.

```
>> det(A)                       % det(A)>0 for this ellipse,
ans =                             % so Theorem 2 is verified.
  1.7500
```

(e) The picture below shows the ellipse with major and minor axes along the eigenvectors (with angles $\theta = 292.5^\circ$ and $\theta = 202.5$ and $\sqrt{(d/\lambda_i)}, i = 1, 2$ as the lengths of the semi-major and semi-minor axes. The foci are at $x' = \pm\sqrt{d(\lambda_1^{-1} - \lambda_2^{-1})}, y' = 0$.

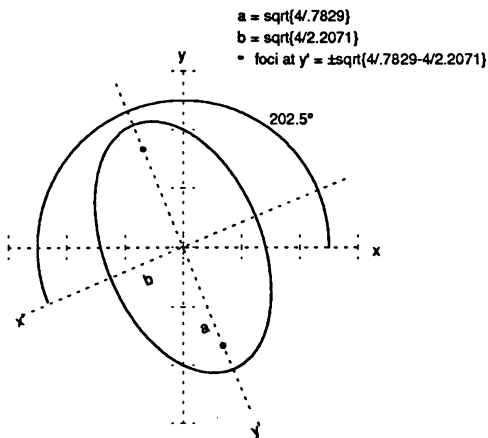

2. For problem 8: $x^2 + 4xy + 4y^2 - 6 = 0$

(a) Using the formula from Theorem 2 we see

```
>> A=[1 2; 2 4];           % So (Av)'v=6, v=(x y)' is the given equation.
```

(b)

```
>> [Q,D]=eig(A)
Q =
    0.8944    0.4472
   -0.4472    0.8944
D =
     0     0
     0     5
```

(c)

```
>> det(Q)                   % det(Q) is one, so just find angle of column 1
ans =
    1.0000
>> theta=atan2(Q(2,1),Q(1,1)) % atan2(y,x) gives polar angle of (x,y)
theta =
   -0.4636
>> theta*180/pi             % Convert to degrees
ans =
   -26.5651
>> ans+360                  % To give a rotation angle in [0,360)
ans =
   333.4349
```

(d) The equation in the new coordinates is $5y'^2 = 6$, which represents two straight lines.

```
>> det(A)                   % det(A)=0, with d=6,
ans =                        % so case iii of Theorem 2 applies
     0
```

(e) A picture would show two straight lines, at $y' = \pm\sqrt{6/5}$. The distance of each of these lines from the origin is $\sqrt{(d/\lambda_2)}$, where $\lambda_2 = 5$ is the one nonzero eigenvalue. The inclination of these lines (angle between the x -axis and the lines) is -26.5651° , and the normal to these lines is given by $\mathbf{u}_2 = Q(:, 2)$, the eigenvector for λ_2 .

3. For problem 4: $xy = 1$

(a) Using the formula from Theorem 2 we see

```
>> A=[0 1/2; 1/2 0];       % So (Av)'v=1, v=(x y)' is the given equation.
```

(b)

```
>> [Q,D]=eig(A)
Q =
    0.7071    0.7071
   -0.7071    0.7071
D =
   -0.5000     0
     0     0.5000
```

(c)

```

>> det(Q)                % det(Q) is one, so just find angle of column 1
ans =
    1.0000
>> theta=atan2(Q(2,1),Q(1,1)) % atan2(y,x) gives polar angle of (x,y)
theta =
   -0.7854
>> theta*180/pi          % Convert to degrees
ans =
   -45
>> ans+360               % To give a rotation angle in [0,360)
ans =
    315
    
```

(d) The equation in the new coordinates is $-.5x'^2 + .5y'^2 = 1$, which represents an hyperbola.

```

>> det(A)                % Since det(A)<0, Theorem 2 is verified.
ans =
   -0.2500
    
```

(e) The picture below shows the hyperbola with its axis along the eigenvector $u_2 = Q(:, 2)$ for $\lambda_2 = .5$ at angle $\theta = 45^\circ$ and $\sqrt{d/\lambda_2}$ as the distance from the origin to the vertices of the hyperbola.

The foci of the hyperbola are at $\sqrt{d(\lambda_2^{-1} - \lambda_1^{-1})}$ along the y' -axis and the width of the opening along the lines through the foci perpendicular to the axis (i.e. in the x' direction) is $2\sqrt{d/(-\lambda_1)}$.

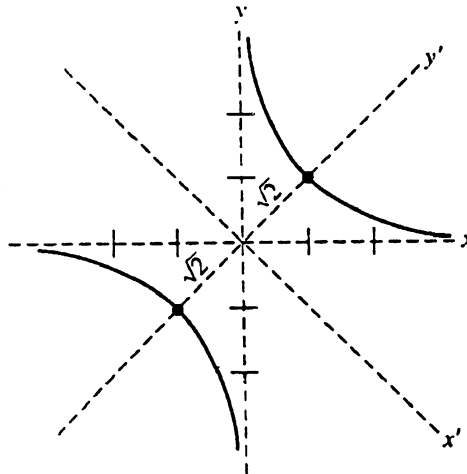

4. For problem 12: $x^2 - 3xy + 4y^2 = 1$

(a) Using the formula from Theorem 2 we see

```

>> A=[1 -3/2; -3/2 4];    % So (Av)'v=1, v=(x y)' is the given equation.
    
```

(b)

```

>> [Q,D]=eig(A)
Q =
    0.9239   -0.3827
    0.3827    0.9239
D =
    0.3787     0
     0     4.6213
    
```

(c)

```

>> det(Q)                % det(Q) is one, so just find angle of column 1
ans =
    1.0000
>> theta=atan2(Q(2,1),Q(1,1)) % atan2(y,x) gives polar angle of (x,y)
theta =
    0.3927
>> theta*180/pi          % Convert to degrees
ans =
    22.5000

```

(d) The equation in the new coordinates is $.3787x'^2 + 4.6213y'^2 = 1$. It is an ellipse.

```

>> det(A)                % Since det(A)>0, Theorem 2 is verified.
ans =
    1.7500

```

(e) The picture below shows the (rotated) ellipse with the major and minor axes along the eigenvectors at angles $\theta = 22.5^\circ$ and $\theta = 112.5^\circ$ and $\sqrt{(d/\lambda_i)}, i = 1, 2$ as the lengths of the semi-major and semi-minor axes. The foci are on the x' -axis at $x' = \pm\sqrt{d/\lambda_1 - d/\lambda_2}$

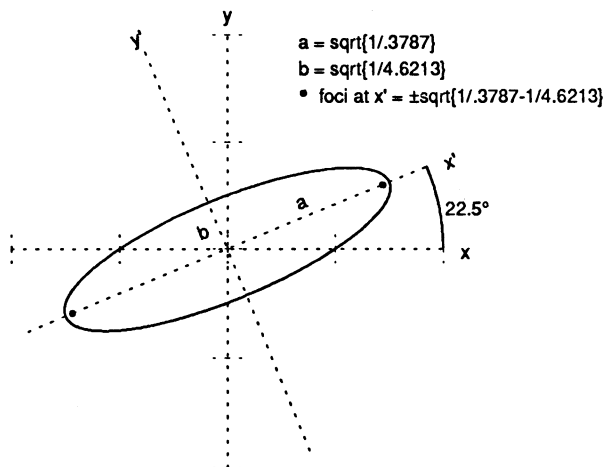

Section 6.6

1. no 2. yes 3. no 4. yes 5. yes
 6. no 7. no 8. no 9. yes 10. yes
 11. no 12. yes 13. yes 14. yes
15. The matrix is a Jordan matrix, so $C = I$ works.
16. The matrix has $\lambda = -5$ as an eigenvalue of algebraic multiplicity 2. Upon solving $(A + 5I)\mathbf{v} = 0$, we find $\mathbf{v}_1 = \begin{pmatrix} 1 \\ 1 \end{pmatrix}$ as an eigenvector. As there are no other linearly independent eigenvectors, we solve $(A + 5I)\mathbf{v}_2 = \mathbf{v}_1$ to find $\mathbf{v}_2 = \begin{pmatrix} 6/7 \\ 1 \end{pmatrix}$ as a generalized eigenvector. Thus $C = \begin{pmatrix} 1 & 6/7 \\ 1 & 1 \end{pmatrix}$ and $J = \begin{pmatrix} -5 & 1 \\ 0 & -5 \end{pmatrix}$.
17. The matrix has $\lambda = -3$ as an eigenvalue of algebraic multiplicity 2. We solve $(A + 3I)\mathbf{v} = 0$ to find $\mathbf{v}_1 = \begin{pmatrix} 1 \\ -1 \end{pmatrix}$ as an eigenvector. Since there are no other linearly independent eigenvectors, we solve $(A + 3I)\mathbf{v}_2 = \mathbf{v}_1$ to find $\mathbf{v}_2 = \begin{pmatrix} -8/7 \\ 1 \end{pmatrix}$ as a generalized eigenvector. Hence $C = \begin{pmatrix} 1 & -8/7 \\ -1 & 1 \end{pmatrix}$ and $J = \begin{pmatrix} -3 & 1 \\ 0 & -3 \end{pmatrix}$.
18. The matrix has $\lambda = 3$ as an eigenvalue of algebraic multiplicity 2. Upon solving $(A - 3I)\mathbf{v} = 0$, we find $\mathbf{v}_1 = \begin{pmatrix} 1 \\ 1 \end{pmatrix}$ as an eigenvector. As there are no other linearly independent eigenvectors, we solve $(A - 3I)\mathbf{v}_2 = \mathbf{v}_1$ to find $\mathbf{v}_2 = \begin{pmatrix} 1 \\ 0 \end{pmatrix}$ as a generalized eigenvector. So $C = \begin{pmatrix} 1 & 1 \\ 1 & 0 \end{pmatrix}$ and $J = \begin{pmatrix} 3 & 1 \\ 0 & 3 \end{pmatrix}$.
19. (a) Expand $\{\mathbf{v}_1\}$ to a basis $\{\mathbf{v}_1, \mathbf{x}, \mathbf{y}\}$ of \mathbb{C}^3 . Then $A = \begin{pmatrix} \lambda & a & c \\ 0 & b_{11} & b_{12} \\ 0 & b_{21} & b_{22} \end{pmatrix}$ with respect to this basis. Now the matrix $B = \begin{pmatrix} b_{11} & b_{12} \\ b_{21} & b_{22} \end{pmatrix}$ has $p(t) = (t - \lambda)^2$ as its characteristic polynomial, and λ as an eigenvalue of algebraic multiplicity 2. Note that for B , λ has geometric multiplicity 1, otherwise the dimension of the eigenspace of A would be greater than 1. Let $\mathbf{w} = \begin{pmatrix} 0 \\ u_1 \\ u_2 \end{pmatrix}$, where $\begin{pmatrix} u_1 \\ u_2 \end{pmatrix}$ is an eigenvector of B .
- As \mathbf{w} and \mathbf{v}_1 are independent, we can expand $\{\mathbf{v}_1, \mathbf{w}\}$ to a basis $\{\mathbf{v}_1, \mathbf{w}, \mathbf{z}\}$ of \mathbb{C}^3 , and $A = \begin{pmatrix} \lambda & a & b \\ 0 & \lambda & c \\ 0 & 0 & d \end{pmatrix}$ with respect to this basis. Moreover, $a \neq 0$ since \mathbf{w} is not an eigenvector. Now let $\mathbf{v}_2 = \frac{1}{a}\mathbf{w}$. Then $A\mathbf{v}_2 = \frac{1}{a}A\mathbf{w} = \frac{1}{a}(a\mathbf{v}_1 + \lambda\mathbf{w}) = \mathbf{v}_1 + \lambda\mathbf{v}_2$, so that $(A - \lambda I)\mathbf{v}_2 = \mathbf{v}_1$ and $A = \begin{pmatrix} \lambda & 1 & b \\ 0 & \lambda & c \\ 0 & 0 & d \end{pmatrix}$ with respect to the basis $\{\mathbf{v}_1, \mathbf{v}_2, \mathbf{z}\}$.

(b) Let $\mathbf{w} = \begin{pmatrix} 0 \\ u'_1 \\ u'_2 \end{pmatrix}$, where $(B - \lambda I) \begin{pmatrix} u'_1 \\ u'_2 \end{pmatrix} = \begin{pmatrix} u_1 \\ u_2 \end{pmatrix}$. It is clear that $\{\mathbf{v}_1, \mathbf{v}_2, \mathbf{w}\}$ forms a basis for \mathbb{C}^3 , and $A = \begin{pmatrix} \lambda & 1 & b \\ 0 & \lambda & 1 \\ 0 & 0 & \lambda \end{pmatrix}$ with respect to this basis. Now let $\mathbf{v}_3 = \mathbf{w} - b\mathbf{v}_2$. Note that $\mathbf{v}_1, \mathbf{v}_2$, and \mathbf{v}_3 are linearly independent, and $A\mathbf{v}_3 = A\mathbf{w} - bA\mathbf{v}_2 = b\mathbf{v}_1 + \mathbf{v}_2 + \lambda\mathbf{w} - b(\mathbf{v}_1 + \lambda\mathbf{v}_2) = \mathbf{v}_2 + \lambda\mathbf{v}_3$. Hence $(A - \lambda I)\mathbf{v}_3 = \mathbf{v}_2$, and $A = \begin{pmatrix} \lambda & 1 & 0 \\ 0 & \lambda & 1 \\ 0 & 0 & \lambda \end{pmatrix}$ with respect to the basis $\{\mathbf{v}_1, \mathbf{v}_2, \mathbf{v}_3\}$ of \mathbb{C}^3 .

(c) Let $C = (\mathbf{v}_1, \mathbf{v}_2, \mathbf{v}_3)$, and $J = \begin{pmatrix} \lambda & 1 & 0 \\ 0 & \lambda & 1 \\ 0 & 0 & \lambda \end{pmatrix}$. Then $CJ = AC$, so that $J = C^{-1}AC$.

20. $\lambda = -1$ is an eigenvalue of A with geometric multiplicity 3. Solve $(A + I)\mathbf{v}_1 = 0$, $(A + I)\mathbf{v}_2 = \mathbf{v}_1$, and $(A + I)\mathbf{v}_3 = \mathbf{v}_2$ to find $\mathbf{v}_1 = \begin{pmatrix} 1 \\ 1 \\ 0 \end{pmatrix}$, $\mathbf{v}_2 = \begin{pmatrix} 0 \\ 1 \\ 1 \end{pmatrix}$ and $\mathbf{v}_3 = \begin{pmatrix} 1 \\ 1 \\ -1 \end{pmatrix}$. Hence $C = \begin{pmatrix} 1 & 0 & 1 \\ 1 & 1 & 1 \\ 0 & 1 & -1 \end{pmatrix}$ and

$$J = \begin{pmatrix} -1 & 1 & 0 \\ 0 & -1 & 1 \\ 0 & 0 & -1 \end{pmatrix}.$$

21. $\lambda = 0$ is an eigenvalue of A with algebraic multiplicity 3 and geometric multiplicity 1. Solve $A\mathbf{v}_1 = 0$, $A\mathbf{v}_2 = \mathbf{v}_1$, and $A\mathbf{v}_3 = \mathbf{v}_2$ to find $\mathbf{v}_1 = \begin{pmatrix} -1 \\ 0 \\ 1 \end{pmatrix}$, $\mathbf{v}_2 = \begin{pmatrix} 0 \\ 1 \\ -1 \end{pmatrix}$, and $\mathbf{v}_3 = \begin{pmatrix} -1 \\ 1 \\ -1 \end{pmatrix}$. Thus

$$C = \begin{pmatrix} -1 & 0 & -1 \\ 0 & 1 & 1 \\ 1 & -1 & -1 \end{pmatrix} \text{ and } J = \begin{pmatrix} 0 & 1 & 0 \\ 0 & 0 & 1 \\ 0 & 0 & 0 \end{pmatrix}.$$

22. $\lambda = -2$ is an eigenvalue of A with algebraic multiplicity 3 and geometric multiplicity 1. Solve

$(A + 2I)\mathbf{v}_1 = 0$, $(A + 2I)\mathbf{v}_2 = \mathbf{v}_1$, and $(A + 2I)\mathbf{v}_3 = \mathbf{v}_2$ to find $\mathbf{v}_1 = \begin{pmatrix} -5 \\ -3 \\ 7 \end{pmatrix}$, $\mathbf{v}_2 = \begin{pmatrix} -2 \\ -1 \\ 3 \end{pmatrix}$, and

$$\mathbf{v}_3 = \begin{pmatrix} 2 \\ 1 \\ -2 \end{pmatrix}. \text{ So } C = \begin{pmatrix} -5 & -2 & 2 \\ -3 & -1 & 1 \\ 7 & 3 & -2 \end{pmatrix} \text{ and } J = \begin{pmatrix} -2 & 1 & 0 \\ 0 & -2 & 1 \\ 0 & 0 & -2 \end{pmatrix}.$$

23. If $m = k$, then $A^m = 0$. If $m > k$, then $A^m = A^k \cdot A^{m-k} = 0 \cdot A^{m-k} = 0$.

24. We will show that $N_k^r = \left[\begin{matrix} \overbrace{\begin{pmatrix} 0 & 0 & \cdots & 0 \\ \vdots & \vdots & & \vdots \\ 0 & 0 & \cdots & 0 \\ \vdots & \vdots & & \vdots \\ 0 & 0 & \cdots & 0 \end{pmatrix}}^{r-1} \left[\begin{matrix} N_{k-r+1} \\ \cdots \\ 0 \\ \vdots \\ 0 \end{matrix} \right] \right]_{r-1}$ using induction on r . If $r = 1$, then the

result is true. Suppose the result is true for $r = \ell$. Let $N_k = (n_{ij})$ and $N_k^\ell = (a_{ij})$. Then $N_k^{\ell+1} = (b_{ij})$

where $b_{ij} = \sum_{s=1}^k n_{is} a_{sj}$. If $j \leq \ell + 1$ or $i \geq k - 1$, then $b_{ij} = 0$. If $j > \ell + 1$ and $i < k - 1$, then

$$b_{ij} = n_{i,i+1} a_{i+1,j} = a_{i+1,j} = \begin{cases} 1, & \text{if } (i,j) = (\alpha, \alpha + r + 1) \text{ where } \alpha = 1, 2, \dots, k - r - 1 \\ 0, & \text{otherwise} \end{cases} \text{ which means}$$

$$N_k^{\ell+1} = \left(\begin{array}{cccc|cccc} \hline 0 & 0 & \cdots & 0 & & & & \\ \vdots & \vdots & & \vdots & & & & \\ 0 & 0 & \cdots & 0 & \cdots & 0 & & \\ \vdots & \vdots & & \vdots & & & & \\ 0 & 0 & \cdots & 0 & \cdots & 0 & & \\ \hline & & & & N_{k-\ell} & & & \\ & & & & \cdots & & & \\ & & & & \vdots & & & \\ & & & & \cdots & & & \\ & & & & 0 & & & \\ \hline \end{array} \right)^\ell. \text{ Hence } N_k \text{ has index of nilpotency } k.$$

$$25. \begin{pmatrix} a & 0 & 0 & 0 \\ 0 & b & 0 & 0 \\ 0 & 0 & c & 0 \\ 0 & 0 & 0 & d \end{pmatrix}; \begin{pmatrix} a & 0 & 0 & 0 \\ 0 & b & 0 & 0 \\ 0 & 0 & c & 1 \\ 0 & 0 & 0 & c \end{pmatrix}; \begin{pmatrix} a & 0 & 0 & 0 \\ 0 & b & 1 & 0 \\ 0 & 0 & b & 1 \\ 0 & 0 & 0 & b \end{pmatrix}; \begin{pmatrix} a & 1 & 0 & 0 \\ 0 & a & 1 & 0 \\ 0 & 0 & a & 1 \\ 0 & 0 & 0 & a \end{pmatrix}; \begin{pmatrix} a & 1 & 0 & 0 \\ 0 & a & 0 & 0 \\ 0 & 0 & b & 1 \\ 0 & 0 & 0 & b \end{pmatrix};$$

a, b, c , and d are not necessarily distinct, and the blocks may be permuted along the diagonal.

$$26. \begin{pmatrix} -1 & 0 & 0 & 0 \\ 0 & -1 & 0 & 0 \\ 0 & 0 & 2 & 0 \\ 0 & 0 & 0 & 2 \end{pmatrix}; \begin{pmatrix} -1 & 1 & 0 & 0 \\ 0 & -1 & 0 & 0 \\ 0 & 0 & 2 & 0 \\ 0 & 0 & 0 & 2 \end{pmatrix}; \begin{pmatrix} -1 & 0 & 0 & 0 \\ 0 & -1 & 0 & 0 \\ 0 & 0 & 2 & 1 \\ 0 & 0 & 0 & 2 \end{pmatrix}; \begin{pmatrix} -1 & 1 & 0 & 0 \\ 0 & -1 & 0 & 0 \\ 0 & 0 & 2 & 1 \\ 0 & 0 & 0 & 2 \end{pmatrix}; \text{ the blocks may be permuted along the diagonal.}$$

$$27. \begin{pmatrix} -4 & 0 & 0 & 0 \\ 0 & 3 & 0 & 0 \\ 0 & 0 & 3 & 0 \\ 0 & 0 & 0 & 3 \end{pmatrix}; \begin{pmatrix} -4 & 0 & 0 & 0 \\ 0 & 3 & 0 & 0 \\ 0 & 0 & 3 & 1 \\ 0 & 0 & 0 & 3 \end{pmatrix}; \begin{pmatrix} -4 & 0 & 0 & 0 \\ 0 & 3 & 1 & 0 \\ 0 & 0 & 3 & 1 \\ 0 & 0 & 0 & 3 \end{pmatrix}; \text{ the blocks may be permuted along the diagonal.}$$

$$28. \begin{pmatrix} 3 & 0 & 0 & 0 \\ 0 & 3 & 0 & 0 \\ 0 & 0 & 3 & 0 \\ 0 & 0 & 0 & 3 \end{pmatrix}; \begin{pmatrix} 3 & 0 & 0 & 0 \\ 0 & 3 & 0 & 0 \\ 0 & 0 & 3 & 1 \\ 0 & 0 & 0 & 3 \end{pmatrix}; \begin{pmatrix} 3 & 0 & 0 & 0 \\ 0 & 3 & 1 & 0 \\ 0 & 0 & 3 & 1 \\ 0 & 0 & 0 & 3 \end{pmatrix}; \begin{pmatrix} 3 & 1 & 0 & 0 \\ 0 & 3 & 1 & 0 \\ 0 & 0 & 3 & 1 \\ 0 & 0 & 0 & 3 \end{pmatrix}; \text{ the blocks may be permuted along the diagonal.}$$

$$29. \begin{pmatrix} -3 & 0 & 0 & 0 & 0 \\ 0 & -3 & 0 & 0 & 0 \\ 0 & 0 & 4 & 0 & 0 \\ 0 & 0 & 0 & 4 & 0 \\ 0 & 0 & 0 & 0 & 4 \end{pmatrix}; \begin{pmatrix} -3 & 1 & 0 & 0 & 0 \\ 0 & -3 & 0 & 0 & 0 \\ 0 & 0 & 4 & 0 & 0 \\ 0 & 0 & 0 & 4 & 0 \\ 0 & 0 & 0 & 0 & 4 \end{pmatrix}; \begin{pmatrix} -3 & 1 & 0 & 0 & 0 \\ 0 & -3 & 0 & 0 & 0 \\ 0 & 0 & 4 & 0 & 0 \\ 0 & 0 & 0 & 4 & 1 \\ 0 & 0 & 0 & 0 & 4 \end{pmatrix}; \begin{pmatrix} -3 & 1 & 0 & 0 & 0 \\ 0 & -3 & 0 & 0 & 0 \\ 0 & 0 & 4 & 1 & 0 \\ 0 & 0 & 0 & 4 & 1 \\ 0 & 0 & 0 & 0 & 4 \end{pmatrix}; \begin{pmatrix} -3 & 0 & 0 & 0 & 0 \\ 0 & -3 & 0 & 0 & 0 \\ 0 & 0 & 4 & 0 & 0 \\ 0 & 0 & 0 & 4 & 1 \\ 0 & 0 & 0 & 0 & 4 \end{pmatrix}; \begin{pmatrix} -3 & 0 & 0 & 0 & 0 \\ 0 & -3 & 0 & 0 & 0 \\ 0 & 0 & 4 & 1 & 0 \\ 0 & 0 & 0 & 4 & 1 \\ 0 & 0 & 0 & 0 & 4 \end{pmatrix}; \text{ the blocks may be permuted along the diagonal.}$$

$$30. \begin{pmatrix} 6 & 0 & 0 & 0 & 0 \\ 0 & -7 & 0 & 0 & 0 \\ 0 & 0 & -7 & 0 & 0 \\ 0 & 0 & 0 & -7 & 0 \\ 0 & 0 & 0 & 0 & -7 \end{pmatrix}; \begin{pmatrix} 6 & 0 & 0 & 0 & 0 \\ 0 & -7 & 0 & 0 & 0 \\ 0 & 0 & -7 & 0 & 0 \\ 0 & 0 & 0 & -7 & 1 \\ 0 & 0 & 0 & 0 & -7 \end{pmatrix}; \begin{pmatrix} 6 & 0 & 0 & 0 & 0 \\ 0 & -7 & 0 & 0 & 0 \\ 0 & 0 & -7 & 1 & 0 \\ 0 & 0 & 0 & -7 & 1 \\ 0 & 0 & 0 & 0 & -7 \end{pmatrix}; \begin{pmatrix} 6 & 0 & 0 & 0 & 0 \\ 0 & -7 & 1 & 0 & 0 \\ 0 & 0 & -7 & 1 & 0 \\ 0 & 0 & 0 & -7 & 1 \\ 0 & 0 & 0 & 0 & -7 \end{pmatrix}; \text{ the blocks may be permuted along the diagonal.}$$

$$\begin{aligned}
 31. & \begin{pmatrix} -7 & 0 & 0 & 0 & 0 \\ 0 & -7 & 0 & 0 & 0 \\ 0 & 0 & -7 & 0 & 0 \\ 0 & 0 & 0 & -7 & 0 \\ 0 & 0 & 0 & 0 & -7 \end{pmatrix}; \begin{pmatrix} -7 & 0 & 0 & 0 & 0 \\ 0 & -7 & 0 & 0 & 0 \\ 0 & 0 & -7 & 0 & 0 \\ 0 & 0 & 0 & -7 & 1 \\ 0 & 0 & 0 & 0 & -7 \end{pmatrix}; \begin{pmatrix} -7 & 0 & 0 & 0 & 0 \\ 0 & -7 & 0 & 0 & 0 \\ 0 & 0 & -7 & 0 & 1 \\ 0 & 0 & 0 & -7 & 1 \\ 0 & 0 & 0 & 0 & -7 \end{pmatrix}; \\
 & \begin{pmatrix} -7 & 0 & 0 & 0 & 0 \\ 0 & -7 & 1 & 0 & 0 \\ 0 & 0 & -7 & 1 & 0 \\ 0 & 0 & 0 & -7 & 1 \\ 0 & 0 & 0 & 0 & -7 \end{pmatrix}; \begin{pmatrix} -7 & 1 & 0 & 0 & 0 \\ 0 & -7 & 1 & 0 & 0 \\ 0 & 0 & -7 & 1 & 0 \\ 0 & 0 & 0 & -7 & 1 \\ 0 & 0 & 0 & 0 & -7 \end{pmatrix}; \text{ the blocks may be permuted along the diagonal.}
 \end{aligned}$$

$$32. \text{ As } C^{-1}AC = J, \text{ then } \det(C^{-1}AC) = \det(C)^{-1} \det(A) \det(C) = \det(A) = \det(J) = \lambda_1 \lambda_2 \cdots \lambda_n.$$

MATLAB 6.6

1. (a) Let

```

>> J=diag([2 2 3 3]); % First enter the diagonal entries of J
>> J(3,4)=1          % Next enter the one off diagonal 1
J =
     2     0     0     0
     0     2     0     0
     0     0     3     1
     0     0     0     3
>> c1=[1 1 2 1]'; c2=[2 3 4 3]'; c3=[2 5 3 3]'; c4=[-1 3 0 6]';
>> C=[c1 c2 c3 c4] ; A = C*J/C
A =
-14.0000    5.0000    8.0000   -5.0000
-62.0000   20.0000   31.0000  -18.0000
-30.0000    9.0000   17.0000   -9.0000
-54.0000   15.0000   27.0000  -13.0000

```

(i) We show the columns c_1 and c_2 are eigenvectors for A for the eigenvalue $\lambda = 2$, by showing $(A - 2I)c_i = 0$:

```

>> (A-2*eye(4))*c1 % If (essentially) 0 then c1 is eigenvector for A
ans =
 1.0e-14 *
-0.1776
 0.3553
 0
-0.3553

>> (A-2*eye(4))*c2
ans =
 1.0e-14 *
-0.5329
 0
-0.3553
 0

>> % Preceding is (essentially) 0, so c2 an eigenvector for A

```

(ii) Now we investigate the eigenvector properties of c_3 and c_4 .

```

>> (A-3*eye(4))*c3 % (Essentially) 0 so c3 is an eigenvector for A
ans =
 1.0e-13 *
-0.0178
 0
 0.0355
 0.1421

>> (A-3*eye(4))*c4 % Not 0 (not close) so c4 is NOT an eigenvector for A
ans =
 2.0000
 5.0000
 3.0000
 3.0000

>> % Note (A-3I)c4 = c3, which is an eigenvector, i.e.

```

```

>> (A-3*eye(4))*((A-3*eye(4))*c4)
ans =
    1.0e-12 *
    -0.1865
    -0.6821
    -0.3304
    -0.5969
>> % (Essentially) 0 so c4 is a generalized eigenvector for A

```

(iii) Repeat the calculations with any other choice of an invertible C .

(iv) To see that $A = CJC^{-1}$ has $\lambda = 2$ as an eigenvalue of algebraic and geometric multiplicity 2 and $\mu = 3$ as an eigenvalue of algebraic multiplicity 2 and geometric multiplicity 3 (for any invertible C) first note that since A and J are similar, they have the same characteristic polynomials (Theorem 6.3.1). But $\det(J - tI) = (2 - t)^2(3 - t)^2$ as $J - tI$ is upper triangular, so both 2 and 3 are eigenvalues with algebraic multiplicity 2.

As to geometric multiplicity, it is immediate that if $E(\lambda)$ is an eigenspace for J , then $CE(\lambda)$ is the corresponding eigenspace for $A = CJC^{-1}$, and both have the same dimension since C is invertible. But $J - 2I$ is already in echelon form from which we see that $\nu(J - 2I) = 2$ since x_1, x_2 will be free variables in any solution to $(J - 2I)x = 0$. Thus the geometric multiplicity of 2 as an eigenvalue for A is 2. For the eigenvalue 3, $J - 3I$ is also in echelon form, but with 3 non-zero rows, so $\nu(J - 3I) = 4 - 3 = 1$. Thus the geometric multiplicity of 3 as an eigenvalue for A is 1.

(b) Form a new J and a new A :

```

>> J = diag([3 3 3 3]); J(1,2)=1 ; J(2,3)=1
>> A = C*J/C
A =
    24.0000    -5.0000   -11.0000     6.0000
    15.0000     0.0000    -8.0000     4.0000
    42.0000   -10.0000   -19.0000    12.0000
    15.0000    -3.0000    -8.0000     7.0000

```

(i)

```

>> (A-3*eye(4))*C(:,4) % Get the easy case over: c4 is eigenvector for A
ans =
     0
     0
     0
     0
>> for j=1:3, (A-3*eye(4))^j*C(:,j) , end
ans =
    1.0e-14 *
         0
     0.0888
    -0.1776
         0
ans =
    1.0e-12 *
    -0.0853
     0.1137
    -0.0853
    -0.0426

```

```
ans =
    1.0e-11 *
    -0.0917
    -0.0568
    -0.1819
    -0.0568
>> % Each was (essentially) zero, so c1,c2,c3 are generalized eigenvectors
```

This shows that c_1 and c_4 are actually eigenvectors for A . To verify that c_2 and c_3 are only generalized eigenvectors we must check that $(A - 3I)c_2 \neq 0$ and $(A - 3I)^2 c_3 \neq 0$.

```
>> (A-3*eye(4))*c2      % Not zero so c2 only a generalized eigenvector for A
ans =
    1.0000
    1.0000
    2.0000
    1.0000
>> % Note (A-3I)c2 = c1

>> (A-3*eye(4))^2*c3    % Not zero so c3 only a generalized eigenvector for A
ans =
    1.0000
    1.0000
    2.0000
    1.0000
>> % Note (A-3I)^2 c3 = c1
```

- (ii) Repeat the above with another invertible C of the same size. The pattern of zero and non-zero products and the conclusions about which columns of C are eigenvectors or generalized eigenvectors should be the same as in (i).
- (iii) As in (a)(iv), $\det(A - tI) = \det(J - tI) = (3 - t)^4$ so 3 is an eigenvalue of algebraic multiplicity 4. Also, $J - 3I$ is in echelon form, and shows there are 2 free variables in solutions to $(J - 3I)z = 0$. Applying C to the null space of $J - 3I$ yields the null space of $A - 3I$; in particular, a basis of two independent solutions to $(J - 3I)z_i = 0$ becomes $x_i = Cz_i$, a basis of two independent solutions to $0 = (A - 3I)x = C(J - 3I)C^{-1}(Cx)$. Thus the geometric multiplicity of the eigenvalue 3 is 2.

(c) Form a new J and A with

```
>> J=diag([2 2 3 3]); J(1,2)=1 ; J(3,4)=1 ;

>> A=C*J/C
A =
    19.0000   -4.0000   -9.0000    5.0000
   -29.0000   11.0000   14.0000   -8.0000
    36.0000   -9.0000  -17.0000   11.0000
   -21.0000    6.0000   10.0000   -3.0000
```

- (i) We expect columns c_1 , c_3 to be eigenvectors and c_2 , c_4 to be generalized eigenvectors.

```
>> for j=1:4, (A-J(j,j)*eye(4))*C(:,j) , end
ans =
    1.0e-14 *
    -0.0888
     0.1776
    -0.1776
     0
```

```

ans =
    1.0000
    1.0000
    2.0000
    1.0000

ans =
    1.0e-13 *
   -0.0711
         0
   -0.1421
         0

ans =
    2.0000
    5.0000
    3.0000
    3.0000

```

Since $(A-2I)c_1 = 0$ and $(A-3I)c_3 = 0$, c_1 , c_3 are eigenvectors for A for the eigenvalues 2,3 respectively. Also, note that the second product above says $(A-2I)c_2 = c_1 (\neq 0)$, so c_2 is not an eigenvector for A but is a generalized eigenvector for A (as $(A-2I)^2 c_2 = (A-2I)c_1 = 0$). Similarly, the fourth product above says $(A-3I)c_4 = c_3$ and shows c_4 is a generalized eigenvector for A .

- (ii) A repetition with different invertible C will yield exactly the same patterns of eigenvectors and generalized eigenvectors.
- (iii) The algebraic multiplicities of 2 and 3 are both 2, since $\det(A-tI) = \det(J-tI) = (2-t)^2(3-t)^2$ has $(t-2)$ and $(t-3)$ as factors of order 2. However, $J-2I$ has 3 pivots, after moving the second row to the bottom, so $\nu(J-2I) = 4-3 = 1$, and thus the geometric multiplicity for the eigenvalue 2 for A is 1. (As usual the eigenspace for J maps under C to the eigenspace for A .) Similarly $J-3I$ has 3 pivots and the same reasoning shows the geometric multiplicity for the eigenvalue 3 of A is 1.

2. First we form an invertible 5×5 matrix, C :

```

>> C = round(10*rand(5)-3*ones(5,5))
C =
   -1    1    2    1    2
   -3    2    4    4   -2
    4    5   -3    3    4
    4   -3    1    6    1
    6   -2   -2    5    4

>> det(C)    % If non-zero then invertible
ans =
   -673

>> % To make c1,c2 (generalized) eigenvectors associated with 2
>> %   and c3,c4,c5 (generalized) eigenvectors associated with 4
>> % Form the following Jordan matrix
>> J = diag([2 2 4 4 4]); J(1,2)=1 ; J(3,4)=1 ; J(4,5)=1
J =
    2    1    0    0    0
    0    2    0    0    0
    0    0    4    1    0
    0    0    0    4    1
    0    0    0    0    4

```

Since this J has e_1, e_2 as (generalized) eigenvectors associated with 2 and e_3, e_4, e_5 as (generalized) eigenvectors associated with 4, then the similar matrix, $A = CJC^{-1}$ will have $Ce_1 = c_1, Ce_2 = c_2$ as (generalized) eigenvectors associated with 2 (and also the last 3 columns of C will be (generalized) eigenvectors for A associated with 4). Also, for J , hence for A , the algebraic multiplicity of 2 will be 2 and the algebraic multiplicity of 4 will be 3. (Look: $\det(A-tI) = \det(C(J-tI)C^{-1}) = \det(J-tI) = (2-t)^2(4-t)^3$) Also the geometric multiplicity of 2 and of 4 will be 1, for both J and A , since multiplication by C will take the null space of J isomorphically onto the null space of A . The following calculates A and verifies these facts:

```
>> A = C*J/C
A =
    4.0134    0.0698   -0.4086   -0.1055    0.7132
    0.8276    3.2110   -0.5111    0.9153    0.4740
   -0.6686    4.5082   -0.5691   -9.7251   10.3388
    0.1040    4.3210   -1.6226   -3.9316    7.2140
   -0.2823    5.4146   -2.5958  -10.3284   13.2764

>> (A-2*eye(5))*C(:,1) %(Essentially) zero so c1 is an eigenvector, eigenvalue 2.
ans =
    1.0e-13 *
         0
         0
   -0.1421
         0
         0

>> (A-2*eye(5))*C(:,2) %This gives C(:,1), so c2 is a generalized eigenvector.
ans =
   -1.0000
   -3.0000
    4.0000
    4.0000
    6.0000

>> (A-4*eye(5))*C(:,3) %(Essentially) zero so c3 is an eigenvector, eigenvalue 4.
ans =
    1.0e-14 *
   -0.0444
    0.0222
    0.3553
   -0.3553
         0

>> (A-4*eye(5))*C(:,4) %This gives C(:,3), so c4 is a generalized eigenvector.
ans =
    2.0000
    4.0000
   -3.0000
    1.0000
   -2.0000

>> (A-4*eye(5))^2*C(:,5) %Also gives C(:,3), so c5 is a generalized eigenvector.
ans =
    2.0000
    4.0000
   -3.0000
    1.0000
   -2.0000
```

Section 6.7

- $$\begin{vmatrix} -2-\lambda & -2 \\ -5 & 1-\lambda \end{vmatrix} = \lambda^2 + \lambda - 12; \lambda = -4, 3. C = \begin{pmatrix} 1 & 2 \\ 1 & -5 \end{pmatrix}; C^{-1} = \frac{-1}{7} \begin{pmatrix} -5 & -2 \\ -1 & 1 \end{pmatrix}; J = \begin{pmatrix} -4 & 0 \\ 0 & 3 \end{pmatrix}.$$

$$e^{At} = Ce^{Jt}C^{-1} = \frac{1}{7} \begin{pmatrix} 5e^{-4t} + 2e^{3t} & 2e^{-4t} - 2e^{3t} \\ 5e^{-4t} - 5e^{3t} & 2e^{-4t} + 5e^{3t} \end{pmatrix}.$$
- $$\begin{vmatrix} 3-\lambda & -1 \\ -2 & 4-\lambda \end{vmatrix} = \lambda^2 - 7\lambda + 10; \lambda = 2, 5. C = \begin{pmatrix} 1 & -1 \\ 1 & 2 \end{pmatrix}; C^{-1} = \frac{1}{3} \begin{pmatrix} 2 & 1 \\ -1 & 1 \end{pmatrix}; J = \begin{pmatrix} 2 & 0 \\ 0 & 5 \end{pmatrix}.$$

$$e^{At} = Ce^{Jt}C^{-1} = \frac{1}{3} \begin{pmatrix} 2e^{2t} - e^{5t} & -2e^{2t} - 2e^{5t} \\ 2e^{2t} + 2e^{5t} & -e^{2t} + 4e^{5t} \end{pmatrix}.$$
- $$\begin{vmatrix} 2-\lambda & -1 \\ 5 & -2-\lambda \end{vmatrix} = \lambda^2 + 1; \lambda = i, -i. C = \begin{pmatrix} 2+i & 2-i \\ 5 & 5 \end{pmatrix}; C^{-1} = \frac{1}{10i} \begin{pmatrix} 5 & -2+i \\ -5 & 2+i \end{pmatrix};$$

$$J = \begin{pmatrix} i & 0 \\ 0 & -i \end{pmatrix}. e^{At} = Ce^{Jt}C^{-1} = \begin{pmatrix} 2\sin t + \cos t & -\sin t \\ 5\sin t & -2\sin t + \cos t \end{pmatrix}.$$
- $$\begin{vmatrix} 3-\lambda & -5 \\ 1 & -1-\lambda \end{vmatrix} = \lambda^2 - 2\lambda + 2; \lambda = 1 \pm i. C = \begin{pmatrix} 5 & 5 \\ 2-i & 2+i \end{pmatrix}; C^{-1} = \frac{1}{10i} \begin{pmatrix} 2+i & -5 \\ -2+i & 5 \end{pmatrix}; J =$$

$$\begin{pmatrix} 1+i & 0 \\ 0 & 1-i \end{pmatrix}. e^{At} = Ce^{Jt}C^{-1} = e^t \begin{pmatrix} 2\sin t + \cos t & -5\sin t \\ \sin t & -2\sin t + \cos t \end{pmatrix}.$$
- $$\begin{vmatrix} -10-\lambda & -7 \\ 7 & 4-\lambda \end{vmatrix} = \lambda^2 + 6\lambda + 9; \lambda = -3, -3. C = \begin{pmatrix} 1 & 0 \\ -1 & -1/7 \end{pmatrix}; C^{-1} = \begin{pmatrix} 1 & 0 \\ -7 & -7 \end{pmatrix};$$

$$J = \begin{pmatrix} -3 & 1 \\ 0 & -3 \end{pmatrix}. e^{At} = Ce^{Jt}C^{-1} = e^{-3t} \begin{pmatrix} 1-7t & -7t \\ 7t & 7t+1 \end{pmatrix}.$$
- $$\begin{vmatrix} -2-\lambda & 1 \\ 5 & 2-\lambda \end{vmatrix} = \lambda^2 + 1; \lambda = i, -i. C = \begin{pmatrix} -1 & -1 \\ 2+i & 2-i \end{pmatrix}; C^{-1} = \frac{1}{2i} \begin{pmatrix} 2-i & 1 \\ -2-i & -1 \end{pmatrix}; J = \begin{pmatrix} i & 0 \\ 0 & -i \end{pmatrix}.$$

$$e^{At} = Ce^{Jt}C^{-1} = \begin{pmatrix} \cos 5 - 2\sin t & -\sin t \\ 5\sin t & \cos t + 2\sin t \end{pmatrix}.$$
- $$\begin{vmatrix} -12-\lambda & 7 \\ -7 & 2-\lambda \end{vmatrix} = \lambda^2 + 10\lambda + 25; \lambda = -5, -5. C = \begin{pmatrix} 1 & 0 \\ 1 & 1/7 \end{pmatrix}; C^{-1} = \begin{pmatrix} 1 & 0 \\ -7 & 7 \end{pmatrix}; J = \begin{pmatrix} -5 & 1 \\ 0 & -5 \end{pmatrix}.$$

$$e^{At} = Ce^{Jt}C^{-1} = e^{-5t} \begin{pmatrix} 1-7t & 7t \\ -7t & 7t+1 \end{pmatrix}.$$
- $$\begin{vmatrix} 1-\lambda & 1 & -2 \\ -1 & 2-\lambda & 1 \\ 0 & 1 & -1-\lambda \end{vmatrix} = -2 + \lambda + 2\lambda^2 - \lambda^3; \lambda = -1, 1, 2. C = \begin{pmatrix} 1 & 3 & 1 \\ 0 & 2 & 3 \\ 1 & 1 & 1 \end{pmatrix}; C^{-1} = \frac{1}{6} \begin{pmatrix} -1 & -2 & 7 \\ 3 & 0 & -3 \\ -2 & 2 & 2 \end{pmatrix};$$

$$J = \begin{pmatrix} -1 & 0 & 0 \\ 0 & 1 & 0 \\ 0 & 0 & 2 \end{pmatrix}. e^{At} = Ce^{Jt}C^{-1} = \frac{1}{6} \begin{pmatrix} -e^{-t} + 9e^t - 2e^{2t} & -2e^{-t} + 2e^{2t} & -7e^{-t} - 9e^t + 2e^{2t} \\ 6e^t - 6e^{2t} & 6e^{2t} & -6e^t + 6e^{2t} \\ -e^{-t} + 3e^t - 2e^{2t} & -2e^{-t} + 2e^{2t} & -7e^{-t} - 3e^t + 2e^{2t} \end{pmatrix}$$
- $$\begin{vmatrix} 4-\lambda & 6 & 6 \\ 1 & 3-\lambda & 2 \\ -1 & -5 & -2-\lambda \end{vmatrix} = 4 - 8\lambda + 5\lambda^2 - \lambda^3; \lambda = 1, 2, 2. C = \begin{pmatrix} 4 & 3 & 0 \\ 1 & 1 & 0 \\ -3 & -2 & 1/2 \end{pmatrix};$$

$$C^{-1} = \begin{pmatrix} 1 & -3 & 0 \\ -1 & 4 & 0 \\ 2 & -2 & 2 \end{pmatrix}; J = \begin{pmatrix} 1 & 0 & 0 \\ 0 & 2 & 1 \\ 0 & 0 & 2 \end{pmatrix}.$$

$$e^{At} = Ce^{Jt}C^{-1} = \begin{pmatrix} 4e^t - 3e^{2t} + 6te^{2t} & -12e^t + 12e^{2t} - 6te^{2t} & 6te^{2t} \\ e^t - e^{2t} + 2te^{2t} & -3e^t + 4e^{2t} - 2te^{2t} & 2te^{2t} \\ -3e^t + 3e^{2t} - 4te^{2t} & 9e^t - 9e^{2t} + 4te^{2t} & -4te^{2t} + e^{2t} \end{pmatrix}$$

10. $\mathbf{x}(t) = e^{At}\mathbf{x}_0 = \frac{-1}{3} \begin{pmatrix} -e^t - 2e^{4t} & -e^t + e^{4t} \\ -2e^t + 2e^{4t} & -2e^t - e^{4t} \end{pmatrix} \begin{pmatrix} a \\ 2a \end{pmatrix} = e^t \begin{pmatrix} a \\ 4a/3 \end{pmatrix}$. Then both populations grow at a rate proportional to e^t .

11. Let $\mathbf{x}_0 = \begin{pmatrix} a \\ b \end{pmatrix}$, where $b > 2a$. Then $\mathbf{x}(t) = \begin{pmatrix} (a+b)e^t/3 + (2a-b)e^{4t}/3 \\ 2(a+b)e^t/3 + (b-2a)e^{4t}/3 \end{pmatrix}$. Note that since $b > 2a$, $2a - b < 0$. Then there exists $t > 0$ such that $(a+b)e^t/3 + (2a-b)e^{4t}/3 \leq 0$. That is, the first population will be eliminated.

12. $\mathbf{x}(t) = e^{3t} \begin{pmatrix} 1-t & -t \\ t & 1+t \end{pmatrix} \begin{pmatrix} x_1(0) \\ x_2(0) \end{pmatrix} = e^{3t} \begin{pmatrix} x_1(0) - t(x_1(0) + x_2(0)) \\ x_2(0) + t(x_1(0) + x_2(0)) \end{pmatrix}$. $x_1(0) - t(x_1(0) + x_2(0)) = 0 \Rightarrow t = x_1(0)/(x_1(0) + x_2(0))$.

13. Let $x_1(t) =$ kg. of salt in tank 1 and $x_2(t) =$ kg. of salt in tank 2. Then $\begin{pmatrix} x_1 \\ x_2 \end{pmatrix}' = \frac{1}{1000} \begin{pmatrix} -30 & 10 \\ 30 & -30 \end{pmatrix}$;

$$\mathbf{x}_0 = \begin{pmatrix} 1000 \\ 0 \end{pmatrix}; \begin{vmatrix} -0.03 - \lambda & 0.01 \\ 0.03 & -0.03 - \lambda \end{vmatrix} = \lambda^2 + 0.06\lambda + 0.0006; \lambda = -0.03 \pm \sqrt{0.0003}. \text{ Let } \alpha = -0.03 + \sqrt{0.0003} \text{ and } \beta = -0.03 - \sqrt{0.0003}. C = \begin{pmatrix} \sqrt{0.0003} & -\sqrt{0.0003} \\ 0.03 & -0.03 \end{pmatrix}; C^{-1} = \frac{1}{0.06\sqrt{0.0003}} \begin{pmatrix} 0.03 & \sqrt{0.0003} \\ -0.03 & \sqrt{0.0003} \end{pmatrix};$$

$$J = \begin{pmatrix} \alpha & 0 \\ 0 & \beta \end{pmatrix}. e^{At} = Ce^{Jt}C^{-1} = \begin{pmatrix} (e^\alpha + e^\beta)/2 - \sqrt{0.0003}(e^\alpha - e^\beta)/2 & \sqrt{0.0003}(e^\alpha - e^\beta)/2 \\ 0.015(e^\alpha - e^\beta)/\sqrt{0.0003} & (-e^\alpha + e^\beta)/2 \end{pmatrix}.$$

$$e^{At}\mathbf{x}(0) = \begin{pmatrix} 500(e^\alpha + e^\beta) \\ -500\sqrt{0.0003}(e^\alpha + e^\beta) \end{pmatrix}.$$

14. Note that if $A = \begin{pmatrix} 0 & a & 0 \\ 0 & b & 0 \\ 0 & c & 0 \end{pmatrix}$ then $e^{At} = \begin{pmatrix} 1 & (ae^{bt} - a)/b & 0 \\ 0 & e^{bt} & 0 \\ 0 & (ce^{bt} - c)/b & 1 \end{pmatrix}$.

$$(a) \begin{pmatrix} x_1'(t) \\ x_2'(t) \\ x_3'(t) \end{pmatrix} = \begin{pmatrix} 0 & -\alpha x_1(0) & 0 \\ 0 & \alpha x_1(0) - \beta & 0 \\ 0 & & \beta \end{pmatrix} \begin{pmatrix} x_1(t) \\ x_2(t) \\ x_3(t) \end{pmatrix}$$

$$\mathbf{x} = e^{At}\mathbf{x}(0) = \begin{pmatrix} 1 & (-\alpha x_1(0)e^{(\alpha x_1(0) - \beta)t} + \alpha x_1(0))/(\alpha x_1(0) - \beta) & 0 \\ 0 & e^{(\alpha x_1(0) - \beta)t} & 0 \\ 0 & (\beta e^{(\alpha x_1(0) - \beta)t} - \beta)/(\alpha x_1(0) - \beta) & 1 \end{pmatrix} \begin{pmatrix} x_1(0) \\ x_2(0) \\ x_3(0) \end{pmatrix}$$

$$= \begin{pmatrix} x_1(0) + x_2(0)(-\alpha x_1(0)e^{(\alpha x_1(0) - \beta)t} + \alpha x_1(0))/(\alpha x_1(0) - \beta) \\ x_2(0)e^{(\alpha x_1(0) - \beta)t} \\ x_3(0) + x_2(0)(\beta e^{(\alpha x_1(0) - \beta)t} - \beta)/(\alpha x_1(0) - \beta) \end{pmatrix}.$$

(a) If $\alpha x_1(0) < \beta$ then $x_2'(t) < 0$ which implies that no epidemic can build up.

(c) If $\alpha x_1(0) > \beta$ then $x_2'(t) > 0$ and an epidemic will occur.

15. (a) $x_1'(t) = x'(t) = x_2(t)$.

$$x_2(t) = x''(t) = -ax'(t) - bx(t) = -ax_2(t) - bx_1(t).$$

$$\begin{pmatrix} x_1'(t) \\ x_2'(t) \end{pmatrix} = \begin{pmatrix} 0 & 1 \\ -b & -a \end{pmatrix} \begin{pmatrix} x_1(t) \\ x_2(t) \end{pmatrix}$$

$$(b) \begin{vmatrix} -\lambda & 1 \\ -b & -a - \lambda \end{vmatrix} = \lambda^2 + a\lambda + b = 0.$$

16. $\lambda^2 + 5\lambda + 6 = 0 \Rightarrow \lambda = -2, -3$. $C = \begin{pmatrix} 1 & -1 \\ -2 & 3 \end{pmatrix}$; $C^{-1} = \begin{pmatrix} 3 & 1 \\ 2 & 1 \end{pmatrix}$; $J = \begin{pmatrix} -2 & 0 \\ 0 & -3 \end{pmatrix}$;

$$e^{At} = Ce^{Jt}C^{-1} = \begin{pmatrix} 3e^{-2t} - 2e^{-3t} & e^{-2t} - e^{-3t} \\ -6e^{-2t} + 6e^{-3t} & -2e^{-2t} + 3e^{-3t} \end{pmatrix}. \begin{pmatrix} x_1(t) \\ x_2(t) \end{pmatrix} = e^{At} \begin{pmatrix} 1 \\ 0 \end{pmatrix} = \begin{pmatrix} 3e^{-2t} - 2e^{-3t} \\ -6e^{-2t} + 6e^{-3t} \end{pmatrix}.$$

Then $x = 3e^{-2t} - 2e^{-3t}$.

17. $\lambda^2 + 6\lambda + 9 = 0 \Rightarrow \lambda = -3, -3$. $C = \begin{pmatrix} 1 & 0 \\ -3 & 1 \end{pmatrix}$; $C^{-1} = \begin{pmatrix} 1 & 0 \\ 3 & 1 \end{pmatrix}$; $J = \begin{pmatrix} -3 & 1 \\ 0 & -3 \end{pmatrix}$; $e^{At} = Ce^{Jt}C^{-1} = e^{-3t} \begin{pmatrix} 1+3t & t \\ -9t & 1-3t \end{pmatrix} \cdot \begin{pmatrix} x_1(t) \\ x_2(t) \end{pmatrix} = e^{At} \begin{pmatrix} 1 \\ 2 \end{pmatrix} = e^{-3t} \begin{pmatrix} 1+5t \\ 2-18t \end{pmatrix}$. Then $x = e^{-3t}(1+5t)$.

18. $\lambda^2 + 4 = 0 \Rightarrow \lambda = \pm 2i$. $C = \begin{pmatrix} 2i & -2i \\ -4 & -4 \end{pmatrix}$; $C^{-1} = \frac{-1}{16i} \begin{pmatrix} -4 & 2i \\ 4 & 2i \end{pmatrix}$; $J = \begin{pmatrix} 2i & 0 \\ 0 & -2i \end{pmatrix}$; $e^{At} = Ce^{Jt}C^{-1} = \begin{pmatrix} \cos 2t & (\sin 2t)/2 \\ -2 \sin 2t & \cos 2t \end{pmatrix} \cdot \begin{pmatrix} x_1(t) \\ x_2(t) \end{pmatrix} = e^{At} \begin{pmatrix} 0 \\ 1 \end{pmatrix} = \begin{pmatrix} (\sin 2t)/2 \\ \cos 2t \end{pmatrix}$. Then $x = (\sin 2t)/2$.

19. $\lambda^2 - 3\lambda - 10 = 0 \Rightarrow \lambda = -2, 5$. $C = \begin{pmatrix} 1 & 5 \\ -2 & 5 \end{pmatrix}$; $C^{-1} = \frac{1}{7} \begin{pmatrix} 5 & -1 \\ 2 & 1 \end{pmatrix}$; $J = \begin{pmatrix} -2 & 0 \\ 0 & 5 \end{pmatrix}$; $e^{At} = Ce^{Jt}C^{-1} = \frac{1}{7} \begin{pmatrix} 5e^{-2t} + 2e^{5t} & -e^{-2t} + e^{5t} \\ -10e^{-2t} + 10e^{5t} & 2e^{-2t} + 5e^{5t} \end{pmatrix} \cdot \begin{pmatrix} x_1(t) \\ x_2(t) \end{pmatrix} = e^{At} \begin{pmatrix} 3 \\ 2 \end{pmatrix} = \frac{1}{7} \begin{pmatrix} 13e^{-2t} + 8e^{5t} \\ -26e^{-2t} + 40e^{5t} \end{pmatrix}$. Then $x = (13e^{-2t} + 8e^{5t})/7$.

20. $N_3^2 = \begin{pmatrix} 0 & 1 & 0 \\ 0 & 0 & 1 \\ 0 & 0 & 0 \end{pmatrix} \begin{pmatrix} 0 & 1 & 0 \\ 0 & 0 & 1 \\ 0 & 0 & 0 \end{pmatrix} = \begin{pmatrix} 0 & 0 & 1 \\ 0 & 0 & 0 \\ 0 & 0 & 0 \end{pmatrix}$; $N_3^3 = \begin{pmatrix} 0 & 0 & 1 \\ 0 & 0 & 0 \\ 0 & 0 & 0 \end{pmatrix} \begin{pmatrix} 0 & 1 & 0 \\ 0 & 0 & 1 \\ 0 & 0 & 0 \end{pmatrix} = \begin{pmatrix} 0 & 0 & 0 \\ 0 & 0 & 0 \\ 0 & 0 & 0 \end{pmatrix}$

21. $e^{N_3 t} = I + N_3 t + \frac{N_3^2 t^2}{2!} + \frac{N_3^3 t^3}{3!} + \dots$
 $= I + N_3 t + \frac{N_3^2 t^2}{2}$, since $N_3^m = 0$ for $m \geq 3$.
 $= \begin{pmatrix} 1 & 0 & 0 \\ 0 & 1 & 0 \\ 0 & 0 & 1 \end{pmatrix} + \begin{pmatrix} 0 & t & 0 \\ 0 & 0 & t \\ 0 & 0 & 0 \end{pmatrix} + \begin{pmatrix} 0 & 0 & t^2/2 \\ 0 & 0 & 0 \\ 0 & 0 & 0 \end{pmatrix} = \begin{pmatrix} 1 & t & t^2/2 \\ 0 & 1 & t \\ 0 & 0 & 1 \end{pmatrix}$.

22. $Jt = \lambda It + N_3 t$. Then $e^{Jt} = e^{(\lambda It + N_3 t)} = e^{\lambda It} e^{N_3 t}$. Then $e^{Jt} = \begin{pmatrix} e^{\lambda t} & 0 & 0 \\ 0 & e^{\lambda t} & 0 \\ 0 & 0 & e^{\lambda t} \end{pmatrix} \begin{pmatrix} 1 & t & t^2/2 \\ 0 & 1 & t \\ 0 & 0 & 1 \end{pmatrix} = e^{\lambda t} \begin{pmatrix} 1 & t & t^2/2 \\ 0 & 1 & t \\ 0 & 0 & 1 \end{pmatrix}$.

23. From Problem 6.6.20, $C = \begin{pmatrix} 1 & 1 & 0 \\ 1 & 2 & 1 \\ 0 & 1 & 0 \end{pmatrix}$; $C^{-1} = \begin{pmatrix} 1 & 0 & -1 \\ 0 & 0 & 1 \\ -1 & 1 & -1 \end{pmatrix}$; $J = \begin{pmatrix} -1 & 1 & 0 \\ 0 & -1 & 1 \\ 0 & 0 & -1 \end{pmatrix}$; $e^{At} = Ce^{Jt}C^{-1} = e^{-t} \begin{pmatrix} 1-t-t^2/2 & t+t^2/2 & -t^2/2 \\ -2t-t^2/2 & 1+2t+t^2/2 & -t-t^2/2 \\ -t & t & 1-t \end{pmatrix}$.

24. $C = \begin{pmatrix} -5 & 1/7 & 25/49 \\ -3 & 2/7 & 1/49 \\ 7 & 0 & 0 \end{pmatrix}$; $C^{-1} = \begin{pmatrix} 0 & 0 & 1/7 \\ -1/7 & 25/7 & 10/7 \\ 2 & -1 & 1 \end{pmatrix}$; $J = \begin{pmatrix} -2 & 1 & 0 \\ 0 & -2 & 1 \\ 0 & 0 & -2 \end{pmatrix}$; $e^{At} = Ce^{Jt}C^{-1} = e^{-2t} \begin{pmatrix} 1-3t/7-5t^2 & -18t+5t^2/2 & -7t-5t^2/2 \\ t-3t^2 & 1-11t+3t^2/2 & -4t-3t^2/2 \\ -t+7t^2 & 25t-7t^2/2 & 1+10t+7t^2/2 \end{pmatrix}$.

25. $J = \begin{pmatrix} \lambda & 1 & 0 & 0 \\ 0 & \lambda & 1 & 0 \\ 0 & 0 & \lambda & 1 \\ 0 & 0 & 0 & \lambda \end{pmatrix} = \lambda I + \begin{pmatrix} 0 & 1 & 0 & 0 \\ 0 & 0 & 1 & 0 \\ 0 & 0 & 0 & 1 \\ 0 & 0 & 0 & 0 \end{pmatrix}$. Note that $\begin{pmatrix} 0 & 1 & 0 & 0 \\ 0 & 0 & 1 & 0 \\ 0 & 0 & 0 & 1 \\ 0 & 0 & 0 & 0 \end{pmatrix}^4 = 0$. Then $e^{Jt} = e^{\lambda t} \begin{pmatrix} 1 & t & t^2/2 & t^3/6 \\ 0 & 1 & t & t^2/2 \\ 0 & 0 & 1 & t \\ 0 & 0 & 0 & 1 \end{pmatrix}$.

$$26. e^{At} = \begin{pmatrix} e^{2t} & te^{2t} & 0 & 0 \\ 0 & e^{2t} & 0 & 0 \\ 0 & 0 & e^{3t} & te^{3t} \\ 0 & 0 & 0 & e^{3t} \end{pmatrix}. \text{ (Apply the above results to each block.)}$$

$$27. e^{At} = \begin{pmatrix} e^{-4t} & te^{-4t} & t^2e^{-4t}/2 & 0 \\ 0 & e^{-4t} & te^{-4t} & 0 \\ 0 & 0 & e^{-4t} & 0 \\ 0 & 0 & 0 & e^{3t} \end{pmatrix}.$$

Section 6.8

1. (a) $p(A) = A^2 + A - 12I$; (b) $p(A) = \begin{pmatrix} 14 & 2 \\ 5 & 11 \end{pmatrix} + \begin{pmatrix} -2 & -2 \\ -5 & 1 \end{pmatrix} - \begin{pmatrix} 12 & 0 \\ 0 & 12 \end{pmatrix} = \begin{pmatrix} 0 & 0 \\ 0 & 0 \end{pmatrix}$;
 (c) $A^{-1} = -\frac{1}{12}(A + I) = -\frac{1}{12} \left[-\begin{pmatrix} -2 & -2 \\ -5 & 1 \end{pmatrix} - \begin{pmatrix} 1 & 0 \\ 0 & 1 \end{pmatrix} \right] = \begin{pmatrix} -1/12 & -1/6 \\ -5/12 & 1/6 \end{pmatrix}$.
2. (a) $p(A) = A^2 + I$; (b) $p(A) = \begin{pmatrix} -1 & 0 \\ 0 & -1 \end{pmatrix} + \begin{pmatrix} 1 & 0 \\ 0 & 1 \end{pmatrix} = \begin{pmatrix} 0 & 0 \\ 0 & 0 \end{pmatrix}$;
 (c) $A^{-1} = -A = -\begin{pmatrix} 2 & -1 \\ 5 & -2 \end{pmatrix} = \begin{pmatrix} -2 & 1 \\ -5 & 2 \end{pmatrix}$.
3. (a) $p(A) = A^3 - 4A^2 + 3A$; (b) $p(A) = \begin{pmatrix} 5 & -9 & 4 \\ -9 & 18 & -19 \\ 4 & -9 & 5 \end{pmatrix} - 4 \begin{pmatrix} 2 & -3 & 1 \\ -3 & 6 & -3 \\ 1 & -3 & 2 \end{pmatrix} + 3 \begin{pmatrix} 1 & -1 & 0 \\ -1 & 2 & -1 \\ 0 & -1 & 1 \end{pmatrix} = \begin{pmatrix} 0 & 0 & 0 \\ 0 & 0 & 0 \\ 0 & 0 & 0 \end{pmatrix}$; (c) A is not invertible, as constant term is 0.
4. (a) $p(A) = A^3 - 5A^2 + 8A - 4I$;
 (b) $p(A) = \begin{pmatrix} -9 & 34 & 24 \\ -5 & 18 & 12 \\ -7 & 14 & 8 \end{pmatrix} - 5 \begin{pmatrix} -1 & 10 & 8 \\ -1 & 6 & 4 \\ -3 & 6 & 4 \end{pmatrix} + 8 \begin{pmatrix} 1 & 2 & 2 \\ 0 & 2 & 1 \\ -1 & 2 & 2 \end{pmatrix} - \begin{pmatrix} 4 & 0 & 0 \\ 0 & 4 & 0 \\ 0 & 0 & 4 \end{pmatrix} = \begin{pmatrix} 0 & 0 & 0 \\ 0 & 0 & 0 \\ 0 & 0 & 0 \end{pmatrix}$;
 (c) $A^{-1} = \frac{-1}{4} \left[-\begin{pmatrix} -1 & 10 & 8 \\ -1 & 6 & 4 \\ -3 & 6 & 4 \end{pmatrix} + 5 \begin{pmatrix} 1 & 2 & 2 \\ 0 & 2 & 1 \\ -1 & 2 & 2 \end{pmatrix} - 8 \begin{pmatrix} 1 & 0 & 0 \\ 0 & 1 & 0 \\ 0 & 0 & 1 \end{pmatrix} \right] = \begin{pmatrix} 1/2 & 0 & -1/2 \\ -1/4 & 1 & -1/4 \\ 1/2 & -1 & 1/2 \end{pmatrix}$.
5. (a) $p(A) = A^3 - 3A^2 + 3A - I$;
 (b) $p(A) = \begin{pmatrix} 1 & -3 & 3 \\ 3 & -8 & 6 \\ 6 & -15 & 10 \end{pmatrix} - 3 \begin{pmatrix} 0 & 0 & 1 \\ 1 & -3 & 3 \\ 3 & -8 & 6 \end{pmatrix} + 3 \begin{pmatrix} 0 & 1 & 0 \\ 0 & 0 & 1 \\ 1 & -3 & 3 \end{pmatrix} - \begin{pmatrix} 1 & 0 & 0 \\ 0 & 1 & 0 \\ 0 & 0 & 1 \end{pmatrix} = \begin{pmatrix} 0 & 0 & 0 \\ 0 & 0 & 0 \\ 0 & 0 & 0 \end{pmatrix}$;
 (c) $A^{-1} = - \left[-\begin{pmatrix} 0 & 0 & 1 \\ 1 & -3 & 3 \\ 3 & -8 & 6 \end{pmatrix} + 3 \begin{pmatrix} 0 & 1 & 0 \\ 0 & 0 & 1 \\ 1 & -3 & 3 \end{pmatrix} - 3 \begin{pmatrix} 1 & 0 & 0 \\ 0 & 1 & 0 \\ 0 & 0 & 1 \end{pmatrix} \right] = \begin{pmatrix} 3 & -3 & 1 \\ 1 & 0 & 0 \\ 0 & 1 & 0 \end{pmatrix}$.
6. (a) $p(A) = A^3 - 3A^2 + 3A - I$;
 (b) $p(A) = \begin{pmatrix} -20 & -30 & -33 \\ 9 & 13 & 15 \\ 6 & 9 & 10 \end{pmatrix} - 3 \begin{pmatrix} -10 & -17 & -16 \\ 5 & 8 & 8 \\ 3 & 5 & 5 \end{pmatrix} + 3 \begin{pmatrix} -3 & -7 & -5 \\ 2 & 4 & 3 \\ 1 & 2 & 2 \end{pmatrix} - \begin{pmatrix} 1 & 0 & 0 \\ 0 & 1 & 0 \\ 0 & 0 & 1 \end{pmatrix} = \begin{pmatrix} 0 & 0 & 0 \\ 0 & 0 & 0 \\ 0 & 0 & 0 \end{pmatrix}$;
 (c) $A^{-1} = - \left[-\begin{pmatrix} -10 & -17 & -16 \\ 5 & 8 & 8 \\ 3 & 5 & 5 \end{pmatrix} + 3 \begin{pmatrix} -3 & -7 & -5 \\ 2 & 4 & 3 \\ 1 & 2 & 2 \end{pmatrix} - 3 \begin{pmatrix} 1 & 0 & 0 \\ 0 & 1 & 0 \\ 0 & 0 & 1 \end{pmatrix} \right] = \begin{pmatrix} 2 & 4 & -1 \\ -1 & -1 & -1 \\ 0 & -1 & 2 \end{pmatrix}$.
7. (a) $p(A) = A^3 - 6A^2 - 18A - 9I$;
 (b) $p(A) = \begin{pmatrix} 63 & 54 & 108 \\ 180 & 189 & 324 \\ 168 & 204 & 315 \end{pmatrix} - 6 \begin{pmatrix} 3 & 12 & 9 \\ 18 & 27 & 36 \\ 25 & 19 & 42 \end{pmatrix} - 18 \begin{pmatrix} 2 & -1 & 3 \\ 4 & 1 & 6 \\ 1 & 5 & 3 \end{pmatrix} - 9 \begin{pmatrix} 1 & 0 & 0 \\ 0 & 1 & 0 \\ 0 & 0 & 1 \end{pmatrix} = \begin{pmatrix} 0 & 0 & 0 \\ 0 & 0 & 0 \\ 0 & 0 & 0 \end{pmatrix}$;
 (c) $A^{-1} = \frac{-1}{9} \left[-\begin{pmatrix} 3 & 12 & 9 \\ 18 & 27 & 36 \\ 25 & 19 & 42 \end{pmatrix} + 6 \begin{pmatrix} 2 & -1 & 3 \\ 4 & 1 & 6 \\ 1 & 5 & 3 \end{pmatrix} + 18 \begin{pmatrix} 1 & 0 & 0 \\ 0 & 1 & 0 \\ 0 & 0 & 1 \end{pmatrix} \right] = \begin{pmatrix} -3 & 2 & -1 \\ -2/3 & 1/3 & 0 \\ 19/9 & -11/9 & 2/3 \end{pmatrix}$.

8. (a) $p(A) = A^4 - A^2 - A - 9I$;

(b) $p(A) = \begin{pmatrix} 10 & 0 & 2 & 1 \\ 10 & 11 & 0 & 0 \\ 2 & 1 & 7 & 1 \\ 11 & 0 & 3 & 10 \end{pmatrix} - \begin{pmatrix} 0 & 0 & 1 & 1 \\ 8 & 3 & 0 & -2 \\ 3 & 1 & -2 & 0 \\ 7 & -1 & 4 & 1 \end{pmatrix} - \begin{pmatrix} 1 & 0 & 1 & 0 \\ 2 & -1 & 0 & 2 \\ -1 & 0 & 0 & 1 \\ 4 & 1 & -1 & 0 \end{pmatrix} - 9 \begin{pmatrix} 1 & 0 & 0 & 0 \\ 0 & 1 & 0 & 0 \\ 0 & 0 & 1 & 0 \\ 0 & 0 & 0 & 1 \end{pmatrix} = \begin{pmatrix} 0 & 0 & 0 & 0 \\ 0 & 0 & 0 & 0 \\ 0 & 0 & 0 & 0 \\ 0 & 0 & 0 & 0 \end{pmatrix}$;

(c) $A^{-1} = -\frac{1}{9} \left[-\begin{pmatrix} 3 & 1 & -1 & 1 \\ 6 & -5 & 10 & 6 \\ 7 & -1 & 3 & 0 \\ 5 & 2 & 6 & 2 \end{pmatrix} + \begin{pmatrix} 1 & 0 & 1 & 0 \\ 2 & -1 & 0 & 2 \\ -1 & 0 & 0 & 1 \\ 4 & 1 & -1 & 0 \end{pmatrix} + \begin{pmatrix} 1 & 0 & 0 & 0 \\ 0 & 1 & 0 & 0 \\ 0 & 0 & 1 & 0 \\ 0 & 0 & 0 & 1 \end{pmatrix} \right] = \begin{pmatrix} 1/9 & 1/9 & -2/9 & 1/9 \\ 4/9 & -5/9 & 10/9 & 4/9 \\ 8/9 & -1/9 & 2/9 & -1/9 \\ 1/9 & 1/9 & 7/9 & 1/9 \end{pmatrix}$.

9. (a) $p(A) = (A - aI)^4$; (b) $p(A) = \begin{pmatrix} 0 & b & 0 & 0 \\ 0 & 0 & c & 0 \\ 0 & 0 & 0 & d \\ 0 & 0 & 0 & 0 \end{pmatrix}^4 = \begin{pmatrix} 0 & 0 & 0 & 0 \\ 0 & 0 & 0 & 0 \\ 0 & 0 & 0 & 0 \\ 0 & 0 & 0 & 0 \end{pmatrix}$; (c) If $a = 0$, then A does not have an

inverse. If $a \neq 0$, then $A^{-1} = \frac{1}{a^4} \left[-\begin{pmatrix} a^3 & 3a^2b & 3abc & bcd \\ 0 & a^3 & 3a^2c & 3acd \\ 0 & 0 & a^3 & 3a^2d \\ 0 & 0 & 0 & a^3 \end{pmatrix} + 4a \begin{pmatrix} a^2 & 2ab & bc & 0 \\ 0 & a^2 & 2ac & cd \\ 0 & 0 & a^2 & 2ad \\ 0 & 0 & 0 & a^2 \end{pmatrix} - 6a^2 \begin{pmatrix} a & b & 0 & 0 \\ 0 & a & c & 0 \\ 0 & 0 & a & d \\ 0 & 0 & 0 & a \end{pmatrix} + 4a^3 \begin{pmatrix} 1 & 0 & 0 & 0 \\ 0 & 1 & 0 & 0 \\ 0 & 0 & 1 & 0 \\ 0 & 0 & 0 & 1 \end{pmatrix} \right] = \begin{pmatrix} 1/a & -b/a^2 & cb/a^3 & -bcd/a^4 \\ 0 & 1/a & -c/a^2 & cd/a^3 \\ 0 & 0 & 1/a & -d/a^2 \\ 0 & 0 & 0 & 1/a \end{pmatrix}$.

10. $a_{11} = 2, a_{22} = 5, a_{33} = 6, r_1 = 1, r_2 = 1, \text{ and } r_3 = 1; |\lambda - 2| \leq 1, |\lambda - 5| \leq 1, \text{ or } |\lambda - 6| \leq 1; |\lambda| \leq 7$ and $\text{Re } \lambda \geq 1$.

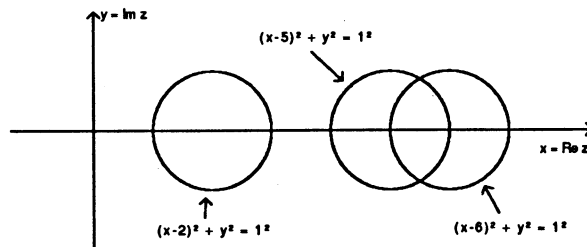

11. $a_{11} = 3, a_{22} = 6, a_{33} = 5, a_{44} = 4, r_1 = 5/6, r_2 = 1, r_3 = 1, \text{ and } r_4 = 1; |\lambda - 3| \leq 5/6, |\lambda - 6| \leq 1, |\lambda - 5| \leq 1, \text{ or } |\lambda - 4| \leq 1; |\lambda| \leq 7$ and $\text{Re } \lambda \geq 13/6$.

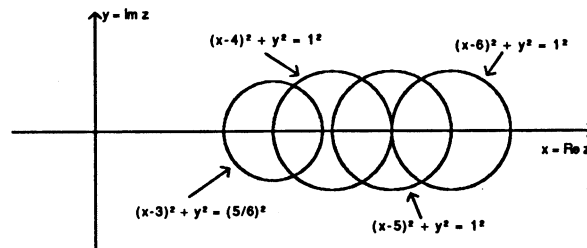

12. $a_{11} = 1, a_{22} = 5, a_{33} = 6, a_{44} = 4, r_1 = 8, r_2 = 9, r_3 = 5,$ and $r_4 = 5; |\lambda - 1| \leq 8, |\lambda - 5| \leq 9, |\lambda - 6| \leq 5,$ or $|\lambda - 4| \leq 5; |\lambda| \leq 14$ and $\text{Re } \lambda \geq -7.$

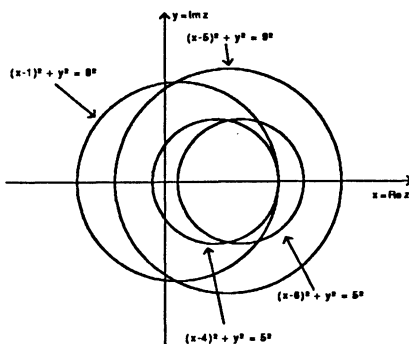

13. $a_{11} = -7, a_{22} = -10, a_{33} = 5, a_{44} = 4, r_1 = 4/5, r_2 = 1/2, r_3 = 3/4,$ and $r_4 = 1; |\lambda + 7| \leq 4/5, |\lambda + 10| \leq 1/2, |\lambda - 5| \leq 3/4,$ or $|\lambda - 4| \leq 1; |\lambda| \leq 21/2$ and $-21/2 \leq \text{Re } \lambda \leq 23/4.$

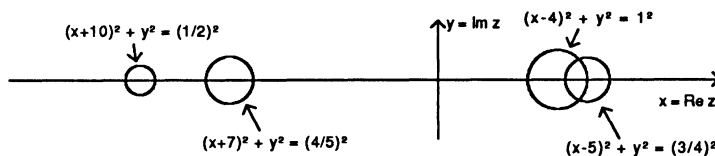

14. $a_{11} = 3, a_{22} = 5, a_{33} = 4, a_{44} = 3, a_{55} = 2, a_{66} = 0, r_1 = 1, r_2 = 2, r_3 = 6/5, r_4 = 1, r_5 = 3/2,$ and $r_6 = 1; |\lambda - 3| \leq 1, |\lambda - 5| \leq 2, |\lambda - 4| \leq 6/5, |\lambda + 3| \leq 1, |\lambda - 2| \leq 3/2,$ or $|\lambda| = 1; |\lambda| \leq 7$ and $\text{Re } \lambda \geq -4.$

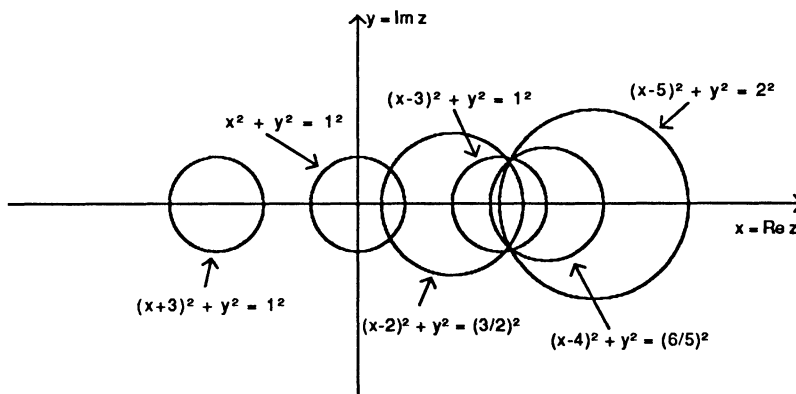

15. As A is symmetric, the eigenvalues are real. By Gershgorin's theorem, we have $\lambda = \text{Re } \lambda \geq 4 - (2 + 1 + 1/4) = 3/4.$
16. As A is symmetric, the eigenvalues are real, and by Gershgorin's theorem, $-6 - (1 + 2 + 1) = -10 \leq \text{Re } \lambda = \lambda \leq -4 - (1 + 1 + 1) = -1.$

17. (a) $F(\lambda) = (B_0 + B_1\lambda)(C_0 + C_1\lambda) = B_0C_0 + (B_0C_1 + B_1C_0)\lambda + B_1C_1\lambda^2$;
(b) $P(A)Q(A) = B_0C_0 + B_1AC_0 + B_0C_1A + B_1AC_1A$ and $F(A) = B_0C_0 + (B_0C_1 + B_1C_0)A + B_1C_1A^2$.
So $F(A) = P(A)Q(A)$ if and only if $AC_0 = C_0A$ and $AC_1A = C_1A^2$.
18. As $|a_{ii} - \lambda_i| \leq r_i$ then $|\lambda_i| \leq |a_{ii}| + r_i$, for $i = 1, 2, \dots, n$. Hence $r(A) = \max_i |\lambda_i| \leq \max_i (|a_{ii}| + r_i) = |A|$.
19. $\det A = \lambda_1\lambda_2 \cdots \lambda_n$. If $\lambda_i = 0$ for some i , then $|a_{ii} - \lambda_i| \leq r_i$, so that $|a_{ii}| \leq r_i$, which is impossible since A is strictly diagonally dominant. Hence $\lambda_i \neq 0$ for $i = 1, 2, \dots, n$ and $\det A \neq 0$.

MATLAB 6.8

1. For problem 1 in 6.1

```
>> A = [ -2 -2 ; -5 1];
```

and its characteristic polynomial is $\det(A - \lambda I) = (-2 - \lambda)(1 - \lambda) - (-2)(-5) = \lambda^2 + \lambda - 12 = (\lambda - 3)(\lambda + 4)$. So to check Cayley-Hamilton we calculate:

```
>> A^2+A-12*eye(2) % This is zero so Cayley-Hamilton verified
ans =
     0     0
     0     0
```

To find the inverse we note Cayley-Hamilton implies $A^2 + A = 12I$, or $(1/12)(A + I)A = I$. Thus the inverse of A is:

```
>> (1/12)*(A+eye(2))
ans =
   -0.0833   -0.1667
   -0.4167    0.1667
>> ans-inv(A) % This is essentially zero - thus verifying (1/12)(A+I) is inv(A)
ans =
  1.0e-16 *
   0.1388    0.2776
   0.5551   -0.2776
```

For problem 13 in 6.1

```
>> A = [ 1 -1 -1; 1 -1 0; 1 0 -1];
```

and its characteristic polynomial is $\det(A - \lambda I) = (-1 - \lambda)(\lambda^2 + 1) = -1 - \lambda - \lambda^2 - \lambda^3$ from the solution to 6.1.13 or MATLAB 6.1.3 for problem 13. Now to verify the Cayley-Hamilton theorem we compute $p(A)$ using the factored form:

```
>> (-1*eye(3)-A)*(A^2+eye(3)) % This is zero - verifying Cayley-Hamilton
ans =
     0     0     0
     0     0     0
     0     0     0
```

For the inverse of A , use Cayley-Hamilton to deduce $I = -A - A^2 - A^3$. Then factoring out an A yields $A(-I - A - A^2) = I$ so A^{-1} is:

```
>> -eye(3)-A-A^2
ans =
   -1     1     1
   -1     0     1
   -1     1     0
>> ans-inv(A) % This is zero, verifying that inv(A) = -I-A-A^2
ans =
     0     0     0
     0     0     0
     0     0     0
```

2. (a)

```

>> A=10*rand(4)-5*eye(4)
A =
   -2.8104    9.3469    0.3457    0.0770
    0.4704   -1.1650    0.5346    3.8342
    6.7886    5.1942    0.2970    0.6684
    6.7930    8.3097    6.7115   -0.8251
>> c=poly(A) % This gives the negative of the characteristic polynomial
c =
   1.0e+03 *
   0.0010    0.0045   -0.0413   -0.5349   -1.9534
>> % polyvalm(c,A) evaluates the polynomial, coefficients in c, at the matrix A
>> polyvalm(c,A) % This is zero up to round-off (relative error 1e-14)
ans =
   1.0e-10 *
   0.0864    0.1433    0.0613    0.0485
   0.0790    0.1728    0.0605    0.0713
   0.1148    0.2171    0.0978    0.0989
   0.1872    0.3786    0.1453    0.1728

```

(b) Since $A^4+c(2)A^3+c(3)A^2+c(4)A+c(5)I = O$, we see that $A(A^3+c(2)A^2+c(3)A+c(4)I) = -c(5)I$. Thus if $c(5) \neq 0$, the following gives A^{-1} :

```

>> (-1/c(5))*(A^3+c(2)*A^2+c(3)*A+c(4)*eye(4))
ans =
   -0.0691   -0.0196    0.1203   -0.0002
    0.0871   -0.0103    0.0423   -0.0055
   -0.0331    0.0635   -0.1714    0.1532
    0.0396    0.2512    0.0220   -0.0230
>> ans - inv(A) % Zero up to relative error about 1e-14
ans =
   1.0e-14 *
    0.0278    0.0656    0.0305    0.0393
    0.0527    0.0911    0.0409    0.0343
    0.0611    0.1374    0.0389    0.0611
    0.1145    0.2331    0.0840    0.0864

```

(c)

```

>> A=A+i*(5*rand(4)-2*ones(4,4)) % Use previous A for real part
A =
   -2.8104 - 0.9052i    9.3469 + 2.6735i    0.3457 - 1.8271i    0.0770 - 1.9615i
    0.4704 - 1.7648i   -1.1650 - 0.0825i    0.5346 - 1.7327i    3.8342 - 0.0829i
    6.7886 + 1.3943i    5.1942 + 0.5971i    0.2970 + 0.6485i    0.6684 - 1.6658i
    6.7930 + 1.3965i    8.3097 + 2.1548i    6.7115 + 1.3557i   -0.8251 + 0.0874i
>> c=poly(A) % c has coefficients for -p(t)
c = % the negative of characteristic polynomial
   1.0e+03 *
Columns 1 through 4
    0.0010          0.0045 + 0.0003i   -0.0541 + 0.0501i   -0.5477 + 0.1642i
Column 5
   -1.5172 - 0.7405i

```

```

>> polyvalm(c,A) % Zero up to round-off, showing A satisfies p(A)=0
ans =
    1.0e-11 *
    0.1364 - 0.0568i    0.2643 + 0.0909i    0.0455 + 0.0682i   -0.0568 - 0.1933i
    0.0483 - 0.0682i    0.1819 - 0.0909i    0.0261 - 0.0938i    0.1236 - 0.0227i
    0.1478 - 0.0909i    0.2615 - 0.3070i    0.0909 - 0.1933i    0.1478 + 0.0284i
    0.2686 - 0.1535i    0.5031 - 0.0171i    0.1638 - 0.0654i    0.1819 - 0.0682i
>> (-1/c(5))*(A^3+c(2)*A^2+c(3)*A+c(4)*eye(4)) % See b for derivation
ans =
   -0.0585 + 0.0445i   -0.0573 + 0.0143i    0.1330 + 0.0152i   -0.0214 - 0.0433i
    0.0996 - 0.0228i    0.0096 + 0.0809i    0.0419 - 0.0294i   -0.0201 + 0.0256i
   -0.0642 - 0.0317i    0.0888 - 0.1203i   -0.1892 + 0.0135i    0.1936 - 0.0048i
    0.0420 - 0.0608i    0.3031 + 0.0601i    0.0111 - 0.0358i   -0.0109 + 0.0908i
>> ans - inv(A) % Zero up to relative error about 1e-14
ans =
    1.0e-15 *
    0.0833 - 0.0416i   -0.0555 - 0.1839i   -0.0833 - 0.1631i    0.1527 + 0.0069i
    0.0416 - 0.0867i    0.1388 - 0.0555i    0.0694 - 0.0312i   -0.0382
         0 - 0.1110i    0.3192 - 0.1110i    0.0833 - 0.0104i    0.0833 - 0.1353i
    0.1596 - 0.1457i    0.5551 - 0.1665i    0.0607 - 0.1457i    0.1422 + 0.0139i

```

3. (a) Find centers and radii of Gersgorin circles for random 2×2 .

```

>> A=6*rand(2)-3*ones(2,2)
A =
   -1.6862    1.0732
   -2.7177    1.0758
>> A1=6*rand(2)-3*ones(2,2); % More random matrices may show other patterns
>> A2=6*rand(2)-3*ones(2,2);

>> r1=sum(abs(A(1,:)))-abs(A(1,1))
r1 =
    1.0732
>> r2=sum(abs(A(2,:)))-abs(A(2,2))
r2 =
    2.7177
>> a1=real(A(1,1)), b1=imag(A(1,1))
a1 =
   -1.6862
b1 =
     0
>> a2=real(A(2,2)), b2=imag(A(2,2))
a2 =
    1.0758
b2 =
     0

```

Now compute coordinates for top and bottom halves of first circle

```

>> xx=-r1:2*r1/100:r1;
>> x=xx+a1;
>> z=real(sqrt(r1*r1-xx.*xx));
>> y=z+b1;yy=-z+b1;
>> x1=[x fliplr(x)];
>> y1=[y yy];

```

Now compute coordinates for top and bottom halves of second circle

```
>> xx=-r2:2*r2/100:r2;
>> x=xx+a2;
>> z=real(sqrt(r2*r2-xx.*xx));
>> y=z+b2;yy=-z+b2;
>> x2=[x fliplr(x)];
>> y2=[y yy];
```

Now compute the eigenvalues and plot the circles and eigenvalues: (We compute eig(A) first, rather than after starting the plots since the text's placement leads to separate plots in some versions of MATLAB)

```
>> e = eig(A) % In the text this appears between hold on and 2nd plot
e =
    -0.3052 + 1.0047i
    -0.3052 - 1.0047i
>> axis('square')
>> plot(x1,y1,'b:',x2,y2,'g-') % Blue - dotted, Green - solid
>> hold on % So printed circles distinguishable
>> plot(real(e),imag(e),'w*')
>> hold off
>> print -deps fig683a.eps
```

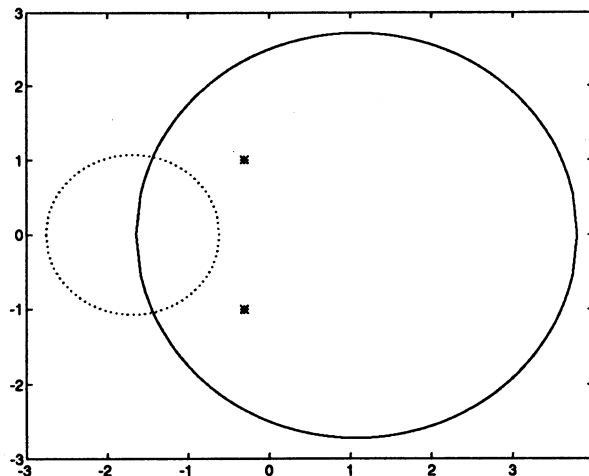

Observe that each of the eigenvalues, plotted as '*', are always inside at least one of the circles. When the random matrix has complex eigenvalues, they are complex conjugates, and so both lie inside one circle. If the eigenvalues of the real matrix A are real, then each one may be in a different circle.

Here are the raw data and plot for a second example with real eigenvalues.

```
>> % Here's the picture with A2 computed above.
>> A2
A2 =
    -2.7926    0.1782
    -2.6792    1.0269
>> % With eigenvalues
>> e = eig(A2)
e =
    -2.6632
     0.8975
>> % Redo all the plot preparation and plotting for this A2 to get
```

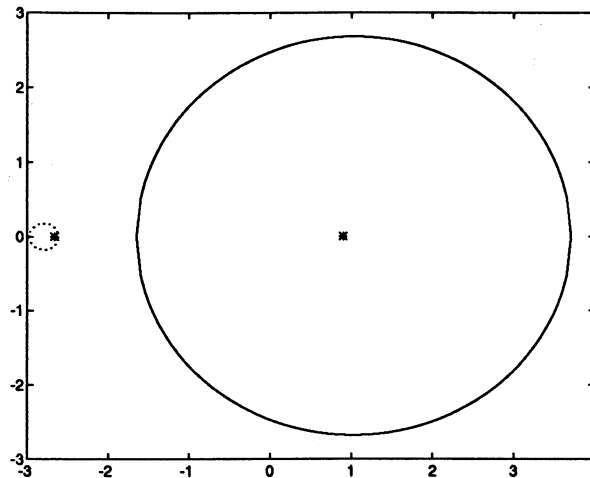

(b) Find centers and radii of Gersgorin circles for a random 2×2 complex matrix.

```
>> A=8*rand(2)-5*ones(2,2)+i*(6*rand(2)-3*ones(2,2))
A =
  -4.7234 - 2.9538i  -0.7624 - 2.5989i
  -4.5723 - 0.6995i   0.3692 - 0.4951i

>> r1=sum(abs(A(1,:)))-abs(A(1,1))
r1 =
    2.7085
>> r2=sum(abs(A(2,:)))-abs(A(2,2))
r2 =
    4.6255

>> a1=real(A(1,1)), b1=imag(A(1,1))
a1 =
  -4.7234
b1 =
  -2.9538
>> a2=real(A(2,2)), b2=imag(A(2,2))
a2 =
    0.3692
b2 =
  -0.4951
```

Now compute coordinates for top and bottom halves of first circle

```
>> xx=-r1:2*r1/100:r1;
>> x=xx+a1;
>> z=real(sqrt(r1*r1-xx.*xx));
>> y=z+b1;yy=-z+b1;
>> x1=[x fliplr(x)];
>> y1=[y yy];
```

Now compute coordinates for top and bottom halves of second circle

```
>> xx=-r2:2*r2/100:r2;
>> x=xx+a2;
>> z=real(sqrt(r2*r2-xx.*xx));
>> y=z+b2;yy=-z+b2;
>> x2=[x fliplr(x)];
>> y2=[y yy];
```

Now compute the eigenvalues and plot the circles and eigenvalues:

```
>> e = eig(A) % Compute this first so it doesn't interfere with plot
e =
  -5.8146 - 4.2918i
   1.4604 + 0.8429i
>> axis('square')
>> plot(x1,y1,'b:',x2,y2,'g-')
>> hold on
>> plot(real(e),imag(e),'w*')
>> hold off
>> print -deps fig683b.eps
```

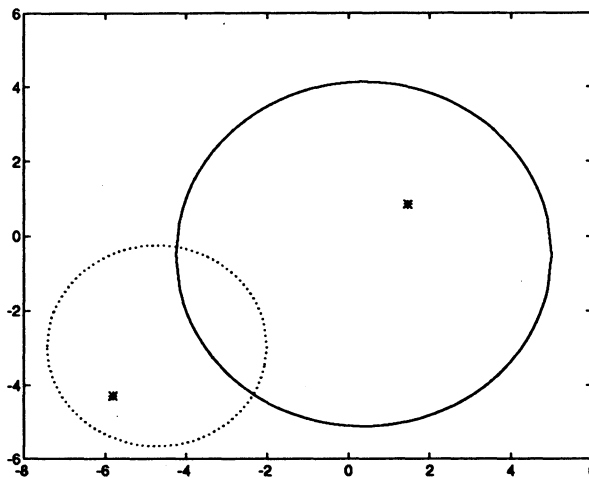

(c) Find centers and radii of Gershgorin circles for a random 3x3 complex matrix.

```
>> A=6*rand(3)-3*ones(3,3)+i*(8*rand(3)-4*ones(3,3))
A =
  -1.6862 - 3.5723i   1.0758 - 3.9384i   0.1165 - 0.6601i
  -2.7177 + 0.2376i   2.6082 - 0.9327i   1.9858 + 1.4942i
   1.0732 + 1.3692i  -0.6990 - 3.4653i  -2.7926 + 0.7118i

>> r1=sum(abs(A(1,:)))-abs(A(1,1))
r1 =
   4.7530
>> r2=sum(abs(A(2,:)))-abs(A(2,2))
r2 =
   5.2132
>> r3=sum(abs(A(3,:)))-abs(A(3,3))
r3 =
   5.2747

>> a1=real(A(1,1)), b1=imag(A(1,1))
a1 =
  -1.6862
b1 =
  -3.5723
```

```

>> a2=real(A(2,2)), b2=imag(A(2,2))
a2 =
    2.6082
b2 =
   -0.9327

>> a3=real(A(3,3)), b3=imag(A(3,3))
a3 =
   -2.7926
b3 =
    0.7118

```

Now compute coordinates for top and bottom halves of first circle

```

>> xx=-r1:2*r1/100:r1;
>> x=xx+a1;
>> z=real(sqrt(r1*r1-xx.*xx));
>> y=z+b1;yy=-z+b1;
>> x1=[x fliplr(x)];
>> y1=[y yy];

```

Now compute coordinates for top and bottom halves of second circle

```

>> xx=-r2:2*r2/100:r2;
>> x=xx+a2;
>> z=real(sqrt(r2*r2-xx.*xx));
>> y=z+b2;yy=-z+b2;
>> x2=[x fliplr(x)];
>> y2=[y yy];

```

Now compute coordinates for top and bottom halves of first circle

```

>> xx=-r3:2*r3/100:r3;
>> x=xx+a3;
>> z=real(sqrt(r3*r3-xx.*xx));
>> y=z+b3;yy=-z+b3;
>> x3=[x fliplr(x)];
>> y3=[y yy];

```

Now compute the eigenvalues and plot the circles and eigenvalues:

```

>> e = eig(A) % In the text this appears between hold on and 2nd plot
e =
   -2.4763 - 5.1109i
    4.3118 - 0.4596i
   -3.7061 + 1.7773i
>> % In some versions of MATLAB the later placement leads to separate plots
>> axis('square')
>> plot(x1,y1,'b:',x2,y2,'g-',x3,y3,'r--')
>> hold on
>> plot(real(e),imag(e),'w*')
>> hold off
>> print -deps fig683c.eps

```

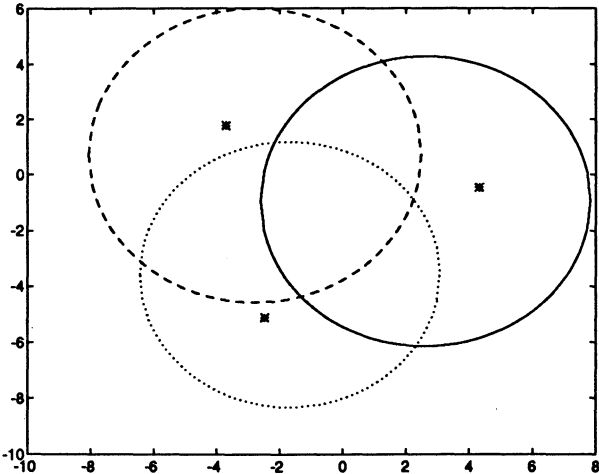
Review Exercises for Chapter 6

- $p(\lambda) = (\lambda + 2)(\lambda - 4)$; the eigenvalues are -2 and 4 ; $E_{-2} = \text{span} \left\{ \begin{pmatrix} 2 \\ 1 \end{pmatrix} \right\}$ and $E_4 = \text{span} \left\{ \begin{pmatrix} 1 \\ 1 \end{pmatrix} \right\}$.
- $p(\lambda) = (\lambda - 2)^2$; the matrix has 2 as an eigenvalue; $E_2 = \text{span} \left\{ \begin{pmatrix} 1 \\ 0 \end{pmatrix} \right\}$.
- $p(\lambda) = (\lambda - 1)(\lambda - 7)(\lambda + 5)$; the eigenvalues are 1 , 7 , and -5 ; $E_1 = \text{span} \left\{ \begin{pmatrix} -6 \\ 3 \\ 4 \end{pmatrix} \right\}$, $E_7 = \text{span} \left\{ \begin{pmatrix} 0 \\ 3 \\ 1 \end{pmatrix} \right\}$, and $E_{-5} = \text{span} \left\{ \begin{pmatrix} 0 \\ 0 \\ 1 \end{pmatrix} \right\}$.
- $p(\lambda) = (\lambda - 1)(\lambda + 1)(\lambda + 5)$; the eigenvalues are 1 , -1 , and -5 ; $E_1 = \text{span} \left\{ \begin{pmatrix} -1 \\ 0 \\ 1 \end{pmatrix} \right\}$, $E_{-1} = \text{span} \left\{ \begin{pmatrix} 1 \\ 2 \\ -7 \end{pmatrix} \right\}$, and $E_{-5} = \text{span} \left\{ \begin{pmatrix} -1 \\ 1 \\ 1 \end{pmatrix} \right\}$.
- $p(\lambda) = (\lambda - 3)(\lambda - 1)(\lambda^2 - 6\lambda + 11)$; the eigenvalues are 3 , 1 , $3 + i\sqrt{2}$, and $3 - i\sqrt{2}$; $E_3 = \text{span} \left\{ \begin{pmatrix} 1 \\ 1 \\ 0 \\ 0 \end{pmatrix} \right\}$, $E_1 = \text{span} \left\{ \begin{pmatrix} 1 \\ 2 \\ 0 \\ 0 \end{pmatrix} \right\}$, $E_{3+i\sqrt{2}} = \text{span} \left\{ \begin{pmatrix} 0 \\ 0 \\ -1 \\ i\sqrt{2} \end{pmatrix} \right\}$, and $E_{3-i\sqrt{2}} = \text{span} \left\{ \begin{pmatrix} 0 \\ 0 \\ 1 \\ i\sqrt{2} \end{pmatrix} \right\}$.
- $p(\lambda) = (\lambda + 2)^3$; the matrix has -2 as an eigenvalue; $E_{-2} = \text{span} \left\{ \begin{pmatrix} 1 \\ 0 \\ 0 \end{pmatrix} \right\}$.
- A has eigenvalues 2 and -3 , with corresponding eigenvectors $\begin{pmatrix} -3 \\ 4 \end{pmatrix}$ and $\begin{pmatrix} 1 \\ -1 \end{pmatrix}$. Hence $C = \begin{pmatrix} -3 & 1 \\ 4 & -1 \end{pmatrix}$ and $C^{-1}AC = \begin{pmatrix} 2 & 0 \\ 0 & -3 \end{pmatrix}$.
- A has eigenvalues 1 and $-1/2$, with corresponding eigenvectors $\begin{pmatrix} -3 \\ 5 \end{pmatrix}$ and $\begin{pmatrix} -1 \\ 2 \end{pmatrix}$. So $C = \begin{pmatrix} -3 & -1 \\ 5 & 2 \end{pmatrix}$ and $C^{-1}AC = \begin{pmatrix} 1 & 0 \\ 0 & -1/2 \end{pmatrix}$.
- A has eigenvalues -1 , i , and $-i$, with corresponding eigenvectors $\begin{pmatrix} 0 \\ -1 \\ 1 \end{pmatrix}$, $\begin{pmatrix} -1-i \\ 1 \\ 1 \end{pmatrix}$, and $\begin{pmatrix} -1+i \\ 1 \\ 1 \end{pmatrix}$. Thus $C = \begin{pmatrix} 0 & -1-i & -1+i \\ -1 & 1 & 1 \\ 1 & 1 & 1 \end{pmatrix}$ and $C^{-1}AC = \begin{pmatrix} -1 & 0 & 0 \\ 0 & i & 0 \\ 0 & 0 & -i \end{pmatrix}$.

10. The eigenvalues of A are 2, 6, and -3 , with corresponding eigenvectors $\begin{pmatrix} -1 \\ 1 \\ 0 \end{pmatrix}$, $\begin{pmatrix} 1 \\ 1 \\ 0 \end{pmatrix}$, and $\begin{pmatrix} 0 \\ 0 \\ 1 \end{pmatrix}$. So

$$Q = \begin{pmatrix} -1/\sqrt{2} & 1/\sqrt{2} & 0 \\ 1/\sqrt{2} & 1/\sqrt{2} & 0 \\ 0 & 0 & 1 \end{pmatrix} \text{ and } Q^t A Q = \begin{pmatrix} 2 & 0 & 0 \\ 0 & 6 & 0 \\ 0 & 0 & -3 \end{pmatrix}.$$

11. The matrix A has 1 as an eigenvalue, with $E_1 = \text{span} \left\{ \begin{pmatrix} 1 \\ 1 \\ 2 \end{pmatrix} \right\}$. So A is not diagonalizable.

12. The eigenvalues of A are 16, -2 , and -10 , with corresponding eigenvectors $\begin{pmatrix} 3 \\ 0 \\ 2 \end{pmatrix}$, $\begin{pmatrix} 0 \\ 1 \\ 0 \end{pmatrix}$, and $\begin{pmatrix} -2 \\ 0 \\ 3 \end{pmatrix}$.

$$\text{Hence, } Q = \begin{pmatrix} 3/\sqrt{13} & 0 & -2/\sqrt{13} \\ 0 & 1 & 0 \\ 2/\sqrt{13} & 0 & 3/\sqrt{13} \end{pmatrix} \text{ and } Q^t A Q = \begin{pmatrix} 16 & 0 & 0 \\ 0 & -2 & 0 \\ 0 & 0 & -10 \end{pmatrix}.$$

13. A has eigenvalues 0, 4, and -3 , with $E_0 = \text{span} \left\{ \begin{pmatrix} 1 \\ 1 \\ 0 \end{pmatrix} \right\}$, $E_4 = \text{span} \left\{ \begin{pmatrix} 1 \\ 1 \\ 0 \end{pmatrix} \right\}$, and $E_{-3} =$

$$\text{span} \left\{ \begin{pmatrix} 0 \\ 0 \\ 1 \end{pmatrix} \right\}. \text{ Thus } Q = \begin{pmatrix} -1/\sqrt{2} & 1/\sqrt{2} & 0 \\ 1/\sqrt{2} & 1/\sqrt{2} & 0 \\ 0 & 0 & 1 \end{pmatrix} \text{ and } Q^t A Q = \begin{pmatrix} 0 & 0 & 0 \\ 0 & 4 & 0 \\ 0 & 0 & -3 \end{pmatrix}.$$

14. The eigenvalues of A are 2, 4, and 6, with $E_2 = \text{span} \left\{ \begin{pmatrix} -1 \\ 1 \\ 0 \\ 0 \end{pmatrix}, \begin{pmatrix} 0 \\ 0 \\ 1 \\ 1 \end{pmatrix} \right\}$, $E_4 = \text{span} \left\{ \begin{pmatrix} 0 \\ -1 \\ 0 \\ 1 \end{pmatrix} \right\}$,

$$\text{and } E_6 = \text{span} \left\{ \begin{pmatrix} 1 \\ 0 \\ 0 \\ 1 \end{pmatrix} \right\}. \text{ So } C = \begin{pmatrix} -1 & 0 & 0 & 1 \\ 1 & 0 & -1 & 0 \\ 0 & 1 & 0 & 0 \\ 0 & 1 & 1 & 1 \end{pmatrix} \text{ and } C^{-1} A C = \begin{pmatrix} 2 & 0 & 0 & 0 \\ 0 & 2 & 0 & 0 \\ 0 & 0 & 4 & 0 \\ 0 & 0 & 0 & 6 \end{pmatrix}.$$

15. A has 3 and -1 as eigenvalues, with $E_3 = \text{span} \left\{ \begin{pmatrix} 1 \\ 0 \\ 0 \\ 0 \end{pmatrix}, \begin{pmatrix} 0 \\ 0 \\ 0 \\ 1 \end{pmatrix} \right\}$ and $E_{-1} = \text{span} \left\{ \begin{pmatrix} 0 \\ 1 \\ 1 \\ 0 \end{pmatrix}, \begin{pmatrix} -1 \\ 1 \\ 0 \\ 1 \end{pmatrix} \right\}$.

$$\text{Hence } C = \begin{pmatrix} 1 & 0 & 0 & -1 \\ 0 & 0 & 1 & 1 \\ 0 & 0 & 1 & 0 \\ 0 & 1 & 0 & 1 \end{pmatrix} \text{ and } C^{-1} A C = \begin{pmatrix} 3 & 0 & 0 & 0 \\ 0 & 3 & 0 & 0 \\ 0 & 0 & -1 & 0 \\ 0 & 0 & 0 & -1 \end{pmatrix}.$$

16. We have $A = \begin{pmatrix} 0 & 1/2 \\ 1/2 & 0 \end{pmatrix}$. The eigenvalues of A are $1/2$ and $-1/2$, with corresponding eigenvectors

$$\begin{pmatrix} 1 \\ 1 \end{pmatrix} \text{ and } \begin{pmatrix} 1 \\ -1 \end{pmatrix}. \text{ Hence, with } \begin{pmatrix} x' \\ y' \end{pmatrix} = \begin{pmatrix} 1/\sqrt{2} & 1/\sqrt{2} \\ -1/\sqrt{2} & 1/\sqrt{2} \end{pmatrix} \begin{pmatrix} x \\ y \end{pmatrix}, \text{ then we have } \frac{x'^2}{8} - \frac{y'^2}{8} = 1, \text{ which is an equation of a hyperbola.}$$

17. As $A = \begin{pmatrix} 4 & 1 \\ 1 & 2 \end{pmatrix}$, A has $3 + \sqrt{2}$ and $3 - \sqrt{2}$ as eigenvalues, with corresponding eigenvectors $\begin{pmatrix} 1 + \sqrt{2} \\ 1 \end{pmatrix}$ and $\begin{pmatrix} 1 - \sqrt{2} \\ 1 \end{pmatrix}$. Thus, with $\begin{pmatrix} x' \\ y' \end{pmatrix} = \begin{pmatrix} (1 + \sqrt{2})/\alpha & (1 - \sqrt{2})/\beta \\ 1/\alpha & 1/\beta \end{pmatrix} \begin{pmatrix} x \\ y \end{pmatrix}$, where $\alpha = \sqrt{4 + 2\sqrt{2}}$ and $\beta = \sqrt{4 - 2\sqrt{2}}$, then $\frac{x'^2}{8/(3 + \sqrt{2})} + \frac{y'^2}{8/(3 - \sqrt{2})} = 1$, which is an equation of an ellipse.
18. As $A = \begin{pmatrix} 4 & -3/2 \\ -3/2 & 1 \end{pmatrix}$, A has $(5 + 3\sqrt{2})/2$ and $(5 - 3\sqrt{2})/2$ as eigenvalues, with $\begin{pmatrix} 1 - \sqrt{2} \\ 1 \end{pmatrix}$ and $\begin{pmatrix} 1 + \sqrt{2} \\ 1 \end{pmatrix}$ as corresponding eigenvectors. Let $\alpha = \sqrt{4 - 2\sqrt{2}}$ and $\beta = \sqrt{4 + 2\sqrt{2}}$. Hence, with $\begin{pmatrix} x' \\ y' \end{pmatrix} = \begin{pmatrix} 1/\alpha & 1/\beta \\ (1 - \sqrt{2})/\alpha & (1 + \sqrt{2})/\beta \end{pmatrix} \begin{pmatrix} x \\ y \end{pmatrix}$, then $\frac{x'^2}{2/(5 + 3\sqrt{5})} + \frac{y'^2}{2/(5 - 3\sqrt{5})} = 1$, which is an equation of an ellipse.
19. As $A = \begin{pmatrix} 0 & -1 \\ -1 & 3 \end{pmatrix}$, A has $(3 + \sqrt{13})/2$ and $(3 - \sqrt{13})/2$ as eigenvalues, with corresponding eigenvectors $\begin{pmatrix} -2 \\ 3 + \sqrt{13} \end{pmatrix}$ and $\begin{pmatrix} -2 \\ 3 - \sqrt{13} \end{pmatrix}$. Let $\alpha = \sqrt{26 + 6\sqrt{13}}$ and $\beta = \sqrt{26 - 6\sqrt{13}}$. With $\begin{pmatrix} x' \\ y' \end{pmatrix} = \begin{pmatrix} -2/\alpha & -2/\beta \\ (3 + \sqrt{13})/\alpha & (3 - \sqrt{13})/\beta \end{pmatrix} \begin{pmatrix} x \\ y \end{pmatrix}$, then $\frac{x^2}{10/(3 + \sqrt{13})} + \frac{y^2}{10/(3 - \sqrt{13})} = 1$, which is an equation of a hyperbola.
20. We have $A = \begin{pmatrix} 1 & -2 \\ -2 & 4 \end{pmatrix}$. The matrix has 0 and 5 as eigenvalues, with $\begin{pmatrix} 2 \\ 1 \end{pmatrix}$ and $\begin{pmatrix} 1 \\ -2 \end{pmatrix}$ as corresponding eigenvectors. Let $\begin{pmatrix} x' \\ y' \end{pmatrix} = \frac{1}{\sqrt{5}} \begin{pmatrix} 1 & 2 \\ -2 & 1 \end{pmatrix} \begin{pmatrix} x \\ y \end{pmatrix}$, then $5x'^2 = -1$, which is a degenerate conic section.
21. $A = \begin{pmatrix} 2 & 2 & 0 \\ 2 & 2 & 0 \\ 0 & 0 & -3 \end{pmatrix}$ has 0, 4, and -3 as eigenvalues, with $\begin{pmatrix} 1 \\ -1 \\ 0 \end{pmatrix}$, $\begin{pmatrix} 1 \\ 1 \\ 0 \end{pmatrix}$, and $\begin{pmatrix} 0 \\ 0 \\ 1 \end{pmatrix}$ as corresponding eigenvectors. Let $\begin{pmatrix} x' \\ y' \\ z' \end{pmatrix} = \begin{pmatrix} 1/\sqrt{2} & 1/\sqrt{2} & 0 \\ -1/\sqrt{2} & 1/\sqrt{2} & 0 \\ 0 & 0 & 1 \end{pmatrix} \begin{pmatrix} x \\ y \\ z \end{pmatrix}$, then we have $4y'^2 - 3z'^2$.
22. The matrix A has 1 as an eigenvalue, with $E_1 = \text{span} \left\{ \begin{pmatrix} 2 \\ 5 \end{pmatrix} \right\}$. Solving $(A - I)\mathbf{v}_2 = \mathbf{v}_1$ for \mathbf{v}_2 , we obtain $\mathbf{v}_2 = \begin{pmatrix} -1 \\ -2 \end{pmatrix}$, and hence, $C = \begin{pmatrix} 2 & -1 \\ 5 & -2 \end{pmatrix}$ and $J = \begin{pmatrix} 1 & 1 \\ 0 & 1 \end{pmatrix}$.
23. The matrix A has -2 as an eigenvalue, with $E_{-2} = \text{span} \left\{ \begin{pmatrix} 2 \\ 1 \end{pmatrix} \right\}$. Upon solving $(A + 2I)\mathbf{v}_2 = \mathbf{v}_1$, we obtain $\mathbf{v}_2 = \begin{pmatrix} -1 \\ 0 \end{pmatrix}$. So $C = \begin{pmatrix} 2 & -1 \\ 1 & 0 \end{pmatrix}$ and $J = \begin{pmatrix} -2 & 1 \\ 0 & -2 \end{pmatrix}$.

24. The matrix A has -1 as an eigenvalue, with $E_1 = \text{span} \left\{ \begin{pmatrix} -5 \\ -3 \\ 7 \end{pmatrix} \right\}$. Upon solving $(A + I)\mathbf{v}_2 = \mathbf{v}_1$

and $(A + I)\mathbf{v}_3 = \mathbf{v}_2$, we obtain $\mathbf{v}_2 = \begin{pmatrix} -2 \\ -1 \\ 3 \end{pmatrix}$ and $\mathbf{v}_3 = \begin{pmatrix} 2 \\ 1 \\ -2 \end{pmatrix}$. Then $C = \begin{pmatrix} -5 & -2 & 2 \\ -3 & -1 & 1 \\ 7 & 3 & -2 \end{pmatrix}$ and

$$J = \begin{pmatrix} -1 & 1 & 0 \\ 0 & -1 & 1 \\ 0 & 0 & -1 \end{pmatrix}.$$

25. The eigenvalues of A are 1 and -1 , with $\begin{pmatrix} 1 \\ 1 \end{pmatrix}$ and $\begin{pmatrix} 2 \\ 1 \end{pmatrix}$ as corresponding eigenvectors. With $C =$

$$\begin{pmatrix} 1 & 2 \\ 1 & 1 \end{pmatrix} \text{ and } J = \begin{pmatrix} 1 & 0 \\ 0 & -1 \end{pmatrix}, \text{ then } e^{At} = Ce^{Jt}C^{-1} = \begin{pmatrix} 1 & 2 \\ 1 & 1 \end{pmatrix} \begin{pmatrix} e^t & 0 \\ 0 & e^{-t} \end{pmatrix} \begin{pmatrix} -1 & 2 \\ 1 & -1 \end{pmatrix} = \\ \begin{pmatrix} -e^t + 2e^{-t} & 2e^t - 2e^{-t} \\ -e^t + e^{-t} & 2e^t - e^{-t} \end{pmatrix}.$$

26. From problem 23, we have that $C = \begin{pmatrix} 2 & -1 \\ 1 & 0 \end{pmatrix}$ and $J = \begin{pmatrix} -2 & 1 \\ 0 & -2 \end{pmatrix}$. So $e^{At} = Ce^{Jt}C^{-1} =$

$$\begin{pmatrix} 2 & -1 \\ 1 & 0 \end{pmatrix} \begin{pmatrix} e^{-2t} & te^{-2t} \\ 0 & e^{-2t} \end{pmatrix} \begin{pmatrix} 0 & 1 \\ -1 & 2 \end{pmatrix} = e^{-2t} \begin{pmatrix} 1 - 2t & 4t \\ -t & 1 + 2t \end{pmatrix}.$$

27. The eigenvalues of the matrix are $-1 + 2i$ and $-1 - 2i$, with corresponding eigenvectors $\begin{pmatrix} 2 \\ -1 - i \end{pmatrix}$

and $\begin{pmatrix} 2 \\ -1 + i \end{pmatrix}$. With $C = \begin{pmatrix} 2 & 2 \\ -1 - i & -1 + i \end{pmatrix}$ and $J = \begin{pmatrix} -1 + 2i & 0 \\ 0 & -1 - 2i \end{pmatrix}$, then $e^{At} = CJC^{-1} =$
 $e^{-t} \begin{pmatrix} \cos 2t - \sin 2t & -2 \sin 2t \\ \sin 2t & \cos 2t + \sin 2t \end{pmatrix}.$

28. As $p(A) = A^3 - 7A^2 + 19A - 23I$, then

$$\begin{aligned} A^{-1} &= \frac{-1}{23}(-A^2 + 7A - 19I) \\ &= \frac{-1}{23} \left[- \begin{pmatrix} -1 & 8 & 6 \\ -3 & -2 & -1 \\ -11 & -11 & 14 \end{pmatrix} + 7 \begin{pmatrix} 2 & 3 & 1 \\ -1 & 1 & 0 \\ -2 & -1 & 4 \end{pmatrix} - 19 \begin{pmatrix} 1 & 0 & 0 \\ 0 & 1 & 0 \\ 0 & 0 & 1 \end{pmatrix} \right] \\ &= \frac{1}{23} \begin{pmatrix} 4 & -13 & -1 \\ 4 & 10 & -1 \\ 3 & -4 & 5 \end{pmatrix}. \end{aligned}$$

29. We have $|\lambda - 3| \leq 1/2 + 1/2 = 1$, $|\lambda - 4| \leq 1/3 + 1/3 = 2/3$, $|\lambda - 2| \leq 1 + 1 = 2$, and $|\lambda + 3| \leq 1/2 + 1/2 + 1 = 2$. Hence $|\lambda| \leq 5$ and $-5 \leq \text{Re } \lambda \leq 14/3$.

Appendix 1. Mathematical Induction

1. For $n = 1$, the equation holds. Assume that the equation holds for $n = k$. Then $2 + 4 + \cdots + 2k + 2(k + 1) = k(k + 1) + 2(k + 1) = (k + 1)(k + 2)$, which completes the proof.
2. For $n = 1$, the formula holds. Assume the equation holds for $n = k$. Then $1 + 4 + 7 + \cdots + (3k - 2) + [3(k + 1) - 2] = \frac{k(3k - 1)}{2} + 3k + 1 = \frac{3k^2 + 5k + 2}{2} = \frac{(k + 1)(3k + 2)}{2} = \frac{(k + 1)[3(k + 1) - 1]}{2}$.
3. For $n = 1$, the equation holds. Assume the formula holds for $n = k$. Then $2 + 5 + 8 + \cdots + [3(k + 1) - 1] = \frac{k(3k + 1)}{2} + 3k + 2 = \frac{3k^2 + 7k + 4}{2} = \frac{(k + 1)(3k + 4)}{2} = \frac{(k + 1)[3(k + 1) + 1]}{2}$.
4. As the equation holds for $n = 1$, we assume that it holds for $n = k$. Then $1 + 3 + 5 + \cdots + (2k - 1) + [3(k + 1) - 1] = k^2 + 2k + 1 = (k + 1)^2$.
5. $(\frac{1}{2})^1 = \frac{1}{2} < \frac{1}{1} = 1$, so inequality is true for $n = 1$. Now assume it is true for $n = k$. That is, $(\frac{1}{2})^k < \frac{1}{k}$. Then $(\frac{1}{2})^{k+1} = \frac{1}{2}(\frac{1}{2})^k < \frac{1}{2}(\frac{1}{k}) = \frac{1}{2k} < \frac{1}{k+1}$ since $2k > k + 1$ if $k > 1$.
6. As the inequality holds for $n = 4$, assume that it holds for $n = k$. Then $2^{k+1} = 2 \cdot 2^k < 2 \cdot n! \leq (k + 1)k! = (k + 1)!$.
7. The formula holds for $k = 1$. Assume that the formula holds for $n = k$. Then $1 + 2 + 4 + \cdots + 2^{k+1} = 2^{k+1} - 1 + 2^{k+1} = 2^{k+2} - 1$.
8. The equation holds for $n = 1$. Suppose that the equation holds for $n = k$. Then $1 + 3 + 9 + \cdots + 3^{k+1} = \frac{3^{k+1} - 1}{2} + 3^{k+1} = \frac{3^{k+2} - 1}{2}$.
9. As the equation holds for $n = 1$, assume that it holds for $n = k$. Then $1 + \frac{1}{2} + \frac{1}{2^2} + \cdots + \frac{1}{2^{k+1}} = 2 - \frac{1}{2^k} + \frac{1}{2^{k+1}} = 2 - \frac{1}{2^{k+1}}$.
10. For $n = 1$, we have $1 = 1$. Now assume that the equation holds for $n = k$. Then $1 - \frac{1}{3} + \frac{1}{9} - \cdots + \left(-\frac{1}{3}\right)^{k+1} = \frac{3}{4} \left[1 - \left(-\frac{1}{3}\right)^{k+1}\right] + \left(-\frac{1}{3}\right)^{k+1} = \frac{3}{4} \left[1 - \left(-\frac{1}{3}\right)^{k+2}\right]$.
11. For $n = 1$, we have $1 = 1$. Suppose that the formula holds for $n = k$. Then $1^3 + 2^3 + \cdots + (k + 1)^3 = \frac{k^2(k + 1)^2}{4} + (k + 1)^3 = \frac{(k + 1)^2(k + 2)^2}{4}$.
12. As the equation holds for $n = 1$, assume that it holds for $n = k$. Then $1 \cdot 2 + 2 \cdot 3 + \cdots + (k + 1)(k + 2) = \frac{k(k + 1)(k + 2)}{3} + (k + 1)(k + 2) = \frac{(k + 1)(k + 2)(k + 3)}{3}$.
13. For $n = 1$, we have $2 = 2$. Suppose that the equation holds for $n = k$. Then $1 \cdot 2 + 3 \cdot 4 + \cdots + [2(k + 1) - 1][2(k + 1)] = \frac{k(k + 1)(4k - 1)}{3} + 2(2k + 1)(k + 1) = \frac{(k + 1)(k + 2)(4k + 3)}{3}$.

14. For $n = 1$ the equation holds. So suppose that the equation holds for $n = k$. Then

$$\begin{aligned} \frac{1}{2^2-1} + \frac{1}{3^2-1} + \cdots + \frac{1}{(k+2)^2-1} &= \frac{3}{4} - \frac{1}{2(k+1)} - \frac{1}{2(k+2)} + \frac{1}{k^2+4k+1} \\ &= \frac{3}{4} - \frac{1}{2(k+2)} - \frac{1}{2(k+3)} \end{aligned}$$

15. When $n = 1$, $n^2 + n = 2$, which is even. Now suppose that $k^2 + k$ is even. Then $(k+1)^2 + (k+1) = k^2 + 3k + 2 = k^2 + k + 2(k+1)$, which is even.

16. For $n = 12$, the inequality holds. Suppose that the inequality holds for $n = k$, $k > 11$. Then $k+1 < \frac{k^2 - k}{10} + 2 + 1 = \frac{(k+1)^2 - 3k - 1}{10} + 3 = \frac{(k+1)^2 - 3k + 9}{10} + 2 < \frac{(k+1)^2 - (k+1)}{10} + 2$ (since $3k - 9 > k + 1$).

17. If $n = 1$, then $n(n^2 + 5) = 6$. Suppose 6 divides $k(k^2 + 5)$. Then $(k+1)[(k+1)^2 + 5] = (k+1)[(k^2 + 5) + (2k+1)] = k(k^2 + 5) + 3(k^2 + k + 2)$. Using problem 15, we see that 6 divides $(k+1)[(k+1)^2 + 5]$.

18. For $n = 1$, $3n^5 + 5n^3 + 7n = 15$. Suppose 15 divides $3k^5 + 5k^3 + 7k$. Then $3(k+1)^5 + 5(k+1)^3 + 7(k+1) = 3k^5 + 15k^4 + 35k^3 + 45k^2 + 37k + 15 = (3k^5 + 5k^3 + 7k) + (15k^4 + 30k^3 + 45k^2 + 30k + 15)$, which is divisible by 15.

19. We will show that $(x-1)(1+x+x^2+\cdots+x^{n-1}) = x^n - 1$. For $n = 1$, we have equality, so suppose the equation holds for $n = k$. Then $(x-1)(1+x+x^2+\cdots+x^k) = x^k - 1 + (x-1)x^k = x^{k+1} - 1$. Thus $x^n - 1$ is divisible by $x - 1$.

20. We will show $(x-y) \sum_{i=0}^{n-1} x^i y^{n-i-1} = x^n - y^n$. For $n = 1$, we have equality, so suppose the equation holds for $n = k - 1$. Then

$$\begin{aligned} (x-y) \sum_{i=0}^k x^i y^{k-i} &= (x-y)x^k + (x-y) \sum_{i=0}^{k-1} x^i y^{k-i} \\ &= (x-y)x^k + (x-y)y \sum_{i=0}^{k-1} x^i y^{k-1-i} \\ &= (x-y)x^k + y(x^k - y^k) \quad \text{by induction} \\ &= x^{k+1} - y^{k+1}. \end{aligned}$$

21. If $n = 1$, then $(ab)^1 = ab$. Now suppose that $(ab)^k = a^k b^k$. Then $(ab)^{k+1} = (ab)(ab)^k = (ab)(a^k b^k) = a a^k b b^k = a^{k+1} b^{k+1}$.

22. Proof by induction on n . Let f be a polynomial of degree 1, i.e. $f(x) = ax + b$, $a \neq 0$. Then $ax + b = 0$ implies $x = -b/a$. Therefore f has exactly one root. This proves the desired proposition for $n = 1$.

Now suppose that it is true for $n = k$. Let g be a polynomial of degree $k + 1$. g has at least one complex root, so let α be a root of g . Then $g(x) = (x - \alpha)h(x)$ by division where h is a polynomial of degree k . $h(x)$ has exactly k roots by the induction hypothesis so $g(x)$ has exactly $k + 1$ roots since $g(x) = 0$ only if $(x - \alpha) = 0$ or $h(x) = 0$. This completes the proof.

23. Suppose $\det(A_1 A_2 \cdots A_{m-1}) = \det A_1 \det A_2 \cdots \det A_{m-1}$. Then

$$\det(A_1 A_2 \cdots A_m) = \det(A_1 A_2 \cdots A_{m-1}) \det(A_m) = \det A_1 \det A_2 \cdots \det A_m.$$

24. Suppose $(A_1 + A_2 + \cdots + A_{k-1})^t = A_1^t + A_2^t + \cdots + A_{k-1}^t$. Then $(A_1 + A_2 + \cdots + A_k)^t = (A_1 + A_2 + \cdots + A_{k-1})^t + A_k^t = A_1^t + A_2^t + \cdots + A_k^t$.
25. If S is a set with 0 elements, then S is the empty set. The proposition states that S must have exactly $2^0 = 1$ subset. But the empty set does have exactly one subset, namely, the empty set itself. So suppose that sets with k elements have exactly 2^k subsets. Let $S = \{x_1, x_2, \dots, x_{k+1}\}$ be any set of size $k + 1$. Then we may classify all subsets of S into two groups: those subsets which contain x_{k+1} and those that do not. Note that the number of subsets of S that contain x_{k+1} is the same as the number of subsets that do not contain x_{k+1} . Now, the subsets of S that do not contain x_{k+1} are precisely the subsets of $T = \{x_1, x_2, \dots, x_k\}$. By hypothesis, T has exactly 2^k subsets. Hence there are $2 \cdot 2^k = 2^{k+1}$ subsets of S .
26. Suppose $2k - 1$ is even. Since 2 divides $(2k - 1) + 2$, then $2(k + 1) - 1$ is even. To conclude something by induction, we would need to show that $2k - 1$ is even for some integer k . But $2k - 1$ is odd.
27. For the induction step to be valid, the intersection of S_1 and S_2 would have to be nonempty to link the two sets of equalities. But if $k = 2$, $S_1 \cap S_2$ is empty.

Appendix 2. Complex Numbers

1. $(2 - 3i) + (7 - 4i) = 9 - 7i$
 2. $3(4 + i) - 5(-3 + 6i) = 12 + 3i + 15 - 30i = 27 - 27i$
 3. $(1 + i)(1 - i) = 2$
 4. $(2 - 3i)(4 + 7i) = 29 + 2i$
 5. $(-3 + 2i)(7 + 3i) = -27 + 5i$
 6. $5i = 5e^{\pi i/2}$
 7. $5 + 5i = 5\sqrt{2} \cdot e^{\pi i/4}$
 8. $-2 - 2i = 2\sqrt{2} \cdot e^{-3\pi i/4}$
 9. $3 - 3i = 3\sqrt{2} \cdot e^{-\pi i/4}$
 10. $2 + 2\sqrt{3}i = 4e^{\pi i/3}$
 11. $3\sqrt{3} + 3i = 6e^{\pi i/6}$
 12. $1 - \sqrt{3}i = 2e^{-\pi i/3}$
 13. $4\sqrt{3} - 4i = 8e^{-\pi i/6}$
 14. $-6\sqrt{3} - 6i = 12e^{-5\pi i/6}$
 15. $-1 - \sqrt{3}i = 2e^{-2\pi i/3}$
 16. $e^{3\pi i} = -1$
 17. $2e^{-7\pi i} = -2$
 18. $(e^{3\pi i/4})/2 = -\sqrt{2}/4 + \sqrt{2}i/4$
 19. $(e^{-3\pi i/4})/2 = -\sqrt{2}/4 - \sqrt{2}i/4$
 20. $6e^{\pi i/6} = 3\sqrt{3} + 3i$
 21. $4e^{5\pi i/6} = -2\sqrt{3} + 2i$
 22. $4e^{-5\pi i/6} = -2\sqrt{3} - 2i$
 23. $3e^{-2\pi i/3} = -3/2 - 3\sqrt{3}i/2$
 24. $\sqrt{3}e^{23\pi i/4} = \sqrt{6}/2 - \sqrt{6}i/2$
 25. $e^i = 0.5403 + 0.8415i$
 26. $3 + 4i$
 27. $4 - 6i$
 28. $-3 - 8i$
 29. $7i$
 30. 16
 31. $2e^{-\pi i/7}$
 32. $4e^{-3\pi i/5}$
 33. $3e^{4\pi i/11}$
 34. $e^{-0.012i}$
35. Suppose $z = \alpha + i\beta$ is real. Then $\beta = 0$. Then $z = \alpha = \bar{z}$. Next, suppose $z = \bar{z}$. Then $a + i\beta = \alpha - i\beta$. Then $i\beta = -i\beta \Rightarrow \beta = -\beta \Rightarrow \beta = 0$. Then z is real.
36. Suppose $z = \alpha + i\beta$ is pure imaginary. Then $\alpha = 0$. Then $\bar{z} = -i\beta = -z$. Next, suppose $z = -\bar{z}$. Then $\alpha + i\beta = -\alpha + i\beta$. Then $\alpha = -\alpha \Rightarrow \alpha = 0$. Then z is pure imaginary.
37. Let $z = \alpha + i\beta$. Then $z\bar{z} = (\alpha + i\beta)(\alpha - i\beta) = \alpha^2 + \beta^2 = |z|^2$.
38. The unit circle $(x, y) : x^2 + y^2 = 1$. As complex numbers, the unit circle $= \{z = x + iy : x^2 + y^2 = 1\}$. But $x^2 + y^2 = |z|^2 = 1 \Rightarrow |z| = 1$. Thus the unit circle is the set of points in the complex plane that satisfies $|z| = 1$.
39. The circle of radius a centered at z_0 .
40. The circle and interior of the circle of radius a centered at z_0 .
41. First note that $(\bar{z})^n = \overline{z^n}$. Then $p(\bar{z}) = \overline{p(z)}$, since coefficients are real. So if $p(z) = 0$, then $p(\bar{z}) = \bar{0} = 0$.
42. $\cos 4\theta + i \sin 4\theta = (\cos \theta + i \sin \theta)^4$
 $= (\cos^4 \theta + \sin^4 \theta - 6 \cos^2 \theta \sin^2 \theta) + (4 \cos^3 \theta \sin \theta - 4 \cos \theta \sin^3 \theta)i$
 Then $\cos 4\theta = \cos^4 \theta + \sin^4 \theta - 6 \cos^2 \theta \sin^2 \theta = 1 - 8 \cos^2 \theta \sin^2 \theta$ and $\sin 4\theta = 4 \cos^3 \theta \sin \theta - 4 \cos \theta \sin^3 \theta$.
43. For $n = 1$, $(\cos \theta + i \sin \theta)^1 = \cos \theta + i \sin \theta$. Thus DeMoivre's formula is true for $n = 1$. Suppose it is true for $n = k$, that is, $(\cos \theta + i \sin \theta)^k = \cos(k\theta) + i \sin(k\theta)$. Then consider $n = k + 1$.

$$\begin{aligned}
 (\cos \theta + i \sin \theta)^{k+1} &= (\cos \theta + i \sin \theta)^k (\cos \theta + i \sin \theta) \\
 &= (\cos(k\theta) + i \sin(k\theta))(\cos \theta + i \sin \theta) \\
 &= (\cos(k\theta) \cos \theta - \sin(k\theta) \sin \theta) + (\cos(k\theta) \sin \theta + \sin(k\theta) \cos \theta)i \\
 &= \cos((k+1)\theta) + i \sin((k+1)\theta)
 \end{aligned}$$

Thus DeMoivre's formula holds for $n = 1, 2, \dots$

Appendix 3. The Error in Numerical Computations and Computational Complexity

- | | | |
|-------------------------------|------------------------------|------------------------------|
| 1. 0.33333333×10^0 | 2. 0.875×10^0 | 3. -0.35×10^{-4} |
| 4. 0.77777778×10^0 | 5. 0.77777777×10^0 | 6. 0.47142857×10^1 |
| 7. 0.77272727×10^1 | 8. -0.18833333×10^2 | 9. -0.18833333×10^2 |
| 10. 0.23705962×10^9 | 11. 0.23705963×10^9 | 12. -0.237×10^{17} |
| 13. 0.83742×10^{-20} | | |

14. $\epsilon_a = |0.49 \times 10^1 - 5| = 0.1$; $\epsilon_r = 0.1/5 = 0.02$
 15. $\epsilon_a = |0.4999 \times 10^3 - 500| = 0.1$; $\epsilon_r = 0.1/500 = 0.0002$
 16. $\epsilon_a = |0.3704 \times 10^4 - 3720| = 16$; $\epsilon_r = 16/3720 = 0.0043$
 17. $\epsilon_a = |0.12 \times 10^0 - 1/8| = 0.005$; $\epsilon_r = 0.005 \cdot 8 = 0.04$
 18. $\epsilon_a = |0.12 \times 10^{-2} - 1/800| = 0.00005$; $\epsilon_r = 0.00005 \cdot 800 = 0.04$
 19. $\epsilon_a = |-0.583 \times 10^1 + 5\frac{5}{8}| = 0.0033333 \dots$; $\epsilon_r \approx 0.57143 \times 10^{-3}$
 20. $\epsilon_a = |0.70466 \times 10^0 - 0.70465| = 0.1 \times 10^{-4}$; $\epsilon_r = 0.70465 \times 10^{-5}$
 21. $\epsilon_a = |0.70466 \times 10^5 - 70465| = 1$; $\epsilon_a \approx 0.1419144 \times 10^{-4}$

22. There are three different operations: (1) divide row i by a_{ii} in columns $i+1$ to $n+1$, (2) multiply row i by a_{ji} in columns $i+1$ to $n+1$, and subtract it from row j for $j > i$; (3) multiply b_i by a_{ji} , $j < i$, and

subtract it from b_j . Operation (1) requires $\sum_{k=1}^n k = \frac{n(n+1)}{2}$ multiplications, $k = n+1-i$. Operation

(2) requires $\sum_{k=1}^{n-1} k(k+1) = \sum_{k=1}^{n-1} k^2 + \sum_{k=1}^{n-1} k = \frac{(n-1)n(2n-1)}{6} + \frac{(n-1)n}{2} = \frac{n^3-n}{3}$ multiplications

and additions. Operation (3) requires $\sum_{k=1}^{n-1} k = \frac{n^2-n}{2}$ multiplications and additions. Adding these

fractions together gives the formulas in row 2 of Table 1.

23. There are three operations: (1) dividing row i by a_{ii} in columns $i+1$ to $n+1$, (2) multiplying row i by a_{ji} in columns $i+1$ to $n+1$ and subtracting it from row j for $j > i$, (3) the back substitution. Op-

eration (1) requires $\sum_{k=1}^n k = \frac{n(n+1)}{2}$ multiplications. Operation (2) requires $\sum_{k=1}^{n-1} k(k+1) = \frac{n^3-n}{3}$

multiplications and additions. Operation (3) requires $\sum_{k=1}^{n-1} k = \frac{n^2-n}{2}$ multiplications and additions.

Adding these fractions together gives the desired results.

24. Let $(A|I) = (b_{ij})$. At the k^{th} step, we divide b_{kj} by b_{kk} for $k+1 \leq j \leq n+k$ as the rest of row k is zero, and then multiply b_{kj} by a_{ik} , for $i \neq k$. This gives $n+n(n-1) = n^2$ multiplications at each step. As there are n steps, then there are n^3 total multiplications. As for the number of additions, note that at each step k , we perform $(n-k)(n-1) + (k-1)(n-1)$ additions. Hence, there are

$$\sum_{k=1}^{n-1} (n-k)(n-1) + \sum_{k=2}^n (k-1)(n-1) = (n-1) \sum_{k=1}^n (n-1) = (n-1)^2 n = n^3 - 2n^2 + n$$

total additions and subtractions.

25. For the operation of dividing a row by a_{ii} in columns $i + 1$ to n , we have $n(n - 1)/2$ divisions. At each step k , $k = 1, 2, \dots, n - 1$, we multiply row k by a_{jk} in columns $k + 1$ to n , for $j > k$, and subtract it from row j . So this accounts for $\sum_{k=1}^{n-1} k^2 = \frac{n(n-1)(2n-1)}{6}$ additions and multiplications. Finally, keeping track of the diagonal elements and multiplying them together at the end requires $n-1$ multiplications. Adding these fractions gives $\frac{n^3}{3} + \frac{2n}{3} - 1$ multiplications and $\frac{n^3}{3} - \frac{n^2}{2} + \frac{n}{6}$ additions.
26. As it would require 4, 200 multiplications and 3, 990 additions, the average time would be $4, 200 \cdot (2 \times 10^{-6}) + 3, 990 \cdot (0.5 \times 10^{-6}) = 0.104$ seconds.
27. Since it would require 3, 060 multiplications and 2, 850 additions, the average time would be $3, 060 \cdot (2 \times 10^{-6}) + 2, 850 \cdot (0.5 \times 10^{-6}) = 7.545 \times 10^{-3}$ seconds.
28. 50×50 ; 0.31 seconds
 200×200 ; 19.96 seconds
 $10, 000 \times 10, 000$; 2.5×10^6 seconds
29. $AB = (c_{ij})$ where $c_{ij} = \sum_{k=1}^n a_{ik}b_{kj}$. As $i = 1, 2, \dots, m$ and $j = 1, 2, \dots, q$, there are $m \cdot q \cdot n$ multiplications and $m \cdot q \cdot (n - 1)$ additions.

Appendix 4. Gaussian Elimination with Pivoting

$$1. \left(\begin{array}{ccc|c} 2 & -1 & 1 & 0.3 \\ -4 & 3 & -2 & -1.4 \\ 3 & -8 & 3 & 0.1 \end{array} \right) \rightarrow \left(\begin{array}{ccc|c} -4 & 3 & -2 & -1.4 \\ 2 & -1 & 1 & 0.3 \\ 3 & -8 & 3 & 0.1 \end{array} \right) \rightarrow \left(\begin{array}{ccc|c} 1 & -0.75 & 0.5 & 0.35 \\ 0 & 0.5 & 0 & -0.4 \\ 0 & -5.75 & 1.5 & -0.95 \end{array} \right) \rightarrow \left(\begin{array}{ccc|c} 1 & -0.75 & 0.5 & 0.35 \\ 0 & -5.75 & 1.5 & -0.95 \\ 0 & 0.5 & 0 & -0.4 \end{array} \right) \rightarrow \left(\begin{array}{ccc|c} 1 & -0.75 & 0.5 & 0.35 \\ 0 & 1 & -0.260870 & 0.165217 \\ 0 & 0 & 0.130435 & -0.482609 \end{array} \right) \rightarrow \left(\begin{array}{ccc|c} 1 & -0.75 & 0.5 & 0.35 \\ 0 & 1 & -0.260870 & 0.165217 \\ 0 & 0 & 1 & -3.700000 \end{array} \right).$$

Then

$$\begin{aligned} x_3 &= -3.7 \\ x_2 &= 0.1653217 + 0.260870(-3.7) = -0.800002 \\ x_1 &= 0.35 + 0.75(-0.800002) - 0.5(-3.7) = 1.60000 \end{aligned}$$

$$2. \left(\begin{array}{ccc|c} 4.7 & 1.81 & 2.6 & -5.047 \\ -3.4 & -0.25 & 1.1 & 11.495 \\ 12.3 & 0.06 & 0.77 & 7.9684 \end{array} \right) \rightarrow \left(\begin{array}{ccc|c} 12.3 & 0.06 & 0.77 & 7.9684 \\ -3.4 & -0.25 & 1.1 & 11.495 \\ 4.7 & 1.81 & 2.6 & -5.047 \end{array} \right) \rightarrow \left(\begin{array}{ccc|c} 1 & 0.00487805 & 0.0626016 & 0.647837 \\ 0 & -0.233413 & 1.31285 & 13.6976 \\ 0 & 1.7807 & 2.30577 & 8.09183 \end{array} \right) \rightarrow \left(\begin{array}{ccc|c} 1 & 0.00487805 & 0.0626016 & 0.647837 \\ 0 & 1.7807 & 2.30577 & -8.09183 \\ 0 & -0.233413 & 1.31285 & 13.6976 \end{array} \right) \rightarrow \left(\begin{array}{ccc|c} 1 & 0.00487805 & 0.0626016 & 0.647837 \\ 0 & 1 & 1.29025 & -4.52799 \\ 0 & 0 & 1.61401 & 12.6407 \end{array} \right) \rightarrow \left(\begin{array}{ccc|c} 1 & 0.00487805 & 0.0626016 & 0.647837 \\ 0 & 1 & 1.29025 & -4.52799 \\ 0 & 0 & 1 & 7.83186 \end{array} \right).$$

Then

$$\begin{aligned} x_3 &= 7.83186 \\ x_2 &= -4.52799 - 1.29025(7.83186) = -14.6330 \\ x_1 &= 0.647837 - 0.00487805(-14.6330) - 0.0626016(7.83186) = 0.228931 \end{aligned}$$

$$3. \left(\begin{array}{ccc|c} -7.4 & 3.61 & 8.04 & 25.1499 \\ 12.16 & -2.7 & -0.891 & 3.2157 \\ -4.12 & 6.63 & -4.38 & -36.1383 \end{array} \right) \rightarrow \left(\begin{array}{ccc|c} 12.16 & -2.7 & -0.891 & 3.2157 \\ -7.4 & 3.61 & 8.04 & 25.1499 \\ -4.12 & 6.63 & -4.38 & -36.1383 \end{array} \right) \rightarrow \left(\begin{array}{ccc|c} 1 & -0.222039 & -0.073273 & 0.264449 \\ 0 & 1.96690 & 7.49778 & 27.1068 \\ 0 & 5.71520 & -4.68188 & -35.0488 \end{array} \right) \rightarrow \left(\begin{array}{ccc|c} 1 & -0.222039 & -0.073273 & 0.264449 \\ 0 & 5.715197 & -4.681885 & -35.048770 \\ 0 & 1.966908 & 7.497780 & 27.106823 \end{array} \right) \rightarrow \left(\begin{array}{ccc|c} 1 & -0.222039 & -0.073273 & 0.264449 \\ 0 & 1 & -0.819199 & -6.132556 \\ 0 & 0 & 9.109069 & 39.168996 \end{array} \right) \rightarrow \left(\begin{array}{ccc|c} 1 & -0.222039 & -0.073273 & 0.264449 \\ 0 & 1 & -0.819199 & -6.132556 \\ 0 & 0 & 1 & 4.300000 \end{array} \right).$$

Then

$$\begin{aligned} x_3 &= 4.3 \\ x_2 &= -6.132556 + 0.819199(4.30000) = -2.61 \\ x_1 &= 0.264449 + 0.222039(-2.61000) + 0.073273(4.3) = 0.0 \end{aligned}$$

$$\begin{aligned}
4. \quad & \left(\begin{array}{cccc|c} 4.1 & -0.7 & 8.3 & 3.9 & -4.22 \\ 2.6 & 8.1 & 0.64 & -0.8 & 37.452 \\ -5.3 & -0.2 & 7.4 & -0.55 & -25.73 \\ 0.8 & -1.3 & 3.6 & 1.6 & -7.7 \end{array} \right) \rightarrow \left(\begin{array}{cccc|c} -5.3 & -0.2 & 7.4 & -0.55 & -25.73 \\ 2.6 & 8.1 & 0.64 & -0.8 & 37.452 \\ 4.1 & -0.7 & 8.3 & 3.9 & -4.22 \\ 0.8 & -1.3 & 3.6 & 1.6 & -7.7 \end{array} \right) \\
& \rightarrow \left(\begin{array}{cccc|c} 1 & 0.377358 & -1.39623 & 0.103774 & 4.85472 \\ 0 & 8.00189 & 4.27020 & -1.06981 & 24.8297 \\ 0 & -0.8547168 & 14.0245 & 3.47453 & -24.1244 \\ 0 & -1.33019 & 4.71698 & 1.51698 & -11.5838 \end{array} \right) \rightarrow \left(\begin{array}{cccc|c} 1 & 0.377358 & -1.39623 & 0.103774 & 4.85472 \\ 0 & 1 & 0.533649 & -0.133695 & 3.10298 \\ 0 & 0 & 14.4806 & 3.36026 & -21.4722 \\ 0 & 0 & 5.42683 & 1.33914 & -7.45625 \end{array} \right) \\
& \rightarrow \left(\begin{array}{cccc|c} 1 & 0.377358 & -1.39623 & 0.103774 & 4.85472 \\ 0 & 1 & 0.533649 & -0.133695 & 3.10298 \\ 0 & 0 & 1 & 0.232053 & -1.48283 \\ 0 & 0 & 0 & 0.0798278 & 0.590816 \end{array} \right) \rightarrow \left(\begin{array}{cccc|c} 1 & 0.377358 & -1.39623 & 0.103774 & 4.85472 \\ 0 & 1 & 0.533649 & -0.133695 & 3.10298 \\ 0 & 0 & 1 & 0.232053 & -1.48283 \\ 0 & 0 & 0 & 1 & 7.40113 \end{array} \right)
\end{aligned}$$

Then $x_4 = 7.40113$

$$x_3 = -1.48283 - 0.232053(7.40113) = -3.20028$$

$$x_2 = 3.10298 - 0.533649(-3.20028) + 0.133695(7.40113) = 5.80030$$

$$x_1 = 4.85472 - 0.377358(5.80030) + 1.39623(-3.20028) - 0.103774(7.40113) = -2.57044$$

5. Gaussian elimination with partial pivoting:

$$\begin{aligned}
& \left(\begin{array}{ccc|c} 0.1 & 0.05 & 0.2 & 1.3 \\ 12 & 25 & -3 & 10 \\ -7 & 8 & 15 & 2 \end{array} \right) \rightarrow \left(\begin{array}{ccc|c} 12 & 12 & -3 & 10 \\ -7 & 8 & 15 & 2 \\ 0.1 & 0.05 & 0.2 & 1.3 \end{array} \right) \rightarrow \left(\begin{array}{ccc|c} 1 & 2.08 & -0.25 & 0.833 \\ 0 & 22.6 & 13.3 & 7.83 \\ 0 & -0.158 & 0.225 & 1.22 \end{array} \right) \\
& \rightarrow \left(\begin{array}{ccc|c} 1 & 2.08 & -0.25 & 0.833 \\ 0 & 1 & 0.588 & 0.346 \\ 0 & 0 & 0.318 & 1.27 \end{array} \right) \rightarrow \left(\begin{array}{ccc|c} 1 & 2.08 & -0.25 & 0.833 \\ 0 & 1 & 0.588 & 0.346 \\ 0 & 0 & 1 & 3.99 \end{array} \right). \text{ Then } x_3 = 3.99, x_2 = -2.00, x_1 = 5.99.
\end{aligned}$$

Gaussian elimination without partial pivoting:

$$\begin{aligned}
& \left(\begin{array}{ccc|c} 0.1 & 0.05 & 0.2 & 1.3 \\ 12 & 25 & -3 & 10 \\ -7 & 8 & 15 & 2 \end{array} \right) \rightarrow \left(\begin{array}{ccc|c} 1 & 0.5 & 2 & 13 \\ 0 & 19 & -27 & -146 \\ 0 & 11.5 & 29 & 93 \end{array} \right) \rightarrow \left(\begin{array}{ccc|c} 1 & 0.5 & 2 & 13 \\ 0 & 1 & -1.42 & -7.68 \\ 0 & 0 & 45.3 & 181 \end{array} \right) \\
& \rightarrow \left(\begin{array}{ccc|c} 1 & 0.5 & 2 & 13 \\ 0 & 1 & -1.42 & -7.68 \\ 0 & 0 & 1 & 4.00 \end{array} \right). \text{ Then } x_3 = 4.00, x_2 = -2.00, x_1 = 6.00.
\end{aligned}$$

Exact solution: $x_1 = 6$, $x_2 = -1$, $x_3 = 4$.

Relative error with partial pivoting: $x_1 : 0.00167$, $x_2 : 0$, $x_3 : 0.0025$

Relative error without partial pivoting: $x_1 : 0$, $x_2 : 0$, $x_3 : 0$.

6. Gaussian elimination with partial pivoting:

$$\begin{aligned}
& \left(\begin{array}{ccc|c} 0.02 & 0.03 & -0.04 & -0.04 \\ 16 & 2 & 4 & 0 \\ 50 & 10 & 8 & 6 \end{array} \right) \rightarrow \left(\begin{array}{ccc|c} 50 & 10 & 8 & 6 \\ 16 & 2 & 4 & 0 \\ 0.02 & 0.03 & -0.04 & -0.04 \end{array} \right) \rightarrow \left(\begin{array}{ccc|c} 1 & 0.2 & 0.16 & 0.12 \\ 0 & -1.2 & 1.44 & -1.92 \\ 0 & 0.026 & -0.0432 & -0.0424 \end{array} \right) \\
& \rightarrow \left(\begin{array}{ccc|c} 1 & 0.2 & 0.16 & 0.12 \\ 0 & 1 & -1.2 & 1.6 \\ 0 & 0 & -0.012 & -0.0424 \end{array} \right) \rightarrow \left(\begin{array}{ccc|c} 1 & 0.2 & 0.16 & 0.12 \\ 0 & 1 & -1.2 & 1.6 \\ 0 & 0 & 1 & 7 \end{array} \right). \text{ Then } x_3 = 7, x_2 = 10, x_1 = -3.
\end{aligned}$$

Gaussian elimination without partial pivoting:

$$\begin{aligned}
& \left(\begin{array}{ccc|c} 0.02 & 0.03 & -0.04 & -0.04 \\ 16 & 2 & 4 & 0 \\ 50 & 10 & 8 & 6 \end{array} \right) \rightarrow \left(\begin{array}{ccc|c} 1 & 1.5 & -2 & -2 \\ 0 & -22 & 36 & 32 \\ 0 & -65 & 108 & 106 \end{array} \right) \rightarrow \left(\begin{array}{ccc|c} 1 & 1.5 & -2 & -2 \\ 0 & 1 & -1.64 & -1.45 \\ 0 & 0 & 1.4 & 11.8 \end{array} \right) \\
& \rightarrow \left(\begin{array}{ccc|c} 1 & 1.5 & -2 & -2 \\ 0 & 1 & -1.64 & -1.45 \\ 0 & 0 & 1 & 8.43 \end{array} \right). \text{ Then } x_3 = 8.43, x_2 = 12.4, x_1 = -3.74.
\end{aligned}$$

Exact solution: $x_1 = -3, x_2 = 10, x_3 = 7$.

Relative error with partial pivoting: $x_1 : 0, x_2 : 0, x_3 : 0$.

Relative error without partial pivoting: $x_1 : 0.247, x_2 : 0.24, x_3 : 0.204$.

7. Exact solution: $x_1 = 15650/13, x_2 = -15000/13$.

Rounding to three significant figures we have: $x_1 + x_2 = 50$
 $x_1 + 1.03x_2 = 20$

Then $x_1 = 1050, x_2 = -1000$. Approximate relative error: $x_1 : 0.1278$
 $x_2 : 0.1333$

Thus the system is ill-conditioned.

8. Exact solution: $x_1 = -1.0001, x_2 = 1.9999$. Rounding to three significant figures we have the same system and thus the same solution. Thus the system is not ill-conditioned.

Application 1. Linear Programming

Application 1.1

1.

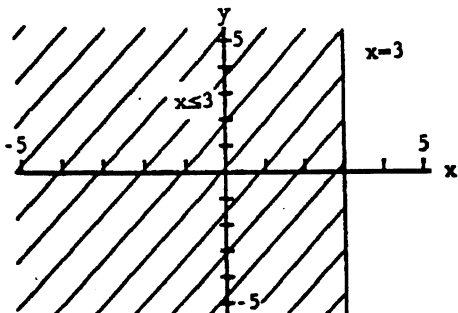

2.

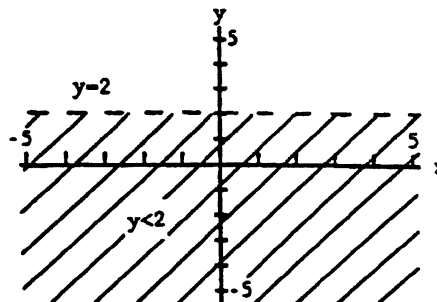

3.

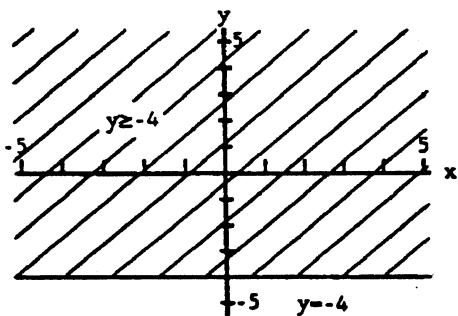

4.

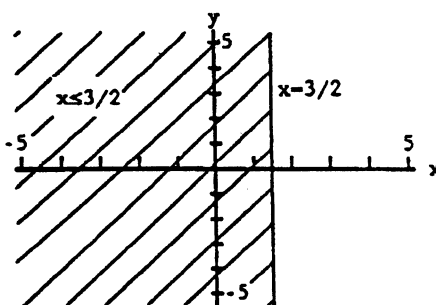

5.

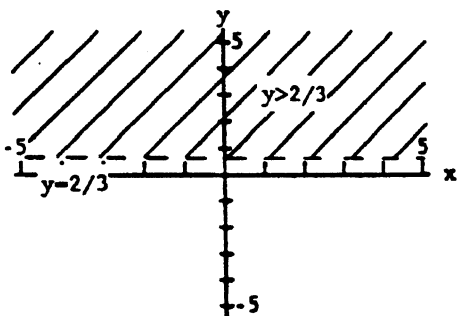

6.

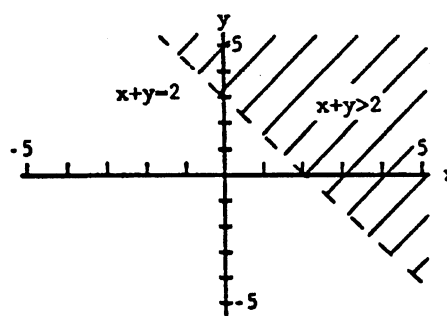

7.

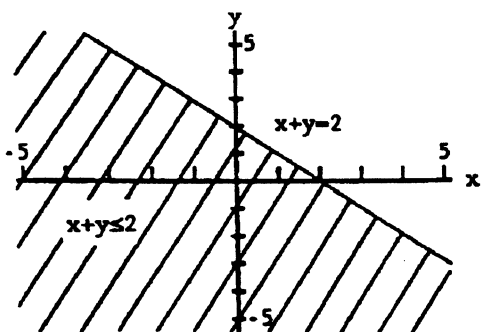

8.

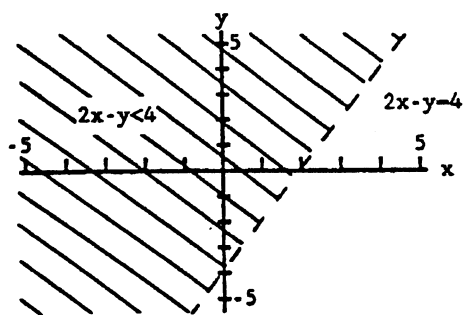

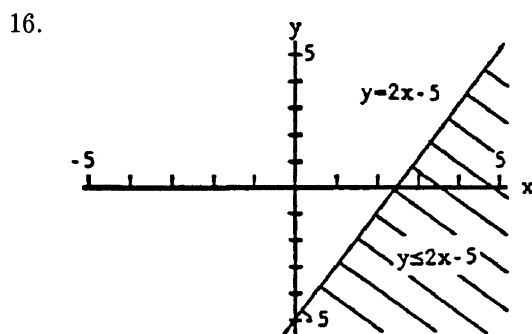
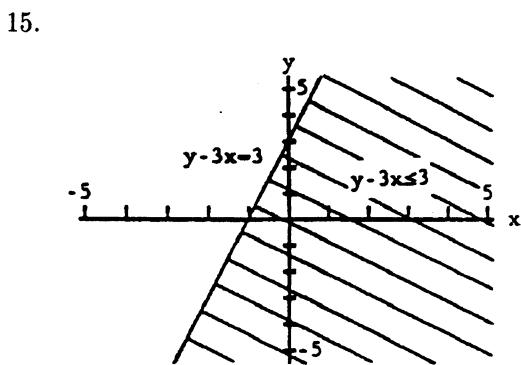
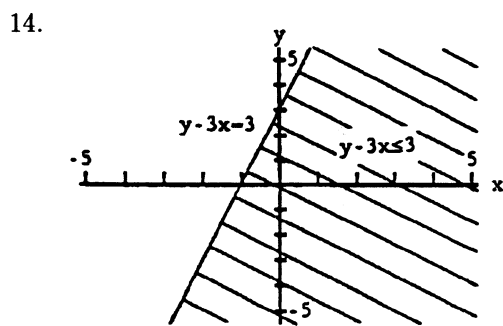
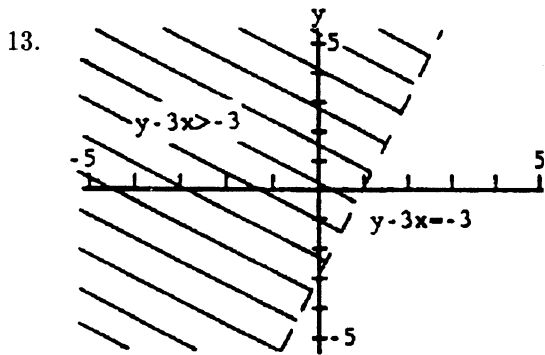
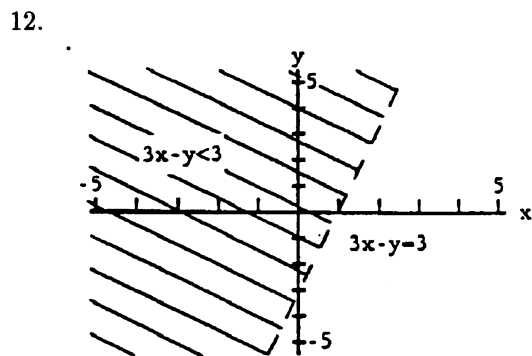
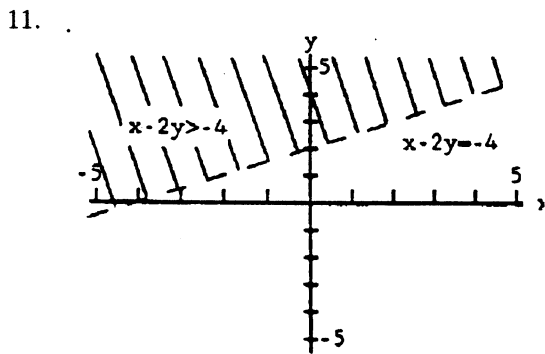
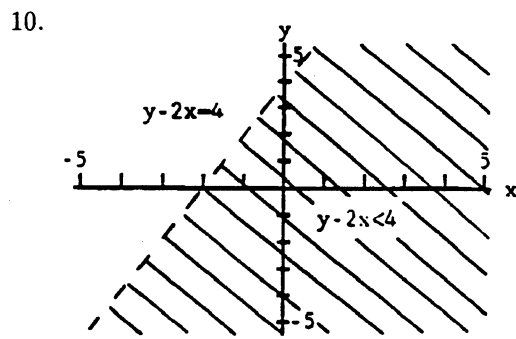
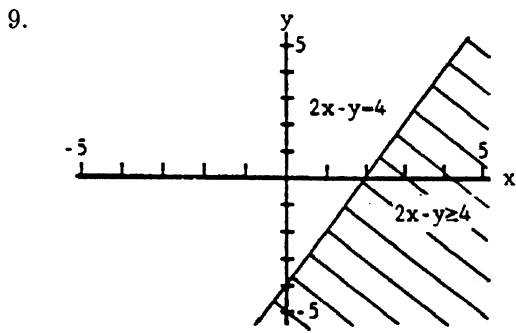

17.

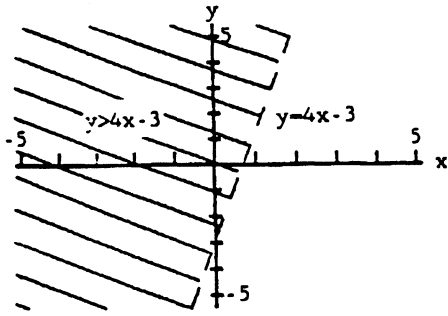

18.

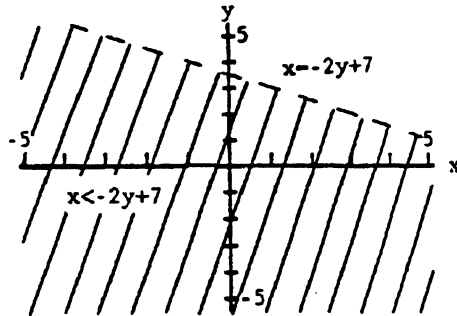

19.

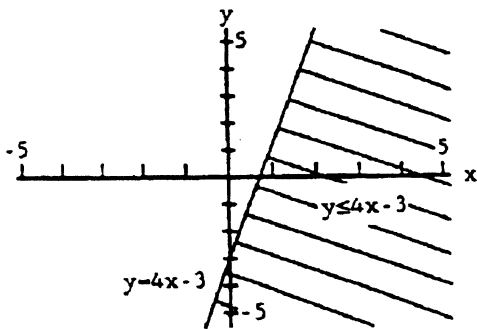

20.

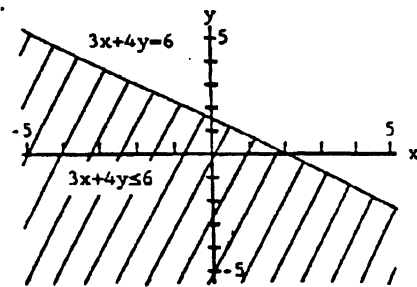

21.

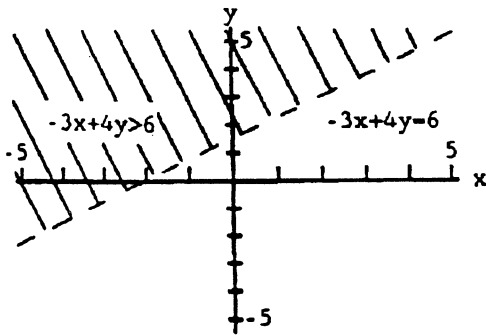

22.

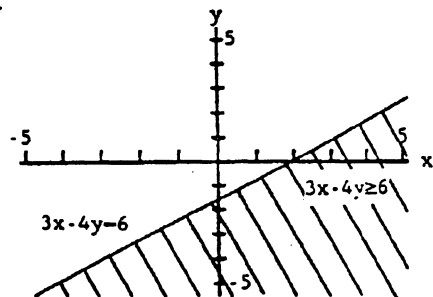

23.

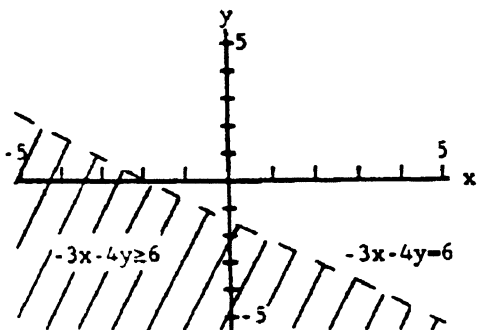

24.

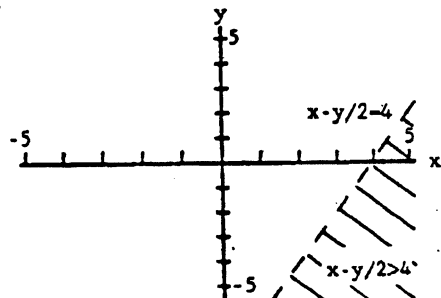

25.

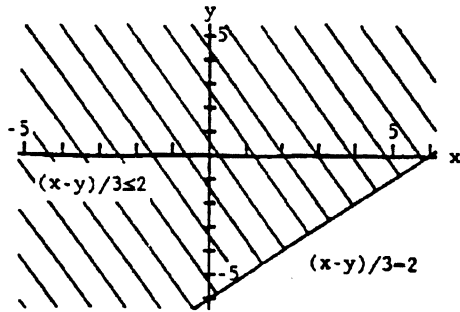

26.

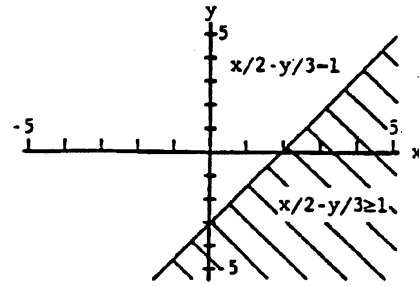

27.

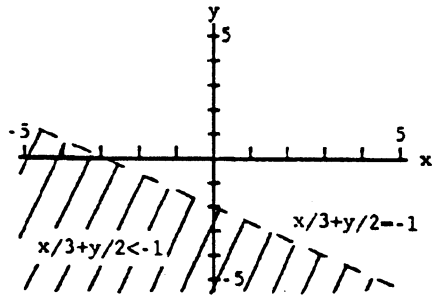

28.

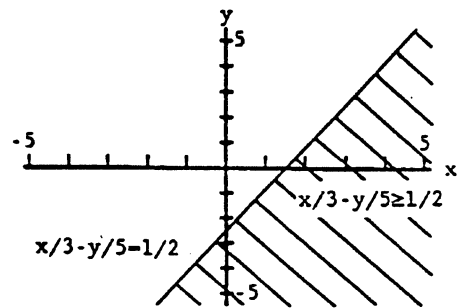

29.

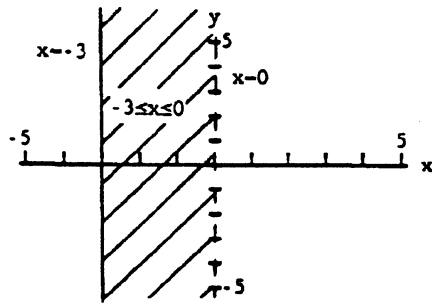

30.

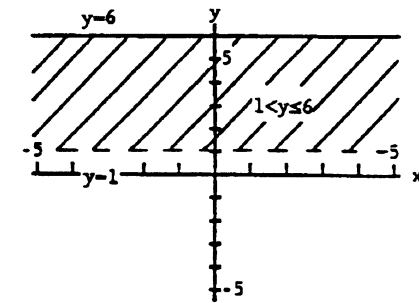

31.

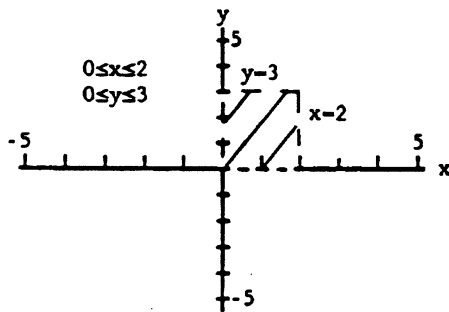

32.

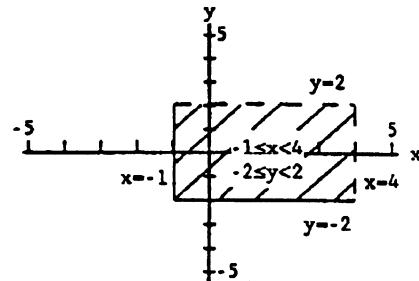

33.

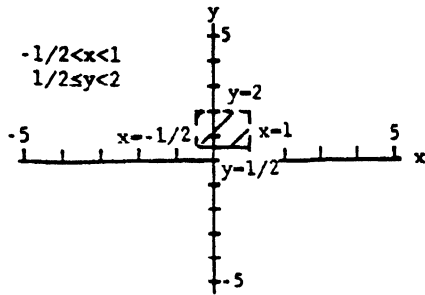

34.

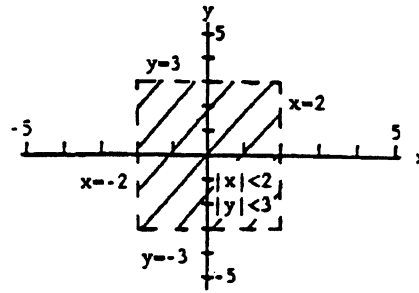

35.

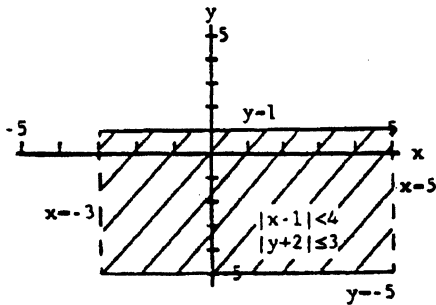

36.

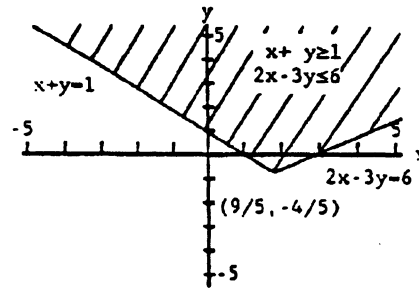

37.

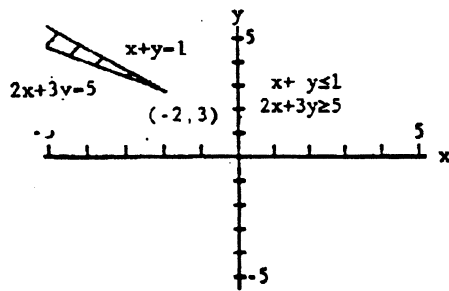

38.

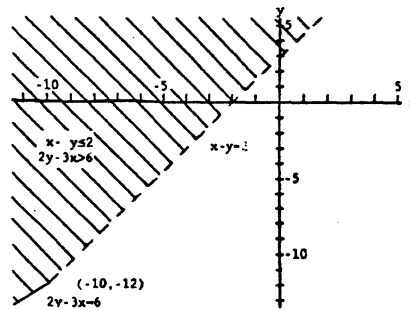

39.

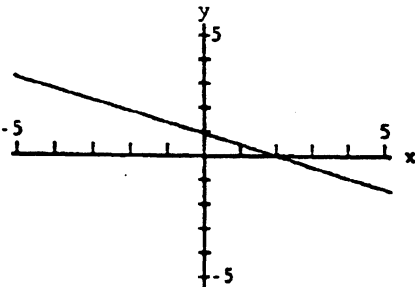

40. No points of intersection.

41.

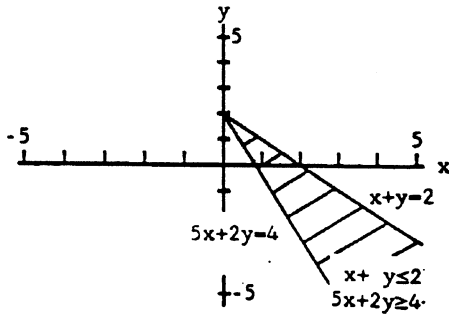

42.

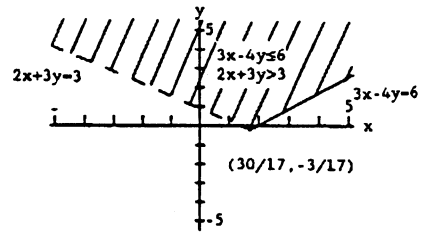

43.

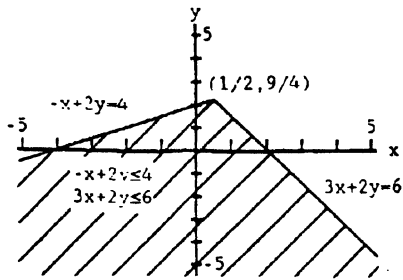

44.

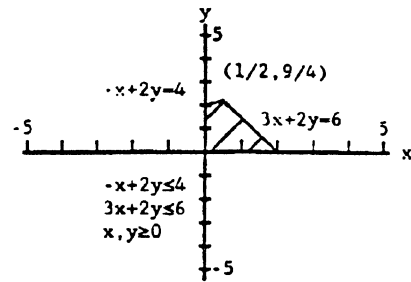

45.

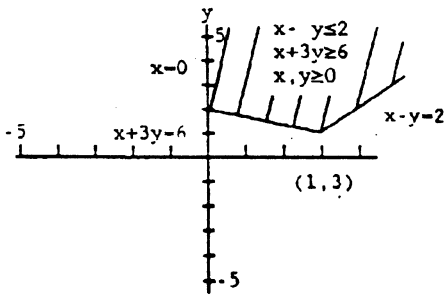

46.

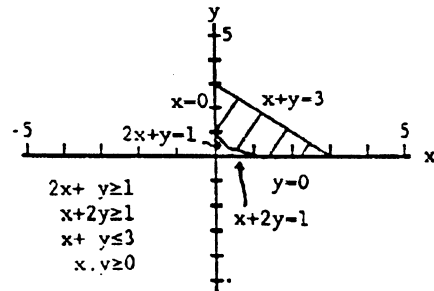

47.

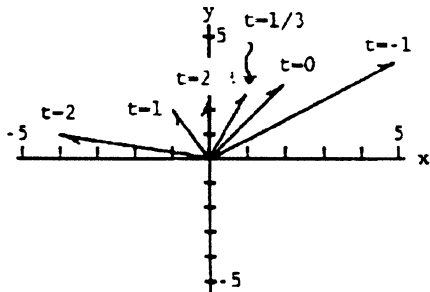

- $t = -1 : (5, 4)$
- $g = 0 : (2, 3)$
- $t = 1/3 : (1, 8/3)$
- $t = 2/3 : (0, 7/3)$
- $t = 1 : (-1, 2)$
- $t = 2 : (-4, 1)$

48.

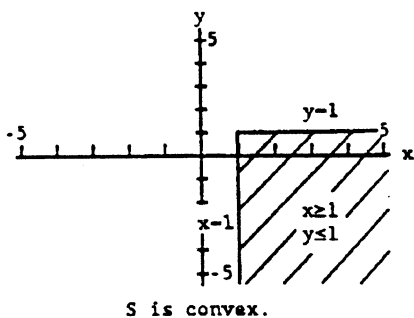

49.

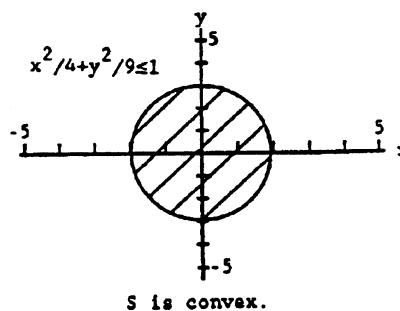

50. S is the empty set.

51.

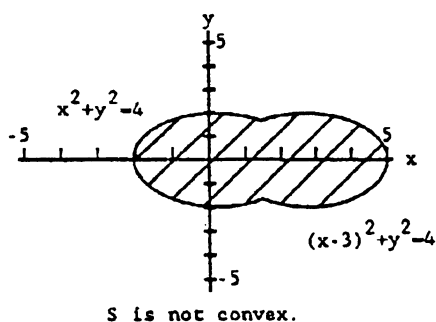

52.

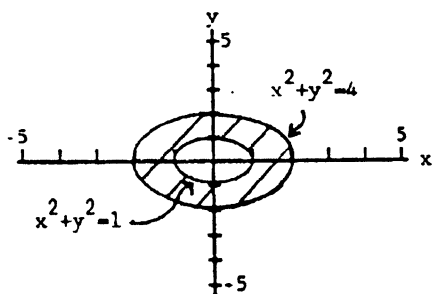

53.

- a). See #48.
- b). See #49.
- c). See #50.
- d). See #51.
- e). See #52.

- 54. (a) $ax_1 + bx_2 + cx_3 = a$ where $a, b, c \in \mathbb{R}$.
- (b) Those for which $b = a$.
- (c) $b = c = 0$.

- 55. (a) $ax_1 + bx_2 + cx_3 + ax_4 = a + b + c$
- (b) Those for which $a + b + c = 0$.
- (c) Those for which $a + b + c = -a$. That is, $b + c = -2a$.

$$\begin{array}{r} 2x_1 + 12x_2 + 2x_3 \leq 10 \\ x_1 - 2x_2 + x_3 < 2 \\ \hline 3x_1 \quad 3x_3 \leq 12 \end{array}$$

$\Rightarrow x_1 + x_3 \leq 4$. But, we also are given $x_1 + x_3 \geq 6$.

Thus, the solution set is empty.

- 57. (a) $\{y : 1 \leq y \leq 3\}$ (b) 3 (c) $\{y : 1 \leq y \leq 6\}$

58. $A = \begin{pmatrix} 1 & 2 \\ -1 & 0 \\ 0 & -1 \end{pmatrix}, b = \begin{pmatrix} 5 \\ 0 \\ 0 \end{pmatrix}$. 59. $A = \begin{pmatrix} 1 & -2 \\ 1 & 1 \\ 1 & 3 \end{pmatrix}, b = \begin{pmatrix} 4 \\ 2 \\ 3 \end{pmatrix}$.

$$60. A = \begin{pmatrix} 1 & 1 & 1 \\ 1 & 3 & 4 \\ -1 & 0 & 0 \\ 0 & -1 & 0 \end{pmatrix}, b = \begin{pmatrix} 1 \\ 3 \\ 0 \\ 0 \end{pmatrix}$$

$$61. A = \begin{pmatrix} 1 & -1 & 2 \\ 1 & 3 & -1 \\ -1 & 1 & 1 \end{pmatrix}, b = \begin{pmatrix} 5 \\ 5 \\ 5 \end{pmatrix}$$

62.

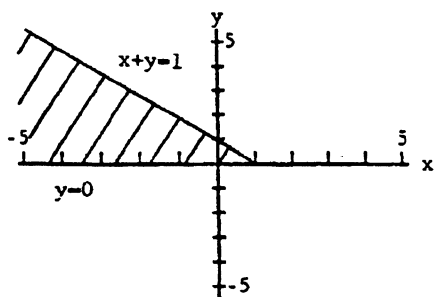

63.

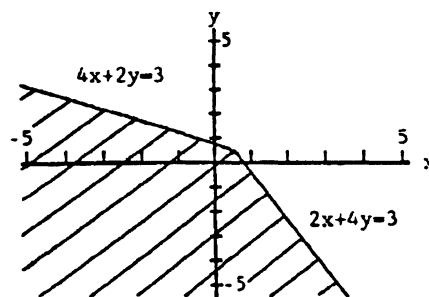

64.

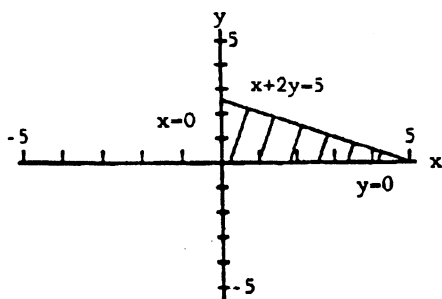

65.

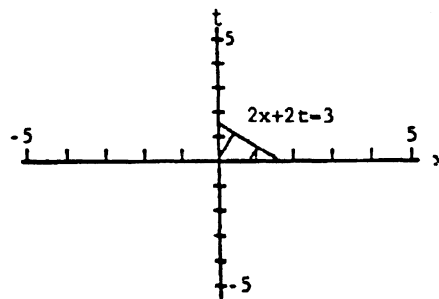

Application 1.2

1. 65 chairs; 40 tables; Profit = \$525
2. 95 chairs; no tables; Profit = \$760
3. We have $P = 5x + 6y$, $30x + 40y \leq 11,400$, $4x + 6y \leq 1,650$, $x \geq 0$, and $y \geq 0$. The corner points are $(0, 0)$, $(380, 0)$, $(0, 275)$, and $(120, 195)$. A maximum profit of \$1,900 is earned when 380 chairs and no tables are produced.
4. no chairs; 275 tables; Profit = \$2,200
5. 380 chairs; no tables; Profit = \$3,040
6. We have $ax + ay \leq c$, $bx + by \leq d$, $x \geq 0$, and $y \geq 0$. If $c/a \leq d/b$, then the corner points are $(0, 0)$, $(0, c/a)$ and $(c/a, 0)$. If $d/b \leq c/a$, then the corner points are $(0, 0)$, $(0, d/b)$, and $(d/b, 0)$. In either case, as $P = 3x + 4y$, the owner will maximize profits by producing tables only.
7. The corner points are $(0, 10)$, $(5, 5)$, and $(5, 10)$. So the cost is minimized at \$4,000 per day if $x = 5$ mgd and $y = 5$ mgd.
8. corner points: $(0, 0)$, $(0, 4)$, $(5/2, 0)$, $(1, 3)$
 $f(0, 4) = 16$, $f(5/2, 0) = 15/2$, $f(1, 3) = 15$
 f is maximized at $(0, 4)$
9. corner points: $(0, 0)$, $(0, 4)$, $(5/2, 0)$, $(1, 3)$
 $f(0, 4) = 12$, $f(5/2, 0) = 10$, $f(1, 3) = 13$
 f is maximized at $(1, 3)$
10. corner points: $(0, 0)$, $(0, 3)$, $(4, 0)$
 $f(0, 3) = 3$, $f(4, 0) = 4$
 f is maximized at $(4, 0)$
11. corner points: $(0, 0)$, $(0, 10/3)$, $(3, 0)$, $(2, 2)$
 $f(0, 10/3) = 10$, $f(3, 0) = 6$, $f(2, 2) = 10$
any point on the line $2x + 3y = 10$ between $(0, 10/3)$ and $(2, 2)$ will yield the maximum value $f = 10$
12. corner points: $(0, 0)$, $(0, 1)$, $(1, 0)$, $(10/11, 10/11)$
 $f(0, 1) = 5$, $f(1, 0) = 3$, $f(10/11, 10/11) = 80/11$
 f is maximized at $(10/11, 10/11)$
13. $f(0, 1) = 3$, $f(1, 0) = 5$, $f(10/11, 10/11) = 80/11$
 f is maximized at $(10/11, 10/11)$
14. $f(0, 1) = 1$, $f(1, 0) = 12$, $f(10/11, 10/11) = 130/11$
 f is maximized at $(1, 0)$
15. $f(0, 1) = 12$, $f(1, 0) = 1$, $f(10/11, 10/11) = 130/11$
 f is maximized at $(0, 1)$
16. corner points: $(0, 4)$, $(4, 0)$
 $g(0, 4) = 20$, $g(4, 0) = 16$
 g is minimized at $(4, 0)$
17. corner points: $(0, 3)$, $(4, 0)$, $(2, 1)$
 $g(0, 3) = 15$, $g(4, 0) = 16$, $g(2, 1) = 13$
 g is minimized at $(2, 1)$
18. corner points: $(0, 1)$, $(1/3, 0)$, $(1/5, 1/5)$
 $g(0, 1) = 8$, $g(1/3, 0) = 4$, $g(1/5, 1/5) = 4$
any point on the line $12x + 8y = 4$ between $(1/5, 1/5)$ and $(1/3, 0)$ will yield the minimum value $g = 4$

19. corner points: $(0, 1)$, $(1, 0)$, $(1/13, 8/13)$
 $g(0, 1) = 7$, $g(1, 0) = 3$, $g(1/13, 8/13) = 59/13$
 g is minimized at $(1, 0)$
20. corner points: $(2, 0)$, $(0, 5/2)$
 $g(2, 0) = 6$, $g(0, 5/2) = 5$
 g is minimized at $(0, 5/2)$
21. Let x and y denote the amount of the first and second food groups, respectively. We want to minimize $f = 0.5x + y$ subject to the constraints: $0.9x + 0.6y \geq 2$, $0.1x + 0.4y \geq 1$, $x \geq 0$, and $y \geq 0$. The corner points are $(10, 0)$, $(0, 10/3)$, and $(2/3, 7/3)$. Upon computing f at the corner points, we find that $2/3$ lb of Food I and $7/3$ lb of Food II provides the diet requirements at minimum cost. The cost per lb is $\$ 8/9 \approx 89$ cents.
22. Let x and y denote the number of regular and super deluxe pizzas, respectively. We want to maximize $P = 0.5x + 0.75y$ subject to the constraints: $x + y \leq 150$, $4x + 8y \leq 800$, $0 \leq x \leq 125$, and $0 \leq y \leq 75$. The corner points are $(0, 0)$, $(0, 75)$, $(50, 75)$, $(100, 50)$, $(125, 25)$, and $(125, 0)$. Upon evaluating P at the corner points, we find that when Art makes 100 regular pizzas and 50 super deluxe pizzas, his profit is maximized at $\$87.50$.
23. Let x and y denote the number of species I and II, respectively. We want to minimize $E = 3x + 2y$ subject to the constraints $5x + y \geq 10$, $2x + 2y \geq 12$, $x + 4y \geq 12$, $x \geq 0$, and $y \geq 0$. The corner points are $(1, 5)$, $(4, 2)$, $(0, 10)$, and $(12, 0)$. Upon evaluating E at the corner points, we find that if $x = 1$ and $y = 5$, then the energy expended will be minimized at 13 units.

24. (a)

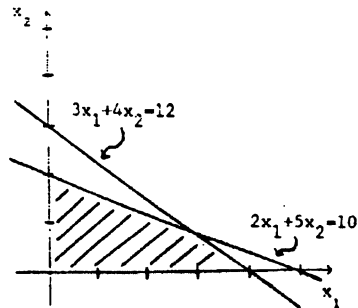

(b)

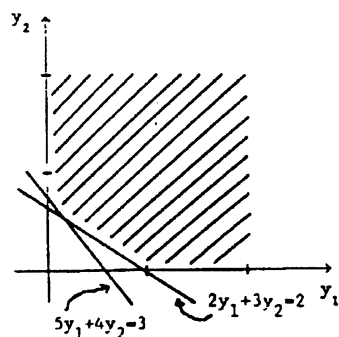

- (c) By sketching lines, observe that f is maximized at $(20/7, 6/7)$ with $f = 58/9$, and g is minimized at $(1/7, 4/7)$ with $g = 58/7$.

25. (a)

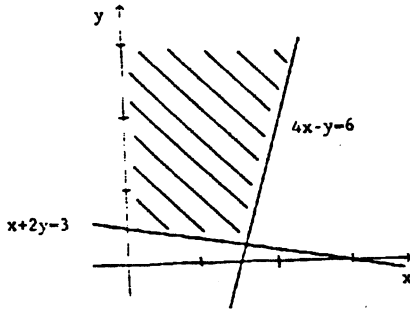

(b) The first two inequalities are satisfied for all (x_1, x_2, x_3) as long as $x_1 + x_3 \geq 5$ and $x_2 \geq x_1 + x_3 - 8$. Hence the problem is unbounded.

26. (a)

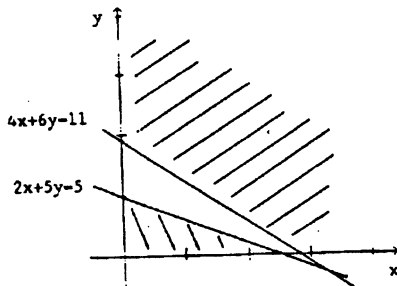

(b) From the first two inequalities we have that $6x_1 + 4x_2 + 3x_3 \leq 14$, but this contradicts the third inequality.

27. (a) Minimize $C = 2x_1 + 2.5x_2 + 0.8x_3$ subject to the constraints: $x_1 + x_2 + 10x_3 \geq 1$, $100x_1 + 10x_2 + 10x + 3ge50$, $10x_1 + 100x_2 + 10x_3 \geq 10$, $x_1 \geq 0$, $x_2 \geq 0$, and $x_3 \geq 0$.

(b) $(0, 0, 0)$; $(0, 0, 1/10)$; $(0, 0, 5)$; $(0, 0, 1)$; $(0, 1, 0)$; $(0, 5, 0)$; $(0, 1/10, 0)$; $(1, 0, 0)$; $(1/2, 0, 0)$; $(1, 0, 0)$; $(0, 49/9, -4/9)$; $(0, 1/11, 1/11)$; $(0, -4/9, 49/9)$; $(49/99, 0, 5/99)$; $(1, 0, 0)$; $(4/9, 0, 5/9)$; $(4/9, 5/9, 0)$; $(1, 0, 0)$; $(49/99, 5/99, 0)$; $(53/108, 5/108, 5/108)$

(c) $(0, 0, 5)$; $(0, 5, 0)$; $(1, 0, 0)$; $(1, 0, 0)$; $(1, 0, 0)$; $(4/9, 0, 5/9)$; $(4/9, 5/9, 0)$; $(1, 0, 0)$; $(53/108, 5/108, 5/108)$

(d) Feasible solution	Cost (in dollars)
$(0, 0, 5)$	4.00
$(0, 5, 0)$	12.50
$(1, 0, 0)$	2.00
$(4/9, 0, 5/9)$	1.33
$(4/9, 5/9, 0)$	2.28
$(53/108, 5/108, 5/108)$	1.13

(e) Cost is $\$245/216 \approx \1.13 when $x_1 = 53/108 \approx 0.49$ gallon of milk, $x_2 = 5/108 \approx 0.046$ pound of bef, and $x_3 = 5/108 \approx 0.046$ dozen eggs consumed daily.

28. Let x , y , and z denote operations I, II, and III, respectively. We want to maximize $P = 100x + 150y + 200z$ and $N = x + y + z$ subject to the constraints: $0.5x + y_2z \leq 80$, $x \geq 0$, $y \geq 0$. The corner points are $(0, 0, 0)$, $(160, 0, 0)$, $(0, 80, 0)$, and $(0, 0, 40)$. Both P and N are maximized at $(160, 0, 0)$. Hence, to maximize the revenue and the total number of operations, 160 of type I, 0 of type II, and 0 of type III should be performed.

29. Let x_1 , x_2 , and x_3 denote the number of cans of mixtures 1, 2, and 3, respectively. We want to maximize $P = 0.3x_1 + 0.4x_2 + 0.5x_3$ subject to the constraints: $\frac{1}{2}x_1 + \frac{1}{3}x_2 \leq 10,000$, $\frac{1}{2}x_1 + \frac{1}{3}x_2 + \frac{1}{2}x_3 \leq 12,000$, $\frac{1}{3}x_2 + \frac{1}{2}x_3 \leq 8,000$, $x_1 \geq 0$, $x_2 \geq 0$, and $x_3 \geq 0$. The corner points are $(0, 0, 0)$, $(8000, 18000, 4000)$, $(20000, 0, 4000)$, $(4000, 24000, 0)$, $(8000, 0, 16000)$, $(0, 24000, 0)$, and $(20000, 0, 0)$. Upon evaluating P at the corner points, we find that if $(x_1, x_2, x_3) = (8000, 18000, 4000)$, then P is maximized with $P = \$11,600$.

Application 1.3

$$\begin{aligned} x_1 + x_2 + s_1 &= 3 \\ 1. \quad 2x_1 + x_2 + s_2 &= 7 \\ s_1, s_2 &\geq 0 \end{aligned}$$

$$\begin{aligned} 2x_1 + x_2 + s_1 &= 10 \\ 3. \quad 3x_1 + 2x_2 + s_2 &= 30 \\ 4x_1 + 7x_2 + s_3 &= 20 \\ s_1, s_2, s_3 &\geq 0 \end{aligned}$$

$$\begin{aligned} 7x_1 + x_2 + 3x_3 + x_4 + s_1 &= 8 \\ 5. \quad 3x_1 + 2x_2 + 5x_3 + 12x_4 + s_2 &= 12 \\ 2x_1 + 5x_2 + 8x_3 + 2x_4 + s_3 &= 9 \\ s_1, s_2, s_3 &\geq 0 \end{aligned}$$

$$\begin{aligned} x_1 + 2x_2 + s_1 &= 5 \\ 6. \quad (a) \quad 3x_1 + 7x_2 + s_2 &= 20 \\ s_1, s_2 &\geq 0 \end{aligned}$$

$$(b) \quad \left(\begin{array}{cccc|c} 1 & 2 & 1 & 0 & 5 \\ 3 & 7 & 0 & 1 & 20 \end{array} \right) \rightarrow \left(\begin{array}{cccc|c} 1 & 2 & 1 & 0 & 5 \\ 0 & 1 & -3 & 1 & 5 \end{array} \right) \rightarrow \left(\begin{array}{cccc|c} 1 & 0 & 7 & -2 & -5 \\ 0 & 1 & -3 & 1 & 5 \end{array} \right)$$

$$\text{Then } x_1 = -5 - 7s_1 + 2s_2; x_2 = 5 + 3s_1 - s_2.$$

$$7. \quad \left(\begin{array}{cccc|c} 1 & 1 & 2 & 0 & 5 \\ 3 & 0 & 7 & 1 & 20 \end{array} \right) \rightarrow \left(\begin{array}{cccc|c} 1 & 1 & 2 & 0 & 5 \\ 0 & -3 & 1 & 1 & 5 \end{array} \right) \rightarrow \left(\begin{array}{cccc|c} 1 & 0 & 7/3 & 1/3 & 20/3 \\ 0 & 1 & -1/3 & -1/3 & -5/3 \end{array} \right)$$

$$\text{Then } x_1 = (20 - 7x_2 - s_2)/3; s_1 = (-5 + x_2 + s_2)/3.$$

$$8. \quad \left(\begin{array}{cccc|c} 1 & 2 & 1 & 0 & 5 \\ 0 & 7 & 3 & 1 & 20 \end{array} \right) \rightarrow \left(\begin{array}{cccc|c} 1 & 0 & 1/7 & -2/7 & -5/7 \\ 0 & 1 & 3/7 & 1/7 & 20/7 \end{array} \right)$$

$$\text{Then } x_2 = (20 - 3x_1 - 5s_2)/7; s_1 = (-5 - x_1 + 2s_2)/7.$$

$$\begin{aligned} 2x_1 + 5x_2 + s_1 &= 12 \\ 9. \quad (a) \quad 4x_1 + 9x_2 + s_2 &= 20 \\ s_1, s_2 &\geq 0 \end{aligned}$$

$$(b) \quad \left(\begin{array}{cccc|c} 2 & 5 & 1 & 0 & 12 \\ 4 & 9 & 0 & 1 & 20 \end{array} \right) \rightarrow \left(\begin{array}{cccc|c} 1 & 5/2 & 1/2 & 0 & 6 \\ 0 & 1 & 2 & -1 & 4 \end{array} \right) \rightarrow \left(\begin{array}{cccc|c} 1 & 0 & -9/2 & 5/2 & -4 \\ 0 & 1 & 2 & -1 & 4 \end{array} \right)$$

$$\text{Then } x_1 = (-8 + 9s_1 - 5s_2)/2; x_2 = 4 - 2s_1 + s_2.$$

$$10. \quad \left(\begin{array}{cccc|c} 2 & 0 & 5 & 1 & 12 \\ 4 & 1 & 9 & 0 & 20 \end{array} \right) \rightarrow \left(\begin{array}{cccc|c} 1 & 0 & 5/2 & 1/2 & 6 \\ 0 & 1 & -1 & -2 & -4 \end{array} \right)$$

$$\text{Then } x_1 = (12 - 5x_2 - s_1)/2; s_2 = -4 + x_2 + 2s_1.$$

$$\begin{aligned} x_1 + 2x_2 + x_3 + s_1 &= 8 \\ 11. \quad (a) \quad 2x_1 + 5x_2 + 5x_3 + s_2 &= 35 \\ s_1, s_2 &\geq 0 \end{aligned}$$

$$(b) \quad \left(\begin{array}{cccc|c} 1 & 2 & 1 & 1 & 8 \\ 2 & 5 & 5 & 0 & 35 \end{array} \right) \rightarrow \left(\begin{array}{cccc|c} 1 & 2 & 1 & 1 & 8 \\ 0 & 1 & 3 & -2 & 19 \end{array} \right) \rightarrow \left(\begin{array}{cccc|c} 1 & 0 & -5 & 5 & -30 \\ 0 & 1 & 3 & -2 & 19 \end{array} \right)$$

$$\text{Then } x_1 = -30 + 5x_3 - 5s_1 + 2s_2; x_2 = 19 - 3x_3 + 2s_1 - s_2.$$

12. (a) Same as 11a).

$$(b) \quad \left(\begin{array}{cccc|c} 1 & 1 & 2 & 1 & 8 \\ 0 & 2 & 5 & 5 & 35 \end{array} \right) \rightarrow \left(\begin{array}{cccc|c} 1 & 0 & -1/2 & -3/2 & -19/2 \\ 0 & 1 & 5/2 & 5/2 & 35/2 \end{array} \right)$$

$$\text{Then } x_1 = (35 - 5x_2 - 5x_3 - s_2)/2; s_1 = (-19 + x_2 + 3x_3 + s_2)/2.$$

13. (a) Same as 11a).

$$(b) \left(\begin{array}{cccc|c} 2 & 1 & 1 & 1 & 0 & 8 \\ 5 & 5 & 2 & 0 & 1 & 35 \end{array} \right) \rightarrow \left(\begin{array}{cccc|c} 1 & 1/2 & 1/2 & 1/2 & 0 & 4 \\ 0 & 5/2 & -1/2 & -5/2 & 1 & 15 \end{array} \right) \rightarrow \left(\begin{array}{cccc|c} 1 & 0 & 3/5 & 1 & -1/5 & 1 \\ 0 & 1 & -1/5 & -1 & 2/5 & 6 \end{array} \right)$$

$$\text{Then } x_2 = (5 - 3x_1 - 5s_1 + s_2)/5; x_3 = (30 + x_1 + 5s_1 - 2s_2)/5.$$

14. (a) Same as 11a).

$$(b) s_1 = 8 - x_1 - x_2 - 2x_3; s_2 = 35 - 2x_1 - 5x_2 - 5x_3.$$

$$\begin{array}{rcl} x_1 + 3x_2 + s_1 & = & 5 \\ 2x_1 + 7x_2 & +s_2 & = 20 \\ 3x_1 + 8x_2 & +s_3 & = 40 \\ s_1, s_2, s_3 & \geq & 0 \end{array}$$

$$(b) \left(\begin{array}{cccc|c} 1 & 3 & 1 & 0 & 0 & 5 \\ 2 & 7 & 0 & 1 & 0 & 20 \\ 3 & 8 & 0 & 0 & 1 & 40 \end{array} \right) \rightarrow \left(\begin{array}{cccc|c} 1 & 3 & 1 & 0 & 0 & 5 \\ 0 & 1 & -2 & 1 & 0 & 10 \\ 0 & -1 & -3 & 0 & 1 & 25 \end{array} \right) \rightarrow \left(\begin{array}{cccc|c} 1 & 0 & 7 & -3 & 0 & -25 \\ 0 & 1 & -2 & 1 & 0 & 10 \\ 0 & 0 & -5 & 1 & 1 & 35 \end{array} \right)$$

$$\rightarrow \left(\begin{array}{cccc|c} 1 & 0 & 0 & -8/5 & 7/5 & 24 \\ 0 & 1 & 0 & 3/5 & -2/5 & -4 \\ 0 & 0 & 1 & -1/5 & -1/5 & -7 \end{array} \right)$$

$$\text{Then } x_1 = (120 + 8s_2 - 7s_3)/5; x_2 = (-20 - 3s_2 + 2s_3)/5; s_1 = (-35 + s_2 + s_3)/5.$$

16. (a) Same as 15a).

$$(b) \left(\begin{array}{cccc|c} 3 & 0 & 0 & 1 & 1 & 5 \\ 7 & 1 & 0 & 2 & 0 & 20 \\ 8 & 0 & 1 & 3 & 0 & 40 \end{array} \right) \rightarrow \left(\begin{array}{cccc|c} 1 & 0 & 0 & 1/3 & 1/3 & 5/3 \\ 0 & 1 & 0 & -1/3 & -7/3 & 25/3 \\ 0 & 0 & 1 & 1/3 & -8/3 & 80/3 \end{array} \right)$$

$$\text{Then } x_2 = (5 - x_1 - s_1)/3; s_2 = (25 + x_1 + 7s_1)/3; s_3 = (80 - x_1 + 8s_1)/3.$$

$$\begin{array}{rcl} 2x_1 + 4x_2 + 8x_3 + s_1 & = & 12 \\ 2x_1 + 5x_2 + 12x_3 & +s_2 & = 25 \\ 3x_1 + 6x_2 + 13x_3 & +s_3 & = 60 \\ s_1, s_2, s_3 & \geq & 0 \end{array} \quad (b) \begin{array}{l} s_1 = 12 - 2x_1 - 4x_2 - 8x_3 \\ s_2 = 25 - 2x_1 - 5x_2 - 12x_3 \\ s_3 = 60 - 3x_1 - 6x_2 - 13x_3 \end{array}$$

18. Same as 17a)

$$(b) \left(\begin{array}{cccc|c} 2 & 4 & 8 & 1 & 0 & 0 & 12 \\ 2 & 5 & 12 & 0 & 1 & 0 & 25 \\ 3 & 6 & 13 & 0 & 0 & 1 & 60 \end{array} \right) \rightarrow \left(\begin{array}{cccc|c} 1 & 2 & 4 & 1/2 & 0 & 0 & 6 \\ 0 & 1 & 4 & -1 & 1 & 0 & 13 \\ 0 & 0 & 1 & -3/2 & 0 & 1 & 42 \end{array} \right)$$

$$\rightarrow \left(\begin{array}{cccc|c} 1 & 0 & -4 & 5/2 & -2 & 0 & -20 \\ 0 & 1 & 4 & -1 & 1 & 0 & 13 \\ 0 & 0 & 1 & -3/2 & 0 & 1 & 42 \end{array} \right) \rightarrow \left(\begin{array}{cccc|c} 1 & 0 & 0 & -7/2 & -2 & 4 & 148 \\ 0 & 1 & 0 & 5 & 1 & -4 & -155 \\ 0 & 0 & 1 & -3/2 & 0 & 1 & 42 \end{array} \right)$$

$$\text{Then } x_1 = 148 + 7s_1/2 + 2s_2 - 4s_3; x_2 = -155 - 5s_1 - s_2 + 4s_3; x_3 = 24 + 3s_1/2 - s_3.$$

19. (a) Same as 17a).

$$(b) \left(\begin{array}{cccc|c} 1 & 2 & 0 & 4 & 8 & 0 & 12 \\ 0 & 2 & 0 & 5 & 12 & 1 & 25 \\ 0 & 3 & 1 & 6 & 13 & 0 & 60 \end{array} \right) \rightarrow \left(\begin{array}{cccc|c} 1 & 0 & 0 & -1 & -4 & -1 & -13 \\ 0 & 1 & 0 & 5/2 & 6 & 1/2 & 25/2 \\ 0 & 0 & 1 & -3/2 & -5 & -3/2 & 45/2 \end{array} \right)$$

$$\text{Then } x_1 = (25 - 5x_2 - 12x_3 - s_2)/2; s_1 = -13 + x_2 + 4x_3 + s_2; s_3 = (45 + 3x_2 + 10x_3 + 3s_2)/2.$$

20. (a) Same as 17a).

$$(b) \left(\begin{array}{cccc|c} 1 & 2 & 8 & 4 & 0 & 0 & 12 \\ 0 & 2 & 12 & 5 & 1 & 0 & 25 \\ 0 & 3 & 13 & 6 & 0 & 1 & 60 \end{array} \right) \rightarrow \left(\begin{array}{cccc|c} 1 & 0 & -4 & -1 & -1 & 0 & -13 \\ 0 & 1 & 6 & 5/2 & 1/2 & 0 & 25/2 \\ 0 & 0 & -5 & -3/2 & -3/2 & 1 & 45/2 \end{array} \right) \rightarrow$$

$$\left(\begin{array}{cccc|c} 1 & 0 & 0 & 1/5 & 1/5 & -4/5 & -31 \\ 0 & 1 & 0 & 7/10 & -13/10 & 6/5 & 79/2 \\ 0 & 0 & 1 & 3/10 & 3/10 & -1/5 & -9/2 \end{array} \right) \text{ Then } x_1 = (395 - 7x_2 + 13s_2 - 12s_3)/10;$$

$$x_3 = (-45 - 3x_2 - 3s_2 + 2s_3)/10; s_1 = (-155 - x_2 - s_2 + 4s_3)/5.$$

Application 1.4

Note: pivots are in parentheses.

1.

(2)	-1	(2)	1	0	1
-2	0	3	0	1	2
1	1	1	0	0	<i>f</i>

2.

(1)	(1)	(1)	1	0	1
-1	0	1	0	1	2
2	1	3	0	0	<i>f</i>

3.

1	2	3	1	0	0	5
2	3	1	0	1	0	3
(3)	1	(2)	0	0	1	1
2	-1	3	0	0	0	<i>f</i>

4.

(1)	1	1	0	1
(2)	(5)	0	1	2
2	1	0	0	<i>f</i>

5.

2	3	1	0	7
(5)	8	0	1	4
1	-1	0	0	<i>f</i>

6.

1	(2)	1	0	0	5
(3)	2	0	1	0	7
5	3	0	0	1	14
4	3	0	0	0	<i>f</i>

7.

1	(1)	1	1	0	5
(2)	1	(3)	0	1	6
3	2	4	0	0	<i>f</i>

8.

1	-1	-1	1	0	0	5
-1	(1)	(2)	0	1	0	6
(2)	-1	1	0	0	1	7
2	1	3	0	0	0	<i>f</i>

9.

1	(1)	1	1	0	0	5
1	-2	2	0	1	0	6
(2)	-1	1	0	0	1	4
1	1	-3	0	0	0	<i>f</i>

10.

x_1	x_2	x_3	x_4	s_1	s_2	
3	0	14/3	25/3	1	1/3	5/3
1	1	2/3	7/3	0	1/3	2/3
0	0	-1/6	-13/3	0	-1/3	$f - 2/3$

 s_1
 x_2

11.

x_1	x_2	x_3	s_1	s_2	
2	3	2	1	0	2
-1	0	4	0	1	2
1	2	0	0	0	<i>f</i>

 s_1
 s_2 →

x_1	x_2	x_3	s_1	s_2	
1	3/2	1	1/2	0	1
0	3/2	5	1/2	1	3
0	1/2	-1	-1/2	0	$f - 1$

 x_1
 s_2
→

x_1	x_2	x_3	s_1	s_2	
2/3	1	2/3	1/3	0	2/3
-1	0	4	0	1	2
-1/3	0	-4/3	-2/3	0	$f - 4/3$

 x_2
 s_2

12.

x_1	x_2	x_3	s_1	s_2	
1	-1/2	1	1/2	0	1/2
0	-1	5	1	1	3
0	3/2	0	-1/2	0	$f - 1/2$

 x_1
 s_2

The solution is unbounded.

13.

x_1	x_2	x_3	s_1	s_2	
1	1	1	1	0	1
-2	-1	0	-1	1	1
-1	-2	0	-3	0	$f - 3$

 x_3
 s_2

14.

x_1	x_2	x_3	s_1	s_2	s_3
-7/2	1/2	0	1	0	-3/2
1/2	5/2	0	0	1	-1/2
3/2	1/2	1	0	0	1/2
-5/2	-5/2	0	0	0	-3/2

 s_2
 s_2
 x_3
 $f - 3/2$

15.

x_1	x_2	s_1	s_2
2	3	1	0
5	8	0	1
1	-1	0	0

 s_1
 s_2 \rightarrow

x_1	x_2	s_1	s_2
0	-1/5	1	-2/5
1	8/5	0	1/5
0	-13/5	0	-1/5

 s_1
 x_1
 $f - 4/5$
 (4/5, 0); $f = 4/5$

16.

x_1	x_2	s_1	s_2
1	1	1	0
2	5	0	1
2	1	0	0

 s_1
 s_2 \rightarrow

x_1	x_2	s_1	s_2
1	1	1	0
0	3	-2	1
0	-1	-2	0

 x_1
 s_2
 $f - 2$
 (1, 0); $f = 2$

17.

x_1	x_2	s_1	s_2
2	3	1	0
3	2	0	1
4	5	0	0

 s_1
 s_2 \rightarrow

x_1	x_2	s_1	s_2
0	5/3	1	-2/3
1	2/3	0	1/3
0	7/3	0	-4/3

 s_1
 x_1
 $f - 20/3$
 \rightarrow

x_1	x_2	s_1	s_2
0	1	3/5	-2/5
1	0	-2/5	3/5
0	0	-7/5	-2/5

 x_2
 x_1 (3/5, 8/5); $f = 52/5$

18.

x_1	x_2	x_3	s_1	s_2	s_3
1	1	0	1	0	0
0	1	0	0	1	0
0	1	2	0	0	1
1	2	1	0	0	0

 s_1
 s_2
 s_3 \rightarrow

x_1	x_2	x_3	s_1	s_2	s_3
1	0	0	1	-1	0
0	1	0	0	1	0
0	0	1	0	-1/2	1/2
0	0	0	-1	-1/2	-1/2

 x_1
 x_2
 x_3
 $f - 4$
 (1, 1, 1); $f = 4$

19.

x_1	x_2	x_3	s_1	s_2	s_3
1	1	1	1	0	0
1	-2	2	0	1	0
2	-1	1	0	0	1
1	1	-3	0	0	0

 s_1
 s_2
 s_3 \rightarrow

x_1	x_2	x_3	s_1	s_2	s_3
0	1	1/3	2/3	0	-1/3
0	0	2	1	1	-1
-1	0	2/3	1/3	0	1/3
0	0	-4	-1	0	0

 x_2
 s_2
 x_1
 $f - 5$
 (3, 2, 0); $f = 5$; or (0, 5, 0) or ... There are an infinite number of solutions in the constraint set.

20.

x_1	x_2	x_3	s_1	s_2	s_3
1	-1	-1	1	0	0
-1	1	2	0	1	0
2	-1	1	0	0	1
2	1	3	0	0	0

 s_1
 s_2
 s_3 \rightarrow

x_1	x_2	x_3	s_1	s_2	s_3
0	0	1	1	1	0
0	1	5	0	2	1
1	0	3	0	1	1
0	0	-8	0	-4	-3

 s_1
 x_2
 x_1
 $f - 45$
 (13, 19, 0); $f = 45$

21.

x_1	x_2	s_1	s_2	s_3	s_4	
1	1	1	0	0	0	3
1	2	0	1	0	0	4
1	0	0	0	1	0	5/2
0	1	0	0	0	1	3/2
5	8	0	0	0	0	f

 s_1
 s_2
 s_3
 s_4

→

x_1	x_2	s_1	s_2	s_3	s_4	
0	1	-1	1	0	0	1
0	0	-2	1	1	0	1/2
1	0	2	-1	0	0	2
0	0	1	-1	0	1	1/2
0	0	-2	-3	0	0	$f-18$

 x_2
 s_3
 x_1
 s_4

(2, 1); $f = 18$

22.

x_1	x_2	x_3	s_1	s_2	s_3	s_4	
1	0	0	1	0	0	0	3
0	4	1	0	1	0	0	2
1	-1	0	0	0	1	0	0
0	0	1	0	0	0	1	1
5	1	3	0	0	0	0	f

 s_1
 s_2
 s_3
 s_4

→

x_1	x_2	x_3	s_1	s_2	s_3	s_4	
0	0	0	1	-1/4	-1	1/4	11/4
0	1	0	0	1/4	0	-1/4	1/4
1	0	0	0	1/4	1	-1/4	1/4
0	0	1	0	0	0	1	1
0	0	0	0	-3/2	-5	-3/2	$f-9/2$

 s_1
 x_2
 x_1
 x_3

(1/4, 1/4, 1); $f = 9/2$

23.

x_1	x_2	x_3	s_1	s_2	s_3	
1	3	6	1	0	0	12
3	2	4	0	1	0	10
-1	2	1	0	0	1	5
1	2	2	0	0	0	f

 s_1
 s_2
 s_3

→

x_1	x_2	x_3	s_1	s_2	s_3	
0	0	21/8	1	-5/8	-7/8	11/8
1	0	3/4	0	1/4	-1/4	5/4
0	1	7/8	0	1/8	3/8	25/8
0	0	-1/2	0	-1/2	-1/2	$f-15/2$

 s_1
 x_1
 x_2

(5/4, 25/8, 0); $f = 15/2$

24.

x_1	x_2	x_3	s_1	s_2	s_3	
1	1	-1	1	0	0	1
1	-1	1	0	1	0	2
-1	1	1	0	0	1	3
1	2	3	0	0	0	f

 s_1
 s_2
 s_3

→

x_1	x_2	x_3	s_1	s_2	s_3	
0	1	0	1/2	0	1/2	2
1	0	0	1/2	1/2	0	3/2
0	0	1	0	1/2	1/2	5/2
0	0	0	-3/2	-2	-5/2	$f-13$

 x_2
 x_1
 x_3

(3/2, 2, 5/2); $f = 13$

25.

x_1	x_2	x_3	s_1	s_2	s_3	s_4	
1	1	2	1	0	0	0	5
2	1	1	0	1	0	0	7
2	-1	3	0	0	1	0	8
1	2	5	0	0	0	1	9
1	-1	1	0	0	0	0	f

 s_1
 s_2
 s_3
 s_4

→

x_1	x_2	x_3	s_1	s_2	s_3	s_4	
0	2	0	1	-1/4	-3/4	0	3/4
1	1	0	0	3/4	-1/4	0	13/4
0	-1	1	0	-1/2	1/2	0	1/2
0	6	0	0	7/4	-9/4	1	13/4
0	-1	0	0	-1/4	-1/4	0	$f-15/4$

 s_1
 x_1
 x_3
 s_4

(13/4, 0, 1/2); $f = 15/4$

26.

x_1	x_2	x_3	x_4	s_1	s_2	s_3	s_4	
1	2	0	1	1	0	0	0	1
1	3	1	0	0	1	0	0	2
1	4	3	2	0	0	1	0	3
1	0	5	3	0	0	0	1	4
5	7	15	6	0	0	0	0	f

 s_1
 s_2
 s_3
 s_4

x_1	x_2	x_3	x_4	s_1	s_2	s_3	s_4	
1	0	0	9/8	5/4	0	-5/8	3/8	x_1
0	0	0	-21/16	-5/8	1	-7/16	1/16	s_2
0	1	0	-1/16	-1/8	0	5/16	-3/16	x_2
0	0	1	3/8	-1/4	0	1/8	1/8	x_3
0	0	0	-77/16	-13/8	0	-15/16	-39/16	$f - 227/16$

$(7/8, 1/16, 5/8, 0)$; $f = 227/16$

27. Let a , b , and x denote the amount of each grade of plywood to be produced. We want to maximize $P = 40a + 30b + 30x$ subject to the constraints: $2a + 5b + 10x \leq 900$, $2a + 5b + 3x \leq 400$, $4a + 2b + 2x \leq 600$, $a \geq 0$, $b \geq 0$, and $x \geq 0$. Upon writing the information as a simplex tableau and solving, we obtain

a	b	x	s_1	s_2	s_3	
2	5	10	1	0	0	900 s_1
2	5	3	0	1	0	400 s_2
4	2	2	0	0	1	600 s_3
40	30	20	0	0	0	P

a	b	x	s_1	s_2	s_3	
0	0	7	1	-1	0	500 s_1
0	1	1/2	0	1/4	-1/8	25 b
1	0	1/4	0	-1/8	5/16	275/2 a
0	0	-5	0	-5/2	-35/4	$P - 6250$

So P is maximized at $(137.5, 25, 0)$ with $P = \$6250$.

28. (a) Let x_1 , x_2 , and x_3 denote the amount of Heidelberg Sweet, Heidelberg Regular, and Deutschland Extra Dry to be produced, respectively. We want to maximize $P = x_1 + 1.2x_2 + 2x_3$ subject to the constraints: $x_1 + 2x_2 \leq 150$, $x_1 + 2x_3 \leq 150$, $2x_1 + x_2 \leq 80$, $2x_1 + 3x_2 + x_3 \leq 225$, $x_1 \geq 0$, $x_2 \geq 0$, and $x_3 \geq 0$. Upon writing the information in a simplex tableau and solving, we obtain

x_1	x_2	x_3	s_1	s_2	s_3	s_4	
1	2	0	1	0	0	0	150 s_1
1	0	2	0	1	0	0	150 s_2
2	1	0	0	0	1	0	80 s_3
2	3	1	0	0	0	1	225 s_4
1	1.2	2	0	0	0	0	P

x_1	x_2	x_3	s_1	s_2	s_3	s_4	
0	0	0	1	1/3	0	-2/3	50 s_1
0	0	1	0	4/9	-1/3	1/9	65 x_3
1	0	0	0	1/9	2/3	-2/9	20 x_1
0	1	0	0	-2/9	-1/3	4/9	40 x_2
0	0	0	0	-11/15	2/5	-8/15	$P - 198$

Hence P is maximized at $(20, 40, 65)$ with $P = \$198$. Note that we used all of the resources except 50 bushels of the Grade A grapes ($s_1 = 50$, and $s_2 = s_3 = s_4 = 0$). Hence we would want an increase in Grade B grapes, sugar, and labor to improve the company's profit.

29. Let c , v , and b denote the amount of chocolate, vanilla, and banana ice cream to be produced, respectively. We want to maximize $P = c + 0.9v + 0.95b$ subject to the constraints: $0.45c + 0.5v + 0.4b \leq 200$, $0.5c + 0.4v + 0.4b \leq 150$, $0.1c + 0.15v + 0.2b \leq 60$, $c \geq 0$, $v \geq 0$, and $b \geq 0$. Upon writing the information in a simplex tableau and solving, we obtain

c	v	b	s_1	s_2	s_3	
0.45	0.5	0.4	1	0	0	200 s_1
0.5	0.4	0.4	0	1	0	150 s_2
0.1	0.15	0.2	0	0	1	60 s_3
1	0.9	0.95	0	0	0	P

c	v	b	s_1	s_2	s_3	
-0.35	0	0	1	-2	2	20 s_1
3	1	0	0	10	-20	300 v
-1.75	0	1	0	-7.5	20	75 b
-0.0375	0	0	0	-1.875	-1	$P - 341.25$

Hence, if Kirkman makes 0 gallons of chocolate, 300 gallons of vanilla, and 75 gallons of banana, then the profit is maximized at \$341.25. As $s_1 = 20$, then 20 gallons of milk went unused.

30. Let f , s , and t denote the fraction of an hour fast walking, leisurely strolling, and talking to voters, respectively. We want to maximize $D = 3f + s$ subject to the constraints: $f + s \leq 3/4$, $f - s - t \leq 0$, $f + s + t \leq 1$, $f \geq 0$, $s \geq 0$, and $t \geq 0$. Upon writing the information in a simplex tableau and solving, we obtain

f	s	t	s_1	s_2	s_3	
1	1	1	1	0	0	1
1	1	0	0	1	0	3/4
1	-1	-1	0	0	1	0
3	1	0	0	0	0	P

f	s	t	s_1	s_2	s_3	
0	0	1	1	-1	0	1/4
0	1	0	-1/2	1	-1/2	1/4
1	0	0	1/2	0	1/2	1/2
0	0	0	-1	-1	-1	$P - 1.75$

Hence, if $(f, s, t) = (1/2, 1/4, 1/4)$, then D is maximized and $D = 1.75$.

31. Let x_1 , x_2 , x_3 , and x_4 denote the amount of syrup, cream, soda water, and ice cream, respectively. We want to maximize $C = 75x_1 + 50x_2 + 40x_4$ subject to the constraints: $x_4 \leq 4$, $x_1 - x_2 \leq 1$, $x_1 + x_2 - x_3 \leq 0$, $x_1 + x_2 + x_3 + x_4 \leq 12$, $x_1 \geq 0$, $x_2 \geq 0$, $x_3 \geq 0$, and $x_4 \geq 0$. Then

x_1	x_2	x_3	x_4	s_1	s_2	s_3	s_4	
1	1	1	1	1	0	0	0	12
0	0	0	1	0	1	0	0	4
1	1	-1	0	0	0	1	0	0
1	-1	0	0	0	0	0	1	1
75	50	0	40	0	0	0	0	C

x_1	x_2	x_3	x_4	s_1	s_2	s_3	s_4	
0	1	0	0	1/4	-1/4	1/4	-1/2	3/2
0	0	0	1	0	1	0	0	4
1	0	0	0	1/4	-1/4	1/4	1/2	5/2
0	0	1	0	1/2	-1/2	-1/2	0	4
0	0	0	0	-125/4	-35/4	-125/4	-25/2	$C - 845/2$

Thus if 2.5 oz of syrup, 1.5 oz of cream, 4 oz of soda water, and 4 oz of ice cream are used, then the number of calories is maximized at 422.5.

32. Let x_1 , x_2 , and x_3 denote the amount of money invested in stocks, bonds, and a savings account, respectively. We want to maximize $P = 0.08x_1 + 0.07x_2 + 0.05x_3$ subject to the constraints: $x_1 + x_2 + x_3 \leq 10,000$, $x_1 - 0.5x_2 \leq 0$, $x_1 - x_3 \leq 0$, $x_1 + x_2 \leq 8,000$, $x_1 \geq 0$, $x_2 \geq 0$, and $x_3 \geq 0$. Then

x_1	x_2	x_3	s_1	s_2	s_3	s_4	
1	1	1	1	0	0	0	10,000
1	-0.5	0	0	1	0	0	0
1	0	-1	0	0	1	0	0
1	1	0	0	0	0	1	8,000
0.08	0.07	0.05	0	0	0	0	P

x_1	x_2	x_3	s_1	s_2	s_3	s_4	
0	0	1	1	0	0	-1	2,000
1	0	0	1	0	1	-1	2,000
0	1	0	-1	0	-1	2	6,000
0	0	0	-1.5	1	-1.5	2	1,000
0	0	0	-0.006	0	-0.01	-0.01	$P - 680$

Hence if $(x_1, x_2, x_3) = (2000, 6000, 2000)$, then P is maximized and $P = \$680$.

33. Let $r, e, p,$ and n denote the number of rings, earrings, pins, and necklaces, respectively. We want to maximize $E = 50r + 80e + 25p + 200n$ subject to the constraints: $0 \leq r \leq 10, 0 \leq e \leq 10, 0 \leq p \leq 15, 0 \leq n \leq 3,$ and $2r + 2e + p + 4n \leq 40.$ Then

r	e	p	n	s_1	s_2	s_3	s_4	s_5		
2	2	1	4	1	0	0	0	0	40	s_1
1	0	0	0	0	1	0	0	0	10	s_2
0	1	0	0	0	0	1	0	0	10	s_3
0	0	1	0	0	0	0	1	0	15	s_4
0	0	0	1	0	0	0	0	1	3	s_5
50	80	25	200	0	0	0	0	0	E	

r	e	p	n	s_1	s_2	s_3	s_4	s_5		
0	0	0	1	0	0	0	0	1	3	n
1	0	0.5	0	0.5	0	-1	0	-2	4	r
0	1	0	0	0	0	1	0	0	10	e
0	0	1	0	0	0	0	1	0	15	s_4
0	0	-0.5	0	-0.5	1	1	0	2	6	s_5
0	0	0	0	-25	0	-30	0	-100	$E - 1,600$	

Thus with $(r, e, p, n) = (4, 10, 0, 3), E$ is maximized and $E = \$1600.$ Note that the jeweler can make 2 pins instead of a ring, with the same profit, so there are more solutions.

34. Using the same notation as in #29 of Application Section 1.2, we have

x_1	x_2	x_3	s_1	s_2	s_3		
1/2	1/3	0	1	0	0	10,000	s_1
1/2	1/3	1/2	0	1	0	12,000	s_2
0	1/3	1/2	0	0	1	8,000	s_3
0.3	0.4	0.5	0	0	0	P	

x_1	x_2	x_3	s_1	s_2	s_3		
1	0	0	0	2	-2	8,000	x_1
0	0	1	-2	2	0	4,000	x_3
0	1	0	3	-3	3	18,000	x_2
0	0	0	-0.2	-0.4	-0.6	$P - 11,600$	

As before, $(x_1, x_2, x_3) = (8000, 18000, 4000)$ and $P = \$11600.$

35. Using the same notation as in #28 of Application Section 1.2, we have

x_1	x_2	x_3	s_1		
0.5	1	2	1	80	s_1
100	150	200	0	P	

 \rightarrow

x_1	x_2	x_3	s_1		
1	2	4	2	160	x_1
0	-50	-200	-200	$P - 16,000$	

and

x_1	x_2	x_3	s_1		
0.5	1	2	1	80	s_1
1	1	1	0	N	

 \rightarrow

x_1	x_2	x_3	s_1		
1	2	4	2	160	x_1
0	-1	-3	-2	$N - 160$	

Hence with $(x_1, x_2, x_3) = (160, 0, 0),$ both P and N are maximized, $P = \$16000,$ and $N = \$160.$

36. Note: See Application Section 1.5 for information on the method used to solve this problem. From problem 21, we want to minimize $g = 0.5y_1 + y_2$ subject to the constraints: $0.9y_1 + 0.6y_2 \geq 2, 0.1y_1 + 0.4y_2 \geq 1, y_1 \geq 0,$ and $y_2 \geq 0.$ The dual problem is to maximize $f = 2x_1 + x_2$ subject to the constraints: $0.9x_1 + 0.1x_2 \leq 0.5, 0.6x_1 + 0.4x_2 \leq 1, x_1 \geq 0,$ and $x_2 \geq 0.$ This gives

x_1	x_2	s_1	s_2		
0.9	0.1	1	0	0.5	s_1
0.6	0.4	0	1	1	s_2
2	1	0	0	f	

 \rightarrow

x_1	x_2	s_1	s_2		
1	0	4/3	-1/3	1/3	x_1
0	1	-2	3	0	x_2
0	0	-2/3	-7/3	$f - 8/3$	

Thus with $2/3$ lb of Food I and $7/3$ lb of Food II, the cost is minimized at $\$8.9 \approx 89$ cents per pound.

37. Using the notation from problem 22, we have

x	y	s_1	s_2	s_3	s_4		
1	1	1	0	0	0	150	s_1
4	8	0	1	0	0	800	s_2
1	0	0	0	1	0	125	s_3
0	1	0	0	0	1	75	s_4
0.5	0.75	0	0	0	0	P	

x	y	s_1	s_2	s_3	s_4		
0	1	-1	0.25	0	0	50	y
0	0	-2	0.25	1	0	25	s_3
1	0	2	-0.25	0	0	100	x
0	0	1	-0.25	0	1	25	s_4
0	0	-0.25	-0.0625	0	0	$P - 87.5$	

Thus with 100 regular pizzas and 50 super deluxe pizzas, the profit is maximized at $\$87.50$.

38. Note: See Application Section 1.5 for information on the method used to solve this problem. From problem 23, we want to minimize $E = 3y_1 + 2y_2$ subject to the constraints: $5y_1 + y_2 \geq 10$, $2y_1 + 2y_2 \geq 12$, $y_1 + 4y_2 \geq 12$, $y_1 \geq 0$, and $y_2 \geq 0$. The dual problem is to maximize $f = 10x_1 + 12x_2 + 12x_3$ subject to the constraints: $5x_1 + 2x_2 + x_3 \leq 3$, $x_1 + 2x_2 + 4x_3 \leq 2$, $x_1 \geq 0$, $x_2 \geq 0$, and $x_3 \geq 0$. Then

x_1	x_2	x_3	s_1	s_2		x_1	x_2	x_3	s_1	s_2		
5	2	1	1	0	3	1	0	-3/4	1/4	-1/4	1/4	x_1
1	2	4	0	1	2	0	1	-19/8	-1/8	5/8	7/8	x_2
10	12	12	0	0	f	0	0	-9	-1	-5	$f - 13$	

Hence if the predator catches 1 of species I and 5 of species II, then the energy will be minimized at 13 units.

Application 1.5

1. $\begin{pmatrix} -1 & 6 \\ 4 & 5 \end{pmatrix}$

2. $\begin{pmatrix} 3 & 1 \\ 0 & 2 \end{pmatrix}$

3. $\begin{pmatrix} 2 & -1 & 1 \\ 3 & 2 & 4 \end{pmatrix}$

4. $\begin{pmatrix} 2 & 1 \\ -1 & 5 \\ 0 & 6 \end{pmatrix}$

5. $\begin{pmatrix} 1 & -1 & 1 \\ 2 & 0 & 5 \\ 3 & 4 & 5 \end{pmatrix}$

6. $\begin{pmatrix} 1 & 2 & 3 \\ 2 & 4 & -5 \\ 3 & -5 & 7 \end{pmatrix}$

7. $\begin{pmatrix} 1 & 0 \\ 0 & 1 \\ 1 & 0 \\ 0 & 1 \end{pmatrix}$

8. $\begin{pmatrix} 2 & 2 & 1 & 1 \\ -1 & 4 & 6 & 5 \end{pmatrix}$

9. $\begin{pmatrix} a & d & g \\ b & e & h \\ c & f & j \end{pmatrix}$

10. $\begin{pmatrix} 0 & 0 \\ 0 & 0 \\ 0 & 0 \end{pmatrix}$

11.

Minimize $g = 5y_1 + 7y_2 + y_3$
 subject to
 $y_1 + 3y_2 + y_3 \geq 2$
 $2y_1 + 2y_2 + y_3 \geq 5$
 $y_1, y_2, y_3 \geq 0$

13.

Maximize $f = x_1 + x_2$
 subject to
 $2x_1 + x_2 \leq 2$
 $x_1 + 2x_2 \leq 3$
 $x_1, x_2 \geq 0$

15.

Minimize $g = 5y_1 + 6y_2$
 subject to
 $y_1 + 2y_2 \geq 1$
 $y_1 + y_2 \geq 1$
 $y_1 + 3y_2 \geq 1$
 $y_1, y_2 \geq 0$

17.

Maximize $f = 13x_1 + 21x_2 + 11x_3$
 subject to
 $x_1 + 4x_2 - 3x_3 \leq 2$
 $2x_1 + x_2 - x_3 \leq 5$
 $x_1 + 2x_2 + 4x_3 \leq 3$
 $x_1, x_2, x_3 \geq 0$

12.

Minimize $g = 5y_1 + 6y_2$
 subject to
 $y_1 + 3y_2 \geq 4$
 $-1y_1 - 2y_2 \geq 3$
 $y_1, y_2 \geq 0$

14.

Maximize $f = x_1 + x_2 + 3x_3$
 subject to
 $2x_1 + x_2 \leq 5$
 $x_1 + 2x_2 + x_3 \leq 3$
 $x_1, x_2, x_3 \geq 0$

16.

Minimize $g = 5y_1 + 6y_2 + 7y_3$
 subject to
 $y_1 - y_2 + 2y_3 \geq 2$
 $-y_1 + y_2 - y_3 \geq 8$
 $-y_1 + 2y_2 + y_3 \geq 3$
 $y_1 - 1, y_2, y_3 \geq 0$

18.

Minimize $g = 8y_1 + 6y_2 + 25y_3$
 subject to
 $2y_1 + 4y_2 + 8y_3 \geq 4$
 $3y_1 + y_2 + 7y_3 \geq -1$
 $y_1 + 2y_2 + 4y_3 \geq 9$
 $y_1, y_2, y_3 \geq 0$

19.

Minimize $g = 12y_1$
 subject to
 $y_1 \geq 1$
 $2y_1 \geq 2$
 $3y_1 \geq -1$
 $4y_1 \geq 5$
 $y_1 \geq 0$

20.

Maximize $f = 10x_1 + 14x_2 + 5x_3$
 subject to
 $x_1 + 2x_2 + 5x_3 + 2x_4 \leq 3$
 $x_1 - x_2 - 8x_3 - x_4 \leq 1$
 $x_1 + x_2 - 3x_3 - 5x_4 \leq 5$
 $x_1 + 2x_2 + 3x_3 + 3x_4 \leq 12$
 $x_1, x_2, x_3, x_4 \geq 0$

21.

x_1	x_2	s_1	s_2	
2	1	1	0	2
1	2	0	1	3
1	1	0	0	f

s_1
 s_2 →

x_1	x_2	s_1	s_2	
1	1/2	1/2	0	1
0	3/2	-1/2	1	2
0	1/2	-1/2	0	$f-1$

x_1
 s_2

x_1	x_2	s_1	s_2	
1	0	2/3	-1/3	1/3
0	1	-1/3	2/3	4/3
0	0	-1/3	-1/3	$f-5/3$

→ x_1
 x_2

$g = 5/3$ at $(1/3, 1/3)$.

22.

x_1	x_2	x_3	s_1	s_2	
2	1	1	1	0	5
1	2	1	0	1	3
1	1	3	0	0	f

s_1
 s_2 →

x_1	x_2	x_3	s_1	s_2	
1	-1	0	1	-1	2
1	2	1	0	1	3
-2	-5	0	0	-3	$f-9$

s_1
 x_3

$g = 9$ at $(0, 3)$.

23.

x_1	x_2	x_3	s_1	s_2	s_3	
1	4	-3	1	0	0	2
2	1	-1	0	1	0	5
1	2	4	0	0	1	3
13	21	11	0	0	0	f

s_1
 s_2
 s_3 →

x_1	x_2	x_3	s_1	s_2	s_3	
1	4	-3	1	0	0	2
0	-7	5	-2	1	0	1
0	-2	7	-1	0	1	1
0	-31	50	-13	0	0	$f-26$

x_1
 s_2
 s_3

x_1	x_2	x_3	s_1	s_2	s_3	
1	22/7	0	4/7	0	3/7	17/7
0	-39/7	0	-9/7	1	-5/7	2/7
0	-2/7	1	-1/7	0	1/7	1/7
0	-117/7	0	-41/7	0	-50/7	$f-232/7$

→ x_1
 s_2
 x_3

$g = 232/7$ at $(41/7, 0, 50/7)$.

24.

x_1	x_2	x_3	x_4	s_1	s_2	s_3	s_4	
1	2	5	2	1	0	0	0	3
1	-1	-8	-4	0	1	0	0	1
1	1	-3	-5	0	0	1	0	5
1	2	3	3	0	0	0	1	12
10	14	5	0	0	0	0	0	f

s_1
 s_2
 s_3
 s_4

x_1	x_2	x_3	x_4	s_1	s_2	s_3	s_4	
1/2	1	5/2	1	1/2	0	0	0	3/2
3/2	0	-11/2	-3	1/2	1	0	0	5/2
1/2	0	-11/2	-6	-1/2	0	1	0	7/2
0	0	-2	1	-1	0	0	1	9
3	0	-30	-14	-7	0	0	0	$f-21$

→ x_2
 s_2
 s_3
 s_4

x_1	x_2	x_3	x_4	s_1	s_2	s_3	s_4	
0	1	13/3	2	1/3	-1/3	0	0	x_2
1	0	-11/3	-2	1/3	2/3	0	0	x_1
0	0	-11/3	-5	-2/3	-1/3	1	0	s_3
0	0	-2	1	-1	0	0	1	s_4
0	0	-19	-8	-8	-2	0	0	$f - 26$

$g = 26$ at $(8, 2, 0, 0)$.

25. Let $y_1 =$ lbs. of Food I and $y_2 =$ lbs. of Food II.

Minimize $g = 0.5y_1 + y_2$ subject to $0.9y_1 + 0.6y_2 \geq 2$ $0.1y_1 + 0.4y_2 \geq 1$ $y_1, y_2 \geq 0$	Dual problem: Maximize $f = 2x_1 + x_2$ subject to $0.9x_1 + 0.1x_2 \leq 0.5$ $0.6x_1 + 0.4x_2 \leq 1$ $x_1, x_2 \geq 0$
-------------------------------------------------------------------------------------------------------------------------------	---------------------------------------------------------------------------------------------------------------------------------------------

x_1	x_2	s_1	s_2	
0.9	0.1	1	0	0.5
0.6	0.4	0	1	1
2	1	0	0	f

 $\xrightarrow{s_1, s_2}$

x_1	x_2	s_1	s_2	
1	1/9	10/9	0	5/9
0	1/3	-2/3	1	2/3
0	7/9	-20/9	0	$f - 10/9$

x_1	x_2	s_1	s_2	
1	0	4/3	-1/3	1/3
0	1	-2	3	2
0	0	-2/3	-7/3	$f - 8/3$

Then $y_1 = 2/3$ lb. and $y_2 = 7/3$ lb. Cost per lb. = $(\$8/3)/3\text{lb.} = \$0.89/\text{lb.}$

26.

x_1	x_2	s_1	s_2	s_3	
0.9	0.1	1	0	0	0.5
0.6	0.4	0	1	0	1
0.3	0.7	0	0	1	2
2	1	0	0	0	f

 $\xrightarrow{s_1, s_2, s_3}$

x_1	x_2	s_1	s_2	s_3	
1	1/9	10/9	0	0	5/9
0	1/3	-2/3	1	0	2/3
0	2/3	-1/3	0	1	11/6
0	7/9	-20/9	0	0	$f - 10/9$

x_1	x_2	s_1	s_2	s_3	
1	0	4/3	-1/3	0	1/3
0	1	-2	3	0	2
0	0	1	-2/3	1	1/2
0	0	-2/3	-7/3	0	$f - 8/3$

Then $y_1 = 2/3$ lb., $y_2 = 7/3$ lb. and $y_3 = 0$ lb. Cost per lb. = $(\$8/3)/3$ lb. = $\$0.89/\text{lb.}$

27. Let $y_1 =$ lbs. of chemical 1, $y_2 =$ lbs. of chemical 2 and $y_3 =$ lbs. of chemical 3.

Minimize $g = 20y_1 + 15y_2 + 5y_3$ subject to $y_1 \geq 20$ $y_2 - y_3 \geq 0$ $y_1 + y_2 + y_3 \geq 100$ $y_1, y_2, y_3 \geq 0$	Dual problem: Maximize $f = 20x_1 + 100x_2$
-----------------------------------------------------------------------------------------------------------------------------------------------	------------------------------------------------

Since $y_3 = 100 - y_1 - y_2$, $g = 500 + 15y_1 + 10y_2$. To minimize g , we then would minimize $15y_1 + 10y_2$. Then we have:

Minimize $g = 15y_1 + 10y_2$	Dual problem: Maximize $f = 20x_1 + 100x_2$
---------------------------------	------------------------------------------------

subject to

$$\begin{aligned} y_1 &\geq 20 \\ y_1 + 2y_2 &\geq 100 \\ y_1, y_2 &\geq 0 \end{aligned}$$

subject to

$$\begin{aligned} x_1 + x_2 &\leq 15 \\ 2x_2 &\leq 10 \\ x_1, x_2 &\geq 0 \end{aligned}$$

x_1	x_2	s_1	s_2	
1	1	1	0	15
0	2	0	1	10
20	100	0	0	f

 s_1
 s_2 →

x_1	x_2	s_1	s_2	
1	1	1	0	15
0	2	0	1	10
0	80	-20	0	$f - 300$

 x_1
 s_2

→

x_1	x_2	s_1	s_2	
1	0	1	-1/2	10
0	1	0	1/2	5
0	0	-20	-40	$f - 700$

 x_1
 x_2

Then $y_1 = 20$ lbs., $y_2 = 40$ lbs. and therefore $y_3 = 40$ lbs. The minimized cost is \$1200.

28. Let $y_1 =$ hrs. for jogging, $y_2 =$ hrs. for bicycling and $y_3 =$ hrs. for swimming.

Minimize
 $g = y_1 + y_2 + y_3$
 subject to

Dual problem: Maximize
 $f = 2x_1 + 3000x_3$
 subject to

$$\begin{aligned} -y_1 + y_2 - y_3 &\geq 0 \\ y_3 &\geq 2 \\ 600y_1 + 300y_2 + 300y_3 &\geq 3000 \\ y_1, y_2, y_3 &\geq 0 \end{aligned}$$

$$\begin{aligned} -x_1 + 600x_3 &\leq 1 \\ x_1 + 300x_3 &\leq 1 \\ -x_1 + x_2 + 300x_3 &\leq 1 \\ x_1, x_2, x_3 &\geq 0 \end{aligned}$$

x_1	x_2	x_3	s_1	s_2	s_3	
-1	0	600	1	0	0	1
1	0	300	0	1	0	1
-1	1	300	0	0	1	1
0	2	3000	0	0	0	f

 s_1
 s_2
 s_3 →

x_1	x_2	x_3	s_1	s_2	s_3	
-1/600	0	1	1/600	0	0	1/600
3/2	0	0	-1/2	1	0	1/2
-1/2	1	0	-1/2	0	1	1/2
5	2	0	-5	0	0	$f - 5$

 x_3
 s_2
 s_3

→

x_1	x_2	x_3	s_1	s_2	s_3	
-1/600	0	1	1/600	0	0	1/600
3/2	0	0	-1/2	1	0	1/2
-1/2	1	0	-1/2	0	1	1/2
6	0	0	-4	0	-2	$f - 6$

 x_3
 s_2
 x_2

→

x_1	x_2	x_3	s_1	s_2	s_3	
0	0	1	1/450	-1/900	0	1/900
1	0	0	-1/3	2/3	0	1/3
0	1	0	-2/3	1/3	1	2/3
0	0	0	-2	-4	-2	$f - 8$

 x_3
 x_1
 x_2

Then $y_1 = 2$, $y_2 = 4$ and $y_3 = 2$. The minimized time is 8 hours.

Application 1.6

1. (a)

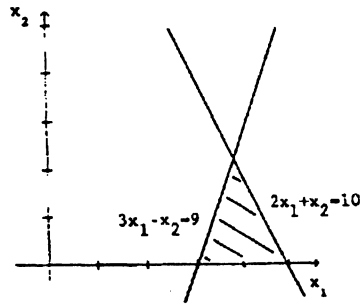

$(19/5, 12/5); f = 11$

(b)

x_1	x_2	s_1	s_2	
2	1	1	0	10
-3	1	0	1	-9
1	3	0	0	f

s_1
 s_2 →

x_1	x_2	s_1	s_2	
0	5/3	1	2/3	4
1	-1/3	0	-1/3	3
0	10/3	0	1/3	$f - 3$

s_1
 x_1

→

x_1	x_2	s_1	s_2	
0	1	3/5	2/5	12/5
1	0	1/5	-1/5	19/5
0	0	-2	-1	$f - 11$

x_2
 x_1

$(19/5, 12/5); f = 11.$

2. (a)

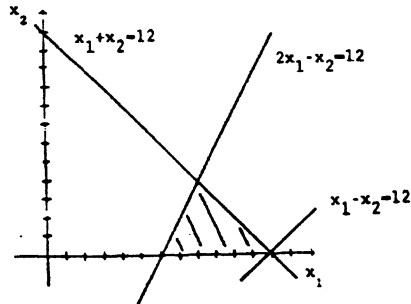

$(8, 4); f = 36$

(b)

x_1	x_2	s_1	s_2	s_3	
1	-1	1	0	0	12
1	1	0	1	0	12
-2	1	0	0	1	-12
2	5	0	0	0	f

s_1
 s_2
 s_3 →

x_1	x_2	s_1	s_2	s_3	
0	-1/2	1	0	1/2	6
0	3/2	0	1	1/2	6
1	-1/2	0	0	-1/2	6
0	6	0	0	1	$f - 12$

s_1
 s_2
 x_1

→

x_1	x_2	s_1	s_2	s_3	
0	0	1	1/3	2/3	8
0	1	0	2/3	1/3	4
1	0	0	1/3	-1/3	8
0	0	0	-4	-1	$f - 36$

s_1
 x_2
 x_1

$(8, 4); f = 36.$

3.

x_1	x_2	x_3	s_1	s_2	s_3	
1	1	2	1	0	0	5
1	-1	1	0	1	0	3
-1	0	1	0	0	1	-1
1	1	1	0	0	0	f

s_1
 s_2
 s_3

→

x_1	x_2	x_3	s_1	s_2	s_3	
0	1	3	1	0	1	4
0	-1	2	0	1	1	2
1	0	-1	0	0	-1	1
0	1	2	0	0	1	$f-1$

s_1
 s_2
 x_1

x_1	x_2	x_3	s_1	s_2	s_3	
0	1	3	1	0	1	4
0	0	-5	1	1	2	6
1	0	-1	0	0	-1	1
0	0	-1	-1	0	0	$f-5$

x_2
 s_2
 x_1

(1, 4, 0); $f = 5$.

4. The dual problem is to maximize $f = x_1 + 3x_2$ subject to the constraints: $2x_1 + x_2 \leq 10$, $-3x_1 + x_2 \leq -9$, $x_1 \geq 0$, and $x_2 \geq 0$. By problem 1, g is minimized at (2, 1) and $g = 11$.
5. The dual problem is to maximize $f = 2x_1 + x_2$ subject to the constraints: $x_1 - x_2 \leq 12$, $x_1 + x_2 \leq 12$, $-2x_1 + x_2 \leq -12$, $x_1 \geq 0$, $x_2 \geq 0$, and $x_3 \geq 0$. By problem 2, $g = 36$ at (0, 4, 1).

6.

x_1	x_2	x_3	s_1	s_2	s_3	
4	3	-2	1	0	0	2
1	5	1	0	1	0	3
-2	5	-1	0	0	1	-4
1	3	4	0	0	0	f

s_1
 s_2
 s_3

x_1	x_2	x_3	s_1	s_2	s_3	
0	-3.25	1	-0.25	0	-0.5	1.5
0	9.125	0	0.125	1	0.75	0.25
1	-0.875	0	0.125	0	-0.25	1.25
0	16.875	0	0.875	0	2.25	$f-7.25$

x_3
 s_2
 x_1

x_1	x_2	x_3	s_1	s_2	s_3	
0	15	1	0	2	1	2
0	73	0	1	8	6	2
1	-10	0	0	-1	-1	1
0	-47	0	0	-7	-3	$f-9$

x_3
 s_1
 x_1

(1, 0, 2); $f = 9$.

Review Exercises for Application 1

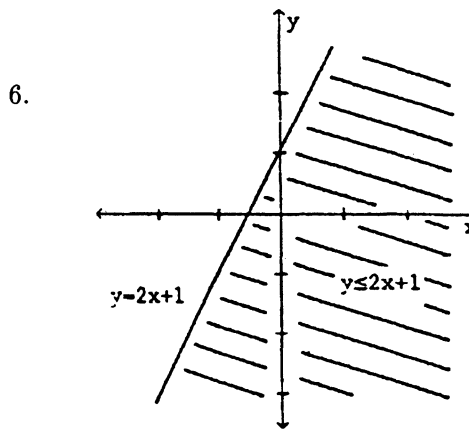
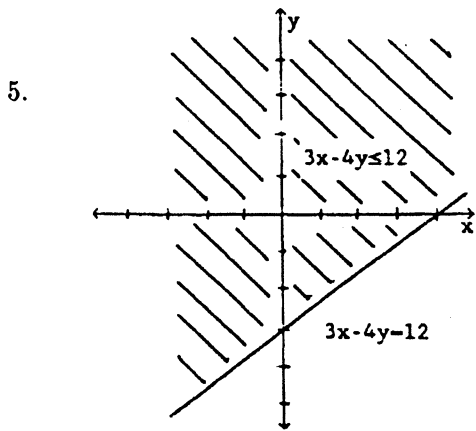
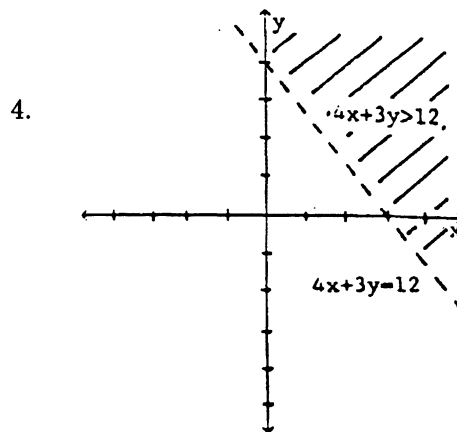
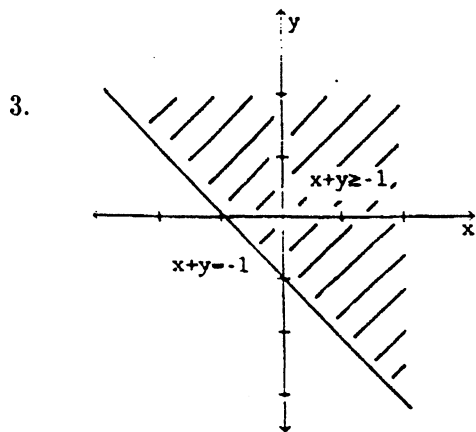
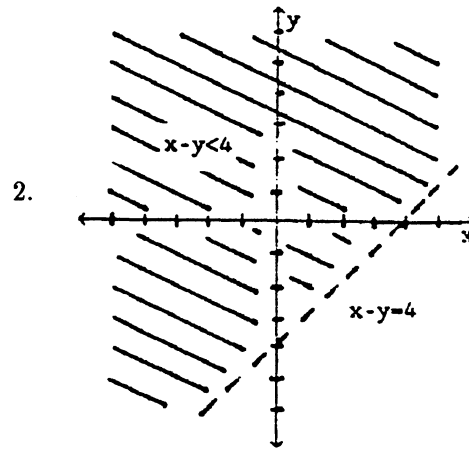
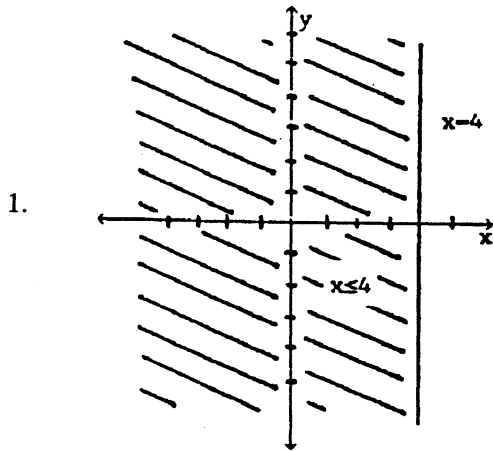

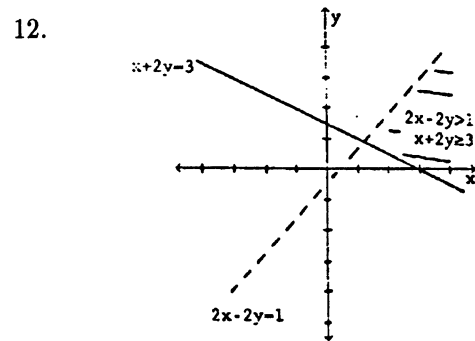
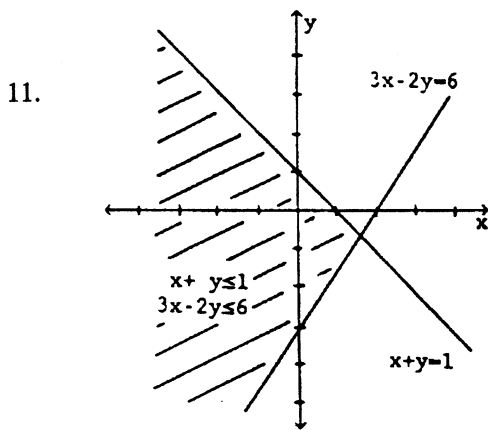
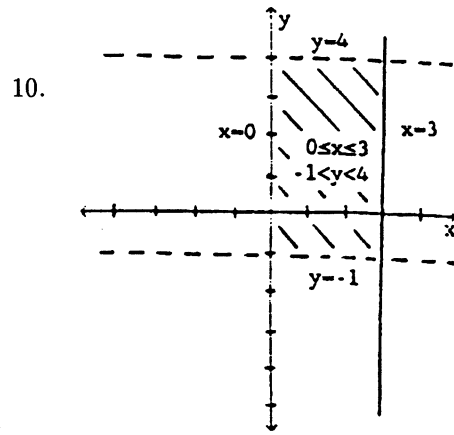
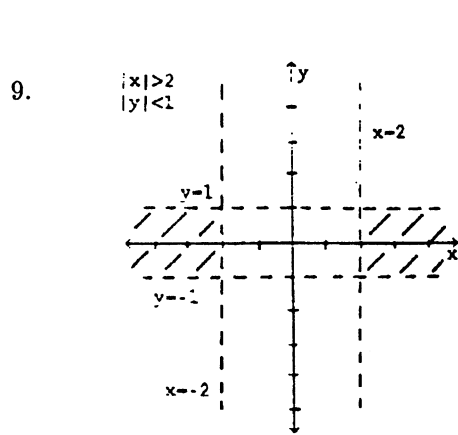
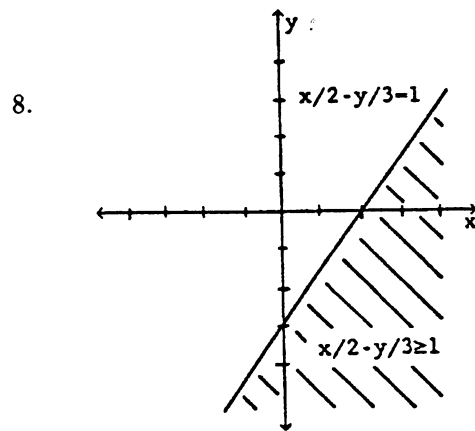
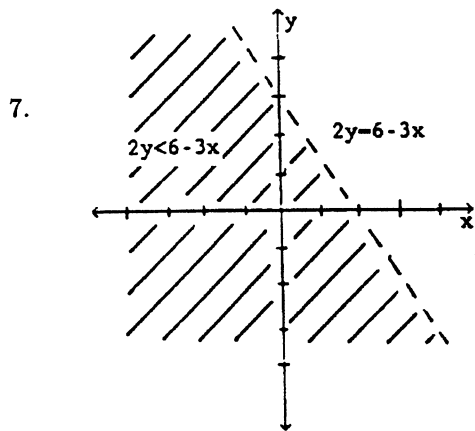

13.

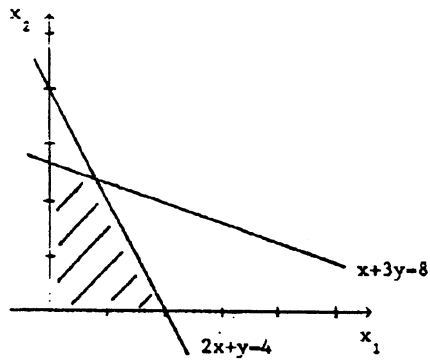

$(4/5, 12/5); f = 68/5$

14.

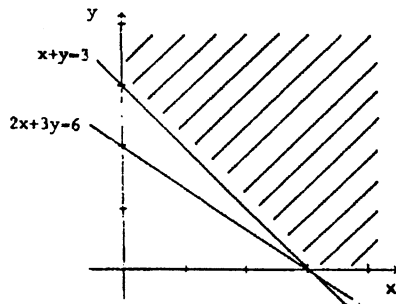

$(3, 0); g = 3$

15.

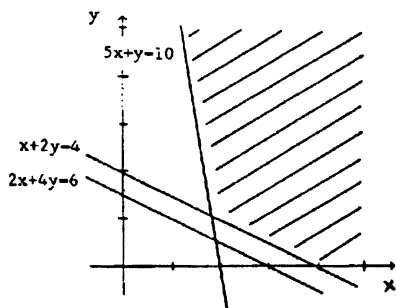

$(16/9, 10/9); g = 68/9$

16.

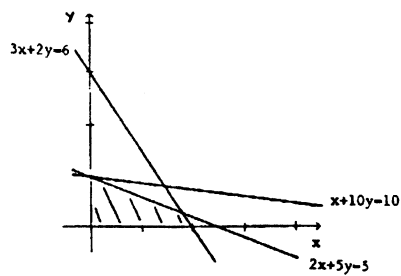

$(20/11, 3/11); f = 109/11$

17. Unbounded. (No maximum)

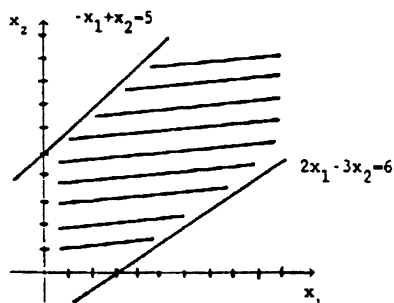

18. The corner points are $(0, 3)$, $(3, 0)$, $(0, 7)$, $(7, 0)$, and $(3/4, 3/4)$. $f = 27/4$ at $(3/4, 3/4)$.
19. Minimize $g = 5y_1 + 6y_2$ subject to the constraints: $-y_1 + 2y_2 \geq 2$, $y_1 - 3y_2 \geq 3$, $y_1 \geq 0$, and $y_2 \geq 0$.
20. Minimize $g = 3y_1 + 3y_2 + 7y_3$ subject to the constraints: $y_1 + 3y_2 + y_3 \geq 4$, $3y_1 + y_2 + y_3 \geq 5$, $y_1 \geq 0$, $y_2 \geq 0$, and $y_3 \geq 0$.

21.

x_1	x_2	x_3	s_1	s_2	s_3		
1	2	1	1	0	0	13	s_1
3	4	-2	0	1	0	6	s_2
-4	6	3	0	0	1	11	s_3
2	1	4	0	0	0	f	

22. a_{12} or a_{22} or a_{33}
23. Minimize $g = 13y_1 + 6y_2 + 11y_3$ subject to the constraints: $y_1 + 3y_2 - 4y_3 \geq 2$, $2y_1 + 4y_2 + 6y_3 \geq 1$, $y_1 - 2y_2 + 3y_3 \geq 4$, $y_1 \geq 0$, $y_2 \geq 0$, and $y_3 \geq 0$.

24.

x_1	x_2	x_3	s_1	s_2	s_3		
0	2	1	4/7	0	1/7	9	x_3
1	0	0	3/7	0	-1/7	4	x_1
0	8	0	-1/7	1	5/7	12	s_2
0	-7	0	-22/7	0	-2/7	$f - 44$	

25. $(4, 0, 9)$; $f = 44$; $(22/7, 0, 2/7)$; $g = 44$
26. Maximize $f = 4x_1 + 12x_2 + 8x_3$ subject to the constraints: $3x_1 - 6x_2 + 9x_3 \leq 3$, $2x_1 + 8x_2 - 10x_3 \leq -1$, $x_1 + 3x_2 + 5x_3 \leq 4$, $x_1 \geq 0$, $x_2 \geq 0$, and $x_3 \geq 0$.

27.

x_1	x_2	x_3	s_1	s_2	s_3		
3	-6	9	1	0	0	3	s_1
2	8	-10	0	1	0	-1	s_2
1	3	5	0	0	1	4	s_3
4	12	8	0	0	0	f	

28.

x_1	x_2	x_3	s_1	s_2	s_3		
1	0	0	35/156	19/104	-1/26	35/104	x_1
0	0	1	-1/156	-5/104	3/26	51/104	x_3
0	1	0	-5/78	1/52	2/13	21/52	x_2
0	0	0	-1/13	-15/26	-34/13	$f - 263/26$	

29. $(1/13, 15/26, 34/13)$; $g = 263/26$.

30.

x_1	x_2	x_3	s_1	s_2	s_3	
1	2	1	1	0	0	5
-1	1	1	0	1	0	3
0	-1	1	0	0	1	1
1	1	1	0	0	0	f

 s_1
 s_2 →

x_1	x_2	x_3	s_1	s_2	s_3	
1	2	1	1	0	0	5
0	3	2	1	1	0	8
0	-1	1	0	0	1	1
0	-1	0	-1	0	0	$f-5$

 s_1
 s_2
 s_3

(5, 0, 0); $f = 5$.

31. The dual problem is to maximize $f = 2x_1 + 5x_2$ subject to the constraints: $x_1 + x_2 \leq 4$, $-2x_1 + x_2 \leq -4$, $x_1 - x_2 \leq 4$, $x_1 \geq 0$, $x_2 \geq 0$, and $x_3 \geq 0$. Then

x_1	x_2	s_1	s_2	s_3	
1	1	1	0	0	4
-2	1	0	1	0	-4
1	-1	0	0	1	4
2	5	0	0	0	f

 s_1
 s_2 →

x_1	x_2	s_1	s_2	s_3	
0	1	2/3	1/3	0	4/3
1	0	1/3	-1/3	0	8/3
0	0	1/3	2/3	1	8/3
0	0	-4	-1	0	$f-12$

 x_2
 x_1
 s_3

So $g = 12$ at (4, 1, 0).

32.

x_1	x_2	x_3	s_1	s_2	
1	2	3	1	0	6
1	1	2	0	1	4
4	2	5	0	0	f

 s_1
 s_2 →

x_1	x_2	x_3	s_1	s_2	
0	1	1	1	-1	2
1	1	2	0	1	4
0	-2	-3	0	-4	$f-16$

 s_1
 x_1

(4, 0, 0); $f = 16$.

33.

x_1	x_2	x_3	s_1	s_2	s_3	
3	1	2	1	0	0	8
1	2	4	0	1	0	6
7	4	8	0	0	1	25
1	-1	1	0	0	0	f

 s_1
 s_2 →

x_1	x_2	x_3	s_1	s_2	s_3	
1	0	0	2/5	-1/5	0	2
0	1/2	1	-1/10	3/10	0	1
0	0	0	-2	-1	1	3
0	-3/2	0	-3/10	-1/10	0	$f-3$

 x_1
 x_3
 s_3

(2, 0, 1); $f = 3$.

34. In the dual problem we have $x_1 + 3x_2 + x_3 \leq -1$, and hence the problem is infeasible.

35. The dual problem is to maximize $f = 3x_1 + 6x_2$ subject to the constraints: $x_1 + 2x_2 \leq 2$, $x_1 + 3x_2 \leq 1$, $3x_1 + x_2 \leq 3$, $x_1 \geq 0$, and $x_2 \geq 0$. Then

x_1	x_2	s_1	s_2	s_3	
1	2	1	0	0	2
1	3	0	1	0	1
3	1	0	0	1	3
3	6	0	0	0	f

 s_1
 s_2 →

x_1	x_2	s_1	s_2	s_3	
0	-1	1	-1	0	1
1	3	0	1	0	1
0	-8	0	-3	1	0
0	-3	0	-3	0	$f-3$

 s_1
 x_1
 s_3

Hence $g = 3$ at (1, 0, 0). Note that $g = 3$ at (0, 15/8, 3/8), so more solutions exist.

36. (a) Let x_1 and x_2 denote the number of cakes and cookies, respectively. We want to maximize $E = 10x_1 + 3x_2$ subject to the constraints: $2.5x_1 + x_2 \leq 70$, $2x_1 + 0.5x_2 \leq 50$, $x_1 \geq 0$, and $x_2 \geq 0$. Then

(b)

x_1	x_2	s_1	s_2	
5/2	1	1	0	70
2	1/2	0	1	50
10	3	0	0	E

 s_1
 s_2 →

x_1	x_2	s_1	s_2	
0	1	8/3	-10/3	20
1	0	-2/3	4/3	20
0	0	-4/3	-10/3	$E-260$

 x_2
 x_1

So $x_1 = 20$ cakes, $x_2 = 20$ cookies, and $E = \$260$.

37. Letting x_1 and x_2 denote the number of cakes and cookies respectively, we want to minimize $C = 1.425x_1 + 0.45x_2$ subject to the constraints: $2.5x_1 + 2x_2 \geq 200$, $2x_1 + 0.5x_2 \geq 120$, $x_1 \geq 0$, and $x_2 \geq 0$. The dual problem is to maximize $f = 200y_1 + 120y_2$ subject to $2.5y_1 + 2y_2 \leq 1.425$, $y_1 + 0.5y_2 \leq 0.45$, $y_1 \geq 0$, and $y_2 \geq 0$. Then

y_1	y_2	s_1	s_2	
2.5	2	1	0	1.425
1	0.5	0	1	0.45
200	120	0	0	f

 $\xrightarrow{\begin{matrix} s_1 \\ s_2 \end{matrix}}$

y_1	y_2	s_1	s_2	
0	1	$4/3$	$-10/3$	$2/5$
1	0	$-2/3$	$8/3$	$1/4$
0	0	$-80/3$	$-400/3$	$f - 98$

 $\begin{matrix} y_2 \\ y_1 \end{matrix}$

So $x_1 = 80/3$ cakes, $x_2 = 400/3$ cookies, and $C = \$98$.

38. Let b and c denote the number of acres of soybeans and corn, respectively. We want to maximize $P = 100b + 200c$ subject to $b + c \leq 500$, $2b + 6c \leq 1,200$, $0 \leq b \leq 200$, and $c \geq 0$. Then

b	c	s_1	s_2	s_3	
1	1	1	0	0	500
1	0	0	1	0	200
2	6	0	0	1	1,200
100	200	0	0	0	P

 $\xrightarrow{\begin{matrix} s_1 \\ s_2 \\ s_3 \end{matrix}}$

b	c	s_1	s_2	s_3	
0	0	1	$-2/3$	$-1/6$	$500/3$
1	0	0	1	0	200
0	1	0	$-1/3$	$1/6$	$400/3$
0	0	0	$-100/3$	$-100/3$	$P - 140,000/3$

 $\begin{matrix} s_1 \\ b \\ c \end{matrix}$

Hence $b = 200$ acres of soybeans, $c = 400/3$ acres of corn, and $P = \$140,000/3 \approx \$46,666.67$.

39. $\begin{matrix} x_1 & x_2 & s_1 & s_2 & s_3 & \\ \hline 1 & -2 & 1 & 0 & 0 & 6 \\ 1 & 1 & 0 & 1 & 0 & 8 \\ -2 & 1 & 0 & 0 & 1 & -8 \\ \hline 3 & 2 & 0 & 0 & 0 & f \end{matrix} \xrightarrow{\begin{matrix} s_1 \\ s_2 \\ s_3 \end{matrix}} \begin{matrix} x_1 & x_2 & s_1 & s_2 & s_3 & \\ \hline 0 & 0 & 1 & 1 & 1 & 6 \\ 0 & 1 & -1/3 & 1/3 & 0 & 2/3 \\ 1 & 0 & 1/3 & 2/3 & 0 & 22/3 \\ \hline 0 & 0 & -1/3 & -8/3 & 0 & f - 70/3 \end{matrix} \begin{matrix} s_3 \\ x_2 \\ x_1 \end{matrix}$

$(22/3, 2/3)$; $f = 70/3$

40. $\begin{matrix} y_1 & y_2 & s_1 & s_2 & \\ \hline 3 & -2 & 1 & 0 & 1 \\ -1 & -1 & 0 & 1 & -4 \\ \hline 8 & 3 & 0 & 0 & g \end{matrix} \xrightarrow{\begin{matrix} s_1 \\ s_2 \end{matrix}} \begin{matrix} y_1 & y_2 & s_1 & s_2 & \\ \hline 1 & 0 & 1/5 & -2/5 & 9/5 \\ 0 & 1 & -1/5 & -3/5 & 11/5 \\ \hline 0 & 0 & -1 & 5 & g - 21 \end{matrix} \begin{matrix} s_2 \\ y_1 \end{matrix}$

Unbounded (No maximum)

Application 2. Markov Chains and Game Theory**Application 2.1**

1. yes
6. yes

2. no
7. yes

3. no
8. no

4. yes
9. yes

5. no
10. no

11. Strictly determined; $\mathbf{p} = (0 \ 1 \ 0)$, $\mathbf{q} = \begin{pmatrix} 1 \\ 0 \\ 0 \end{pmatrix}$.

12. Strictly determined; $\mathbf{p} = (0 \ 1 \ 0)$, $\mathbf{q} = \begin{pmatrix} 1 \\ 0 \\ 0 \end{pmatrix}$.

13. Not strictly determined.

14. Strictly determined; $\mathbf{p} = (1 \ 0 \ 0)$, $\mathbf{q} = \begin{pmatrix} 0 \\ 1 \\ 0 \end{pmatrix}$

15. Strictly determined; $\mathbf{p} = (0 \ 0 \ 1)$, $\mathbf{q} = \begin{pmatrix} 1 \\ 0 \end{pmatrix}$.

16. Strictly determined; $\mathbf{p} = (0 \ 0 \ 1)$, $\mathbf{q} = \begin{pmatrix} 0 \\ 1 \\ 0 \end{pmatrix}$.

17. Not strictly determined.

18. Not strictly determined.

19. Strictly determined; $\mathbf{p} = (0 \ 1 \ 0 \ 0)$, $\mathbf{q} = \begin{pmatrix} 0 \\ 0 \\ 1 \\ 0 \end{pmatrix}$.

20. Not strictly determined.

21.
$$\begin{array}{c} \text{player C} \\ 1 \quad 2 \\ \text{player R } \begin{pmatrix} -2 & 3 \\ 3 & -4 \end{pmatrix} \end{array}; \text{ Not strictly determined.}$$

22.
$$\begin{array}{c} \text{player C} \\ 4 \quad 5 \\ \text{player R } \begin{pmatrix} -8 & 9 \\ 9 & -10 \end{pmatrix} \end{array}; \text{ Not strictly determined.}$$

23.
$$\begin{array}{c} \text{player C} \\ 1 \quad 2 \quad 3 \\ \text{player R } \begin{pmatrix} -2 & 3 & -4 \\ 3 & -4 & 5 \\ -4 & 5 & -6 \end{pmatrix} \end{array}; \text{ Not strictly determined.}$$

24.
$$\begin{array}{c} \text{player C} \\ 1 \quad 2 \quad 3 \quad 4 \quad 5 \\ \text{player R } \begin{pmatrix} -2 & 3 & -4 & 5 & -6 \\ 3 & -4 & 5 & -6 & 7 \\ -4 & 5 & -6 & 7 & -8 \\ 5 & -6 & 7 & -8 & 9 \\ -6 & 7 & -8 & 9 & -10 \end{pmatrix} \end{array}; \text{ Not strictly determined.}$$

$$25. \begin{array}{c} \text{B} \\ I \quad S \quad D \\ \text{A} \begin{array}{c} I \\ S \\ D \end{array} \begin{pmatrix} -1 & -3 & -11 \\ 4 & 0 & -5 \\ 9 & 3 & -1 \end{pmatrix} \end{array}; \text{A and B should both lower their prices.}$$

$$26. \begin{array}{c} \text{Readywear} \\ M \quad C \\ \text{Vince} \begin{array}{c} M \\ C \end{array} \begin{pmatrix} 50 & 80 \\ 20 & 50 \end{pmatrix} \end{array}; \text{Both stores should move to the mall.}$$

27. The choices given represent (R_1, R_2) ; that is, the days spent in region one is the first coordinate and

the days spent in region two is the second coordinate. The payoff matrix is

$$D \begin{array}{c} \text{R} \\ 0 \quad 1 \quad 2 \\ 1 \begin{pmatrix} 0 & -3 & -7 \\ 3 & 0 & -3 \\ 7 & 3 & 0 \end{pmatrix} \\ 2 \end{array};$$

each candidate should spend two days in the larger district.

$$28. \begin{array}{c} \text{C} \\ 2 \quad 4 \quad 7 \\ \text{R} \begin{array}{c} 2 \\ 4 \\ 7 \end{array} \begin{pmatrix} 4 & -2 & -5 \\ -2 & 8 & -3 \\ -5 & -3 & 14 \end{pmatrix} \end{array}; \text{Not strictly determined.}$$

$$29. \text{The payoff matrix is } \begin{array}{c} \text{Home} \quad \text{Not} \\ \text{S} - \text{S} \\ \text{P} - \text{P} \end{array} \begin{pmatrix} 1 & -2 \\ -1.5 & 0 \end{pmatrix}; \text{this is not strictly determined.}$$

$$30. \begin{pmatrix} 8 & 11 \\ 8 & 5 \end{pmatrix}; \text{The farmer should pick the tomatoes on August 25.}$$

31. The company should take a logical approach and the union should take a legal approach.

32. The University of Montana should use the fullback run and Montana State University should use the prevent defense against a short pass.

33. Since a_{ij} and a_{kl} are both saddle points then $a_{ij} \leq a_{il} \leq a_{kl} \Rightarrow a_{ij} \leq a_{kl}$ and $a_{ij} \geq a_{kj} \geq a_{kl} \Rightarrow a_{ij} \geq a_{kl}$. Then $a_{ij} = a_{kl}$.

Application 2.2

1. $pAq^t = p \begin{pmatrix} 9/2 \\ 15/4 \end{pmatrix} = 4$

2. $pAq^t = p \begin{pmatrix} 4 \\ 5 \end{pmatrix} = 4$

3. $pAq^t = p \begin{pmatrix} 3/2 \\ 3/2 \end{pmatrix} = 3/2$

4. $pAq^t = p \begin{pmatrix} 1 \\ 2 \end{pmatrix} = 2$

5. $pAq^t = p \begin{pmatrix} 3 \\ 0 \end{pmatrix} = 2$

6. $pAq^t = p \begin{pmatrix} 5/3 \\ 5 \\ 2 \end{pmatrix} = 26/9$

7. $pAq^t = p \begin{pmatrix} 4 \\ 3 \\ -2 \end{pmatrix} = 8/3$

8. $pAq^t = p \begin{pmatrix} 8/5 \\ 5 \\ 6/5 \end{pmatrix} = 31/10$

9. $pAq^t = p \begin{pmatrix} 23/10 \\ 33/10 \\ 21/5 \end{pmatrix} = 149/40 = 3.725$

10. $pAq^t = p \begin{pmatrix} 5/4 \\ 3/2 \\ 2 \end{pmatrix} = 31/20 = 1.55$

11. $p_0 = (1/2 \ 1/2)$; $q_0 = (1/2 \ 1/2)$; $v = 1/2$

12. $p_0 = (3/5 \ 2/5)$; $q_0 = (4/5 \ 1/5)$; $v = 7/5$

13. $p_0 = (4/5 \ 1/4)$; $q_0 = (2/5 \ 3/5)$; $v = 2/5$

14. $p_0 = (1/2 \ 1/2)$; $q_0 = (1/2 \ 1/2)$; $v = 0$; fair

15. $p_0 = (1 \ 0)$; $q_0 = (1 \ 0)$; $v = 0$; fair

16. $p_0 = (1/2 \ 1/2)$; $q_0 = (1/2 \ 1/2)$; $v = 0$; fair

17. $p_0 = (1 \ 0)$; $q_0 = (1/2 \ 1/2)$ or $(0 \ 1)$; $v = -1$

18. $p_0 = (1 \ 0)$ or $(0 \ 1)$ or $(1/2 \ 1/2)$; $q_0 = (1 \ 0)$; $v = 1/2$

19. $p_0 = (1 \ 0)$; $q_0 = (1 \ 0)$; $v = 3$

20. $p_0 = (1/2 \ 1/2)$; $q_0 = (3/8 \ 5/8)$; $v = 0$; fair

21. $A' = \begin{pmatrix} 4 & 2 \\ 3 & 6 \end{pmatrix}$; $p_0 = (3/5 \ 2/5)$; $q_0 = (0 \ 4/5 \ 1/5)$; $v = 18/5$

22. $A' = \begin{pmatrix} 3 & 2 \\ 2 & 6 \end{pmatrix}$; $p_0 = (4/5 \ 1/5 \ 0)$; $q_0 = (0 \ 4/5 \ 1/5)$; $v = 14/5$

23. $A' = \begin{pmatrix} 5 & 8 & 4 \\ 4 & 6 & 9 \\ 5 & 7 & 2 \end{pmatrix}$; $A'' = \begin{pmatrix} 5 & 4 \\ 4 & 9 \end{pmatrix}$; $p_0 = (5/6 \ 0 \ 1/6 \ 0)$; $q_0 = (5/6 \ 0 \ 1/6)$; $v = 29/6 \approx 4.833$

24. $E(p, q) = (p_1 \ 1 - p_1) \begin{pmatrix} 10 & 39 \\ 5 & 40 \end{pmatrix} \begin{pmatrix} q_1 \\ 1 - q_1 \end{pmatrix} = (p_1 \ 1 - p_1) \begin{pmatrix} 39 - 29q_1 \\ 40 - 35q_1 \end{pmatrix}$. If the patient has the operation, then $p = (1 \ 0)$, and $E(p, q) = 39 - 29q_1$. If the patient does not have the operation, then $p = (0 \ 1)$, and $E(p, q) = 40 - 35q_1$. The patient should have the operation if $39 - 29q_1 > 40 - 35q_1$, so that $q_1 > 1/6$.

25. Let q_1 be the probability that the patient has the disease. So $q^t = \begin{pmatrix} q_1 \\ 1 - q_1 \end{pmatrix}$. Let $p = (p_1 \ 1 - p_1)$.

Then $E(p, q) = (p_1 \ 1 - p_1) \begin{pmatrix} a_{11} & a_{12} \\ a_{21} & a_{22} \end{pmatrix} \begin{pmatrix} q_1 \\ 1 - q_1 \end{pmatrix} = (a_{11} + a_{22} - a_{12} - a_{21})p_1q_1 + (a_{12} - a_{22})p_1 + (a_{21} - a_{22})q_1 + a_{22}$. If the patient has the operation, then $p = (1 \ 0)$ and $E(p, q) = (a_{11} - a_{12})q_1 + a_{12}$. If the patient does not have the operation, then $p = (0 \ 1)$ and $E(p, q) = (a_{21} - a_{22})q_1 + a_{22}$. So the operation should be recommended if $(a_{11} - a_{12})q_1 + a_{12} > (a_{21} - a_{22})q_1 + a_{22}$, i.e., when $q_1 >$

$$\frac{a_{22} - a_{12}}{a_{11} + a_{22} - a_{12} - a_{21}}$$

26. unfair since $v = 1/12 \neq 0$; $p_0 = (7/12 \ 5/12)$; $q_0 = (7/12 \ 5/12)$

27. unfair since $v = 1/36$; $p_0 = (19/36 \ 17/36)$; $q_0 = (19/36 \ 17/36)$

$$28. \begin{pmatrix} -1 & -3 & -11 \\ 4 & 0 & -5 \\ 9 & 3 & -1 \end{pmatrix} \begin{pmatrix} 1/2 \\ 0 \\ 1/2 \end{pmatrix} = \begin{pmatrix} -6 \\ -1/2 \\ 4 \end{pmatrix}; A \text{ should decrease prices}$$

$$29. \begin{pmatrix} 8 & 8 \\ 11 & 5 \end{pmatrix} \begin{pmatrix} 1/2 \\ 1/2 \end{pmatrix} = \begin{pmatrix} 8 \\ 8 \end{pmatrix}; \text{ any strategy is optimal}$$

$$30. \begin{pmatrix} 8 & 8 \\ 11 & 5 \end{pmatrix} \begin{pmatrix} 0.8 \\ 0.2 \end{pmatrix} = \begin{pmatrix} 8 \\ 9.8 \end{pmatrix}; \text{ the farmer should harvest late}$$

$$31. \begin{pmatrix} 8 & 8 \\ 11 & 5 \end{pmatrix} \begin{pmatrix} 0.1 \\ 0.9 \end{pmatrix} = \begin{pmatrix} 8 \\ 5.6 \end{pmatrix}; \text{ the farmer should harvest early}$$

32. $A = 1,500 \begin{pmatrix} 20 & 10 \\ 10 & 30 \end{pmatrix}$. The farmer "plays" the rows, and nature "plays" the columns. Rows I and II correspond to crops I and II, while columns I and II correspond to cold and hot, respectively. $\mathbf{p}_0 = (2/3 \ 1/3)$, $\mathbf{q}_0 = (2/3 \ 1/3)$, and $v = 25,000$. The farmer should plant 1,000 acres of crop I and 500 acres of crop II.

$$33. 1,500 \begin{pmatrix} 20 & 10 \\ 10 & 30 \end{pmatrix} \begin{pmatrix} 1/2 \\ 1/2 \end{pmatrix} = 1,500 \begin{pmatrix} 15 \\ 20 \end{pmatrix}, \text{ so the farmer should plant 1,500 acres of crop II only.}$$

34. $A = \begin{pmatrix} 2 & 0 \\ 0 & 1 \\ 0 & 1 \end{pmatrix}$. Rows I, II, and III correspond to the choices for the monkey, and columns I and II correspond to the choices for the experimenter. $\mathbf{p}_0 = (1/3 \ 2/3 \ 0)$ or $(1/3 \ 0 \ 2/3)$, $\mathbf{q}_0 = (1/3 \ 2/3)$, and $v = 2/3$.

35. By von Neumann's Theorem, $E(\mathbf{p}, \mathbf{q}_0) \leq v$ for any strategy \mathbf{p} . \mathbf{q}_0 must have some nonzero element q_i . Assume $\mathbf{p} = (1 \ 0 \ 0 \ \dots \ 0)$. Then $E(\mathbf{p}, \mathbf{q}_0) = \mathbf{p}A\mathbf{q}_0 = (1 \ 0 \ 0 \ \dots \ 0)$

$$\begin{pmatrix} a_{11} & a_{12} & \dots & a_{1n} \\ a_{21} & a_{22} & \dots & a_{2n} \\ \vdots & \vdots & \ddots & \vdots \\ a_{m1} & a_{m2} & \dots & a_{mn} \end{pmatrix} \begin{pmatrix} q_1 \\ q_2 \\ \vdots \\ q_n \end{pmatrix} = (a_{11} \ \dots \ a_{1i} \ \dots \ a_{1n}) \begin{pmatrix} q_1 \\ \vdots \\ q_i \\ \vdots \\ q_n \end{pmatrix} = a_{11}q_1 + \dots + a_{1i}q_i + \dots + a_{1n}q_n > 0$$

since $a_{1i}q_i \geq 0$. Thus $v > 0$.

36. We will first show that the optimal strategies for R and C are the same for B as for A . Let K be the $m \times n$ matrix where each component of K is k . Let \mathbf{q}_0 be an optimal strategy for C with respect to A , and let v be the value of A . Then for any strategy \mathbf{p} , we have $v \geq E(\mathbf{p}, \mathbf{q}_0) = \mathbf{p}A\mathbf{q}_0^t = \mathbf{p}(B-K)\mathbf{q}_0^t$. But $\mathbf{p}K\mathbf{q}_0^t = k$, so that $\mathbf{p}B\mathbf{q}_0^t \leq v + k$. Similarly, if \mathbf{p}_0 is an optimal strategy for R with respect to A , then for arbitrary \mathbf{q} , $\mathbf{p}_0B\mathbf{q}^t \geq v + k$. Hence the optimal strategies for the two matrices are the same, and the value of B is the value of A plus the constant k .

$$37. \mathbf{p}_0 = (1 \ 0); \mathbf{q}_0 = (0 \ 1); v_A = 2; v_B = 4$$

$$38. \mathbf{p}_0 = (0 \ 1 \ 0); \mathbf{q}_0 = (1/3 \ 2/3 \ 0); v_A = 2; v_B = 1$$

$$39. (a) \mathbf{p}_0 = \mathbf{q}_0 = (1 - t \ t) \text{ for all } t, 0 \leq t \leq 1$$

(b) $\mathbf{p}_0 = (1 \ 0)$ for all t , $0 \leq t \leq 1$. If $0 \leq t < 1/2$, then $\mathbf{q}_0 = (0 \ 1)$. If $1/2 \leq t \leq 1$, then $\mathbf{q}_0 = (1 \ 0)$.

(c) If $0 \leq t < 1/2$, then $\mathbf{p}_0 = (1 \ 0)$ and $\mathbf{q}_0 = (0 \ 1)$. If $1/2 < t \leq 1$, then $\mathbf{p}_0 = (1 \ 0)$ and $\mathbf{q}_0 = (0 \ 1)$.
If $t = 1/2$, then \mathbf{p}_0 can be any strategy and $\mathbf{q}_0 = (0 \ 1)$.

$$40. (a) \text{ For all } t, 0 \leq t \leq 1, \mathbf{p}_0A\mathbf{q}_0^t = t(1 - t)$$

(b) For $0 \leq t < 1/2$, $\mathbf{p}_0A\mathbf{q}_0^t = 2t$. For $1/2 \leq t \leq 1$, $\mathbf{p}_0A\mathbf{q}_0^t = 1$

(c) For $0 \leq t \leq 1/2$, $\mathbf{p}_0A\mathbf{q}_0^t = 1/4$. For $1/2 < t \leq 1$, $\mathbf{p}_0A\mathbf{q}_0^t = t^2$

41. (a) If $t < 1/2$ then the row minimums are g and the column maximums are $1 - t$ so the game is not strictly determined. If $t = 1/2$ then the matrix is $\begin{pmatrix} 1/2 & 1/2 \\ 1/2 & 1/2 \end{pmatrix}$, which is not strictly determined. If $t > 1/2$ then the row minimums are $1 - t$ and the column maximums are t , so the game is not strictly determined.

(b) $v = (2t - 1)/(4t - 2) = 1/2$

42. (a) Let $\mathbf{p}_0 A = (b_1 \ b_2 \ \cdots \ b_2)$. Then $\mathbf{p}_0 A \mathbf{q}_0^t = \sum_{i=1}^n b_i q_i \geq \sum v q_i = v$.

- (b) Let \mathbf{q} be the column vector with 1 in the k^{th} position and 0 everywhere else. Then $\mathbf{p}_0 A \mathbf{q} = k^{\text{th}}$ component of $\mathbf{p}_0 A \geq v$. Hence every component of $\mathbf{p}_0 A$ is greater than or equal to v .

43. Suppose every component of $A \mathbf{q}_0^t$ is less than or equal to v . Let $A \mathbf{q}_0^t = \begin{pmatrix} b_1 \\ b_2 \\ \vdots \\ b_m \end{pmatrix}$. Then $E(\mathbf{p}, \mathbf{q}_0) =$

$$\mathbf{p} A \mathbf{q}_0^t = \sum_{i=1}^m p_i b_i \leq \sum_{i=1}^m p_i v = v. \text{ Conversely, suppose } E(\mathbf{p}, \mathbf{q}_0) \leq v \text{ for every } \mathbf{p}. \text{ Let } \mathbf{p} \text{ be the strategy}$$

with 1 in the k^{th} position and 0 everywhere else. Then the k^{th} component of $A \mathbf{q}_0^t = \mathbf{p} A \mathbf{q}_0^t \leq v$. Hence the components of $A \mathbf{q}_0^t$ are less than or equal to v .

44. (a) The first component of $\mathbf{p}_0 A$ is $[a_{11}(a_{22} - a_{21}) + a_{21}(a_{11} - a_{12})]/(a_{11} + a_{22} - a_{12} - a_{21})$, which upon simplifying, is equal to v . The first component of $A \mathbf{q}_0^t$ is $[a_{11}(a_{22} - a_{12}) + a_{12}(a_{11} - a_{21})]/(a_{11} + a_{22} - a_{12} - a_{21})$, and upon simplifying, is equal to v . Similarly, the second component of $A \mathbf{q}_0^t$ and the second component of $\mathbf{p}_0 A$ are equal to v .

- (b) Since we have part (a), then problems 42 and 43 imply that \mathbf{p}_0 and \mathbf{q}_0 are optimal strategies, and that v is the value of the game.

Application 2.3

1. (a) Let $B = \begin{pmatrix} 5 & 7 \\ 6 & 1 \end{pmatrix}$

x_1	x_2	s_1	s_2
5	7	1	0
6	1	0	1
1	1	0	0

 $\xrightarrow{s_1, s_2}$

x_1	x_2	s_1	s_2
0	37/6	1	-5/6
1	1/6	0	1/6
0	5/6	0	-1/6

x_1	x_2	s_1	s_2
0	1	6/37	-5/37
1	0	-1/37	7/37
0	0	-5/37	-2/37

 \rightarrow

x_2
1/37
6/37
$f - 7/37$

$$p_0 = 37/7 (5/37 \ 2/37) = (5/7 \ 2/7)$$

$$q_0 = 37/7 (6/37 \ 1/37) = (6/7 \ 1/7)$$

$$v = 37/7 - 3 = 16/7$$

(b) Let $B = \begin{pmatrix} 3 & 2 \\ 1 & 3 \end{pmatrix}$

x_1	x_2	s_1	s_2
3	2	1	0
1	3	0	1
1	1	0	0

 $\xrightarrow{s_1, s_2}$

x_1	x_2	s_1	s_2
1	2/3	1/3	0
0	7/3	-1/3	1
0	1/3	-1/3	0

x_1	x_2	s_1	s_2
1	0	3/7	-2/7
0	1	-1/7	3/7
0	0	-6/21	-1/7

 \rightarrow

x_1
1/7
2/7
$f - 3/7$

$$p_0 = 7/3 (6/21 \ 1/7) = (2/3 \ 1/3)$$

$$q_0 = 7/3 (1/7 \ 2/7) = (1/3 \ 2/3)$$

$$v = 7/3 - 2 = 1/3$$

2. (a) Let $B = \begin{pmatrix} 3 & 2 & 3 \\ 1 & 4 & 2 \\ 4 & 1 & 1 \end{pmatrix}$.

x_1	x_2	x_3	s_1	s_2	s_3
3	2	3	1	0	0
1	4	2	0	1	0
4	1	1	0	0	1
1	1	1	0	0	0

 $\xrightarrow{s_1, s_2, s_3}$

x_1	x_2	x_3	s_1	s_2	s_3
0	5/4	9/4	1	0	-3/4
0	15/4	7/4	0	1	-1/4
1	1/4	1/4	0	0	1/4
0	3/4	3/4	0	0	-1/4

x_1	x_2	x_3	s_1	s_2	s_3
0	0	5/3	1	-1/3	-2/3
0	1	7/15	0	4/15	-1/15
1	0	2/15	0	-1/15	4/15
0	0	2/5	0	-1/5	-1/5

 \rightarrow

s_1
0
1/5
1/5
$f - 2/5$

x_1	x_2	x_3	s_1	s_2	s_3
0	0	1	3/5	-1/5	-2/5
0	1	0	-7/25	9/25	3/25
1	0	0	-2/25	-1/25	8/25
0	0	0	-6/25	-3/25	-1/25

 \rightarrow

x_3
0
1/5
1/5
$f - 2/5$

$$p_0 = 5/2 (6/25 \ 3/25 \ 1/25) = (3/5 \ 3/10 \ 1/10)$$

$$q_0 = 5/2 (1/5 \ 1/5 \ 0) = (1/2 \ 1/2 \ 0)$$

$$v = 5/2 - 2 = 1/2$$

(b) Let $B = \begin{pmatrix} 5 & 6 & 5 \\ 4 & 1 & 2 \\ 7 & 2 & 3 \end{pmatrix}$.

x_1	x_2	x_3	s_1	s_2	s_3	
5	6	5	1	0	0	1
4	1	2	0	1	0	1
7	2	3	0	0	1	1
1	1	1	0	0	0	f

 \rightarrow

x_1	x_2	x_3	s_1	s_2	s_3	
0	32/7	20/7	1	0	-5/7	2/7
0	-1/7	2/7	0	1	-4/7	3/7
1	2/7	3/7	0	0	1/7	1/7
0	5/7	4/7	0	0	-1/7	$f - 1/7$

 \rightarrow

x_1	x_2	x_3	s_1	s_2	s_3	
0	1	5/8	7/32	0	-5/32	1/16
0	0	3/8	1/32	1	-19/32	7/16
1	0	1/4	-1/16	0	3/16	1/8
0	0	1/8	-5/32	0	-1/32	$f - 3/16$

 \rightarrow

x_1	x_2	x_3	s_1	s_2	s_3	
0	8/5	1	7/20	0	-1/4	1/10
0	-3/5	0	-1/10	1	-1/2	2/5
1	-1/4	0	-3/20	0	1/4	1/10
0	-1/5	0	-1/5	0	0	$f - 1/5$

$$p_0 = 5(1/5 \ 0 \ 0) = (1 \ 0 \ 0)$$

$$q_0 = 5(1/10 \ 0 \ 1/10) = (1/2 \ 0 \ 1/2)$$

$$v = 5 - 3 = 2$$

3. By using linear programming to find $f = 1/v$, the solution for f is positive, which implies v is also positive.

4. Ex. 2:

x_1	x_2	s_1	s_2	
2	1	1	0	1
-2	2	0	1	1
1	1	0	0	f

 \rightarrow

x_1	x_2	s_1	s_2	
1	1/2	1/2	0	1/2
0	3	1	1	2
0	1/2	-1/2	0	$f - 1/2$

 \rightarrow

x_1	x_2	s_1	s_2	
1	0	1/3	-1/6	1/6
0	1	1/3	1/3	2/3
0	0	-2/3	-1/6	$f - 5/6$

$$p_0 = 6/5(2/3 \ 1/6) = (4/5 \ 1/5)$$

$$q_0 = 6/5(1/6 \ 2/3) = (1/5 \ 4/5)$$

Ex. 3:

x_1	x_2	x_3	s_1	s_2	s_3	
4	-2	-5	1	0	0	1
-2	8	-3	0	1	0	1
-5	-3	14	0	0	1	1
1	1	1	0	0	0	f

 \rightarrow

x_1	x_2	x_3	s_1	s_2	s_3	
1	-1/2	-5/4	1/4	0	0	1/4
0	7	-11/2	1/2	1	0	3/2
0	-11/2	31/4	5/4	0	1	9/4
0	3/2	9/4	-1/4	0	0	$f - 1/4$

	x_1	x_2	x_3	s_1	s_2	s_3		
→	1	0	-23/14	2/7	-1/3	0	5/14	x_1
	0	1	-11/14	1/14	1/7	0	3/14	x_2
	0	0	24/7	23/14	11/14	1	24/7	s_3
	0	0	24/7	-5/14	-3/14	0	$f - 4/7$	

	x_1	x_2	x_3	s_1	s_2	s_3		
→	1	0	0	*	*	*	2	x_3
	0	1	0	*	*	*	1	x_2
	1	0	0	23/48	11/48	7/24	1	x_1
	0	0	0	-2	-1	-1	$f - 4$	

$p_0 = 1/4(2 \ 1 \ 1) = (1/2 \ 1/4 \ 1/4)$

$q_0 = 1/4(2 \ 1 \ 1) = (1/2 \ 1/4 \ 1/4)$

5. Let $B = \begin{pmatrix} 4 & 6 & 2 & 2 \\ 1 & 9 & 6 & 1 \\ 4 & 1 & 19 & 1 \\ 7 & 4 & 1 & 2 \end{pmatrix}$

	x_1	x_2	x_3	x_4	s_1	s_2	s_3	s_4		
→	4	6	2	2	1	0	0	0	1	s_1
	1	9	6	1	0	1	0	0	1	s_2
	4	1	19	1	0	0	1	0	1	s_3
	7	4	1	2	0	0	0	1	1	s_4
	1	1	1	1	0	0	0	0	f	

	x_1	x_2	x_3	x_4	s_1	s_2	s_3	s_4		
→	2	3	1	1	1/2	0	0	0	1/2	x_4
	-1	6	5	0	-1/2	1	0	0	1/2	s_2
	2	-2	18	0	-1/2	0	1	0	1/2	s_3
	3	-2	-1	0	-1	0	0	1	0	s_4
	-1	-2	0	0	-1/2	0	0	0	$f - 1/2$	

$p_0 = 2(1/2 \ 0 \ 0 \ 0) = (1 \ 0 \ 0 \ 0)$

$q_0 = 2(0 \ 0 \ 0 \ 1/2) = (0 \ 0 \ 0 \ 1)$

$v = 2 - 2 = 0$

6.

	x_1	x_2	s_1	s_2		x_1	x_2	s_1	s_2		
→	10	9	1	0	1	1	9/10	1/10	0	1/10	x_1
	0	100	0	1	1	0	100	0	1	1	s_2
	1	1	0	0	f	0	1/10	-1/10	0	$f - 1/10$	

	x_1	x_2	s_1	s_2		
→	0	1	1/10	-9/1000	91/1000	x_1
	1	0	0	1/100	1/100	x_2
	0	0	-1/10	-1/1000	$f - 101/1000$	

$p_0 = 1000/101(1/10 \ 1/1000) = (100/101 \ 1/101)$

$q_0 = 1000/101(91/1000 \ 1/100) = (91/101 \ 10/101)$

If the game is to be played only once, one way R could determine his move is to place one hundred 1's and one 2 in a box and select one value at random. Any time R wishes to guarantee a return of at least nine units, he should choose the first row. R will choose the second row on an average of one out of every 101 times.

Application 2.4

1. yes 2. no 3. yes 4. no 5. no
 6. yes 7. yes 8. no 9. yes 10. yes
11. $\mathbf{p}_1 = (5/8 \ 3/8)$; $\mathbf{p}_2 = (19/32 \ 13/32)$; $\mathbf{p}_3 = (77/128 \ 51/128)$
 12. $\mathbf{p}_1 = (1/2 \ 1/2)$; $\mathbf{p}_2 = (5/8 \ 3/8)$; $\mathbf{p}_3 = (19/32 \ 13/32)$
 13. $\mathbf{p}_1 = (2/3 \ 1/3)$; $\mathbf{p}_2 = (11/36 \ 25/36)$; $\mathbf{p}_3 = (433/864 \ 431/864)$
 14. $\mathbf{p}_1 = (9/20 \ 11/20)$; $\mathbf{p}_2 = (203/480 \ 277/480)$; $\mathbf{p}_3 = (5,041/11,520 \ 6,479/11,520)$
 15. $\mathbf{p}_1 = (11/48 \ 13/24 \ 11/48)$; $\mathbf{p}_2 = (25/72 \ 11/36 \ 25/72)$; $\mathbf{p}_3 = (29/108 \ 25/54 \ 29/108)$
 16. $\mathbf{p}_1 = (17/30 \ 1/5 \ 7/30)$; $\mathbf{p}_2 = (161/360 \ 41/120 \ 19/90)$; $\mathbf{p}_3 = (587/1080 \ 199/720 \ 389/2160)$
 17. $\mathbf{p}_1 = (0.2214 \ 0.4 \ 0.3786)$; $\mathbf{p}_2 = (0.3034 \ 0.4418 \ 0.2548)$; $\mathbf{p}_3 = (0.3098 \ 0.4994 \ 0.1908)$
 18. $\mathbf{p}_1 = \mathbf{p}_3 = (0 \ 0 \ 1)$; $\mathbf{p}_2 = \mathbf{p}_0 = (1 \ 0 \ 0)$
 19. $\mathbf{p}_1 = \mathbf{p}_2 = \mathbf{p}_3 = (1/3 \ 1/3 \ 1/3)$
 20. $\mathbf{p}_1 = (0.2433 \ 0.4596 \ 0.2971)$; $\mathbf{p}_2 = (0.2546 \ 0.4482 \ 0.2973)$; $\mathbf{p}_3 = (0.2538 \ 0.4471 \ 0.2991)$
 21. regular; $(2/5 \ 3/5)$ 22. regular; $(1/2 \ 1/2)$ 23. not regular
 24. regular; $(15/33 \ 18/33)$ 25. regular; $\left(\frac{b}{1-a+b} \ \frac{1-a}{1-a+b} \right)$
26. As $T^2 = \begin{pmatrix} 3/8 & 1/4 & 3/8 \\ 13/36 & 5/18 & 13/36 \\ 17/48 & 7/24 & 17/48 \end{pmatrix}$, then T is regular. The fixed probability vector is $(4/11 \ 3/11 \ 4/11)$.
27. not regular 28. regular; $(14/45 \ 19/45 \ 12/45)$ 29. regular; $(0.2843 \ 0.3768 \ 0.3390)$
30. regular since $T^2 = \begin{pmatrix} 0.1857 & 0.2638 & 0.1285 & 0.4220 \\ 0.2040 & 0.2667 & 0.1887 & 0.3406 \\ 0.1646 & 0.2058 & 0.2100 & 0.4195 \\ 0.1001 & 0.2719 & 0.2782 & 0.3500 \end{pmatrix}$; $(0.1538 \ 0.2550 \ 0.2175 \ 0.3737)$
31. (a) $(0 \ 0 \ 1)T = (0 \ 0 \ 1)$; (b) Yes, since a probability vector must have nonnegative components.
 32. (a) $(0 \ 0 \ 1)T = (0 \ 0 \ 1)$; (b) $(0 \ 1 \ 0)T = (0 \ 1 \ 0)$
 33. The system is the person, and the states are the person's health.
 The transition matrix is $\begin{pmatrix} 0.98 & 0.02 \\ 0.3 & 0.7 \end{pmatrix}$.
34. $\mathbf{p}_0 = (0 \ 1)$, $\mathbf{p}_1 = (0.3 \ 0.7)$, $\mathbf{p}_2 = (0.504 \ 0.496)$, and $\mathbf{p}_3 = (0.643 \ 0.357)$. So the probability she will recover is 0.3 in 1 day, 0.504 in 2 days, and 0.643 in 3 days.
 35. The unique fixed probability vector is $(0.9375 \ 0.0625)$. Hence 93.75% of the days she will be healthy.
36. (a) The states are compartments I, II, III, IV, and V. The transition matrix is
- $$\begin{pmatrix} 0 & 0 & 0 & 1/2 & 1/2 \\ 0 & 0 & 1/2 & 0 & 1/2 \\ 0 & 1/2 & 0 & 0 & 1/2 \\ 1/2 & 0 & 0 & 0 & 1/2 \\ 1/4 & 1/4 & 1/4 & 1/4 & 0 \end{pmatrix}.$$
- (b) By squaring the transition matrix, we see that the matrix is regular. The unique fixed probability vector is $(1/6 \ 1/6 \ 1/6 \ 1/6 \ 1/3)$. So the mouse will spend approximately 16.67% of the time in compartments I, II, III, and IV, and will spend 33.33% of the time in compartment V.

37. The transition matrix is $\begin{pmatrix} 3/4 & 1/4 \\ 1/4 & 3/4 \end{pmatrix}$. The fixed probability vector is $(1/2 \ 1/2)$. However the first question is answered, the approximate exam score will be 50% (50 correct and 50 incorrect).
38. (a) The states are the three choices of food the animal can make. The transition matrix is

$$\begin{pmatrix} 1/2 & 1/4 & 1/4 \\ 1/4 & 1/2 & 1/4 \\ 1/4 & 1/4 & 1/2 \end{pmatrix}.$$

- (b) The unique fixed probability vector is $(1/3 \ 1/3 \ 1/3)$.

39. The states are the possible grades. The transition matrix is $\begin{pmatrix} 0.6 & 0.1 & 0.1 & 0.1 & 0.1 \\ 0.1 & 0.6 & 0.1 & 0.1 & 0.1 \\ 0.1 & 0.1 & 0.6 & 0.1 & 0.1 \\ 0.1 & 0.1 & 0.1 & 0.6 & 0.1 \\ 0.1 & 0.1 & 0.1 & 0.1 & 0.6 \end{pmatrix}$.

40. (a) $0.6 \cdot 0.1 + 0.1 \cdot 0.1 + 0.1 \cdot 0.6 + 0.1 \cdot 0.1 + 0.1 \cdot 0.1 = 0.15$
 (b) $0.6^3 = 0.216$

41. The states are the three locations. The transition matrix is $\begin{pmatrix} 0.6 & 0.3 & 0.1 \\ 0.2 & 0.5 & 0.3 \\ 0.1 & 0.2 & 0.7 \end{pmatrix}$.

42. The unique fixed probability vector is approximately $(0.2647 \ 0.3235 \ 0.4118)$. Hence 26.47% of the cars will be in the northern area, 32.35% of the cars will be in the central area, and 41.18% of the cars will be in the southern area.

43. The states are the college campuses. The transition matrix is $\begin{pmatrix} 0 & 7/10 & 0 & 3/10 \\ 1/3 & 0 & 1/3 & 1/3 \\ 0 & 1 & 0 & 0 \\ 1/3 & 1/3 & 1/3 & 0 \end{pmatrix}$.

44. Upon squaring the matrix, we see that it is regular. The unique fixed probability vector is $(1/5 \ 81/200 \ 1/5 \ 39/200)$. So he will spend 20%, 40.5%, 20%, and 19.5% of his time in regions I, II, III, and IV, respectively.

45. $\$700 \cdot 0.2 + \$650 \cdot 0.405 + \$580 \cdot 0.2 + \$280 \cdot 0.195 = \$679.15$

46. The transition matrix for copy machine I is $\begin{pmatrix} 0.95 & 0.05 \\ 0.75 & 0.25 \end{pmatrix}$, which has $(15/16 \ 1/16)$ as its fixed probability vector. The transition matrix for copy machine II is $\begin{pmatrix} 0.9 & 0.1 \\ 0.8 & 0.2 \end{pmatrix}$, which has $(8/9 \ 1/9)$ as its fixed probability vector. Thus the company should choose copy machine I.

47. The transition matrix is $\begin{pmatrix} 0.7 & 0.2 & 0.1 \\ 0.35 & 0.6 & 0.05 \\ 0.4 & 0.3 & 0.3 \end{pmatrix}$. The fixed probability vector is approximately $(0.5464 \ 0.3505 \ 0.1031)$. So over the long run, 54.64% will vote Democrat, 35.05% will vote Republican, and 10.31% will vote Independent.

Application 2.5

1. One absorbing state.
2. No absorbing states.
3. Two absorbing states.
4. One absorbing state.
5. One absorbing state.
6. No absorbing states.
7. Two absorbing states.
8. One absorbing state.
9. Two absorbing states.
10. Two absorbing states.
11. $T' = \begin{pmatrix} 1/3 & 2/3 \end{pmatrix}$; $S = (2/3)$; $R = (1/3)$; $Q = (3/2)$; $A = (1)$
12. $T' = \begin{pmatrix} 3/4 & 1/4 \end{pmatrix}$; $S = (3/4)$; $R = (1/4)$; $Q = (4/3)$; $A = (1)$
13. $T' = \begin{pmatrix} 1/3 & 1/3 & 1/3 \\ 1/2 & 0 & 1/2 \end{pmatrix}$; $S = \begin{pmatrix} 1/3 \\ 1/2 \end{pmatrix}$; $R = \begin{pmatrix} 1/3 & 1/3 \\ 1/2 & 0 \end{pmatrix}$; $Q = \begin{pmatrix} 2 & 2/3 \\ 1 & 4/3 \end{pmatrix}$; $A = \begin{pmatrix} 1 \\ 1 \end{pmatrix}$
14. $T' = \begin{pmatrix} 0.2 & 0.7 & 0.1 \\ 0.6 & 0.1 & 0.3 \end{pmatrix}$; $S = \begin{pmatrix} 0.1 \\ 0.3 \end{pmatrix}$; $R = \begin{pmatrix} 0.2 & 0.7 \\ 0.6 & 0.1 \end{pmatrix}$; $Q = \begin{pmatrix} 3 & 7/3 \\ 2 & 8/3 \end{pmatrix}$; $A = \begin{pmatrix} 1 \\ 1 \end{pmatrix}$
15. $T' = (0.4 \ 0.4 \ 0.2)$; $S = (0.4 \ 0.2)$; $R = (0.4)$; $Q = (5/3)$; $A = (2/3 \ 1/3)$
16. $T' = \begin{pmatrix} 1/2 & 1/3 & 1/6 & 0 \\ 1/4 & 1/4 & 1/4 & 1/4 \end{pmatrix}$; $S = \begin{pmatrix} 1/6 & 0 \\ 1/4 & 1/4 \end{pmatrix}$; $R = \begin{pmatrix} 1/2 & 1/3 \\ 1/4 & 1/4 \end{pmatrix}$; $Q = \begin{pmatrix} 18/7 & 8/7 \\ 6/7 & 12/7 \end{pmatrix}$;
 $A = \begin{pmatrix} 5/7 & 2/7 \\ 4/7 & 3/7 \end{pmatrix}$
17. $T' = \begin{pmatrix} 1/3 & 1/3 & 1/6 & 1/6 \\ 1/2 & 0 & 0 & 1/2 \end{pmatrix}$; $S = \begin{pmatrix} 1/3 & 1/6 \\ 1/2 & 1/2 \end{pmatrix}$; $R = \begin{pmatrix} 1/3 & 1/6 \\ 0 & 0 \end{pmatrix}$; $Q = \begin{pmatrix} 3/2 & 1/4 \\ 0 & 1 \end{pmatrix}$;
 $A = \begin{pmatrix} 5/8 & 3/8 \\ 1/2 & 1/2 \end{pmatrix}$
18. $T' = \begin{pmatrix} 0.21 & 0.46 & 0.13 & 0.20 \\ 0.31 & 0.25 & 0.21 & 0.23 \end{pmatrix}$; $S = \begin{pmatrix} 0.46 & 0.20 \\ 0.25 & 0.23 \end{pmatrix}$; $R = \begin{pmatrix} 0.21 & 0.13 \\ 0.31 & 0.21 \end{pmatrix}$; $Q = \frac{1}{0.5838} \begin{pmatrix} 0.79 & 0.13 \\ 0.31 & 0.79 \end{pmatrix}$;
 $A = \frac{1}{0.5838} \begin{pmatrix} 0.3959 & 0.1879 \\ 0.3401 & 0.2077 \end{pmatrix}$
19. $T' = \begin{pmatrix} 1/8 & 1/4 & 1/8 & 1/8 & 3/8 \\ 1/7 & 2/7 & 1/7 & 2/7 & 1/7 \\ 1/4 & 1/2 & 0 & 1/8 & 1/8 \end{pmatrix}$; $S = \begin{pmatrix} 1/8 & 3/8 \\ 2/7 & 1/7 \\ 1/8 & 1/8 \end{pmatrix}$; $R = \begin{pmatrix} 1/8 & 1/4 & 1/8 \\ 1/7 & 2/7 & 1/7 \\ 1/4 & 1/2 & 0 \end{pmatrix}$;
 $Q = \frac{1}{109} \begin{pmatrix} 144 & 70 & 28 \\ 40 & 189 & 32 \\ 56 & 112 & 132 \end{pmatrix}$; $A = \frac{1}{218} \begin{pmatrix} 83 & 135 \\ 126 & 92 \\ 111 & 107 \end{pmatrix}$
20. $T' = \begin{pmatrix} 0.17 & 0.23 & 0.15 & 0.32 & 0.13 \\ 0.15 & 0.21 & 0 & 0.38 & 0.26 \end{pmatrix}$; $S = \begin{pmatrix} 0.23 & 0.32 & 0.13 \\ 0.21 & 0.38 & 0.26 \end{pmatrix}$; $R = \begin{pmatrix} 0.17 & 0.15 \\ 0.15 & 0 \end{pmatrix}$; $Q = \frac{1}{0.8075} \begin{pmatrix} 1 & 0.15 \\ 0.15 & 0.83 \end{pmatrix}$;
 $A = \frac{1}{0.8075} \begin{pmatrix} 0.2615 & 0.377 & 0.169 \\ 0.2088 & 0.3634 & 0.2353 \end{pmatrix}$
21. Let E_i , $i = 0, 1, 2, 3, 4$, be the state such that the animal has received i units of food. The state moves from E_i to E_{i+1} , $i = 0, 1, 2, 3$, with probability of $4/5$ and stays in E_i with probability of $1/5$. E_4 is an absorbing state. $T = \begin{pmatrix} 1/5 & 4/5 & 0 & 0 & 0 \\ 0 & 1/5 & 4/5 & 0 & 0 \\ 0 & 0 & 1/5 & 4/5 & 0 \\ 0 & 0 & 0 & 1/5 & 4/5 \\ 0 & 0 & 0 & 0 & 1 \end{pmatrix}$

$$22. T = \begin{pmatrix} 1/5 & 4/5 & 0 & 0 & 0 \\ 0 & 1/5 & 4/5 & 0 & 0 \\ 0 & 0 & 1/5 & 4/5 & 0 \\ 0 & 0 & 0 & 1/5 & 4/5 \end{pmatrix}; R = \begin{pmatrix} 1/5 & 4/5 & 0 & 0 \\ 0 & 1/5 & 4/5 & 0 \\ 0 & 0 & 1/5 & 4/5 \\ 0 & 0 & 0 & 1/5 \end{pmatrix}; Q = \begin{pmatrix} 5 & 20 & 80 & 320 \\ 0 & 5 & 20 & 80 \\ 0 & 0 & 5 & 20 \\ 0 & 0 & 0 & 5 \end{pmatrix}; \text{Expected number} \\ = 320.$$

23. (a). Let E_i , $i = 0, 1, \dots, 8$, be the state such that G_1 has i dollars. State E_i , $i = 1, 2, \dots, 7$, moves to state E_{i+1} with probability of $3/7$ and to state E_{i-1} with probability of $4/7$. E_0 and E_8 are absorbing states. The game begins at state E_7 .

$$(b) \mathbf{p}_0 = (0 \ 0 \ 0 \ 0 \ 0 \ 0 \ 0 \ 1 \ 0); G = \begin{pmatrix} 1 & 0 & 0 & 0 & 0 & 0 & 0 & 0 & 0 \\ 4/7 & 0 & 3/7 & 0 & 0 & 0 & 0 & 0 & 0 \\ 0 & 4/7 & 0 & 3/7 & 0 & 0 & 0 & 0 & 0 \\ 0 & 0 & 4/7 & 0 & 3/7 & 0 & 0 & 0 & 0 \\ 0 & 0 & 0 & 4/7 & 0 & 3/7 & 0 & 0 & 0 \\ 0 & 0 & 0 & 0 & 4/7 & 0 & 3/7 & 0 & 0 \\ 0 & 0 & 0 & 0 & 0 & 4/7 & 0 & 3/7 & 0 \\ 0 & 0 & 0 & 0 & 0 & 0 & 4/7 & 0 & 3/7 \\ 0 & 0 & 0 & 0 & 0 & 0 & 0 & 0 & 1 \end{pmatrix}$$

$$\mathbf{p}_1 = \mathbf{p}_0 T = (0 \ 0 \ 0 \ 0 \ 0 \ 0 \ 4/7 \ 0 \ 3/7)$$

$$\mathbf{p}_2 = \mathbf{p}_1 T = (0 \ 0 \ 0 \ 0 \ 0 \ 16/49 \ 0 \ 12/49 \ 3/7)$$

$$(c) A = \begin{pmatrix} 0.963 & 0.037 \\ 0.913 & 0.087 \\ 0.848 & 0.152 \\ 0.760 & 0.240 \\ 0.642 & 0.358 \\ 0.486 & 0.514 \\ 0.279 & 0.721 \end{pmatrix}; \text{Probability that } G_1 \text{ wins} = 0.721.$$

24. (a) Let E_i , $i = 0, 1, 2, 3, 4$, be the states where E_0 represents $G_1 = 0$, $G_2 = 8$, E_1 represents $G_1 = 4$, $G_2 = 4$, E_2 represents $G_1 = 6$, $G_2 = 2$, E_3 represents $G_1 = 7$, $G_2 = 1$ and E_4 represents $G_1 = 8$, $G_2 = 0$. State E_i , $i = 1, 2, 3$, moves to state E_{i+1} with probability of $3/7$ and to state E_{i-1} with probability of $4/7$. E_0 and E_4 are absorbing states. The game begins at state E_3 .

$$(b) Q = \frac{1}{25} \begin{pmatrix} 37 & 21 & 9 \\ 28 & 49 & 21 \\ 16 & 28 & 37 \end{pmatrix}; \text{Expected number of plays} = (16 + 28 + 37)/25 = 3.24$$

$$(c) A = \begin{pmatrix} 148/175 & 27/175 \\ 112/175 & 63/175 \\ 64/175 & 111/175 \end{pmatrix}; \text{Probability } G_1 \text{ wins} = 111/175 \approx 0.634$$

25. Let E_i , $i = 1, 2, 3, 4$, be the state such that panel i is chosen. The probability of moving from E_1 to any E_i is $1/4$. The probability of moving from E_2 to any E_i is $1/4$. E_3 and E_4 are absorbing states.

$$T = \begin{pmatrix} 1/4 & 1/4 & 1/4 & 1/4 \\ 1/4 & 1/4 & 1/4 & 1/4 \\ 0 & 0 & 1 & 0 \\ 0 & 0 & 0 & 1 \end{pmatrix}; Q = \begin{pmatrix} 3/2 & 1/2 \\ 1/2 & 3/2 \end{pmatrix}. \text{Expected number} = 1/2 + 3/2 = 2.$$

26. (a) Let E_1 be the not functioning state, E_2 be the fair state, E_3 be the good state and E_4 be the excellent state. E_1 and E_4 are absorbing states. $T =$

$$\begin{pmatrix} 1 & 0 & 0 & 0 \\ 0.05 & 0.25 & 0.35 & 0.35 \\ 0 & 0.15 & 0.2 & 0.65 \\ 0 & 0 & 0 & 1 \end{pmatrix}.$$

$$(b) Q = \begin{pmatrix} 1.4612 & 0.6393 \\ 0.2740 & 1.3699 \end{pmatrix}; \text{Retesting of fair units} = 1.4612 + 0.6393 = 2.1005.$$

$$(c) \text{Retesting of good units} = 0.2740 + 1.3699 = 1.6439$$

(d) $A = \begin{pmatrix} 0.0731 & 0.9269 \\ 0.0137 & 0.9863 \end{pmatrix}$; Probability of fair deck being thrown out is 0.0731.

(e) Probability of fair deck being released to sales is 0.9269.

(f) $(30000)(0.9863) = 29589$.

27. (a) Let $E_i, i = 1, 2, 3$, be the state that represents i months are delinquent. Let E_0 be the state that represents having paid up during the past three months and let E_4 be the state that represents card

revocation. E_0 and E_4 are absorbing states. $T = \begin{pmatrix} 1 & 0 & 0 & 0 & 0 \\ 0.65 & 0 & 0.35 & 0 & 0 \\ 0.6 & 0 & 0 & 0.4 & 0 \\ 0.3 & 0 & 0 & 0 & 0.7 \\ 0 & 0 & 0 & 0 & 1 \end{pmatrix}$.

(b) $A = \begin{pmatrix} 0.902 & 0.098 \\ 0.72 & 0.28 \\ 0.3 & 0.7 \end{pmatrix}$; Number of revoked cards = $(2356)(0.098) = 230.888$

28. $T = \begin{pmatrix} 0 & 0 & 0 & 1/2 & 1/2 \\ 1 & 0 & 0 & 0 & 0 \\ 0 & 1/2 & 0 & 0 & 1/2 \\ 0 & 0 & 0 & 1 & 0 \\ 1/4 & 1/4 & 1/4 & 1/4 & 0 \end{pmatrix}$; $Q = \frac{1}{11} \begin{pmatrix} 14 & 2 & 8 \\ 10 & 3 & 12 \\ 6 & 4 & 16 \end{pmatrix}$; $A = \frac{1}{11} \begin{pmatrix} 2 & 9 \\ 3 & 8 \\ 4 & 7 \end{pmatrix}$

(a) $14/11 + 2/11 + 8/11 = 24/11 \approx 2.18$

(b) $7/11 \times 100\% \approx 63.6\%$

29. $T = \begin{pmatrix} 0.30 & 0.45 & 0 & 0.25 \\ 0 & 0.10 & 0.75 & 0.15 \\ 0 & 0 & 1 & 0 \\ 0 & 0 & 0 & 1 \end{pmatrix}$; $A = \begin{pmatrix} 0.5357 & 0.4643 \\ 0.8333 & 0.1667 \end{pmatrix}$

$(2000)(0.5357) = 1071.4$ of the first year students will graduate.

30. $T = \begin{pmatrix} 1 & 0 & 0 & 0 & 0 & 0 & 0 \\ 35/36 & 0 & 1/36 & 0 & 0 & 0 & 0 \\ 0 & 8/9 & 0 & 1/9 & 0 & 0 & 0 \\ 0 & 0 & 3/4 & 0 & 1/4 & 0 & 0 \\ 0 & 0 & 0 & 5/9 & 0 & 4/9 & 0 \\ 0 & 0 & 0 & 0 & 11/36 & 0 & 25/36 \\ 0 & 0 & 0 & 0 & 0 & 0 & 1 \end{pmatrix}$

$p_0 = (0 \ 0 \ 0 \ 1 \ 0 \ 0 \ 0)$; $p_1 = p_0 T = (0 \ 0 \ 3/4 \ 0 \ 1/4 \ 0 \ 0)$

$p_2 = (0 \ 2/3 \ 0 \ 2/9 \ 0 \ 1/9 \ 0)$

Application 2.6

$$1. (a) T = \begin{pmatrix} 0.8 & 0.2 & 0 & 0 & 0 \\ 0.4 & 0.5 & 0.1 & 0 & 0 \\ 0 & 0.4 & 0.5 & 0.1 & 0 \\ 0 & 0 & 0.4 & 0.5 & 0.1 \\ 0 & 0 & 0 & 0.5 & 0.5 \end{pmatrix}; (b) T^4 \text{ has no zeros;}$$

$$(c) (80/133 \ 40/133 \ 10/133 \ 5/266 \ 1/266) \approx (0.6015 \ 0.3008 \ 0.0752 \ 0.0188 \ 0.0036)$$

$$2. \text{ The transition matrix } T \text{ is given by } \begin{pmatrix} 3/10 & 7/10 & 0 & 0 & 0 \\ 9/40 & 3/5 & 7/40 & 0 & 0 \\ 0 & 9/40 & 3/5 & 7/40 & 0 \\ 0 & 0 & 9/40 & 3/5 & 7/40 \\ 0 & 0 & 0 & 3/4 & 1/4 \end{pmatrix}. \text{ As } T^4 \text{ has no zeros, } T \text{ is regular.}$$

The fixed probability vector is approximately $(0.1130 \ 0.3515 \ 0.2737 \ 0.2126 \ 0.0496)$. So for (a), (b), and (c), we have 11.30%, 4.96%, and 21.26%, respectively.

$$3. \text{ The transition matrix } T \text{ is given by } \begin{pmatrix} 3/10 & 7/10 & 0 & 0 & 0 & 0 \\ 9/40 & 3/5 & 7/40 & 0 & 0 & 0 \\ 0 & 9/40 & 3/5 & 7/40 & 0 & 0 \\ 0 & 0 & 9/40 & 3/5 & 7/40 & 0 \\ 0 & 0 & 0 & 9/40 & 3/5 & 7/40 \\ 0 & 0 & 0 & 0 & 3/4 & 1/4 \end{pmatrix}. \text{ As } T^5 \text{ has no zeros, } T \text{ is}$$

regular. The fixed probability vector is approximately $(0.0979 \ 0.3045 \ 0.2368 \ 0.1842 \ 0.1433 \ 0.0344)$. Hence, for (a), (b), and (c), we have 9.79%, 3.44%, and 18.42%.

$$4. T = \begin{matrix} & C & G \\ \begin{matrix} C \\ G \end{matrix} & \begin{pmatrix} 1 & 0 \\ 0.3 & 0.7 \end{pmatrix} \end{matrix}$$

$$5. \mathbf{p}_0 T^3 = (1 - 0.7^3 \ 0.7^3) = (0.657 \ 0.343); 0.657$$

$$6. 0.98 \leq 1 - 0.7^n \text{ gives } n \geq 11. \quad 7. 1/c = 10/3 \text{ guesses}$$

$$8. T = \begin{pmatrix} 0.07 & 0.63 & 0.3 \\ 0.07 & 0.63 & 0.3 \\ 0 & 0 & 0 \end{pmatrix}$$

$$9. R = \begin{pmatrix} 0.07 & 0.63 \\ 0.07 & 0.63 \end{pmatrix}; I - R = \begin{pmatrix} 0.93 & -0.63 \\ -0.07 & 0.37 \end{pmatrix}; (I - R)^{-1} = \begin{pmatrix} 1.2333 & 2.1 \\ 0.2333 & 3.1 \end{pmatrix}; (0.1)(2.1) + (0.9)(3.1) = 3$$

$$10. (0.1)(1.2333) + (0.9)(0.2333) = 0.3333$$

$$11. T = \begin{matrix} & G & K \\ \begin{matrix} G \\ K \end{matrix} & \begin{pmatrix} 0.4 & 0.6 \\ 0 & 1 \end{pmatrix} \end{matrix}$$

$$12. \mathbf{p}_0 T^3 = (1 - 0.6^3 \ 0.6^3) = (0.784 \ 0.216); 0.784$$

$$13. 0.95 \leq 1 - 0.6^n \text{ gives } n \geq 6 \quad 14. 1/c = 2.5 \text{ guesses} \quad 15. T = \begin{pmatrix} 0.15 & 0.45 & 0.4 \\ 0.15 & 0.45 & 0.4 \\ 0 & 0 & 1 \end{pmatrix}$$

$$16. R = \begin{pmatrix} 0.15 & 0.45 \\ 0.15 & 0.45 \end{pmatrix}; (I - R)^{-1} = \begin{pmatrix} 1.375 & 1.125 \\ 0.375 & 2.125 \end{pmatrix}; (0.25)(1.125) + (0.75)(2.125) = 1.875 = 15/8$$

17. $(0.25)(1.375) + (0.75)(0.375) = 0.625 = 5/8$

18. Use induction on n . For $n = 1$, the formula is true. Now suppose that

$$T^k = \begin{pmatrix} c[1 + (1-c) + \dots + (1-c)^{k-1}] & 1 \\ & (1-c)^k \end{pmatrix}^0. \text{ Then } T^{k+1} = T \cdot T^k =$$

$$\begin{pmatrix} c[1 + (1-c) + \dots + (1-c)^k] & 1 \\ & (1-c)^{k+1} \end{pmatrix}^0.$$

19. (a) $xS = x + x^2 + x^3 + \dots + x^n + x^{n+1}$;
 (b) $(1-x)S = 1 - x^{n+1}$
 (c) This follows immediately from part (b)

20. As $(I - R)^{-1} = \frac{1}{cN} \begin{pmatrix} \frac{N - (1-c)(N-1)}{N} & \frac{(1-c)(N-1)}{N} \\ \frac{1-c}{N} & \frac{N - (1-c)}{N} \end{pmatrix}$, then

$$E(G_C) = \frac{1}{cN} \left[\frac{N - (1-c)(N-1)}{N} + \left(1 - \frac{1}{N}\right) (1-c) \right] \text{ and}$$

$$E(G_I) = \frac{1}{cN} \left[\frac{(1-c)(N-1)}{N} + \left(1 - \frac{1}{N}\right) [N - (1-c)] \right]. \text{ Upon adding } E(G_C) \text{ and } E(G_I), \text{ we find}$$

$$E(G_C) + E(G_I) = 1/c = E(G).$$

21. By proof of induction on n . Clearly the formula T^n is true for $n = 1$. Assume the formula holds for $n = k$. Then

$$T^{k+1}T = T^k = \begin{pmatrix} (1-c)/N & (1-c)(1-1/N) & c \\ (1-c)/N & (1-c)(1-1/N) & c \\ 0 & 0 & 1 \end{pmatrix} \times \begin{pmatrix} (1-c)^k/N & (1-1/N)(1-c)^k & 1 - (1-c)^k \\ (1-c)^k/N & (1-1/N)(1-c)^k & 1 - (1-c)^k \\ 0 & 0 & 1 \end{pmatrix}$$

$$= \begin{pmatrix} (1-c)^{k+1}/N^2 + (1-1/N)(1-c)^{k+1}/N & & \\ (1-c)^{k+1}/N^2 + (1-1/N)(1-c)^{k+1}/N & & \\ 0 & & \end{pmatrix}$$

$$\begin{pmatrix} (1-1/N)(1-c)^{k+1}/N + (1-1/N)^2(1-c)^{k+1} & & \\ (1-1/N)(1-c)^{k+1}/N + (1-1/N)^2(1-c)^{k+1} & & \\ 0 & & \end{pmatrix}$$

$$\begin{pmatrix} [(1-c) - (1-c)^{k+1}]/N + (1-1/N)[(1-c)(1-c)^{k+1} + c] & & \\ [(1-c) - (1-c)^{k+1}]/N + (1-1/N)[(1-c)(1-c)^{k+1} + c] & & \\ 0 & & 1 \end{pmatrix}$$

$$= \begin{pmatrix} (1-c)^{k+1}/N & (1-c)^{k+1}(1-1/N) & 1 - (1-c)^{k+1} \\ (1-c)^{k+1}/N & (1-c)^{k+1}(1-1/N) & 1 - (1-c)^{k+1} \\ 0 & 0 & 1 \end{pmatrix}.$$

Review Exercises for Application 2

1. No 2. Yes 3. Yes 4. No 5. Yes
 6. No 7. Yes 8. Yes 9. No
10. (a) $\mathbf{p}_1 = \mathbf{p}_0 T = (2/3 \ 1/3)$; $\mathbf{p}_2 = \mathbf{p}_1 T = (17/36 \ 19/36)$; $\mathbf{p}_3 = \mathbf{p}_2 T = (239/432 \ 193/432)$
 (b) T is regular because all its components are positive.
 (c) $(x \ y) T = (x \ y) \Rightarrow x = 9/17, y = 8/17$
11. (a) $\mathbf{p}_1 = \mathbf{p}_0 T = (1/16 \ 15/16)$; $\mathbf{p}_2 = \mathbf{p}_1 T = (1/128 \ 127/128)$; $\mathbf{p}_3 = \mathbf{p}_2 T = (1/1024 \ 1023/1024)$
 (b) T is not regular.
12. (a) $\mathbf{p}_1 = \mathbf{p}_0 T = (11/20 \ 13/40 \ 1/8)$; $\mathbf{p}_2 = \mathbf{p}_1 T = (55/120 \ 3/16 \ 17/48)$; $\mathbf{p}_3 = \mathbf{p}_2 T = (121/240 \ 41/160 \ 23/96)$
 (b) $T^2 = \begin{pmatrix} 29/60 & 9/40 & 7/24 \\ 17/30 & 21/60 & 1/12 \\ 13/30 & 3/20 & 5/12 \end{pmatrix} \Rightarrow T$ is regular.
 (c) $(x \ y \ z) T = (x \ y \ z) \Rightarrow x = 22/45, y = 7/30, z = 5/18$.
13. (a) $\mathbf{p}_1 = \mathbf{p}_0 T = (1/4 \ 1/3 \ 5/12)$; $\mathbf{p}_2 = \mathbf{p}_1 T = (1/3 \ 3/8 \ 7/24)$; $\mathbf{p}_3 = \mathbf{p}_2 T = (5/16 \ 1/3 \ 17/48)$
 (b) $T^2 = \begin{pmatrix} 1/2 & 1/4 & 1/4 \\ 1/4 & 1/2 & 1/4 \\ 1/4 & 1/4 & 1/2 \end{pmatrix} \Rightarrow T$ is regular.
 (c) $(x \ y \ z) T = (x \ y \ z) \Rightarrow x = 1/3, y = 1/3, z = 1/3$.
14. (a) $\mathbf{p}_1 = \mathbf{p}_0 T = (0.37 \ 0.28 \ 0.35)$; $\mathbf{p}_2 = \mathbf{p}_1 T = (0.333 \ 0.302 \ 0.365)$; $\mathbf{p}_3 = \mathbf{p}_2 T = (0.3397 \ 0.2968 \ 0.3635)$
 (b) T is regular because all its components are positive.
 (c) $(x \ y \ z) T = (x \ y \ z) \Rightarrow x = 47/143, y = 4/11, z = 4/13$.
15. (a) $\mathbf{p}_1 = \mathbf{p}_0 T = (0.246 \ 0.4748 \ 0.2836)$; $\mathbf{p}_2 = \mathbf{p}_1 T = (0.25002 \ 0.47662 \ 0.27336)$; $\mathbf{p}_3 = \mathbf{p}_2 T = (0.2505412 \ 0.4775916 \ 0.2718672)$
 (b) T is regular because all its components are positive.
 (c) $(x \ y \ z) T = (x \ y \ z) \Rightarrow x = 0.250, y = 0.478, z = 0.272$ (to 3 places)
16. The number of absorbing states is 1. $T' = (3/4 \ 1/4)$; $S = (1/4)$; $R = (3/4)$; $Q = (4)$; $A = (1)$.
17. The number of absorbing states is 1. $T' = (1/2 \ 1/2)$; $S = (1/2)$; $R = (1/2)$; $Q = (2)$; $A = (1)$.
18. The number of absorbing states is 1. $T' = \begin{pmatrix} 1/4 & 1/4 & 1/2 \\ 1/3 & 1/3 & 1/3 \end{pmatrix}$; $S = (1/2 \ 1/3)$; $R = \begin{pmatrix} 1/4 & 1/4 \\ 1/3 & 1/3 \end{pmatrix}$; $Q = \begin{pmatrix} 8/5 & 3/5 \\ 4/5 & 9/5 \end{pmatrix}$; $A = \begin{pmatrix} 1 \\ 1 \end{pmatrix}$.
19. There are 2 absorbing states. $T' = (1/5 \ 2/5 \ 2/5)$; $S = (1/5 \ 2/5)$; $R = (2/5)$; $Q = (5/3)$; $A = (1/3 \ 2/3)$.
20. There is one absorbing state. $T' = \begin{pmatrix} 0.6 & 0.3 & 0.1 \\ 0.4 & 0.1 & 0.5 \end{pmatrix}$; $S = (0.3 \ 0.1)$; $R = \begin{pmatrix} 0.6 & 0.1 \\ 0.4 & 0.5 \end{pmatrix}$; $Q = \begin{pmatrix} 3.125 & 0.625 \\ 2.5 & 2.5 \end{pmatrix}$;
 $A = \begin{pmatrix} 1 \\ 1 \end{pmatrix}$.
21. There are 2 absorbing states. $T' = \begin{pmatrix} 1/3 & 1/3 & 1/6 & 1/6 \\ 1/2 & 0 & 1/4 & 1/4 \end{pmatrix}$; $S = \begin{pmatrix} 1/3 & 1/6 \\ 0 & 1/4 \end{pmatrix}$; $R = \begin{pmatrix} 1/3 & 1/6 \\ 1/2 & 1/4 \end{pmatrix}$; $Q = \begin{pmatrix} 9/5 & 2/5 \\ 6/5 & 8/5 \end{pmatrix}$; $A = \begin{pmatrix} 3/5 & 2/5 \\ 2/5 & 3/5 \end{pmatrix}$.

$$22. T' = \begin{pmatrix} 0.13 & 0.34 & 0.25 & 0.28 \\ 0.23 & 0.41 & 0.09 & 0.27 \\ 0.24 & 0.36 & 0.28 & 0.12 \end{pmatrix}; S = \begin{pmatrix} 0.25 \\ 0.09 \\ 0.28 \end{pmatrix}; R = \begin{pmatrix} 0.13 & 0.34 & 0.28 \\ 0.23 & 0.41 & 0.27 \\ 0.24 & 0.36 & 0.12 \end{pmatrix};$$

$$Q = \begin{pmatrix} 1.977 & 1.874 & 1.204 \\ 1.252 & 3.272 & 1.402 \\ 1.051 & 1.850 & 2.038 \end{pmatrix}; A = \begin{pmatrix} 1 \\ 1 \\ 1 \end{pmatrix}. \text{ There is one absorbing state.}$$

$$23. T = \begin{pmatrix} 1 & 0 \\ 0.25 & 0.75 \end{pmatrix}$$

$$24. \mathbf{p}_0 = (0 \ 1); \mathbf{p}_4 = \mathbf{p}_0 T^4 = (1 - (0.75)^4 \ (0.75)^4) = (0.6836 \ 0.3164).$$

25. 17 trials are needed. See example 1 in Application Section 2.6.

26. 4. See example 2 in Application section 2.6.

$$27. T = \begin{pmatrix} 0.0625 & 0.6875 & 0.25 \\ 0.0625 & 0.6875 & 0.25 \\ 0 & 0 & 1 \end{pmatrix}$$

$$28. Q = \begin{pmatrix} 1.25 & 2.75 \\ 0.25 & 3.75 \end{pmatrix}; \text{ Expected number of times to guess incorrectly} = (2.75)(1/12) + (3.5)(11/12) = 11/3$$

$$29. \text{ Expected number of times to guess correctly} = (1.25)(1/12) + (0.25)(11/12) = 1/3$$

$$30. T = \begin{matrix} & \begin{matrix} 0 & 1 & 2 & 3 & 4 \end{matrix} \\ \begin{matrix} 0 \\ 1 \\ 2 \\ 3 \end{matrix} & \begin{pmatrix} 3/5 & 2/5 & 0 & 0 & 0 \\ 2/5 & 7/15 & 2/15 & 0 & 0 \\ 0 & 2/5 & 7/15 & 2/15 & 0 \\ 0 & 0 & 2/5 & 7/15 & 2/15 \\ 0 & 0 & 0 & 2/3 & 1/3 \end{pmatrix} \end{matrix}$$

$$(\mathbf{p}_0 \ \mathbf{p}_1 \ \mathbf{p}_2 \ \mathbf{p}_3 \ \mathbf{p}_4) T = (\mathbf{p}_0 \ \mathbf{p}_1 \ \mathbf{p}_2 \ \mathbf{p}_3 \ \mathbf{p}_4) \Rightarrow \mathbf{p}_0 = \mathbf{p}_1 = \mathbf{p}_2 = \mathbf{p}_3 = \mathbf{p}_4 = 1/5.$$

(a) The teller's line will be empty 20% of the time.

(b) The teller's line will be closed 20% of the time.

$$31. \text{ Strictly determined; } \mathbf{p} = (0 \ 1); \mathbf{q}^t = \begin{pmatrix} 1 \\ 0 \end{pmatrix}.$$

32. Not strictly determined.

$$33. \text{ Strictly determined; } \mathbf{p} = (0 \ 1); \mathbf{q}^t = \begin{pmatrix} 1 \\ 0 \end{pmatrix}.$$

34. Not strictly determined.

$$35. \text{ Strictly determined; } \mathbf{p} = (0 \ 0 \ 1); \mathbf{q}^t = \begin{pmatrix} 0 \\ 0 \\ 1 \end{pmatrix}.$$

$$36. \text{ Strictly determined; } \mathbf{p} = (0 \ 1 \ 0); \mathbf{q}^t = \begin{pmatrix} 1 \\ 0 \\ 0 \end{pmatrix}.$$

$$37. (1/2 \ 1/2) \begin{pmatrix} 6 & 2 \\ 4 & 1 \end{pmatrix} \begin{pmatrix} 3/4 \\ 1/4 \end{pmatrix} = \frac{33}{8}$$

$$38. \begin{pmatrix} 1/3 & 2/3 \end{pmatrix} \begin{pmatrix} 1 & 6 & 2 \\ 3 & -1 & 5 \end{pmatrix} \begin{pmatrix} 1/4 \\ 1/2 \\ 1/4 \end{pmatrix} = \frac{11}{6}$$

$$39. \begin{pmatrix} 1/5 & 2/5 & 2/5 \end{pmatrix} \begin{pmatrix} 1 & 6 & 2 \\ 3 & 0 & -2 \\ 4 & -1 & -6 \end{pmatrix} \begin{pmatrix} 1/2 \\ 0 \\ 1/2 \end{pmatrix} = \frac{1}{10}$$

$$40. \begin{pmatrix} 1 & 0 & 0 \end{pmatrix} \begin{pmatrix} 5 & -1 & 2 \\ 3 & 0 & 4 \\ 6 & 2 & 5 \end{pmatrix} \begin{pmatrix} 1/7 \\ 2/7 \\ 4/7 \end{pmatrix} = \frac{11}{7}$$

$$41. \mathbf{p}_0 = (1 \ 0), \mathbf{q}^t = \begin{pmatrix} 1 \\ 0 \end{pmatrix}, v = 3.$$

$$42. \mathbf{p}_0 = (2/5 \ 3/5), \mathbf{q}_0^t = \begin{pmatrix} 4/5 \\ 1/5 \end{pmatrix}; v = (2/5 \ 3/5) \begin{pmatrix} 3 & 6 \\ 4 & 2 \end{pmatrix} \begin{pmatrix} 4/5 \\ 1/5 \end{pmatrix} = \frac{18}{5}$$

$$43. \mathbf{p}_0 = (3/7 \ 4/7), \mathbf{q}_0^t = \begin{pmatrix} 1/7 \\ 6/7 \end{pmatrix}, v = (3/7 \ 4/7) \begin{pmatrix} -1 & 3 \\ 5 & 2 \end{pmatrix} \begin{pmatrix} 1/7 \\ 6/7 \end{pmatrix} = \frac{17}{7}$$

$$44. \mathbf{p}_0 = (1 \ 0 \ 0), \mathbf{q}_0^t = \begin{pmatrix} 0 \\ 0 \\ 1 \end{pmatrix}, v = 2.$$

$$45. A' = \begin{pmatrix} 3 & -1 \\ -4 & 0 \end{pmatrix}; \mathbf{p}_0 = (1/2 \ 0 \ 1/2); \mathbf{q}_0^t = \begin{pmatrix} 1/8 \\ 7/8 \\ 0 \end{pmatrix}; v = (1/2 \ 1/2) \begin{pmatrix} 3 & -1 \\ -4 & 0 \end{pmatrix} \begin{pmatrix} 1/8 \\ 7/8 \end{pmatrix} = \frac{-1}{2}$$

$$46. A' = \begin{pmatrix} 2 & 8 \\ 3 & 2 \end{pmatrix}; \mathbf{p}_0 = (0 \ 1/7 \ 6/7); \mathbf{q}_0^t = \begin{pmatrix} 0 \\ 6/7 \\ 1/7 \end{pmatrix}; v = (1/7 \ 6/7) \begin{pmatrix} 2 & 8 \\ 3 & 2 \end{pmatrix} \begin{pmatrix} 6/7 \\ 1/7 \end{pmatrix} = \frac{20}{7}$$

$$47. \mathbf{p}_0 = (1/6 \ 5/6 \ 0); \mathbf{q}_0^t = \begin{pmatrix} 1/2 \\ 1/2 \\ 0 \end{pmatrix}; v = 3/2.$$

